

Norsk

design tidende

www.patentstyret.no

Norsk designtidende er en publikasjon som inneholder kunngjøringer innenfor designområdet

BESØKSADRESSE

- ▶ Sandakerveien 64

POSTADRESSE

- ▶ Postboks 4863 Nydalen
0422 Oslo

E-POST

- ▶ post@patentstyret.no

TELEFON

- ▶ +47 22 38 73 00
8.00-15.45

Innholdsfortegnelse:

Meddelelse til søker/innehaver med ukjent adresse	3
Registrerte design	4
Internasjonale designregistreringer	16
Fornyelse av registreringer	178
Overdragelser	181
Endringer i fullmaktsforhold	182
Slettede, utgåtte og opphørte nasjonale designregistreringer.....	183
Slettede, utgåtte og opphørte internasjonale designregistreringer.....	184

INID-koder

I kunngjøringene er de enkelte data forsynt med koder overensstemmende med INID-kodesystemet

(INID= Internationally agreed Numbers for the Identification of Data).

- (11) Registreringsnummer
- (15) Registreringsdato
- (18) Dato som registreringen gjelder til
- (21) Søknadsnummer
- (22) Inngivelsesdato
- (24) Løpedag
- (30) Prioritetsopplysninger
- (43) Allment tilgjengelig dato
- (51) Klasse
- (54) Produkt
- (55) Avbildning(er)
- (72) Designer
- (73) Innehaver
- (74) Fullmektig

Meddelelse til søker/innehaver med ukjent adresse

Meddelelse til innehaver av designregistrering nr. 086009, OK PRODUKTER AS.
Det foreligger avgjørelse om opphør på grunn av ikke betalt fornyelsesavgift i designregistrering nr. 086009.
Avgjørelsen kan fås hos Patentstyret.

Meddelelse til innehaver av designregistrering nr. 086032, Cathrine Hanssen.
Det foreligger avgjørelse om opphør på grunn av ikke betalt fornyelsesavgift i designregistrering nr. 086032.
Avgjørelsen kan fås hos Patentstyret.

Registrerte design

I henhold til designloven § 18 første ledd i.f. kunngjøres i dag følgende registrerte design.

Det kan fremsettes krav om at designregistreringen helt eller delvis skal oppheves, jf. designloven §§ 25 flg. og designforskriften §§ 26 flg.

Designregistreringen gjelder for den eller de periodene på fem år som søknaden er innlevert for, regnet fra søknadsdagen. Registreringen kan fornyes, jf. designloven §§ 23 og 24. Maksimal beskyttelsestid er 25 år. For reservedeler, se unntaket i designloven § 23 annet ledd.

(11)	Reg.nr.:	087849
(21)	Søkn.nr.:	20230964
(22)	Inngitt:	2023.09.19
(24)	Løpedag:	2023.09.19
(43)	Allm. tilgj.:	2023.09.19
(15)	Registrert:	2024.01.08
(45)	Kunngjort:	2024.02.05
(18)	Reg. gjelder til:	2028.09.19
(73)	Innehaver:	Apple Inc., One Apple Park Way, CA95014 CUPERTINO, USA
(74)	Fullmektig:	BRYN AARFLOT AS, Stortingsgata 8, 0161 OSLO, Norge
(50)	Anmerkninger:	Registreringen gjelder samregistrering

Design 1

(54)	Produkt:	Smarttelefon
(51)	Klasse:	14-03
(30)	Prioritet:	2023.04.28, US, 29/890,997, 1, 2
(55)	Designavbildninger:	

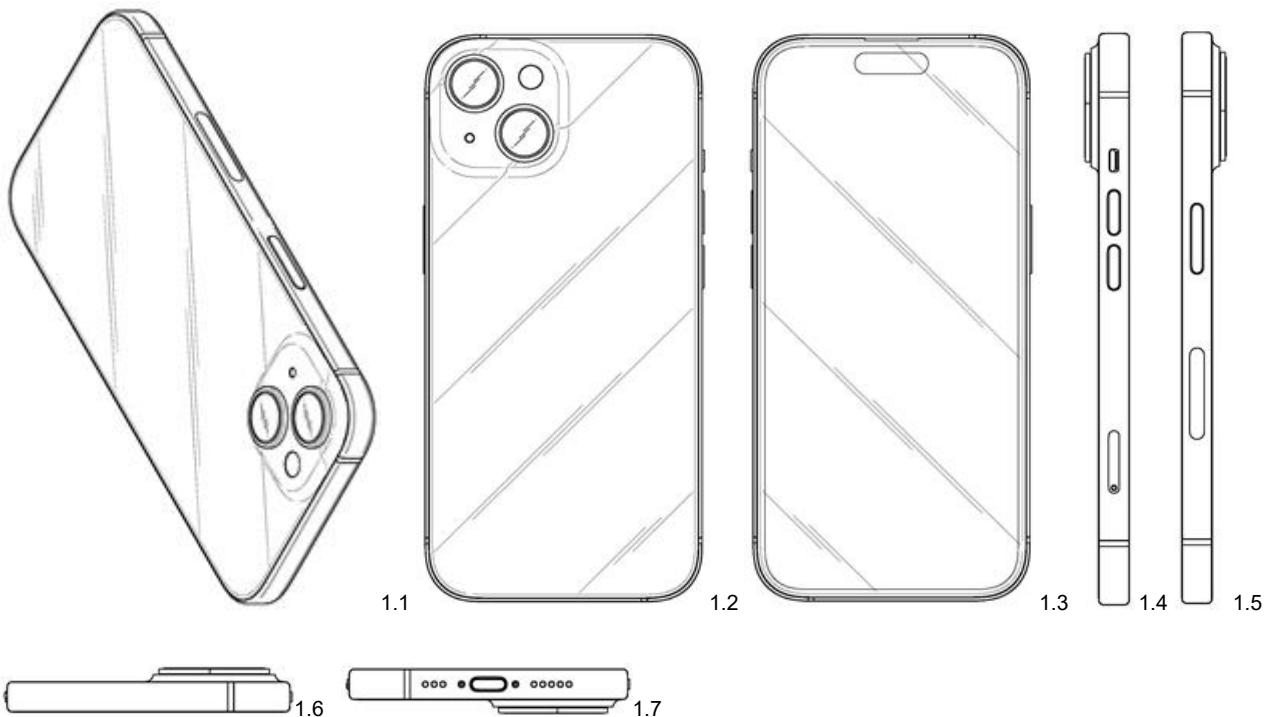

Design 2

- (54) **Produkt:** Smarttelefon
(51) **Klasse:** 14-03
(30) **Prioritet:** 2023.04.28, US, 29/890,997, 1, 2
(55) **Designavbildninger:**

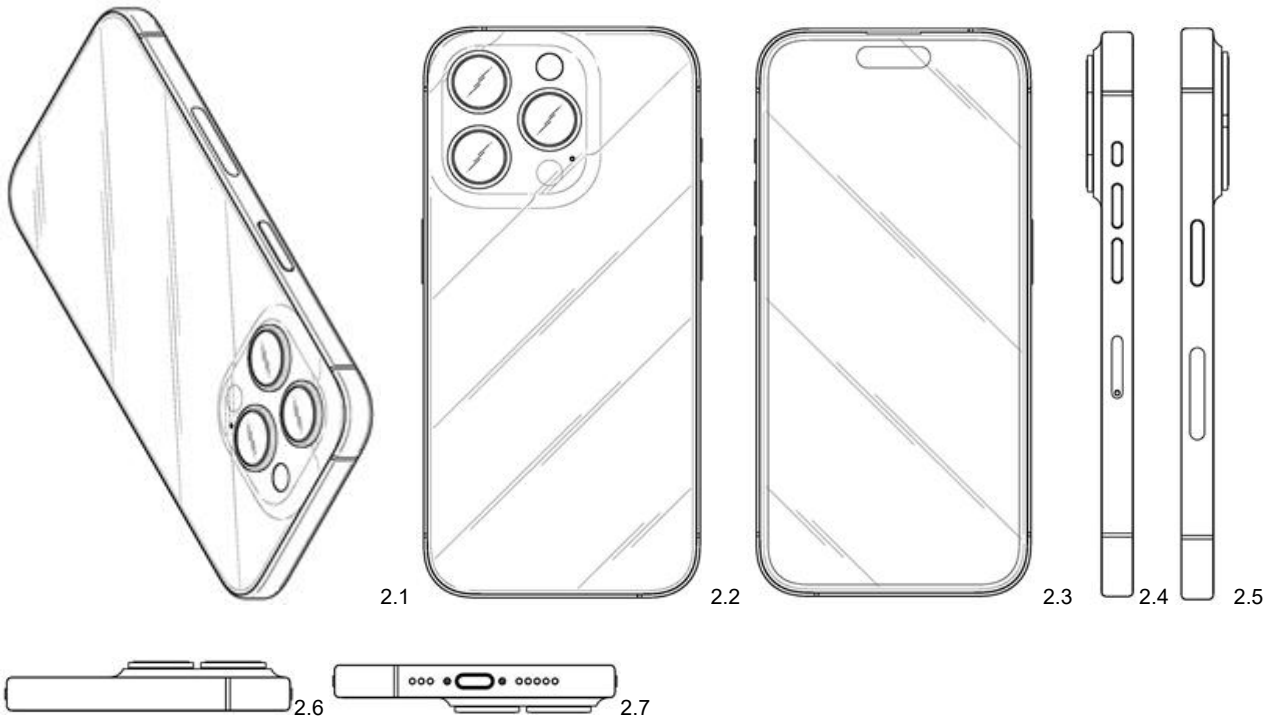

- (11) **Reg.nr.:** 087850
(21) **Søkn.nr.:** 20231002
(22) **Inngitt:** 2023.10.04
(24) **Løpedag:** 2023.10.04
(43) **Allm. tilgj.:** 2023.10.05
(15) **Registrert:** 2024.01.10
(45) **Kunngjort:** 2024.02.05
(18) **Reg. gjelder til:** 2028.10.04
(73) **Innehaver:** Exani Holding AB, Skaraborgsgatan 49, 53237 SKARA, Sverige
(74) **Fullmektig:** ZACCO NORWAY AS, Postboks 488, 0213 OSLO, Norge
(50) **Anmerkninger:** Registreringen gjelder samregistrering

Design 1

- (54) **Produkt:** Sandal
(51) **Klasse:** 02-04
(30) **Prioritet:** 2023.04.05, EM, 015017044, 1, 2
(55) **Designavbildninger:**



1.1



1.2



1.3



1.4



1.5



1.6



1.7

Design 2

- (54) **Produkt:** Del av sandal
(51) **Klasse:** 02-04
(30) **Prioritet:** 2023.04.05, EM, 015017044, 1, 2
(55) **Designavbildninger:**



2.1



2.2



2.3



2.4



2.5

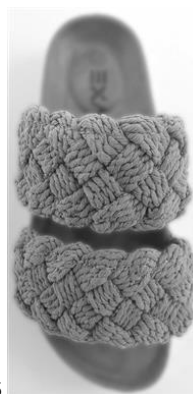

2.6



2.7

- (11) **Reg.nr.:** 087851
(21) **Søkn.nr.:** 20231162
(22) **Inngitt:** 2023.11.15
(24) **Løpedag:** 2023.11.15
(43) **Allm. tilgj.:** 2023.11.25
(15) **Registrert:** 2024.01.10
(45) **Kunngjort:** 2024.02.05
(18) **Reg. gjelder til:** 2028.11.15
(73) **Innehaver:** BLUESUN CONSUMER BRANDS, S.L., VILASSAR, 5 POL. IND. "EL RENGLE", 08302 BARCELONA, Spania
(74) **Fullmektig:** BRYN AARFLOT AS, Stortingsgata 8, 0161 OSLO, Norge

Design 1

- (54) **Produkt:** Målebeger
(51) **Klasse:** 10-04
(30) **Prioritet:** 2023.05.25, EM, 015022474, 1
(55) **Designavbildninger:**

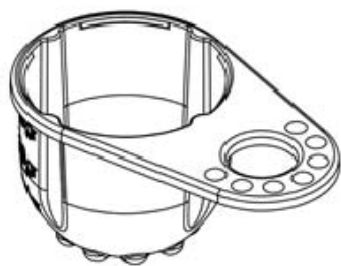

1.1

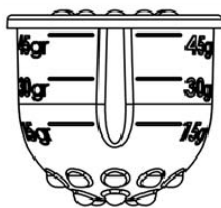

1.2

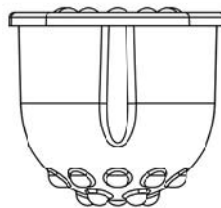

1.3

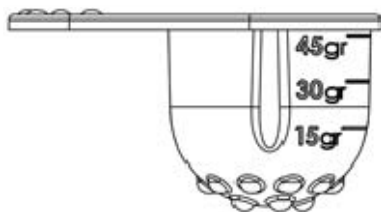

1.4

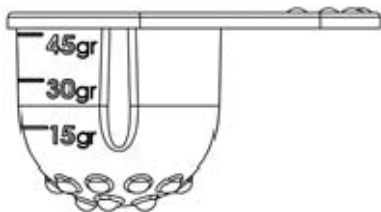

1.5

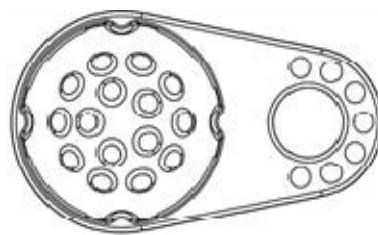

1.6

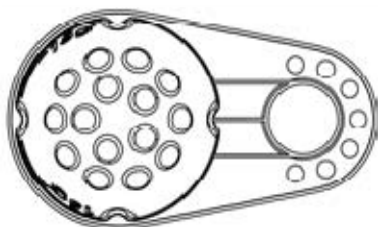

1.7

(11)	Reg.nr.:	087852
(21)	Søkn.nr.:	20230857
(22)	Inngitt:	2023.08.22
(24)	Løpedag:	2023.08.22
(43)	Allm. tilgj.:	2024.01.06
(15)	Registrert:	2024.01.10
(45)	Kunngjort:	2024.02.05
(18)	Reg. gjelder til:	2028.08.22
(73)	Innehaver:	HOT SPOT TECHNOLOGY Ltd, 6D Hoi Hai Cial Bldg 44 d'aguilar street, HONG KONG, Kina
(74)	Fullmektig:	ONSAGERS AS, Postboks 1813, Vikå, 0123 OSLO, Norge

Design 1

(54)	Produkt:	Hånddreven matprosessor
(51)	Klasse:	07-04
(72)	Designer:	Jiawei SUN, QinshiIndustrial Zone, No.33 Sanzao Town, ZHUHAI, GUANGDONG PROVINCE, Kina
(30)	Prioritet:	2023.07.06, EM, 0150272180001, 1
(55)	Designavbildninger:	

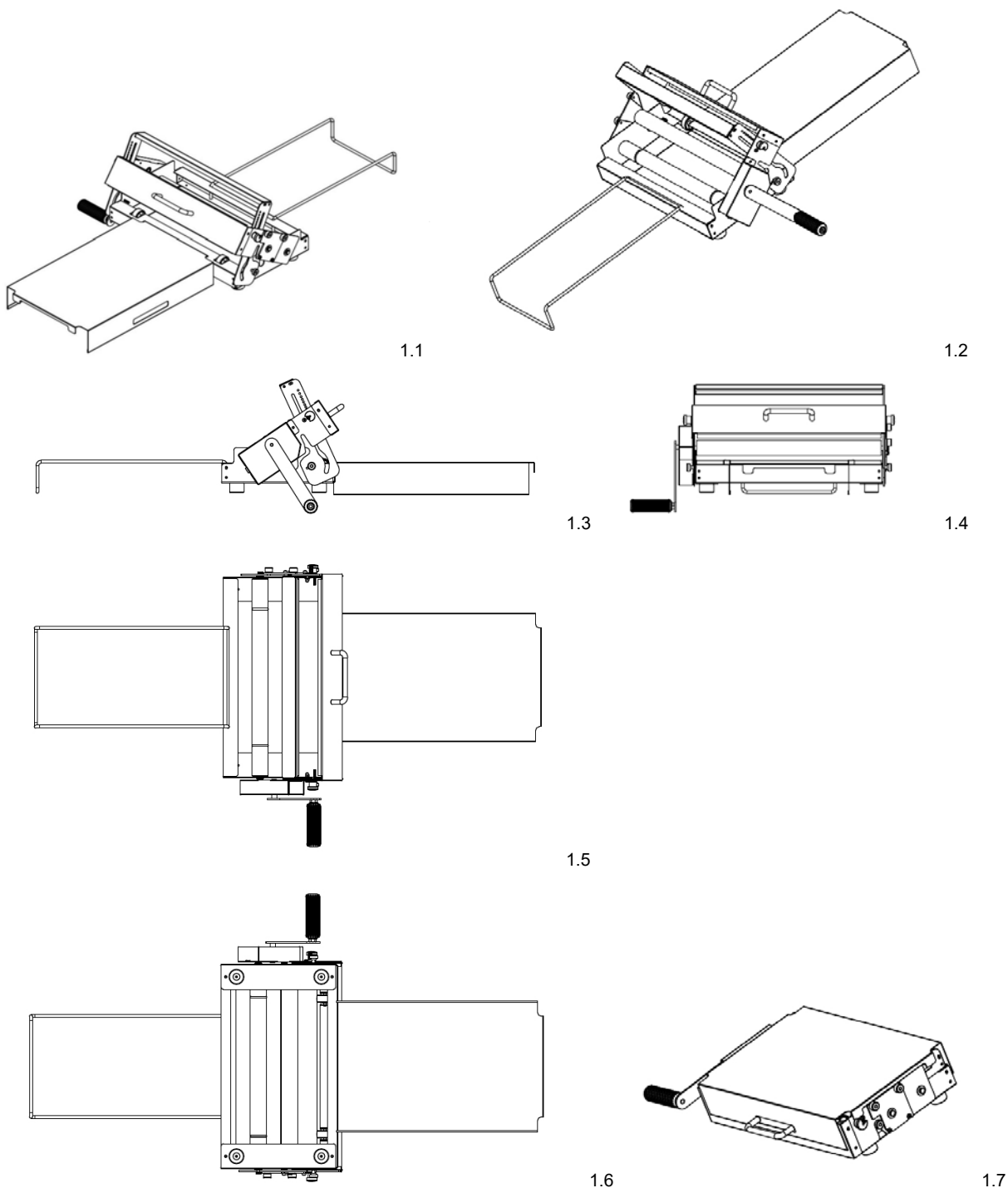

- (11) **Reg.nr.:** 087853
(21) **Søkn.nr.:** 20230576
(22) **Inngitt:** 2023.06.04
(24) **Løpedag:** 2023.06.04
(43) **Allm. tilgj.:** 2023.12.04
(15) **Registrert:** 2024.01.11
(45) **Kunngjort:** 2024.02.05
(18) **Reg. gjelder til:** 2028.06.04
(73) **Innehaver:** Bjarte Synnevåg, ØRNAHAUGEN 73, 5144 FYLLINGSDALEN, Norge

Design 1

- (54) **Produkt:** Sagkrakk
(51) **Klasse:** 08-99
(72) **Designer:** Bjarte Synnevåg, ØRNAHAUGEN 73, 5144 FYLLINGSDALEN
Anmerkninger:
(57) **Design i farger:** Ja
(50) **Annet:** Fig. 1.5, 1.6 og 1.7 viser sprengskisser.
(55) **Designavbildninger:**



1.1



1.2



1.3



1.4



1.5



1.6



1.7

- (11) **Reg.nr.:** 087854
(21) **Søkn.nr.:** 20230920
(22) **Inngitt:** 2023.09.13
(24) **Løpedag:** 2023.09.13
(43) **Allm. tilgj.:** 2023.10.05
(15) **Registrert:** 2024.01.11
(45) **Kunngjort:** 2024.02.05
(18) **Reg. gjelder til:** 2028.09.13
(73) **Innehaver:** FM Mattsson AB, Box 480, 79227 MORA, Sverige
(74) **Fullmektig:** ACAPO AS, Edvard Griegs vei 1, 5059 BERGEN, Norge
(50) **Anmerkninger:** Registreringen gjelder samregistrering

Design 1

- (54) **Produkt:** Blandebatteri
(51) **Klasse:** 23-01
(30) **Prioritet:** 2023.04.05, EM, 015017159, 1, 2, 3, 4, 5, 6
(55) **Designavbildninger:**

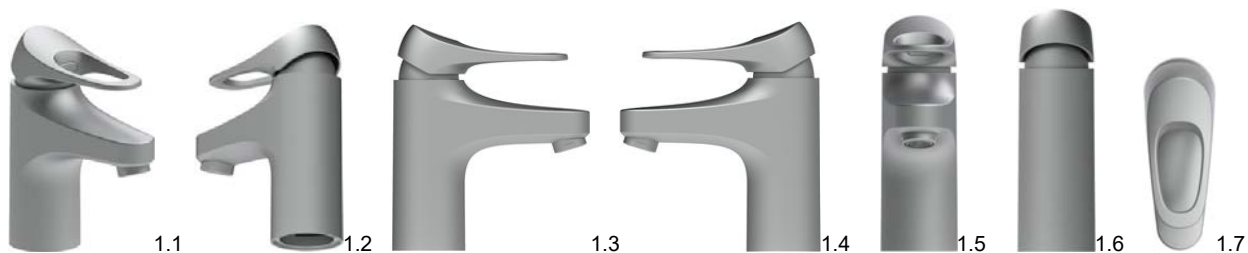
**Design 2**

- (54) **Produkt:** Blandebatteri
(51) **Klasse:** 23-01
(30) **Prioritet:** 2023.04.05, EM, 015017159, 1, 2, 3, 4, 5, 6
(55) **Designavbildninger:**

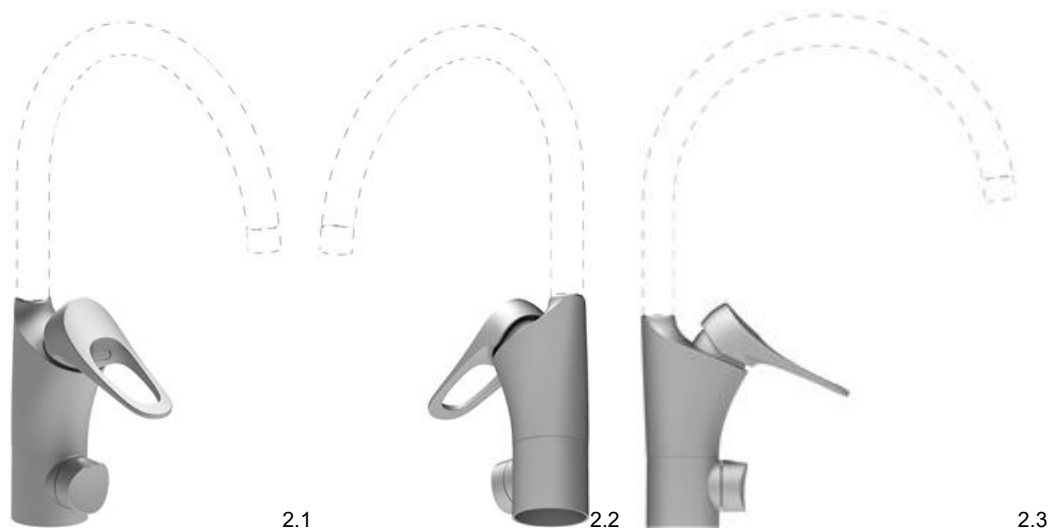

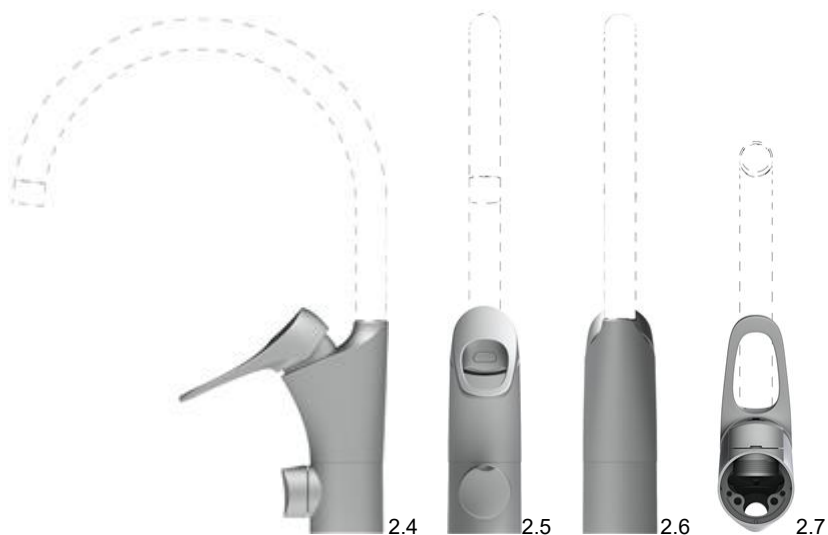

Design 3

(54) **Produkt:** Blandebatteri
 (51) **Klasse:** 23-01
 (30) **Prioritet:** 2023.04.05, EM, 015017159, 1, 2, 3, 4, 5, 6
 (55) **Designavbildninger:**

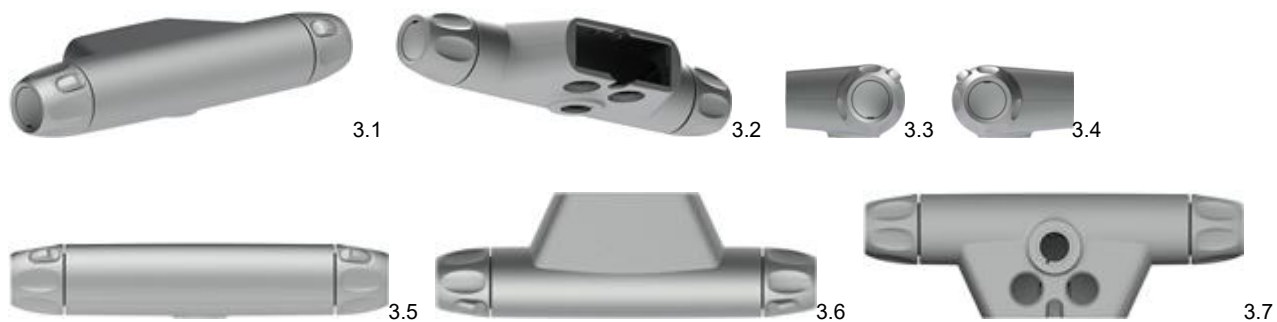

Design 4

(54) **Produkt:** Blandebatteri
 (51) **Klasse:** 23-01
 (30) **Prioritet:** 2023.04.05, EM, 015017159, 1, 2, 3, 4, 5, 6
 (55) **Designavbildninger:**

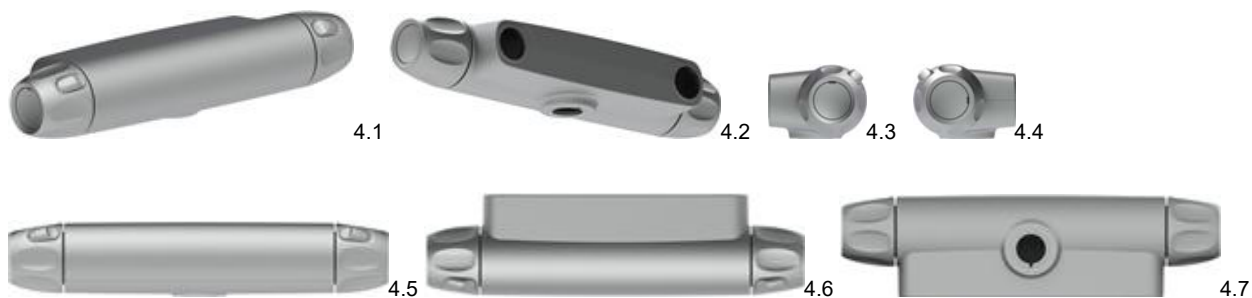

Design 5

- (54) **Produkt:** Håndtak til baderomskraner
(51) **Klasse:** 23-01
(30) **Prioritet:** 2023.04.05, EM, 015017159, 1, 2, 3, 4, 5, 6
(55) **Designavbildninger:**

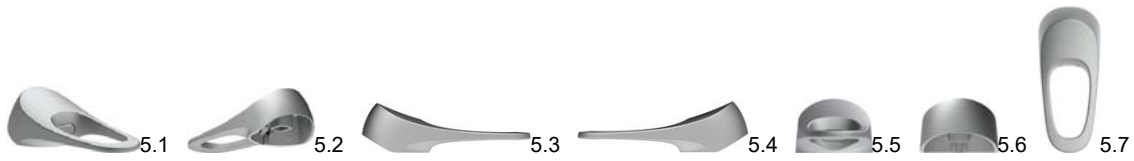
**Design 6**

- (54) **Produkt:** Håndtak til baderomskraner
(51) **Klasse:** 23-01
(30) **Prioritet:** 2023.04.05, EM, 015017159, 1, 2, 3, 4, 5, 6
(55) **Designavbildninger:**

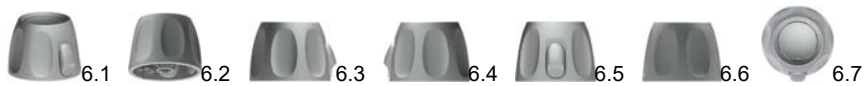

- (11) **Reg.nr.:** 087855
(21) **Søkn.nr.:** 20231238
(22) **Inngitt:** 2023.11.20
(24) **Løpedag:** 2023.09.27
(43) **Allm. tilgj.:** 2023.09.30
(15) **Registrert:** 2024.01.15
(45) **Kunngjort:** 2024.02.05
(18) **Reg. gjelder til:** 2028.09.27
(73) **Innehaver:** INDUVITA AS, Parkveien 95, 8005 BODØ, Norge

Design 1

- (54) **Produkt:** Spekulum for vaginalundersøkelse
(51) **Klasse:** 24-02
(72) **Designer:** Stine Andreassen, Sløyfa 22, 8072 BODØ
Hege Hansen, Fredensborgveien 175, 8002 BODØ
(55) **Designavbildninger:**



1.1



1.2



1.3



1.4

- (11) **Reg.nr.:** 087856
(21) **Søkn.nr.:** 20231117
(22) **Inngitt:** 2023.10.31
(24) **Løpedag:** 2023.10.31
(43) **Allm. tilgj.:** 2023.10.31
(15) **Registrert:** 2024.01.17
(45) **Kunngjort:** 2024.02.05
(18) **Reg. gjelder til:** 2028.10.31
(73) **Innehaver:** Sundlings Sverige AB, Jungmansgatan 16, 53140 LIDKÖPING, Sverige
(74) **Fullmektig:** Advokatfirman MarLaw AB, Box 3079, 10361 STOCKHOLM, Sverige

Design 1

- (54) **Produkt:** Ornamentering
(51) **Klasse:** 32-01
(72) **Designer:** Sundlings Sverige AB, Jungmansgatan 16, 53140 LIDKÖPING, Sverige
Anmerkninger:
(57) **Design i farger:** Ja
(55) **Designavbildninger:**



1.1

Internasjonale designregistreringer

I henhold til designloven § 57 fjerde ledd, kunngjøres i dag følgende internasjonale registreringer som har virkning i Norge.

Det kan fremsettes krav om at designregistreringen helt eller delvis skal oppheves, jf. designloven §§ 58 fjerde ledd og 25 flg. og designforskriften §§ 26 flg.

Virkingen av en internasjonal registrering gjelder for den eller de periodene på fem år som søknaden er innlevert for, regnet fra den dagen registreringen ved det Internasjonale byrået anses å ha skjedd. Registreringen kan fornyes etter bestemmelsene i Genèveavtalen, se dl § 58 tredje ledd. Maksimal beskyttelsestid er 25 år.

(11)	Reg.nr.:	DM/226314
(21)	Søkn.nr.:	20230144
(22)	Inngitt i WIPO:	2022.12.23
(15)	Registrert i WIPO:	2022.12.23
(24)	Løpedag:	2022.12.23
(43)	Allm. tilgj.:	2023.12.29
(15)	Besluttet gjeldende NO:	2024.01.17
(45)	Kunngjort NO:	2024.02.05
(18)	Reg. gjelder til:	2027.12.23
(73)	Innehaver:	INFINIRI AG, Mariahilfgasse 2a, 6004 LUZERN, Sveits
(50)	Anmerkninger:	Registreringen gjelder samregistrering

Design 1

(54)	Produkt:	Sock
(51)	Klasse:	02-04
(72)	Designer:	Ian Echlin, Reusssteg 9, 6003 LUZERN, Sveits
(55)	Designavbildninger:	



1.1



1.2



1.3



1.4



1.5



1.6

Design 2

- (54) **Produkt:** Sock
(51) **Klasse:** 02-04
(72) **Designer:** Ian Echlin, Reusssteg 9, 6003 LUZERN, Sveits
(55) **Designavbildninger:**



2.1



2.2



2.3



2.4



2.5



2.6

Design 3

- (54) **Produkt:** Sock
(51) **Klasse:** 02-04
(72) **Designer:** Ian Echlin, Reusssteg 9, 6003 LUZERN, Sveits
(55) **Designavbildninger:**



3.1



3.2



3.3



3.4



3.5



3.6

Design 4

- (54) **Produkt:** Sock
- (51) **Klasse:** 02-04
- (72) **Designer:** Ian Echlin, Reusssteg 9, 6003 LUZERN, Sveits
- (55) **Designavbildninger:**



4.1



4.2



4.3



4.4



4.5



4.6

Design 5

- (54) **Produkt:** Sock
- (51) **Klasse:** 02-04
- (72) **Designer:** Ian Echlin, Reusssteg 9, 6003 LUZERN, Sveits
- (55) **Designavbildninger:**



5.1



5.2



5.3



5.4



5.5



5.6

Design 6

- (54) **Produkt:** Sock
(51) **Klasse:** 02-04
(72) **Designer:** Ian Echlin, Reusssteg 9, 6003 LUZERN, Sveits
(55) **Designavbildninger:**



6.1



6.2



6.3



6.4



6.5



6.6

Design 7

- (54) **Produkt:** Sock
(51) **Klasse:** 02-04
(72) **Designer:** Ian Echlin, Reusssteg 9, 6003 LUZERN, Sveits
(55) **Designavbildninger:**



7.1



7.2



7.3



7.4



7.5



7.6

Design 8

- (54) **Produkt:** Sock
 (51) **Klasse:** 02-04
 (72) **Designer:** Ian Echlin, Reusssteg 9, 6003 LUZERN, Sveits
 (55) **Designavbildninger:**



8.1



8.2



8.3



8.4



8.5



8.6

Design 9

- (54) **Produkt:** Sock
 (51) **Klasse:** 02-04
 (72) **Designer:** Ian Echlin, Reusssteg 9, 6003 LUZERN, Sveits
 (55) **Designavbildninger:**



9.1



9.2



9.3



9.4



9.5



9.6

Design 10

(54) **Produkt:** Sock
 (51) **Klasse:** 02-04
 (72) **Designer:** Ian Echlin, Reusssteg 9, 6003 LUZERN, Sveits
 (55) **Designavbildninger:**



10.1



10.2



10.3



10.4



10.5



10.6

Design 11

(54) **Produkt:** Sock
 (51) **Klasse:** 02-04
 (72) **Designer:** Ian Echlin, Reusssteg 9, 6003 LUZERN, Sveits
 (55) **Designavbildninger:**



11.1



11.2



11.3



11.4



11.5



11.6

Design 12

(54) **Produkt:** Sock
(51) **Klasse:** 02-04
(72) **Designer:** Ian Echlin, Reusssteg 9, 6003 LUZERN, Sveits
(55) **Designavbildninger:**



12.1



12.2



12.3



12.4



12.5



12.6

Design 13

(54) **Produkt:** Sock
(51) **Klasse:** 02-04
(72) **Designer:** Ian Echlin, Reusssteg 9, 6003 LUZERN, Sveits
(55) **Designavbildninger:**



13.1



13.2



13.3



13.4



13.5



13.6

Design 14

(54) **Produkt:** Sock
 (51) **Klasse:** 02-04
 (72) **Designer:** Ian Echlin, Reusssteg 9, 6003 LUZERN, Sveits
 (55) **Designavbildninger:**



14.1



14.2



14.3



14.4



14.5

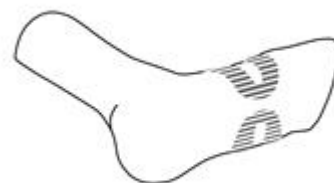

14.6

Design 15

(54) **Produkt:** Sock
 (51) **Klasse:** 02-04
 (72) **Designer:** Ian Echlin, Reusssteg 9, 6003 LUZERN, Sveits
 (55) **Designavbildninger:**



15.1



15.2



15.3



15.4



15.5

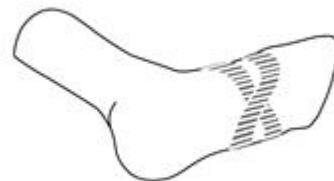

15.6

Design 16

- (54) **Produkt:** Sock
(51) **Klasse:** 02-04
(72) **Designer:** Ian Echlin, Reusssteg 9, 6003 LUZERN, Sveits
(55) **Designavbildninger:**



16.1



16.2



16.3

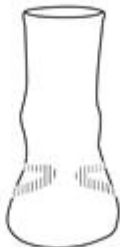

16.4



16.5

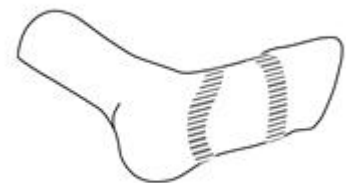

16.6

Design 17

- (54) **Produkt:** Sock
(51) **Klasse:** 02-04
(72) **Designer:** Ian Echlin, Reusssteg 9, 6003 LUZERN, Sveits
(55) **Designavbildninger:**



17.1



17.2



17.3



17.4



17.5

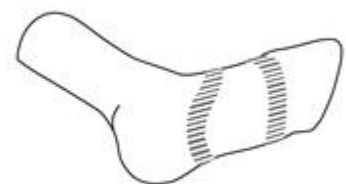

17.6

Design 18

(54) **Produkt:** Sock
 (51) **Klasse:** 02-04
 (72) **Designer:** Ian Echlin, Reusssteg 9, 6003 LUZERN, Sveits
 (55) **Designavbildninger:**



18.1



18.2



18.3



18.4



18.5

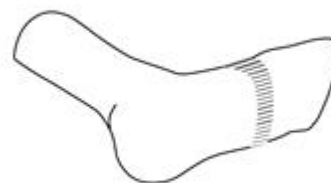

18.6

Design 19

(54) **Produkt:** Sock
 (51) **Klasse:** 02-04
 (72) **Designer:** Ian Echlin, Reusssteg 9, 6003 LUZERN, Sveits
 (55) **Designavbildninger:**



19.1



19.2



19.3



19.4



19.5



19.6

Design 20

(54) **Produkt:** Sock
 (51) **Klasse:** 02-04
 (72) **Designer:** Ian Echlin, Reusssteg 9, 6003 LUZERN, Sveits
 (55) **Designavbildninger:**



20.1



20.2



20.3



20.4



20.5



20.6

Design 21

(54) **Produkt:** Pair of socks
 (51) **Klasse:** 02-04
 (72) **Designer:** Ian Echlin, Reusssteg 9, 6003 LUZERN, Sveits
 (55) **Designavbildninger:**



21.1

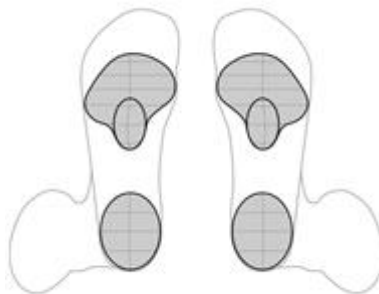

21.2



21.3

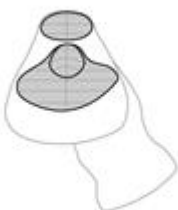

21.4



21.5



21.6

Design 22

(54) **Produkt:** Pair of socks
 (51) **Klasse:** 02-04
 (72) **Designer:** Ian Echlin, Reusssteg 9, 6003 LUZERN, Sveits
 (55) **Designavbildninger:**



22.1

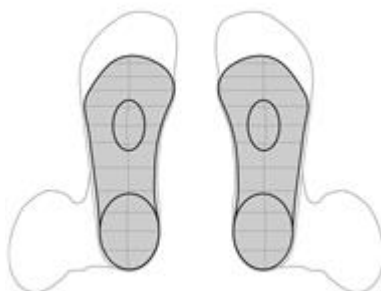

22.2



22.3

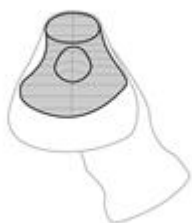

22.4



22.5



22.6

Design 23

(54) **Produkt:** Pair of socks
 (51) **Klasse:** 02-04
 (72) **Designer:** Ian Echlin, Reusssteg 9, 6003 LUZERN, Sveits
 (55) **Designavbildninger:**

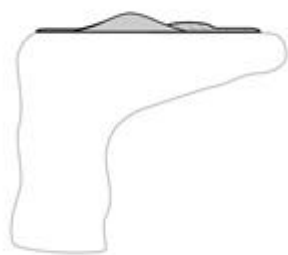

23.1

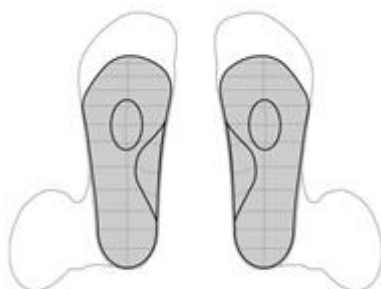

23.2



23.3

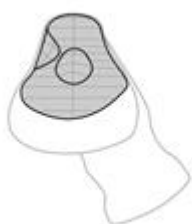

23.4

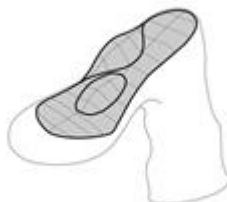

23.5



23.6

Design 24

(54) **Produkt:** Pair of socks
 (51) **Klasse:** 02-04
 (72) **Designer:** Ian Echlin, Reusssteg 9, 6003 LUZERN, Sveits
 (55) **Designavbildninger:**



24.1



24.2



24.3



24.4



24.5



24.6

Design 25

(54) **Produkt:** Pair of socks
 (51) **Klasse:** 02-04
 (72) **Designer:** Ian Echlin, Reusssteg 9, 6003 LUZERN, Sveits
 (55) **Designavbildninger:**

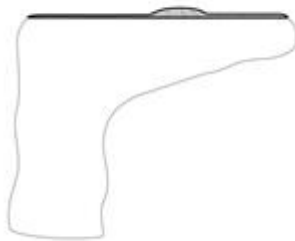

25.1

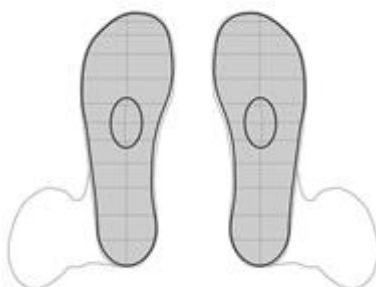

25.2



25.3

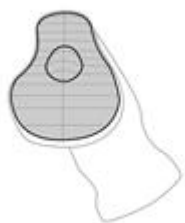

25.4

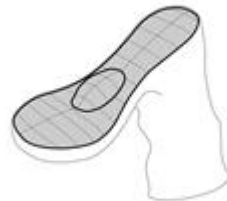

25.5



25.6

Design 26

(54) **Produkt:** Pair of socks
(51) **Klasse:** 02-04
(72) **Designer:** Ian Echlin, Reusssteg 9, 6003 LUZERN, Sveits
(55) **Designavbildninger:**



26.1

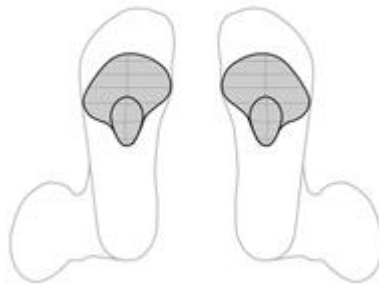

26.2



26.3

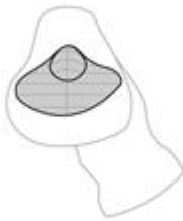

26.4

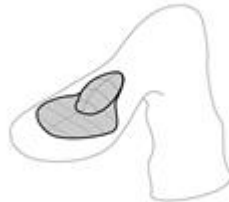

26.5



26.6

(11)	Reg.nr.:	DM/226441
(21)	Søkn.nr.:	20230242
(22)	Inngitt i WIPO:	2022.12.27
(15)	Registrert i WIPO:	2022.12.27
(24)	Løpedag:	2022.12.27
(43)	Allm. tilgj.:	2023.12.29
(15)	Besluttet gjeldende NO:	2024.01.18
(45)	Kunngjort NO:	2024.02.05
(18)	Reg. gjelder til:	2027.12.27
(73)	Innehaver:	Hansgrohe SE, Auestrasse 5 - 9, 77761 SCHILTACH, Tyskland
(50)	Anmerkninger:	Registreringen gjelder samregistrering

Design 1

(54)	Produkt:	Washbasin
(51)	Klasse:	23-06
(72)	Designer:	Laura Somaglino, Hahilingastr. 44, 82041 OBERHACHING, Sveits
(30)	Prioritet:	2022.07.21, EM, 009094048, 1,2,3,4
(55)	Designavbildninger:	

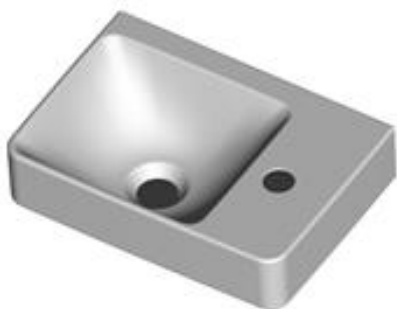

1.1



1.2



1.3



1.4



1.5



1.6



1.7

Design 2

(54) **Produkt:** Washbasin
(51) **Klasse:** 23-06
(72) **Designer:** Laura Somaglino, Hahilingastr. 44, 82041 OBERHACHING, Sveits
(30) **Prioritet:** 2022.07.21, EM, 009094048, 1,2,3,4
(55) **Designavbildninger:**



2.1



2.2



2.3



2.4



2.5



2.6



2.7

Design 3

(54) **Produkt:** Washbasin
(51) **Klasse:** 23-06
(72) **Designer:** Laura Somaglino, Hahilingastr. 44, 82041 OBERHACHING, Sveits
(30) **Prioritet:** 2022.07.21, EM, 009094048, 1,2,3,4
(55) **Designavbildninger:**



3.1



3.2



3.3



3.4



3.5



3.6



3.7

Design 4

(54) **Produkt:** Washbasin
(51) **Klasse:** 23-06
(72) **Designer:** Laura Somaglino, Hahilingastr. 44, 82041 OBERHACHING, Sveits
(30) **Prioritet:** 2022.07.21, EM, 009094048, 1,2,3,4
(55) **Designavbildninger:**



4.1



4.2



4.3



4.4



4.5



4.6



4.7

(11)	Reg.nr.:	DM/226442
(21)	Søkn.nr.:	20230243
(22)	Inngitt i WIPO:	2022.12.27
(15)	Registrert i WIPO:	2022.12.27
(24)	Løpedag:	2022.12.27
(43)	Allm. tilgj.:	2023.12.29
(15)	Besluttet gjeldende NO:	2024.01.18
(45)	Kunngjort NO:	2024.02.05
(18)	Reg. gjelder til:	2027.12.27
(73)	Innehaver:	Hansgrohe SE, Auestrasse 5 - 9, 77761 SCHILTACH, Tyskland
(50)	Anmerkninger:	Registreringen gjelder samregistrering

Design 1

(54)	Produkt:	Washbasin
(51)	Klasse:	23-06
(72)	Designert:	Laura Somaglino, Hahilingastr. 44, 82041 OBERHACHING, Tyskland
(30)	Prioritet:	2022.07.27, EM, 009099617, 1,2,3
(55)	Designavbildninger:	



1.1



1.2



1.3



1.4



1.5



1.6

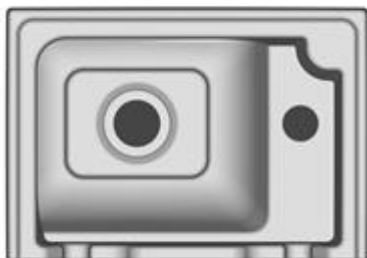

1.7

Design 2

- (54) **Produkt:** Washbasin
- (51) **Klasse:** 23-06
- (72) **Designer:** Laura Somaglino, Hahilingastr. 44, 82041 OBERHACHING, Tyskland
- (30) **Prioritet:** 2022.07.27, EM, 009099617, 1,2,3
- (55) **Designavbildninger:**



2.1



2.2



2.3



2.4



2.5



2.6

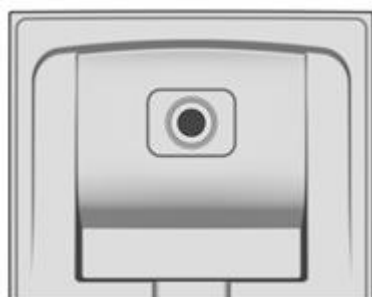

2.7

Design 3

(54) **Produkt:** Washbasin
(51) **Klasse:** 23-06
(72) **Designer:** Laura Somaglino, Hahilingastr. 44, 82041 OBERHACHING, Tyskland
(30) **Prioritet:** 2022.07.27, EM, 009099617, 1,2,3
(55) **Designavbildninger:**



3.1



3.2



3.3

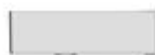

3.4



3.5



3.6



3.7

(11) Reg.nr.:	DM/226507
(21) Søkn.nr.:	20230246
(22) Inngitt i WIPO:	2023.01.05
(15) Registrert i WIPO:	2023.01.05
(24) Løpedag:	2023.01.05
(43) Allm. tilgj.:	2024.01.05
(15) Besluttet gjeldende NO:	2024.01.09
(45) Kunngjort NO:	2024.02.05
(18) Reg. gjelder til:	2028.01.05
(73) Innehaver:	L'OREAL (U.K.) Limited, Hammersmith Road 255, W68AZ LONDON, Storbritannia

Design 1

(54) Produkt:	Cosmetics applicator
(51) Klasse:	28-02
(72) Designer:	Charlotte CLABAUX, L'ORÉAL, 9 rue Pierre Dreyfus, 92110 CLICHY, Frankrike Marcel SANCHEZ, L'ORÉAL, 9 rue Pierre Dreyfus, 92110 CLICHY, Frankrike
(55) Designavbildninger:	

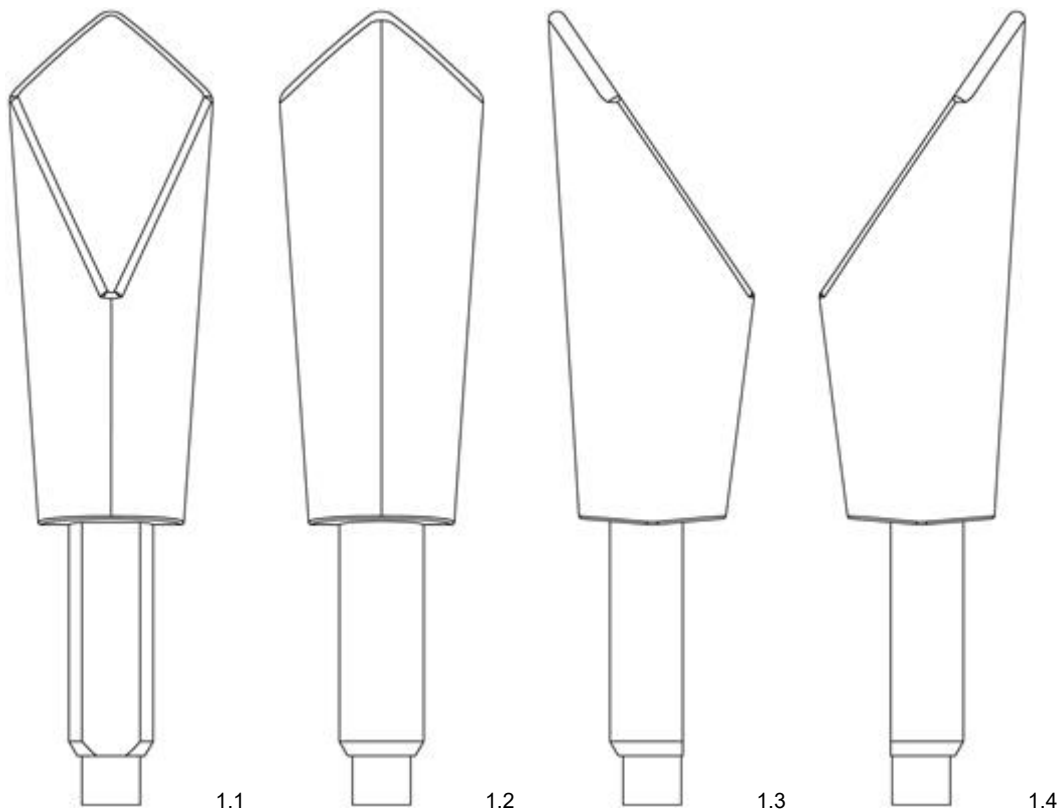

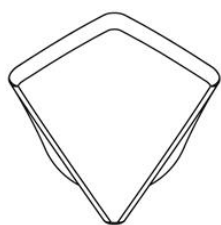

1.5

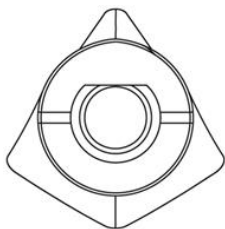

1.6

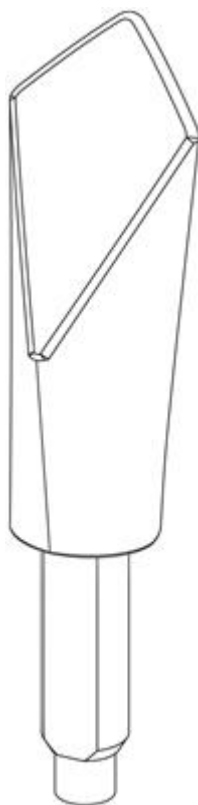

1.7

(11)	Reg.nr.:	DM/227173
(21)	Søkn.nr.:	20230364
(22)	Inngitt i WIPO:	2023.01.05
(15)	Registrert i WIPO:	2023.01.05
(24)	Løpedag:	2023.01.05
(43)	Allm. tilgj.:	2024.01.05
(15)	Besluttet gjeldende NO:	2024.01.09
(45)	Kunngjort NO:	2024.02.05
(18)	Reg. gjelder til:	2028.01.05
(73)	Innehaver:	Sourhouse LLC, 65 Merrimon Avenue, #1111, NC28801 ASHEVILLE, USA

Design 1

(54)	Produkt:	Fermenting chamber for baking
(51)	Klasse:	31-00
(72)	Designer:	Erik Fabian, c/o Sourhouse LLC 65 Merrimon Avenue #1111, NC28801 ASHEVILLE, USA Jennifer Yoko Olson, c/o Sourhouse LLC 65 Merrimon Avenue #1111, NC28801 ASHEVILLE, USA
(30)	Prioritet:	2022.07.15, US, 29/865,246, 1
(55)	Designavbildninger:	

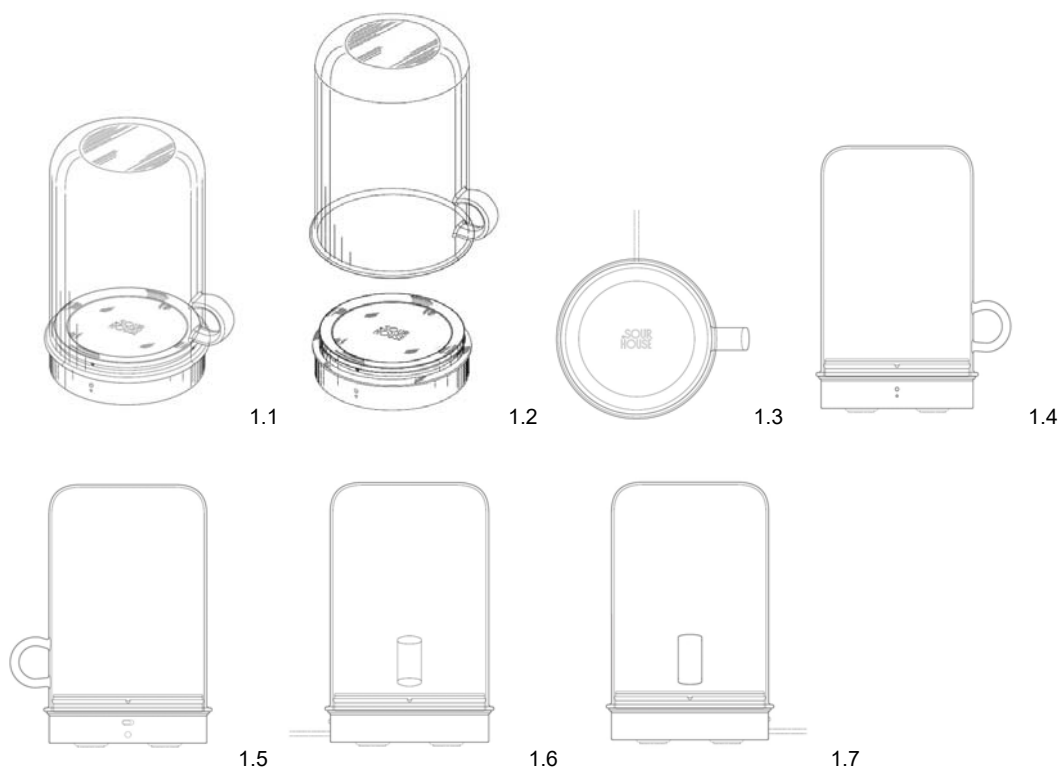

(11)	Reg.nr.:	DM/227979
(21)	Søkn.nr.:	20230420
(22)	Inngitt i WIPO:	2023.01.09
(15)	Registrert i WIPO:	2023.01.09
(24)	Løpedag:	2023.01.09
(43)	Allm. tilgj.:	2024.01.12
(15)	Besluttet gjeldende NO:	2024.01.16
(45)	Kunngjort NO:	2024.02.05
(18)	Reg. gjelder til:	2028.01.09
(73)	Innehaver:	Fotograf Morten Wanvik AS, Midtunhaugen 10, 5224 NESTTUN, Norge

Design 1

(54)	Produkt:	Travelling bag for car
(51)	Klasse:	03-01
(72)	Designer:	Morten Wanvik, Midtunhaugen 10, 5224 NESTTUN
(55)	Designavbildninger:	



1.1



1.2



1.3



1.4



1.5



1.6

(11)	Reg.nr.:	DM/228993
(21)	Søkn.nr.:	20230631
(22)	Inngitt i WIPO:	2022.12.29
(15)	Registrert i WIPO:	2022.12.29
(24)	Løpedag:	2022.12.29
(43)	Allm. tilgj.:	2023.12.29
(15)	Besluttet gjeldende NO:	2024.01.18
(45)	Kunngjort NO:	2024.02.05
(18)	Reg. gjelder til:	2027.12.29
(73)	Innehaver:	Santa Maria AB, Neongatan 5, 43153 MÖLNDAL, Sverige
(50)	Anmerkninger:	Registreringen gjelder samregistrering

Design 1

(54)	Produkt:	Packaging for foodstuffs
(51)	Klasse:	09-03
(72)	Designer:	Jonathan Rogers, Brandon Consultants Ltd. 12 Royal Field Close Hullavington, SN146DY WILTSHIRE, Storbritannia Sam Hadley, Sam Hadley Art Bayfields, Garrettstown, Kinsale, P17A097 CORK, Irland Simon Thomas, Simon Thomas Studios 7 Osborne Road, BA13JR BATH, Storbritannia
(55)	Designavbildninger:	



1.1

Design 2

- (54) **Produkt:** Packaging for foodstuffs
(51) **Klasse:** 09-03
(72) **Designer:** Jonathan Rogers, Brandon Consultants Ltd. 12 Royal Field Close Hullavington, SN146DY WILTSHIRE, Storbritannia
Sam Hadley, Sam Hadley Art Bayfields, Garrettstown, Kinsale, P17A097 CORK, Irland
Simon Thomas, Simon Thomas Studios 7 Osborne Road, BA13JR BATH, Storbritannia
- (55) **Designavbildninger:**



2.1

Design 3

- (54) **Produkt:** Packaging for foodstuffs
(51) **Klasse:** 09-03
(72) **Designer:** Jonathan Rogers, Brandon Consultants Ltd. 12 Royal Field Close Hullavington, SN146DY WILTSHIRE, Storbritannia
Sam Hadley, Sam Hadley Art Bayfields, Garrettstown, Kinsale, P17A097 CORK, Irland
Simon Thomas, Simon Thomas Studios 7 Osborne Road, BA13JR BATH, Storbritannia
- (55) **Designavbildninger:**



3.1

Design 4

- (54) **Produkt:** Packaging for foodstuffs
(51) **Klasse:** 09-03
(72) **Designer:** Jonathan Rogers, Brandon Consultants Ltd. 12 Royal Field Close Hullavington, SN146DY WILTSHIRE, Storbritannia
Sam Hadley, Sam Hadley Art Bayfields, Garrettstown, Kinsale, P17A097 CORK, Irland
Simon Thomas, Simon Thomas Studios 7 Osborne Road, BA13JR BATH, Storbritannia
- (55) **Designavbildninger:**



4.1

Design 5

- (54) **Produkt:** Packaging for foodstuffs
(51) **Klasse:** 09-03
(72) **Designer:** Jonathan Rogers, Brandon Consultants Ltd. 12 Royal Field Close Hullavington, SN146DY WILTSHIRE, Storbritannia
Sam Hadley, Sam Hadley Art Bayfields, Garrettstown, Kinsale, P17A097 CORK, Irland
Simon Thomas, Simon Thomas Studios 7 Osborne Road, BA13JR BATH, Storbritannia
- (55) **Designavbildninger:**



5.1

Design 6

- (54) **Produkt:** Packaging for foodstuffs
(51) **Klasse:** 09-03
(72) **Designer:** Jonathan Rogers, Brandon Consultants Ltd. 12 Royal Field Close Hullavington, SN146DY WILTSHIRE, Storbritannia
Sam Hadley, Sam Hadley Art Bayfields, Garrettstown, Kinsale, P17A097 CORK, Irland
Simon Thomas, Simon Thomas Studios 7 Osborne Road, BA13JR BATH, Storbritannia

(55) Designavbildninger:

6.1

Design 7

- (54) **Produkt:** Packaging for foodstuffs
(51) **Klasse:** 09-03
(72) **Designer:** Jonathan Rogers, Brandon Consultants Ltd. 12 Royal Field Close Hullavington, SN146DY WILTSHIRE, Storbritannia
Sam Hadley, Sam Hadley Art Bayfields, Garrettstown, Kinsale, P17A097 CORK, Irland
Simon Thomas, Simon Thomas Studios 7 Osborne Road, BA13JR BATH, Storbritannia

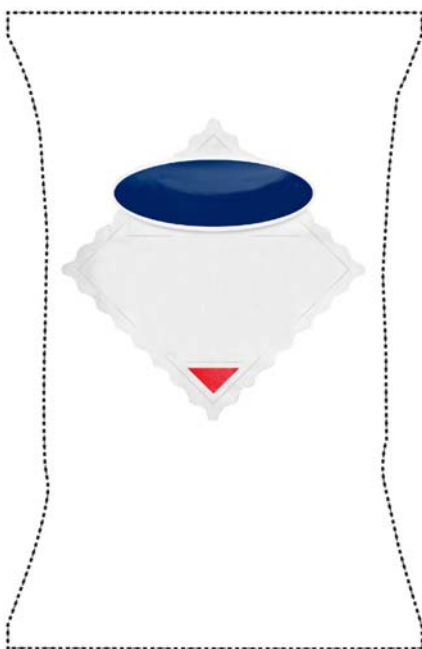
(55) Designavbildninger:

7.1

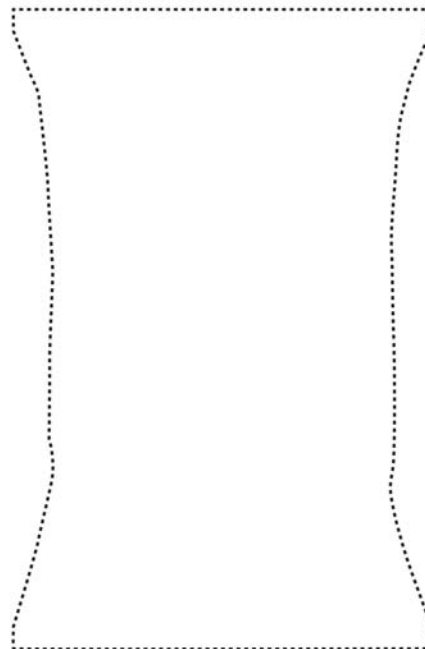

7.2

Design 8

- (54) **Produkt:** Packaging for foodstuffs
(51) **Klasse:** 09-03
(72) **Designer:** Jonathan Rogers, Brandon Consultants Ltd. 12 Royal Field Close Hullavington, SN146DY WILTSHIRE, Storbritannia
Sam Hadley, Sam Hadley Art Bayfields, Garrettstown, Kinsale, P17A097 CORK, Irland
Simon Thomas, Simon Thomas Studios 7 Osborne Road, BA13JR BATH, Storbritannia
- (55) **Designavbildninger:**

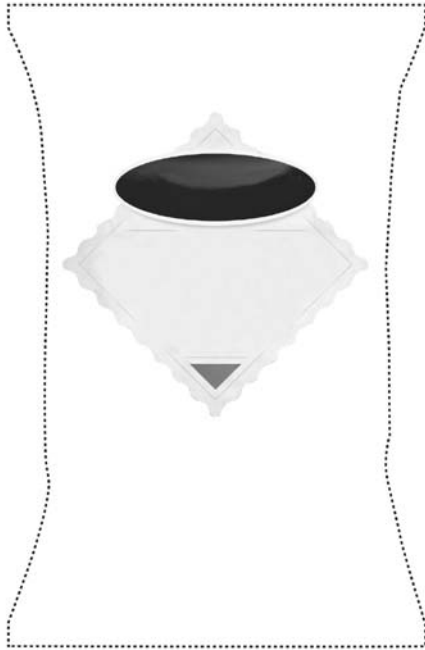

8.1

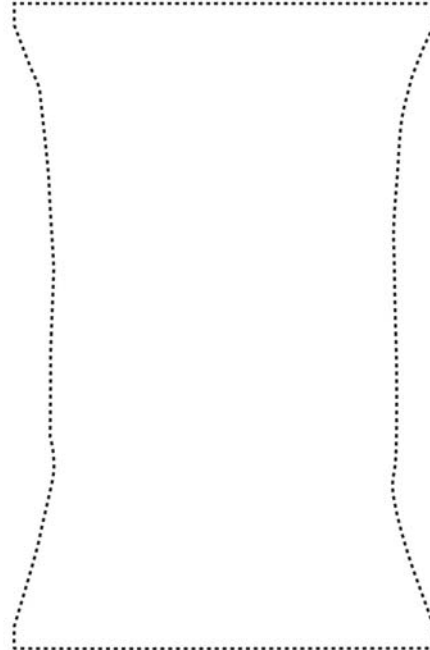

8.2

(11)	Reg.nr.:	DM/230612
(21)	Søkn.nr.:	20230925
(22)	Inngitt i WIPO:	2023.07.05
(15)	Registrert i WIPO:	2023.07.05
(24)	Løpedag:	2023.07.05
(43)	Allm. tilgj.:	2024.01.05
(15)	Besluttet gjeldende NO:	2024.01.10
(45)	Kunngjort NO:	2024.02.05
(18)	Reg. gjelder til:	2028.07.05
(73)	Innehaver:	Verisure Sàrl, Chemin Jean-Baptiste Vandelle 3/3 A, 1290 VERSOIX, Sveits
(50)	Anmerkninger:	Registreringen gjelder samregistrering

Design 1

(54)	Produkt:	Wrist watch
(51)	Klasse:	10-02
(72)	Designer:	Erik Ahlgren, Lågedammsgatan 13, 24231 HÖRBY, Sverige
(55)	Designavbildninger:	



1.1

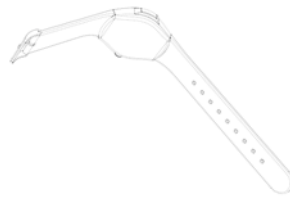

1.2



1.3



1.4



1.5



1.6



1.7



1.8

Design 2

(54)	Produkt:	Wrist watch
(51)	Klasse:	10-02
(72)	Designer:	Erik Ahlgren, Lågedammsgatan 13, 24231 HÖRBY, Sverige
(55)	Designavbildninger:	



2.1

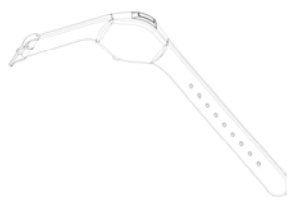

2.2



2.3



2.4



2.5



2.6



2.7



2.8

Design 3

- (54) **Produkt:** Wrist watch
- (51) **Klasse:** 10-02
- (72) **Designer:** Erik Ahlgren, Lågedammsgatan 13, 24231 HÖRBY, Sverige
- (55) **Designavbildninger:**



3.1



3.2



3.3



3.4



3.5



3.6



3.7



3.8

Design 4

(54) **Produkt:** Wrist watch
(51) **Klasse:** 10-02
(72) **Designer:** Erik Ahlgren, Lågedammsgatan 13, 24231 HÖRBY, Sverige
(55) **Designavbildninger:**



4.1



4.2



4.3



4.4



4.5



4.6



4.7



4.8

(11)	Reg.nr.:	DM/230618
(21)	Søkn.nr.:	20230927
(22)	Inngitt i WIPO:	2023.07.07
(15)	Registrert i WIPO:	2023.07.07
(24)	Løpedag:	2023.07.07
(43)	Allm. tilgj.:	2024.01.12
(15)	Besluttet gjeldende NO:	2024.01.16
(45)	Kunngjort NO:	2024.02.05
(18)	Reg. gjelder til:	2028.07.07
(73)	Innehaver:	Swatch AG (Swatch SA) (Swatch Ltd.), Nicolas G. Hayek Strasse 1, 2502 BIEL/BIENNE, Sveits

Design 1

(54)	Produkt:	Wristwatch
(51)	Klasse:	10-02
(72)	Designer:	Sarah Diante, 2 Serpentine Square, SK104HQ MACCLESFIELD, Storbritannia
(55)	Designavbildninger:	



1.1



1.2



1.3



1.4

(11)	Reg.nr.:	DM/230640
(21)	Søkn.nr.:	20230928
(22)	Inngitt i WIPO:	2023.07.06
(15)	Registrert i WIPO:	2023.07.06
(24)	Løpedag:	2023.07.06
(43)	Allm. tilgj.:	2024.01.12
(15)	Besluttet gjeldende NO:	2024.01.16
(45)	Kunngjort NO:	2024.02.05
(18)	Reg. gjelder til:	2028.07.06
(73)	Innehaver:	HARRY WINSTON SA, Chemin du Tourbillon 8, 1228 PLAN-LES-OUATES, Sveits

Design 1

(54)	Produkt:	Watch dial
(51)	Klasse:	10-07
(72)	Designer:	Silvia BOTTEGHI, c/o Harry Winston SA Chemin du Tourbillon 8, 1228 PLAN-LES-OUATES, Sveits
(55)	Designavbildninger:	

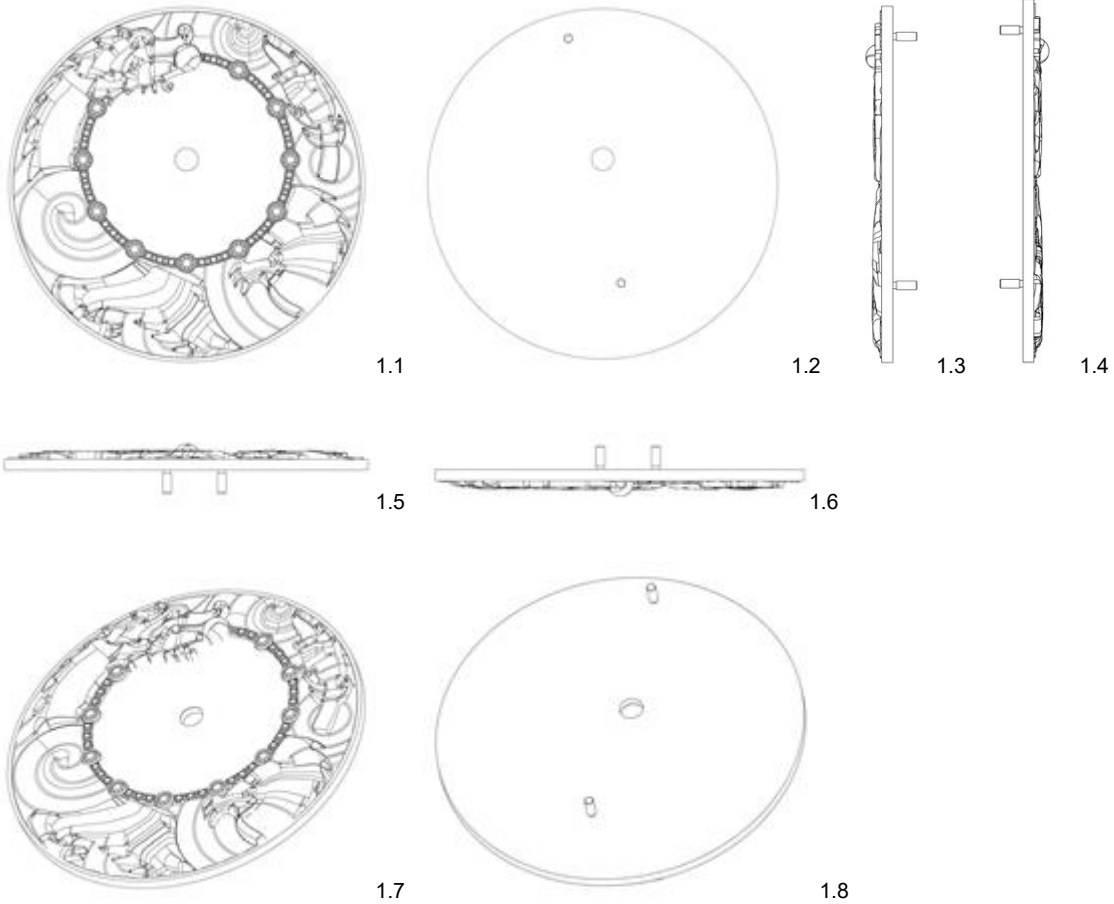

(11)	Reg.nr.:	DM/230654
(21)	Søkn.nr.:	20230929
(22)	Inngitt i WIPO:	2023.07.07
(15)	Registrert i WIPO:	2023.07.07
(24)	Løpedag:	2023.07.07
(43)	Allm. tilgj.:	2024.01.12
(15)	Besluttet gjeldende NO:	2024.01.16
(45)	Kunngjort NO:	2024.02.05
(18)	Reg. gjelder til:	2028.07.07
(73)	Innehaver:	OMEGA SA (OMEGA AG) (OMEGA LTD.), Jakob-Stämpfli-Strasse 96, 2502 BIEL/BIENNE, Sveits

Design 1

(54)	Produkt:	Watch dial
(51)	Klasse:	10-07
(72)	Designer:	Gregory Kissling, c/o Omega SA (Omega AG) (Omega Ltd), Jakob-Stämpfli-Strasse 96, 2502 BIEL/BIENNE, Sveits
(55)	Designavbildninger:	

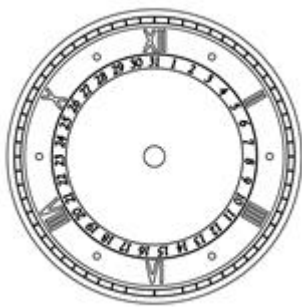

1.1

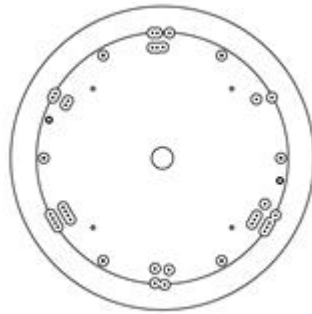

1.2



1.3



1.4



1.5



1.6



1.7

(11)	Reg.nr.:	DM/230658
(21)	Søkn.nr.:	20230930
(22)	Inngitt i WIPO:	2023.07.07
(15)	Registrert i WIPO:	2023.07.07
(24)	Løpedag:	2023.07.07
(43)	Allm. tilgj.:	2024.01.12
(15)	Besluttet gjeldende NO:	2024.01.16
(45)	Kunngjort NO:	2024.02.05
(18)	Reg. gjelder til:	2028.07.07
(73)	Innehaver:	HARRY WINSTON SA, Chemin du Tourbillon 8, 1228 PLAN-LES-OUATES, Sveits
(50)	Anmerkninger:	Registreringen gjelder samregistrering

Design 1

(54)	Produkt:	Finger ring
(51)	Klasse:	11-01
(72)	Designer:	Rie YATSUGI-KANG, c/o Harry Winston Inc. 718 Fifth Avenue, NY10019 NEW YORK, USA
(55)	Designavbildninger:	



1.1



1.2



1.3



1.4



1.5



1.6



1.7



1.8

Design 2

(54) **Produkt:** Necklace with pendant
 (51) **Klasse:** 11-01
 (72) **Designer:** Tobias WUEST, c/o Harry Winston Inc., 718 Fifth Avenue, NY10019 NEW YORK, USA
 (55) **Designavbildninger:**



2.1

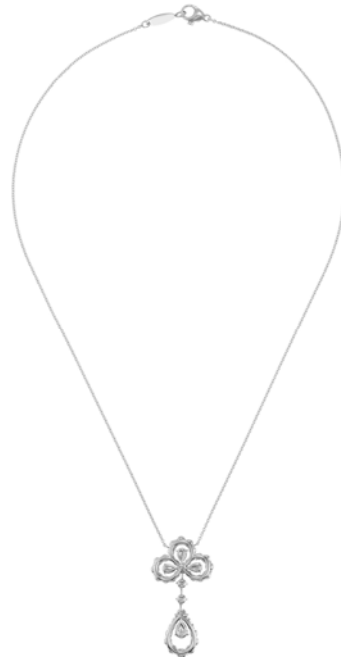

2.2



2.3



2.4



2.5



2.6



2.7



2.8

(11)	Reg.nr.:	DM/230836
(21)	Søkn.nr.:	20230934
(22)	Inngitt i WIPO:	2023.08.02
(15)	Registrert i WIPO:	2023.08.02
(24)	Løpedag:	2023.08.02
(43)	Allm. tilgj.:	2024.01.05
(15)	Besluttet gjeldende NO:	2024.01.10
(45)	Kunngjort NO:	2024.02.05
(18)	Reg. gjelder til:	2028.08.02
(73)	Innehaver:	HERMES SELLIER (SOCIÉTÉ PAR ACTIONS SIMPLIFIÉE), 24 rue du Faubourg Saint-Honoré, 75008 PARIS, Frankrike

Design 1

(54)	Produkt:	Bracelet
(51)	Klasse:	11-01
(72)	Designer:	Philippe Mouquet, 19, boulevard Delessert, 75016 PARIS, Frankrike
(55)	Designavbildninger:	



1.1



1.2



1.3



1.4



1.5



1.6



1.7



1.8

(11)	Reg.nr.:	DM/232259
(21)	Søkn.nr.:	20231200
(22)	Inngitt i WIPO:	2022.12.27
(15)	Registrert i WIPO:	2022.12.27
(24)	Løpedag:	2022.12.27
(43)	Allm. tilgj.:	2023.12.29
(15)	Besluttet gjeldende NO:	2024.01.18
(45)	Kunngjort NO:	2024.02.05
(18)	Reg. gjelder til:	2027.12.27
(73)	Innehaver:	Charge Amps AB, Frösundaleden 2B, 8tr, 16975 SOLNA, Sverige
(50)	Anmerkninger:	Registreringen gjelder samregistrering

Design 1

(54)	Produkt:	Charging station for electric vehicles
(51)	Klasse:	13-02
(72)	Designer:	Joachim Nordwall, Frösundaleden 2B, 8tr, 16975 SOLNA, Sverige
(30)	Prioritet:	2022.06.28, EM, 009071426, 1,2
(55)	Designavbildninger:	



1.1

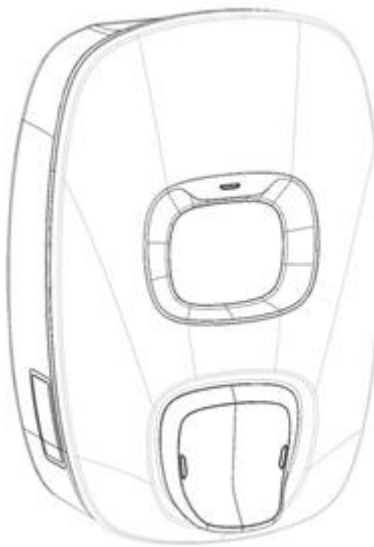

1.2

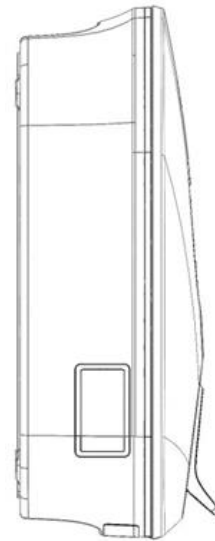

1.3

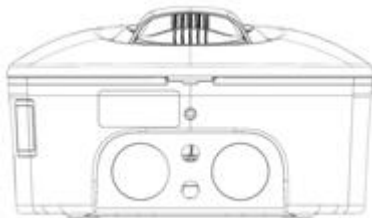

1.4



1.5

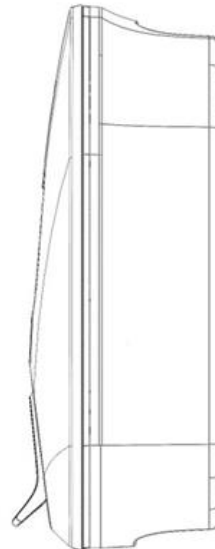

1.6



1.7

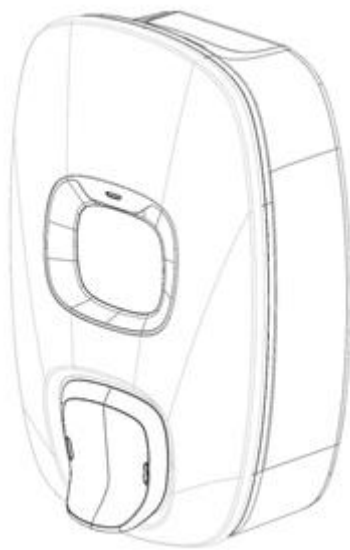

1.8

Design 2

(54) **Produkt:** Charging station for electric vehicles
(51) **Klasse:** 13-02
(72) **Designer:** Joachim Nordwall, Frösundaleden 2B, 8tr, 16975 SOLNA, Sverige
(30) **Prioritet:** 2022.06.28, EM, 009071426, 1,2
(55) **Designavbildninger:**



2.1



2.2



2.3



2.4



2.5



2.6



2.7



2.8

(11)	Reg.nr.:	DM/232309
(21)	Søkn.nr.:	20231206
(22)	Inngitt i WIPO:	2023.09.29
(15)	Registrert i WIPO:	2023.09.29
(24)	Løpedag:	2023.09.29
(43)	Allm. tilgj.:	2023.12.22
(15)	Besluttet gjeldende NO:	2024.01.08
(45)	Kunngjort NO:	2024.02.05
(18)	Reg. gjelder til:	2028.09.29
(73)	Innehaver:	VKR Holding A/S, Breeltevej 18, 2970 HØRS HOLM, Danmark
(50)	Anmerkninger:	Registreringen gjelder samregistrering

Design 1

(54)	Produkt:	Window (part of-)
(51)	Klasse:	25-02
(72)	Designer:	Kristian Strand Grønbæk, Ståhøj 4, 8751 GEDVED, Danmark
(30)	Prioritet:	2023.03.30, EM, 015016378, 1
(55)	Designavbildninger:	

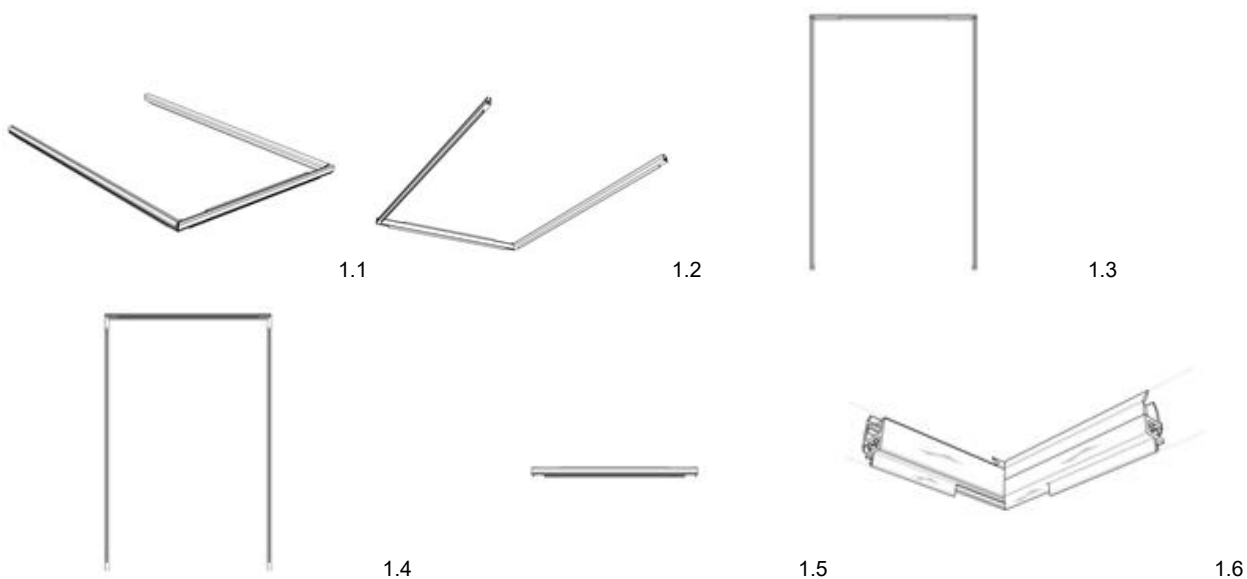
**Design 2**

(54)	Produkt:	Window (part of-)
(51)	Klasse:	25-02
(72)	Designer:	Kristian Strand Grønbæk, Ståhøj 4, 8751 GEDVED, Danmark
(55)	Designavbildninger:	

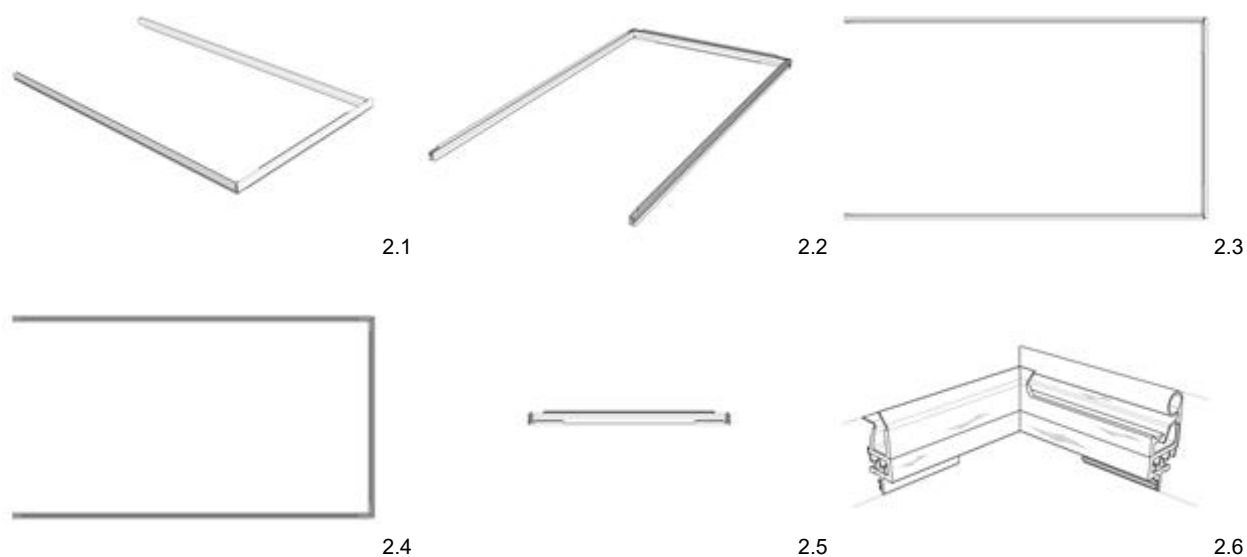

(11)	Reg.nr.:	DM/232875
(21)	Søkn.nr.:	20231305
(22)	Inngitt i WIPO:	2023.07.07
(15)	Registrert i WIPO:	2023.07.07
(24)	Løpedag:	2023.07.07
(43)	Allm. tilgj.:	2024.01.12
(15)	Besluttet gjeldende NO:	2024.01.17
(45)	Kunngjort NO:	2024.02.05
(18)	Reg. gjelder til:	2028.07.07
(73)	Innehaver:	GESKE GmbH, Leipziger Platz 18, 10117 BERLIN, Tyskland
(50)	Anmerkninger:	Registreringen gjelder samregistrering

Design 1

(54)	Produkt:	Anti-wrinkle appliance
(51)	Klasse:	28-03
(55)	Designavbildninger:	

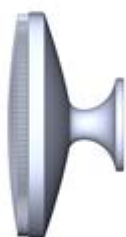

1.1



1.2



1.3



1.4



1.5



1.6



1.7



1.8



1.9



1.10



1.11



1.12

Design 2

(54)

Produkt:

Anti-wrinkle appliance

(51)

Klasse:

28-03

(55)

Designavbildninger:



2.1



2.2



2.3



2.4



2.5



2.6



2.7



2.8



2.9



2.10



2.11



2.12

Design 3

(54) **Produkt:** Anti-wrinkle appliance
 (51) **Klasse:** 28-03
 (55) **Designavbildninger:**



3.1



3.2



3.3



3.4



3.5



3.6



3.7



3.8



3.9



3.10



3.11



3.12

Design 4

(54) **Produkt:** Anti-wrinkle appliance
 (51) **Klasse:** 28-03
 (55) **Designavbildninger:**



4.1



4.2



4.3



4.4



4.5



4.6



4.7



4.8



4.9



4.10



4.11



4.12

Design 5

(54)

Produkt:

Hair-removing appliance

(51)

Klasse:

28-03

(55)

Designavbildninger:



5.1



5.2



5.3



5.4



5.5



5.6



5.7



5.8



5.9



5.10



5.11



5.12

Design 6

(54)

Produkt:

Hair-removing appliance

(51)

Klasse:

28-03

(55)

Designavbildninger:



6.1



6.2



6.3



6.4



6.5



6.6



6.7



6.8



6.9



6.10



6.11



6.12

Design 7

(54)

Produkt:

Hair-removing appliance

(51)

Klasse:

28-03

(55)

Designavbildninger:



7.1



7.2



7.3



7.4



7.5



7.6



7.7



7.8



7.9



7.10



7.11



7.12

Design 8

(54)

Produkt:

Hair-removing appliance

(51)

Klasse:

28-03

(55)

Designavbildninger:



8.1



8.2



8.3



8.4



8.5



8.6



8.7



8.8



8.9



8.10



8.11



8.12

Design 9

(54)

Produkt:

Hair-removing appliance

(51)

Klasse:

28-03

(55)

Designavbildninger:



9.1



9.2



9.3



9.4



9.5



9.6



9.7



9.8



9.9



9.10



9.11



9.12

Design 10

(54)

Produkt:

Hair-removing appliance

(51)

Klasse:

28-03

(55)

Designavbildninger:



10.1



10.2



10.3



10.4



10.5



10.6



10.7



10.8



10.9



10.10



10.11



10.12

Design 11

(54) **Produkt:** Hair-removing appliance
 (51) **Klasse:** 28-03
 (55) **Designavbildninger:**



11.1



11.2



11.3



11.4



11.5



11.6



11.7



11.8



11.9



11.10



11.11



11.12

Design 12

(54) **Produkt:** Hair-removing appliance
(51) **Klasse:** 28-03
(55) **Designavbildninger:**



12.1



12.2



12.3



12.4



12.5



12.6



12.7



12.8



12.9



12.10



12.11



12.12

Design 13

(54) **Produkt:** Hair-removing appliance
 (51) **Klasse:** 28-03
 (55) **Designavbildninger:**



13.1



13.2



13.3



13.4



13.5



13.6



13.7



13.8



13.9



13.10



13.11



13.12

Design 14

(54) **Produkt:** Hair-removing appliance
 (51) **Klasse:** 28-03
 (55) **Designavbildninger:**



14.1



14.2



14.3



14.4



14.5



14.6



14.7



14.8



14.9



14.10



14.11



14.12

Design 15

(54)

Produkt:

Hair-removing appliance

(51)

Klasse:

28-03

(55)

Designavbildninger:



15.1



15.2



15.3



15.4



15.5



15.6



15.7



15.8



15.9



15.10



15.11



15.12

Design 16

(54) **Produkt:** Hair-removing appliance
 (51) **Klasse:** 28-03
 (55) **Designavbildninger:**



16.1



16.2



16.3



16.4



16.5



16.6



16.7



16.8



16.9



16.10



16.11



16.12

Design 17

(54) **Produkt:** Hair-removing appliance
(51) **Klasse:** 28-03
(55) **Designavbildninger:**



17.1



17.2



17.3



17.4



17.5



17.6



17.7



17.8



17.9



17.10



17.11



17.12

Design 18

(54) **Produkt:** Hair-removing appliance
 (51) **Klasse:** 28-03
 (55) **Designavbildninger:**



18.1



18.2



18.3



18.4



18.5



18.6



18.7



18.8



18.9



18.10



18.11



18.12

Design 19

(54) **Produkt:** Hair-removing appliance
 (51) **Klasse:** 28-03
 (55) **Designavbildninger:**



19.1



19.2



19.3



19.4



19.5



19.6



19.7



19.8



19.9



19.10



19.11



19.12

Design 20

(54) **Produkt:** Anti-wrinkle appliance
 (51) **Klasse:** 28-03
 (55) **Designavbildninger:**



20.1



20.2



20.3



20.4



20.5



20.6



20.7



20.8



20.9



20.10



20.11



20.12

Design 21

(54) **Produkt:** Anti-wrinkle appliance
 (51) **Klasse:** 28-03
 (55) **Designavbildninger:**



21.1



21.2



21.3



21.4



21.5



21.6



21.7



21.8



21.9



21.10



21.11



21.12

Design 22

(54) **Produkt:** Anti-wrinkle appliance
 (51) **Klasse:** 28-03
 (55) **Designavbildninger:**



22.1



22.2



22.3



22.4



22.5



22.6



22.7



22.8



22.9



22.10



22.11



22.12

Design 23

(54) **Produkt:** Anti-wrinkle appliance
(51) **Klasse:** 28-03
(55) **Designavbildninger:**



23.1



23.2



23.3



23.4



23.5



23.6



23.7



23.8



23.9



23.10



23.11



23.12

Design 24

(54) **Produkt:** Anti-wrinkle appliance
 (51) **Klasse:** 28-03
 (55) **Designavbildninger:**



24.1



24.2



24.3



24.4



24.5



24.6



24.7



24.8



24.9



24.10



24.11



24.12

Design 25

(54) **Produkt:** Anti-wrinkle appliance
 (51) **Klasse:** 28-03
 (55) **Designavbildninger:**



25.1



25.2



25.3



25.4



25.5



25.6



25.7



25.8



25.9



25.10



25.11



25.12

Design 26

(54) **Produkt:** Eye mask [for cosmetic purposes]
 (51) **Klasse:** 28-03
 (55) **Designavbildninger:**



26.1



26.2



26.3



26.4



26.5



26.6



26.7



26.8



26.9



26.10



26.11



26.12

Design 27

(54) **Produkt:** Eye mask [for cosmetic purposes]
 (51) **Klasse:** 28-03
 (55) **Designavbildninger:**



27.1



27.2



27.3



27.4



27.5



27.6



27.7



27.8



27.9



27.10



27.11



27.12

Design 28

(54) **Produkt:** Eye mask [for cosmetic purposes]
 (51) **Klasse:** 28-03
 (55) **Designavbildninger:**



28.1



28.2



28.3



28.4



28.5



28.6



28.7



28.8



28.9



28.10



28.11



28.12

Design 29

(54) **Produkt:** Anti-wrinkle appliance
 (51) **Klasse:** 28-03
 (55) **Designavbildninger:**



29.1



29.2



29.3



29.4



29.5



29.6



29.7



29.8



29.9



29.10



29.11



29.12

Design 30

(54)

Produkt:

Anti-wrinkle appliance

(51)

Klasse:

28-03

(55)

Designavbildninger:



30.1



30.2



30.3



30.4



30.5



30.6



30.7



30.8



30.9



30.10



30.11



30.12

Design 31

(54) **Produkt:** Anti-wrinkle appliance
(51) **Klasse:** 28-03
(55) **Designavbildninger:**



31.1



31.2



31.3



31.4



31.5



31.6



31.7



31.8



31.9



31.10



31.11



31.12

Design 32

(54) **Produkt:**

Anti-wrinkle appliance

(51) **Klasse:**

28-03

(55) **Designavbildninger:**



32.1



32.2



32.3



32.4



32.5



32.6



32.7



32.8



32.9



32.10



32.11



32.12

Design 33

(54) **Produkt:** Anti-wrinkle appliance
 (51) **Klasse:** 28-03
 (55) **Designavbildninger:**



33.1



33.2



33.3



33.4



33.5



33.6



33.7



33.8



33.9



33.10



33.11



33.12

Design 34

(54) **Produkt:** Anti-wrinkle appliance
(51) **Klasse:** 28-03
(55) **Designavbildninger:**



34.1



34.2



34.3



34.4



34.5



34.6



34.7



34.8



34.9



34.10



34.11



34.12

Design 35

(54) **Produkt:** Anti-wrinkle appliance
 (51) **Klasse:** 28-03
 (55) **Designavbildninger:**



35.1



35.2



35.3



35.4



35.5



35.6



35.7



35.8



35.9



35.10



35.11



35.12

Design 36

(54) **Produkt:** Anti-wrinkle appliance
 (51) **Klasse:** 28-03
 (55) **Designavbildninger:**



36.1



36.2



36.3



36.4



36.5



36.6



36.7



36.8



36.9



36.10



36.11



36.12

Design 37

(54) **Produkt:** Anti-wrinkle appliance
(51) **Klasse:** 28-03
(55) **Designavbildninger:**



37.1



37.2



37.3



37.4



37.5



37.6



37.7



37.8



37.9



37.10



37.11



37.12

Design 38

(54) **Produkt:** Anti-wrinkle appliance
 (51) **Klasse:** 28-03
 (55) **Designavbildninger:**



38.1



38.2



38.3



38.4



38.5



38.6



38.7



38.8



38.9



38.10



38.11



38.12

Design 39

(54)

Produkt:

Anti-wrinkle appliance

(51)

Klasse:

28-03

(55)

Designavbildninger:



39.1



39.2



39.3



39.4



39.5



39.6



39.7



39.8



39.9



39.10



39.11



39.12

Design 40

(54) **Produkt:**

(51) **Klasse:**

(55) **Designavbildninger:**

Part of anti-wrinkle appliance
28-03



40.1



40.2



40.3



40.4



40.5



40.6



40.7



40.8



40.9



40.10



40.11



40.12

Design 41

(54) **Produkt:** Anti-wrinkle appliance
(51) **Klasse:** 28-03
(55) **Designavbildninger:**



41.1



41.2



41.3



41.4



41.5



41.6



41.7



41.8



41.9



41.10



41.11



41.12

Design 42

(54) **Produkt:**

Part of anti-wrinkle appliance

(51) **Klasse:**

28-03

(55) **Designavbildninger:**



42.1



42.2



42.3



42.4



42.5



42.6



42.7



42.8



42.9



42.10



42.11



42.12

Design 43

(54) **Produkt:** Anti-wrinkle appliance
 (51) **Klasse:** 28-03
 (55) **Designavbildninger:**



43.1



43.2



43.3



43.4



43.5



43.6



43.7



43.8



43.9



43.10



43.11



43.12

Design 44

(54) **Produkt:**

Anti-wrinkle appliance

(51) **Klasse:**

28-03

(55) **Designavbildninger:**



44.1



44.2



44.3



44.4



44.5



44.6



44.7



44.8



44.9



44.10



44.11



44.12

Design 45

(54) **Produkt:** Part of anti-wrinkle appliance
 (51) **Klasse:** 28-03
 (55) **Designavbildninger:**



45.1



45.2



45.3



45.4



45.5



45.6



45.7



45.8



45.9



45.10



45.11



45.12

Design 46

(54)

Produkt:

Anti-wrinkle appliance

(51)

Klasse:

28-03

(55)

Designavbildninger:



46.1



46.2



46.3



46.4



46.5



46.6



46.7



46.8



46.9



46.10



46.11



46.12

Design 47

(54) **Produkt:**

Part of anti-wrinkle appliance

(51) **Klasse:**

28-03

(55) **Designavbildninger:**



47.1

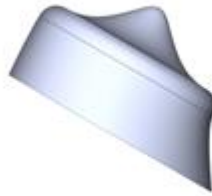

47.2



47.3



47.4



47.5



47.6



47.7



47.8



47.9



47.10



47.11



47.12

Design 48

(54) **Produkt:** Anti-wrinkle appliance
 (51) **Klasse:** 28-03
 (55) **Designavbildninger:**



48.1



48.2



48.3



48.4



48.5



48.6



48.7



48.8



48.9



48.10



48.11



48.12

Design 49

(54) **Produkt:** Part of anti-wrinkle appliance
(51) **Klasse:** 28-03
(55) **Designavbildninger:**



49.1



49.2



49.3



49.4



49.5



49.6



49.7



49.8



49.9



49.10



49.11



49.12

Design 50

(54)

Produkt:

Anti-wrinkle appliance

(51)

Klasse:

28-03

(55)

Designavbildninger:



50.1



50.2



50.3



50.4



50.5



50.6



50.7



50.8



50.9



50.10



50.11



50.12

Design 51

(54) **Produkt:**

Anti-wrinkle appliance

(51) **Klasse:**

28-03

(55) **Designavbildninger:**



51.1



51.2



51.3



51.4



51.5



51.6



51.7



51.8



51.9



51.10



51.11



51.12

Design 52

(54) **Produkt:** Part of anti-wrinkle appliance
 (51) **Klasse:** 28-03
 (55) **Designavbildninger:**



52.1



52.2



52.3



52.4



52.5



52.6



52.7



52.8



52.9



52.10



52.11



52.12

Design 53

(54) **Produkt:** Anti-wrinkle appliance
 (51) **Klasse:** 28-03
 (55) **Designavbildninger:**



53.1



53.2



53.3



53.4



53.5



53.6



53.7



53.8



53.9



53.10



53.11



53.12

Design 54

(54) **Produkt:** Part of anti-wrinkle appliance
(51) **Klasse:** 28-03
(55) **Designavbildninger:**



54.1



54.2



54.3



54.4



54.5



54.6



54.7



54.8



54.9



54.10



54.11



54.12

Design 55

(54) **Produkt:** Anti-wrinkle appliance
 (51) **Klasse:** 28-03
 (55) **Designavbildninger:**



55.1



55.2



55.3



55.4



55.5



55.6



55.7



55.8



55.9



55.10



55.11



55.12

Design 56

(54) **Produkt:**

Part of anti-wrinkle appliance

(51) **Klasse:**

28-03

(55) **Designavbildninger:**



56.1



56.2



56.3



56.4



56.5



56.6



56.7



56.8



56.9



56.10



56.11



56.12

Design 57

(54) **Produkt:** Anti-wrinkle appliance
(51) **Klasse:** 28-03
(55) **Designavbildninger:**



57.1



57.2



57.3



57.4



57.5



57.6



57.7



57.8



57.9



57.10



57.11



57.12

Design 58

(54) **Produkt:**

Part of anti-wrinkle appliance

(51) **Klasse:**

28-03

(55) **Designavbildninger:**



58.1



58.2



58.3



58.4



58.5



58.6



58.7



58.8



58.9



58.10



58.11



58.12

Design 59

(54) **Produkt:**

Hair-removing appliance

(51) **Klasse:**

28-03

(55) **Designavbildninger:**



59.1



59.2



59.3



59.4



59.5



59.6



59.7



59.8



59.9



59.10



59.11



59.12

Design 60

(54) **Produkt:** Hair-removing appliance
 (51) **Klasse:** 28-03
 (55) **Designavbildninger:**



60.1



60.2



60.3



60.4



60.5



60.6



60.7



60.8



60.9



60.10



60.11



60.12

Design 61

(54) **Produkt:** Hair-removing appliance
 (51) **Klasse:** 28-03
 (55) **Designavbildninger:**



61.1



61.2



61.3



61.4



61.5



61.6



61.7



61.8



61.9



61.10



61.11



61.12

(11)	Reg.nr.:	DM/233005
(21)	Søkn.nr.:	20231317
(22)	Inngitt i WIPO:	2023.09.29
(15)	Registrert i WIPO:	2023.09.29
(24)	Løpedag:	2023.09.29
(43)	Allm. tilgj.:	2023.12.22
(15)	Besluttet gjeldende NO:	2024.01.08
(45)	Kunngjort NO:	2024.02.05
(18)	Reg. gjelder til:	2028.09.29
(73)	Innehaver:	VKR Holding A/S, Breeltevej 18, 2970 HØRSHOLM, Danmark

Design 1

(54)	Produkt:	Window (part of-)
(51)	Klasse:	25-02
(72)	Designer:	Claus Holm, c/o VKR Holding A/S, 2970 HØRSHOLM, Danmark
(30)	Prioritet:	2023.03.30, EM, 015016377, 1
(55)	Designavbildninger:	



1.1



1.2



1.3



1.4



1.5



1.6



1.7



1.8



1.9

(11)	Reg.nr.:	DM/233737
(21)	Søkn.nr.:	20231338
(22)	Inngitt i WIPO:	2023.11.16
(15)	Registrert i WIPO:	2023.11.16
(24)	Løpedag:	2023.11.16
(43)	Allm. tilgj.:	2023.12.22
(15)	Besluttet gjeldende NO:	2024.01.08
(45)	Kunngjort NO:	2024.02.05
(18)	Reg. gjelder til:	2028.11.16
(73)	Innehaver:	Olga Troitskaya, Tarros 17-3, 08003 BARCELONA, CATALONIA, Spania

Design 1

(54)	Produkt:	Jumpsuit
(51)	Klasse:	02-02
(72)	Designer:	Olga Troitskaya, Tarros 17-3, 08003 BARCELONA, CATALONIA, Spania
(55)	Designavbildninger:	

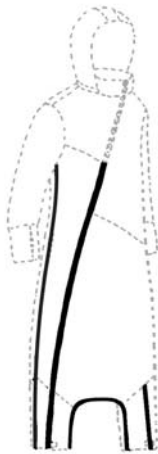

1.1

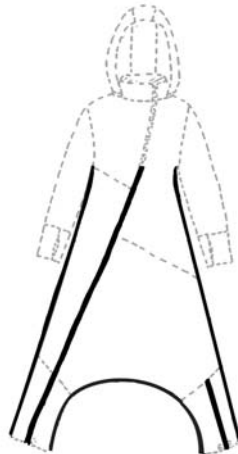

1.2

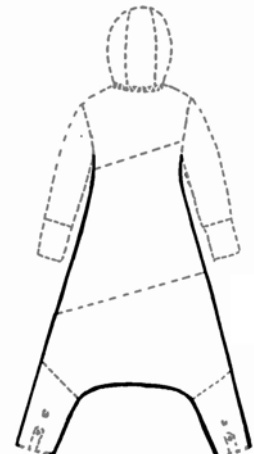

1.3



1.4



1.5

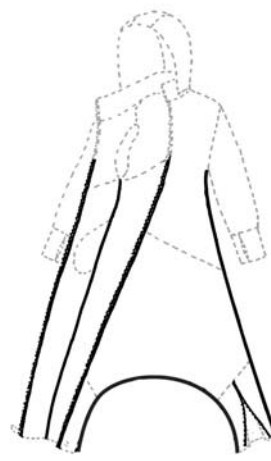

1.6

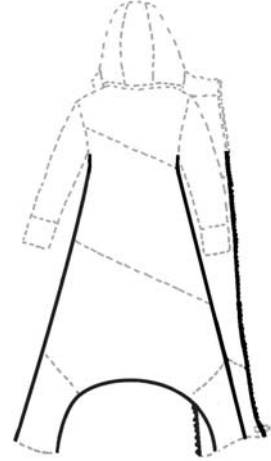

1.7

(11)	Reg.nr.:	DM/233789
(21)	Søkn.nr.:	20231339
(22)	Inngitt i WIPO:	2023.12.07
(15)	Registrert i WIPO:	2023.12.07
(24)	Løpedag:	2023.12.07
(43)	Allm. tilgj.:	2023.12.22
(15)	Besluttet gjeldende NO:	2024.01.08
(45)	Kunngjort NO:	2024.02.05
(18)	Reg. gjelder til:	2028.12.07
(73)	Innehaver:	L'OREAL, 14, rue Royale, 75008 PARIS, Frankrike

Design 1

(54)	Produkt:	Bottle for cosmetics [packaging]
(51)	Klasse:	09-01
(72)	Designer:	Stéphanie Halloumi, Campus Charles Zviak, Bât. RIO, 9 rue Pierre Dreyfus, 92110 CLICHY, Frankrike
(30)	Prioritet:	2023.06.14, EM, 015024425, 1
(55)	Designavbildninger:	

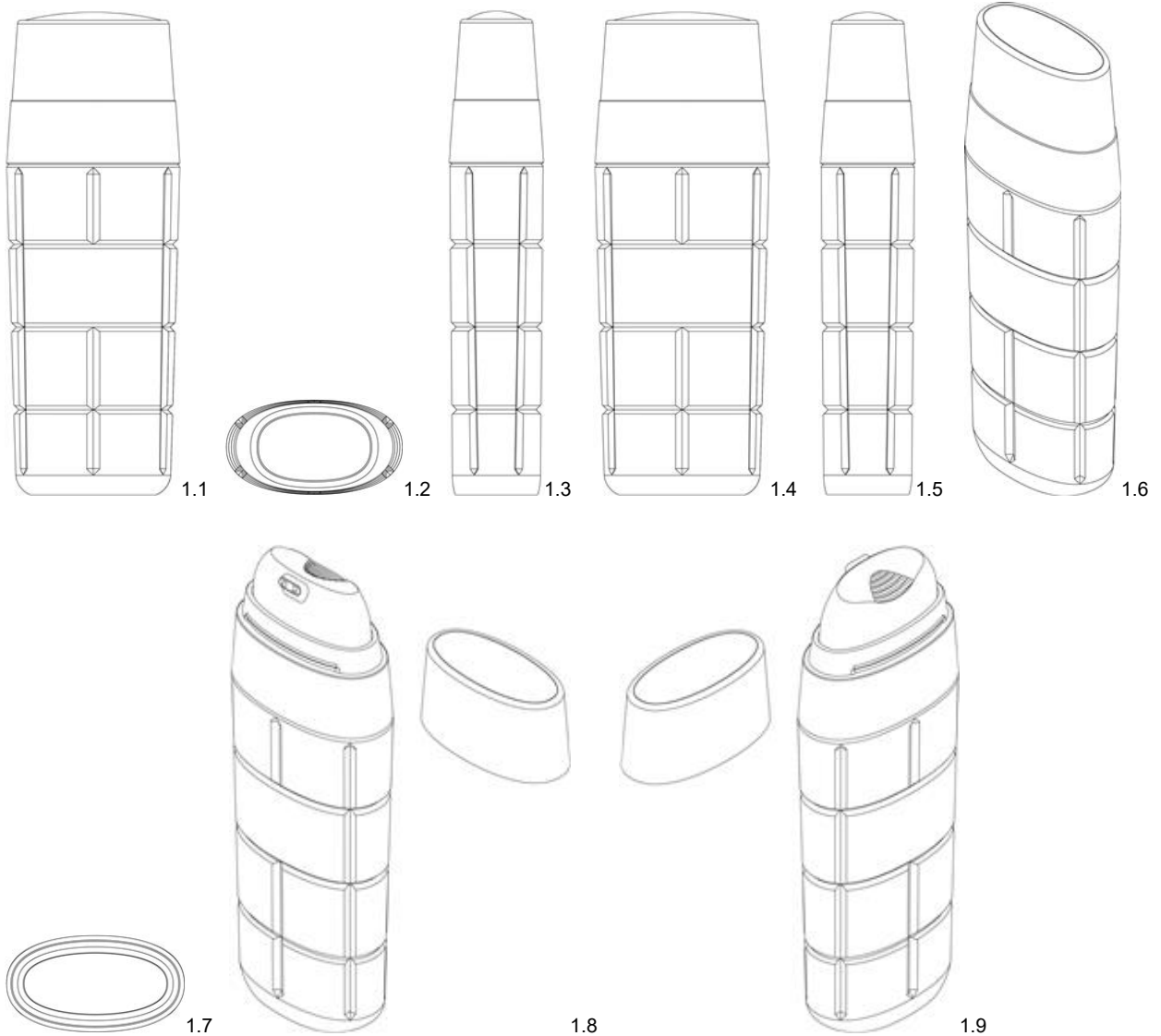

(11)	Reg.nr.:	DM/233852
(21)	Søkn.nr.:	20231340
(22)	Inngitt i WIPO:	2023.12.06
(15)	Registrert i WIPO:	2023.12.06
(24)	Løpedag:	2023.12.06
(43)	Allm. tilgj.:	2023.12.22
(15)	Besluttet gjeldende NO:	2024.01.08
(45)	Kunngjort NO:	2024.02.05
(18)	Reg. gjelder til:	2028.12.06
(73)	Innehaver:	By Klipklap ApS, Gåseagervej 14, 8250 EGÅ, Danmark

Design 1

(54)	Produkt:	Modular seat [furniture]
(51)	Klasse:	06-01
(72)	Designer:	Pia Lauritsen, Gåseagervej 14, 8250 EGÅ, Danmark
(55)	Designavbildninger:	



1.1



1.2



1.3



1.4



1.5

(11)	Reg.nr.:	DM/233854
(21)	Søkn.nr.:	20231341
(22)	Inngitt i WIPO:	2023.12.06
(15)	Registrert i WIPO:	2023.12.06
(24)	Løpedag:	2023.12.06
(43)	Allm. tilgj.:	2023.12.22
(15)	Besluttet gjeldende NO:	2024.01.08
(45)	Kunngjort NO:	2024.02.05
(18)	Reg. gjelder til:	2028.12.06
(73)	Innehaver:	By Kliplap ApS, Gåseagervej 14, 8250 EGÅ, Danmark

Design 1

(54)	Produkt:	Modular seat [furniture]
(51)	Klasse:	06-01
(72)	Designer:	Pia Lauritsen, Svinbovej 13, 8250 EGÅ, Danmark
(55)	Designavbildninger:	



1.1



1.2



1.3



1.4



1.5

(11)	Reg.nr.:	DM/233859
(21)	Søkn.nr.:	20231342
(22)	Inngitt i WIPO:	2023.11.17
(15)	Registrert i WIPO:	2023.11.17
(24)	Løpedag:	2023.11.17
(43)	Allm. tilgj.:	2023.12.22
(15)	Besluttet gjeldende NO:	2024.01.09
(45)	Kunngjort NO:	2024.02.05
(18)	Reg. gjelder til:	2028.11.17
(73)	Innehaver:	GNC (Shanghai) Food Products Technology Co., Ltd., Room 806, No. 369, Weining Road, Changning District, SHANGHAI, Kina

Design 1

(54)	Produkt:	Packaging box
(51)	Klasse:	09-03
(72)	Designer:	Jiajian Shu, Room 806, No. 369, Weining Road, Changning District, SHANGHAI, Kina
(30)	Prioritet:	2023.07.19, CN, 2023304523003, 1
(55)	Designavbildninger:	

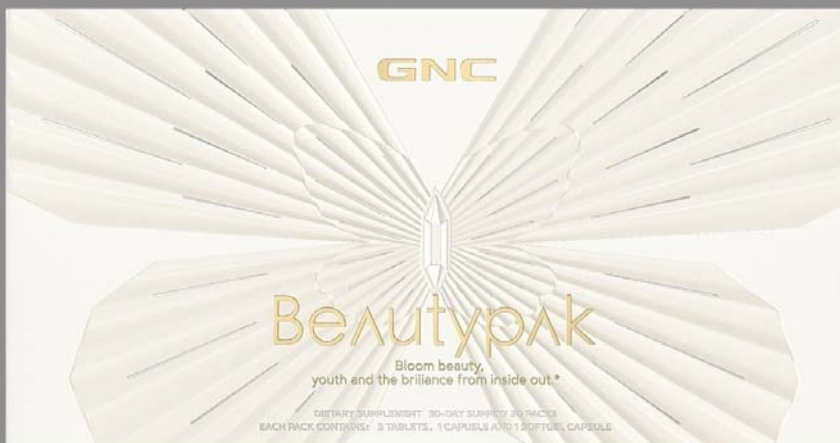



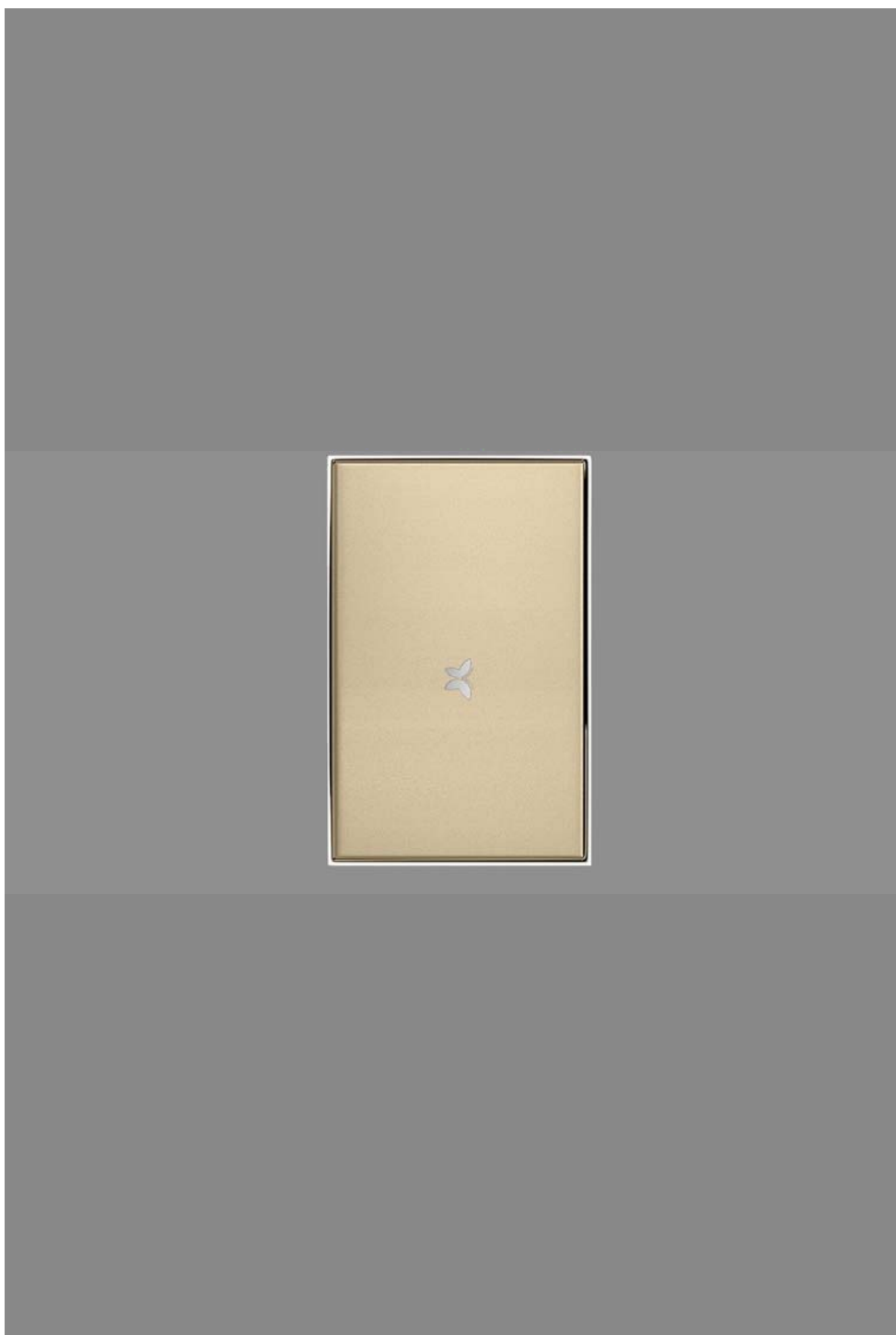

1.3

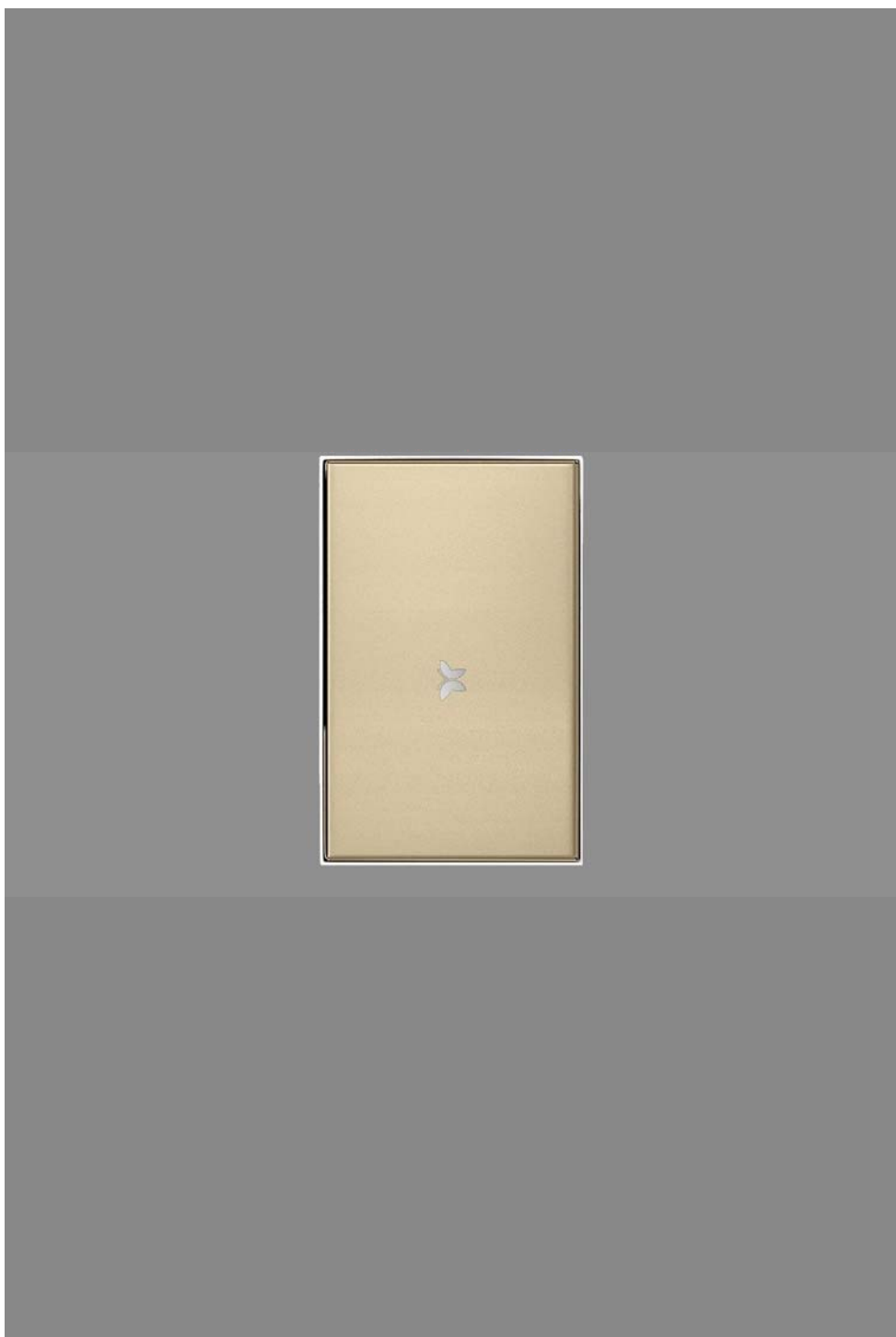

1.4



1.5

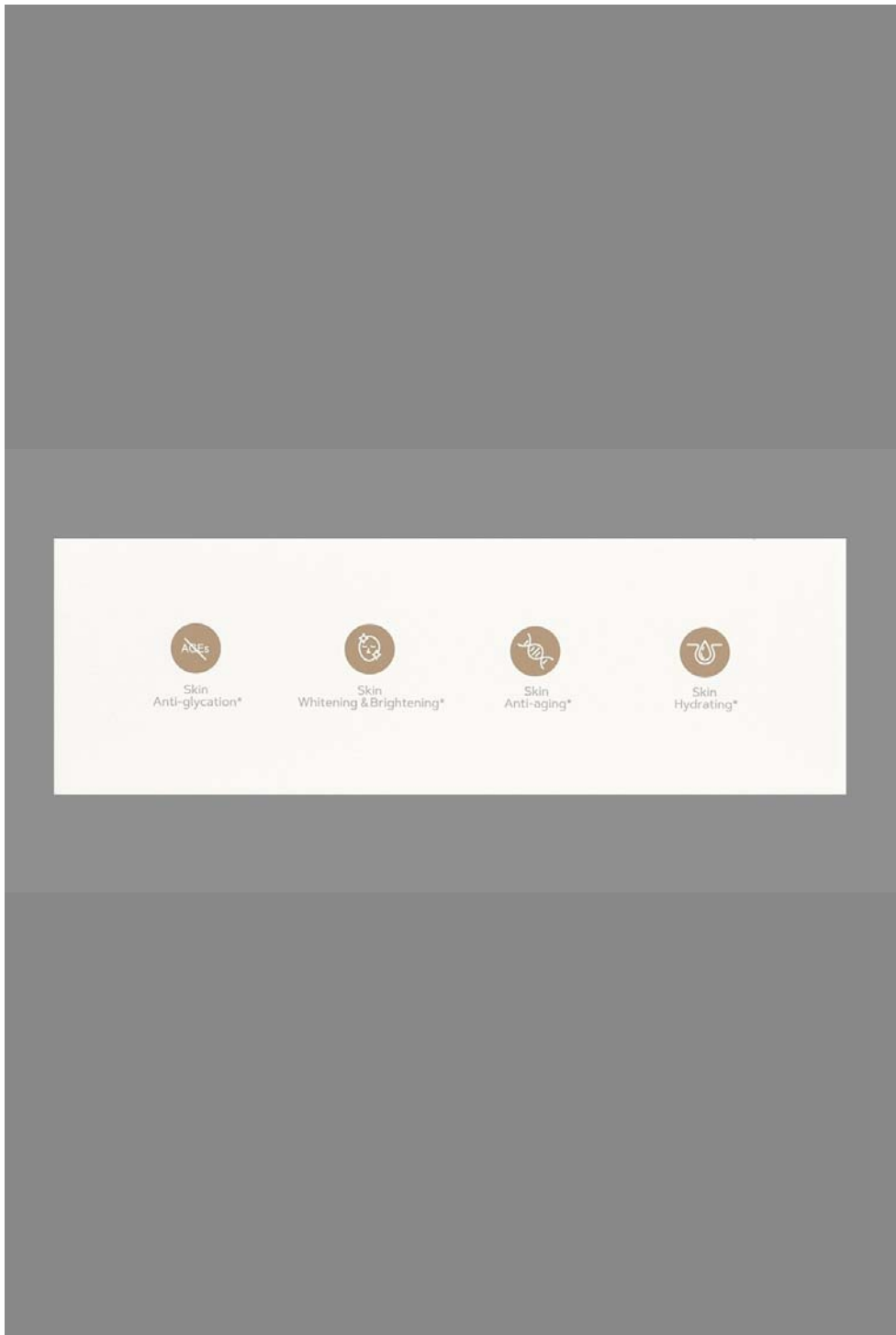

1.6



1.7

- (11) **Reg.nr.:** DM/233877
- (21) **Søkn.nr.:** 20231343
- (22) **Inngitt i WIPO:** 2023.10.10
- (15) **Registrert i WIPO:** 2023.10.10
- (24) **Løpedag:** 2023.10.10
- (43) **Allm. tilgj.:** 2023.12.22
- (15) **Besluttet gjeldende NO:** 2024.01.08
- (45) **Kunngjort NO:** 2024.02.05
- (18) **Reg. gjelder til:** 2028.10.10
- (73) **Innehaver:** puzzleYOU GmbH, Auf der Haide 2, 92665 ALTENSTADT A. D. WALDNAAB, Tyskland
- (50) **Anmerkninger:** Registreringen gjelder samregistrering

Design 1

- (54) **Produkt:** Packaging box
- (51) **Klasse:** 09-03
- (72) **Designert:** Norbert Weig, Auf der Haide 2, 92665 ALTENSTADT A. D. WALDNAAB, Tyskland
- (55) **Designavbildninger:**

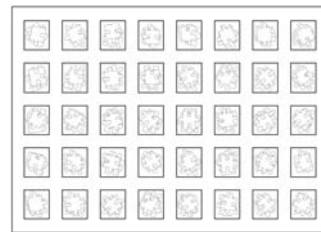
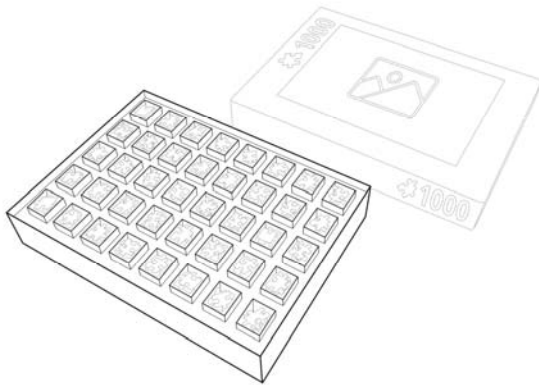

1.1

1.2



1.3

1.4

1.5



1.6

1.7

Design 2

- (54) **Produkt:** Packaging box
- (51) **Klasse:** 09-03
- (72) **Designer:** Norbert Weig, Auf der Haide 2, 92665 ALTENSTADT A. D. WALDNAAB, Tyskland
- (55) **Designavbildninger:**

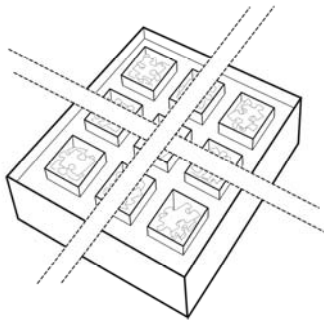

2.1

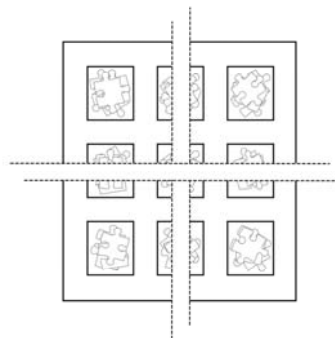

2.2

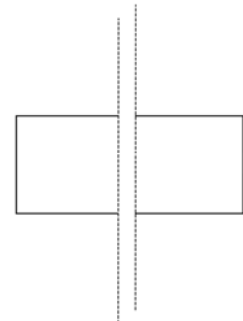

2.3

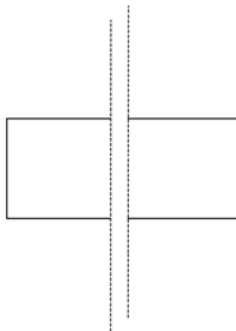

2.4

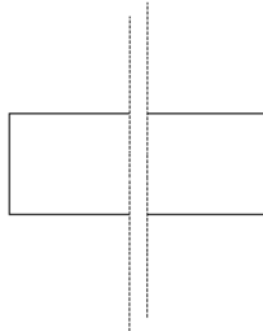

2.5

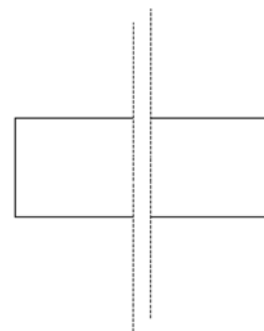

2.6

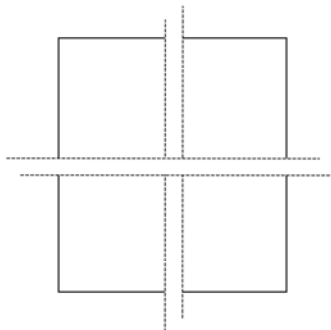

2.7

Design 3

- (54) **Produkt:** Packaging box
- (51) **Klasse:** 09-03
- (72) **Designer:** Norbert Weig, Auf der Haide 2, 92665 ALTENSTADT A. D. WALDNAAB, Tyskland
- (55) **Designavbildninger:**

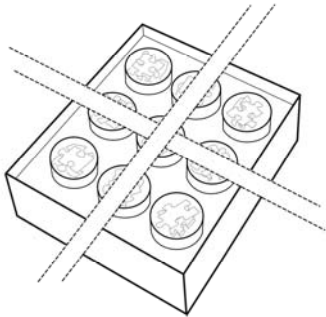

3.1

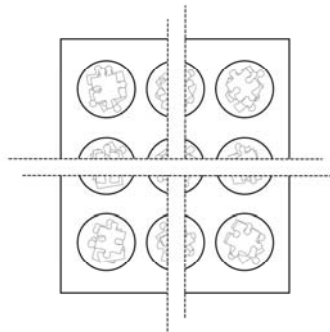

3.2

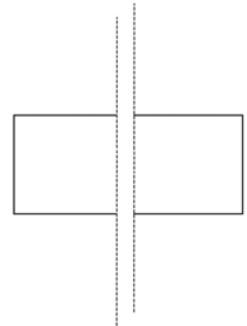

3.3

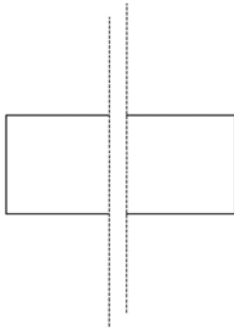

3.4

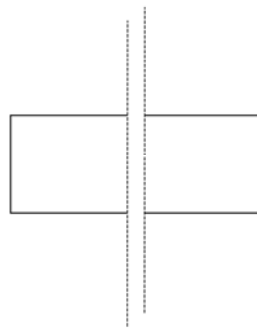

3.5

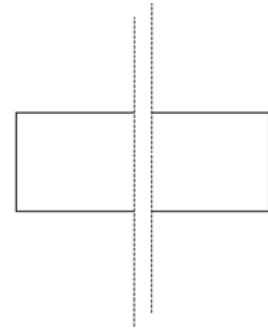

3.6

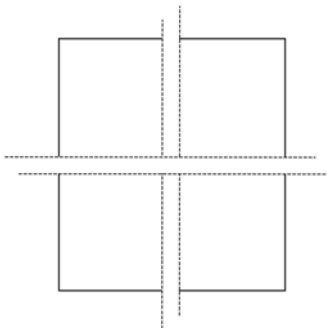

3.7

(11)	Reg.nr.:	DM/233887
(21)	Søkn.nr.:	20231344
(22)	Inngitt i WIPO:	2023.10.13
(15)	Registrert i WIPO:	2023.10.13
(24)	Løpedag:	2023.10.13
(43)	Allm. tilgj.:	2023.12.22
(15)	Besluttet gjeldende NO:	2024.01.08
(45)	Kunngjort NO:	2024.02.05
(18)	Reg. gjelder til:	2028.10.13
(73)	Innehaver:	LUMINA ITALIA S.R.L., Via Casorezzo, 63, 20010 ARLUNO, Italia

Design 1

(54)	Produkt:	Downlight
(51)	Klasse:	26-05
(72)	Designer:	Riccardo MARCUZZO, c/o LUMINA ITALIA S.R.L., Via Casorezzo 63, 20010 ARLUNO, Italia
(30)	Prioritet:	2023.04.18, EM, 015018483 , 1
(55)	Designavbildninger:	



1.1



1.2



1.3



1.4



1.5



1.6



1.7



1.8

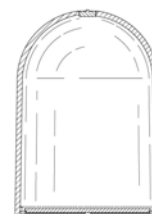

1.9

(11)	Reg.nr.:	DM/234114
(21)	Søkn.nr.:	20240006
(22)	Inngitt i WIPO:	2023.09.21
(15)	Registrert i WIPO:	2023.09.21
(24)	Løpedag:	2023.09.21
(43)	Allm. tilgj.:	2024.01.05
(15)	Besluttet gjeldende NO:	2024.01.11
(45)	Kunngjort NO:	2024.02.05
(18)	Reg. gjelder til:	2028.09.21
(73)	Innehaver:	Gry & Sif ApS, Søgade 16, 2, 4100 RINGSTED, Danmark
(50)	Anmerkninger:	Registreringen gjelder samregistrering

Design 1

(54)	Produkt:	Figurine
(51)	Klasse:	11-02
(72)	Designer:	Gry Højgaard Staunstrup, Jordmoderstien 21, 4100 RINGSTED, Danmark
(55)	Designavbildninger:	

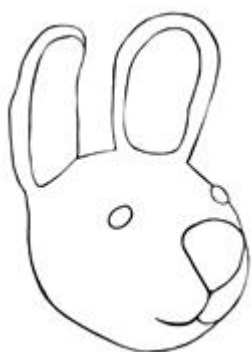

1.1



1.2

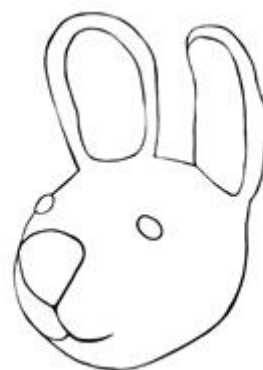

1.3

Design 2

(54)	Produkt:	Figurine
(51)	Klasse:	11-02
(72)	Designer:	Gry Højgaard Staunstrup, Jordmoderstien 21, 4100 RINGSTED, Danmark
(55)	Designavbildninger:	



2.1



2.2

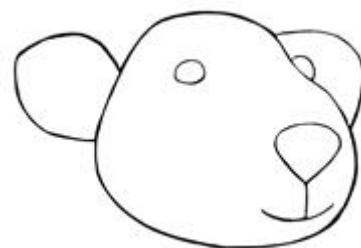

2.3

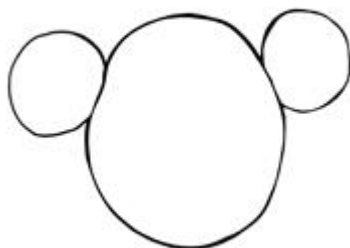

2.4

Design 3

- (54) **Produkt:** Figurine
(51) **Klasse:** 11-02
(72) **Designer:** Gry Højgaard Staunstrup, Jordmoderstien 21, 4100 RINGSTED, Danmark
(55) **Designavbildninger:**



3.1



3.2

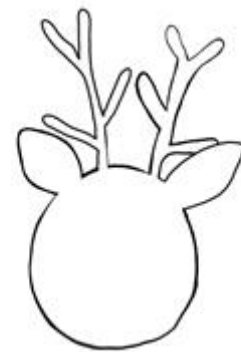

3.3



3.4

Design 4

- (54) **Produkt:** Figurine
(51) **Klasse:** 11-02
(72) **Designer:** Gry Højgaard Staunstrup, Jordmoderstien 21, 4100 RINGSTED, Danmark
(55) **Designavbildninger:**



4.1

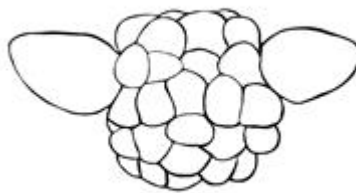

4.2



4.3

Design 5

- (54) **Produkt:** Figurine
(51) **Klasse:** 11-02
(72) **Designer:** Gry Højgaard Staunstrup, Jordmoderstien 21, 4100 RINGSTED, Danmark
(55) **Designavbildninger:**

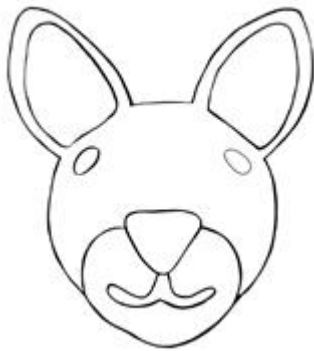

5.1



5.2



5.3

Design 6

- (54) **Produkt:** Festive decoration
(51) **Klasse:** 11-05
(72) **Designer:** Gry Højgaard Staunstrup, Jordmoderstien 21, 4100 RINGSTED, Danmark
(55) **Designavbildninger:**

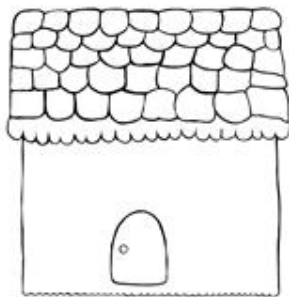

6.1



6.2



6.3



6.4

Design 7

- (54) **Produkt:** Festive decoration
(51) **Klasse:** 11-05
(72) **Designer:** Gry Højgaard Staunstrup, Jordmoderstien 21, 4100 RINGSTED, Danmark
(55) **Designavbildninger:**



7.1



7.2

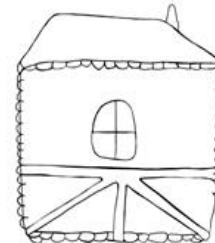

7.3



7.4

Design 8

- (54) **Produkt:** Artificial plant
(51) **Klasse:** 11-04
(72) **Designer:** Gry Højgaard Staunstrup, Jordmoderstien 21, 4100 RINGSTED, Danmark
(55) **Designavbildninger:**



8.1



8.2

Design 9

- (54) **Produkt:** Artificial plant
(51) **Klasse:** 11-04
(72) **Designer:** Gry Højgaard Staunstrup, Jordmoderstien 21, 4100 RINGSTED, Danmark
(55) **Designavbildninger:**



9.1



9.2

Design 10

- (54) **Produkt:** Festive decoration
(51) **Klasse:** 11-05
(72) **Designer:** Gry Højgaard Staunstrup, Jordmoderstien 21, 4100 RINGSTED, Danmark
(55) **Designavbildninger:**

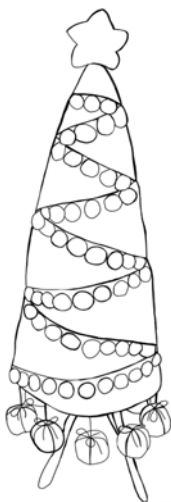

10.1

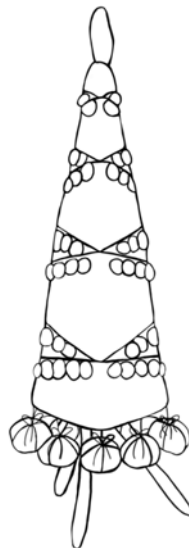

10.2

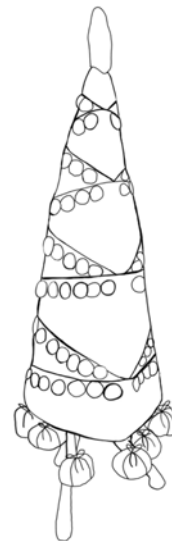

10.3

Design 11

- (54) **Produkt:** Figurine
(51) **Klasse:** 11-02
(72) **Designer:** Gry Højgaard Staunstrup, Jordmoderstien 21, 4100 RINGSTED, Danmark
(55) **Designavbildninger:**



11.1



11.2

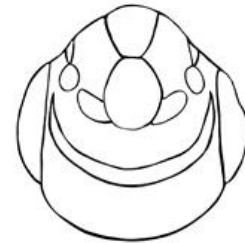

11.3

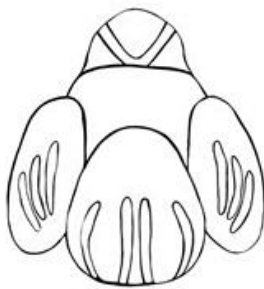

11.4

(11)	Reg.nr.:	DM/234135
(21)	Søkn.nr.:	20240007
(22)	Inngitt i WIPO:	2023.12.18
(15)	Registrert i WIPO:	2023.12.18
(24)	Løpedag:	2023.12.18
(43)	Allm. tilgj.:	2024.01.05
(15)	Besluttet gjeldende NO:	2024.01.12
(45)	Kunngjort NO:	2024.02.05
(18)	Reg. gjelder til:	2028.12.18
(73)	Innehaver:	N.V. Nutricia, Eerste Stationsstraat 186, 2712HM ZOETERMEER, Nederland
(50)	Anmerkninger:	Registreringen gjelder samregistrering

Design 1

(54)	Produkt:	Packaging for foodstuffs
(51)	Klasse:	09-03
(72)	Designer:	Cesar Augusto Rodrigues De Goes, R. Fradique Coutinho, 2207, SP 05416-012 PINHEIROS- SÃO PAULO, Brasil Daniel Souza, R. Fradique Coutinho, 2207, SP 05416-012 PINHEIROS ,SÃO PAULO, Brasil Mariane Da Silva Santos, R. Fradique Coutinho, 2207, SP 05416-012 PINHEIROS, SÃO PAULO, Brasil Marcello Garutti, R. Fábria, 528, SP 05051-030 VILA ROMANA, SÃO PAULO, Brasil
(30)	Prioritet:	2023.08.16, EM, 015031383, 1,2,3,4
(55)	Designavbildninger:	



1.1

Design 2

(54)	Produkt:	Ornamentation for foodstuffs packaging
(51)	Klasse:	09-03
(72)	Designer:	Cesar Augusto Rodrigues De Goes, R. Fradique Coutinho, 2207, SP 05416-012 PINHEIROS- SÃO PAULO, Brasil Daniel Souza, R. Fradique Coutinho, 2207, SP 05416-012 PINHEIROS ,SÃO PAULO, Brasil Mariane Da Silva Santos, R. Fradique Coutinho, 2207, SP 05416-012 PINHEIROS, SÃO PAULO, Brasil Marcello Garutti, R. Fábria, 528, SP 05051-030 VILA ROMANA, SÃO PAULO, Brasil
(30)	Prioritet:	2023.08.16, EM, 015031383, 1,2,3,4
(55)	Designavbildninger:	



2.1

Design 3

- (54) **Produkt:** Packaging for foodstuffs
(51) **Klasse:** 09-03
(72) **Designer:** Cesar Augusto Rodrigues De Goes, R. Fradique Coutinho, 2207, SP 05416-012 PINHEIROS- SÃO PAULO, Brasil
Daniel Souza, R. Fradique Coutinho, 2207, SP 05416-012 PINHEIROS ,SÃO PAULO, Brasil
Mariane Da Silva Santos, R. Fradique Coutinho, 2207, SP 05416-012 PINHEIROS, SÃO PAULO, Brasil
Marcello Garutti, R. Fábria, 528, SP 05051-030 VILA ROMANA, SÃO PAULO, Brasil
- (30) **Prioritet:** 2023.08.16, EM, 015031383, 1,2,3,4
(55) **Designavbildninger:**



3.1

Design 4

- (54) **Produkt:** Ornamentation for foodstuffs packaging
(51) **Klasse:** 09-03
(72) **Designer:** Cesar Augusto Rodrigues De Goes, R. Fradique Coutinho, 2207, SP 05416-012 PINHEIROS- SÃO PAULO, Brasil
Daniel Souza, R. Fradique Coutinho, 2207, SP 05416-012 PINHEIROS ,SÃO PAULO, Brasil
Mariane Da Silva Santos, R. Fradique Coutinho, 2207, SP 05416-012 PINHEIROS, SÃO PAULO, Brasil
Marcello Garutti, R. Fábria, 528, SP 05051-030 VILA ROMANA, SÃO PAULO, Brasil
- (30) **Prioritet:** 2023.08.16, EM, 015031383, 1,2,3,4
(55) **Designavbildninger:**



4.1

(11)	Reg.nr.:	DM/234136
(21)	Søkn.nr.:	20240008
(22)	Inngitt i WIPO:	2023.12.13
(15)	Registrert i WIPO:	2023.12.13
(24)	Løpedag:	2023.12.13
(43)	Allm. tilgj.:	2024.01.05
(15)	Besluttet gjeldende NO:	2024.01.12
(45)	Kunngjort NO:	2024.02.05
(18)	Reg. gjelder til:	2028.12.13
(73)	Innehaver:	Vålinge Innovation AB, Prästavägen 513, 26364 VIKEN, Sverige

Design 1

(54)	Produkt:	Dismantling tool
(51)	Klasse:	08-08
(72)	Designer:	Karl Quist, Polhemsgatan 8, 263 37 HÖGANÄS, Sverige
(30)	Prioritet:	2023.06.28, EM, 015026374, 1
(55)	Designavbildninger:	

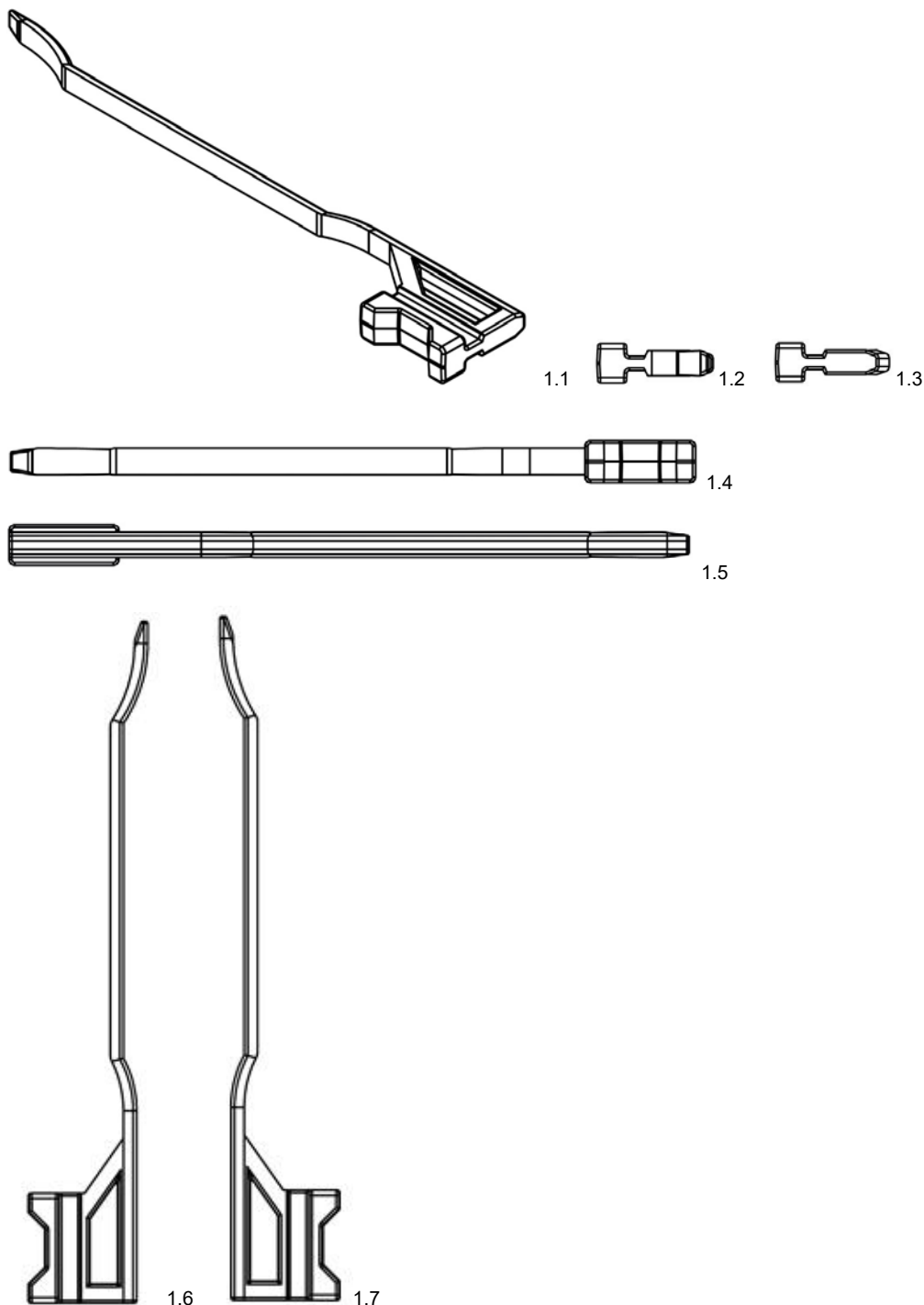

(11)	Reg.nr.:	DM/234138
(21)	Søkn.nr.:	20240009
(22)	Inngitt i WIPO:	2023.12.18
(15)	Registrert i WIPO:	2023.12.18
(24)	Løpedag:	2023.12.18
(43)	Allm. tilgj.:	2024.01.05
(15)	Besluttet gjeldende NO:	2024.01.15
(45)	Kunngjort NO:	2024.02.05
(18)	Reg. gjelder til:	2028.12.18
(73)	Innehaver:	N.V. Nutricia, Eerste Stationsstraat 186, 2712HM ZOETERMEER, Nederland
(50)	Anmerkninger:	Registreringen gjelder samregistrering

Design 1

(54)	Produkt:	Packaging for foodstuffs
(51)	Klasse:	09-03
(72)	Designer:	Cesar Augusto Rodrigues De Goes, R. Fradique Coutinho, 2207, SP 05416-012 PINHEIROS- SÃO PAULO, Brasil Daniel Souza, R. Fradique Coutinho, 2207, SP 05416-012 PINHEIROS ,SÃO PAULO, Brasil Mariane Da Silva Santos, R. Fradique Coutinho, 2207, SP 05416-012 PINHEIROS, SÃO PAULO, Brasil Marcello Garutti, R. Fábria, 528, SP 05051-030 VILA ROMANA, SÃO PAULO, Brasil
(30)	Prioritet:	2023.08.16, EM, 015031383, 1,2,3,4,5,6,7,8
(55)	Designavbildninger:	



1.1

Design 2

(54)	Produkt:	Ornamentation for foodstuffs packaging
(51)	Klasse:	09-03
(72)	Designer:	Cesar Augusto Rodrigues De Goes, R. Fradique Coutinho, 2207, SP 05416-012 PINHEIROS- SÃO PAULO, Brasil Daniel Souza, R. Fradique Coutinho, 2207, SP 05416-012 PINHEIROS ,SÃO PAULO, Brasil Mariane Da Silva Santos, R. Fradique Coutinho, 2207, SP 05416-012 PINHEIROS, SÃO PAULO, Brasil Marcello Garutti, R. Fábria, 528, SP 05051-030 VILA ROMANA, SÃO PAULO, Brasil
(30)	Prioritet:	2023.08.16, EM, 015031383, 1,2,3,4,5,6,7,8
(55)	Designavbildninger:	



2.1

Design 3

- (54) **Produkt:** Ornamentation for foodstuffs packaging
(51) **Klasse:** 09-03
(72) **Designer:** Cesar Augusto Rodrigues De Goes, R. Fradique Coutinho, 2207, SP 05416-012 PINHEIROS- SÃO PAULO, Brasil
Daniel Souza, R. Fradique Coutinho, 2207, SP 05416-012 PINHEIROS ,SÃO PAULO, Brasil
Mariane Da Silva Santos, R. Fradique Coutinho, 2207, SP 05416-012 PINHEIROS, SÃO PAULO, Brasil
Marcello Garutti, R. Fábria, 528, SP 05051-030 VILA ROMANA, SÃO PAULO, Brasil
- (30) **Prioritet:** 2023.08.16, EM, 015031383, 1,2,3,4,5,6,7,8
(55) **Designavbildninger:**

**Design 4**

- (54) **Produkt:** Ornamentation for foodstuffs packaging
(51) **Klasse:** 09-03
(72) **Designer:** Cesar Augusto Rodrigues De Goes, R. Fradique Coutinho, 2207, SP 05416-012 PINHEIROS- SÃO PAULO, Brasil
Daniel Souza, R. Fradique Coutinho, 2207, SP 05416-012 PINHEIROS ,SÃO PAULO, Brasil
Mariane Da Silva Santos, R. Fradique Coutinho, 2207, SP 05416-012 PINHEIROS, SÃO PAULO, Brasil
Marcello Garutti, R. Fábria, 528, SP 05051-030 VILA ROMANA, SÃO PAULO, Brasil
- (30) **Prioritet:** 2023.08.16, EM, 015031383, 1,2,3,4,5,6,7,8
(55) **Designavbildninger:**



Design 5

- (54) **Produkt:** Packaging for foodstuffs
 (51) **Klasse:** 09-03
 (72) **Designer:** Cesar Augusto Rodrigues De Goes, R. Fradique Coutinho, 2207, SP 05416-012 PINHEIROS- SÃO PAULO, Brasil
 Daniel Souza, R. Fradique Coutinho, 2207, SP 05416-012 PINHEIROS ,SÃO PAULO, Brasil
 Mariane Da Silva Santos, R. Fradique Coutinho, 2207, SP 05416-012 PINHEIROS, SÃO PAULO, Brasil
 Marcello Garutti, R. Fábria, 528, SP 05051-030 VILA ROMANA, SÃO PAULO, Brasil
- (30) **Prioritet:** 2023.08.16, EM, 015031383, 1,2,3,4,5,6,7,8
 (55) **Designavbildninger:**



5.1

Design 6

- (54) **Produkt:** Ornamentation for foodstuffs packaging
 (51) **Klasse:** 09-03
 (72) **Designer:** Cesar Augusto Rodrigues De Goes, R. Fradique Coutinho, 2207, SP 05416-012 PINHEIROS- SÃO PAULO, Brasil
 Daniel Souza, R. Fradique Coutinho, 2207, SP 05416-012 PINHEIROS ,SÃO PAULO, Brasil
 Mariane Da Silva Santos, R. Fradique Coutinho, 2207, SP 05416-012 PINHEIROS, SÃO PAULO, Brasil
 Marcello Garutti, R. Fábria, 528, SP 05051-030 VILA ROMANA, SÃO PAULO, Brasil
- (30) **Prioritet:** 2023.08.16, EM, 015031383, 1,2,3,4,5,6,7,8
 (55) **Designavbildninger:**



6.1

Design 7

- (54) **Produkt:** Ornamentation for foodstuffs packaging
 (51) **Klasse:** 09-03
 (72) **Designer:** Cesar Augusto Rodrigues De Goes, R. Fradique Coutinho, 2207, SP 05416-012 PINHEIROS- SÃO PAULO, Brasil
 Daniel Souza, R. Fradique Coutinho, 2207, SP 05416-012 PINHEIROS ,SÃO PAULO, Brasil
 Mariane Da Silva Santos, R. Fradique Coutinho, 2207, SP 05416-012 PINHEIROS, SÃO PAULO, Brasil
 Marcello Garutti, R. Fábria, 528, SP 05051-030 VILA ROMANA, SÃO PAULO, Brasil
- (30) **Prioritet:** 2023.08.16, EM, 015031383, 1,2,3,4,5,6,7,8
 (55) **Designavbildninger:**



7.1

Design 8

- (54) **Produkt:** Ornamentation for foodstuffs packaging
(51) **Klasse:** 09-03
(72) **Designer:** Cesar Augusto Rodrigues De Goes, R. Fradique Coutinho, 2207, SP 05416-012 PINHEIROS- SÃO PAULO, Brasil
Daniel Souza, R. Fradique Coutinho, 2207, SP 05416-012 PINHEIROS ,SÃO PAULO, Brasil
Mariane Da Silva Santos, R. Fradique Coutinho, 2207, SP 05416-012 PINHEIROS, SÃO PAULO, Brasil
Marcello Garutti, R. Fábria, 528, SP 05051-030 VILA ROMANA, SÃO PAULO, Brasil
- (30) **Prioritet:** 2023.08.16, EM, 015031383, 1,2,3,4,5,6,7,8
(55) **Designavbildninger:**



8.1

(11)	Reg.nr.:	DM/234139
(21)	Søkn.nr.:	20240010
(22)	Inngitt i WIPO:	2023.12.18
(15)	Registrert i WIPO:	2023.12.18
(24)	Løpedag:	2023.12.18
(43)	Allm. tilgj.:	2024.01.05
(15)	Besluttet gjeldende NO:	2024.01.15
(45)	Kunngjort NO:	2024.02.05
(18)	Reg. gjelder til:	2028.12.18
(73)	Innehaver:	N.V. Nutricia, Eerste Stationsstraat 186, 2712HM ZOETERMEER, Nederland
(50)	Anmerkninger:	Registreringen gjelder samregistrering

Design 1

(54)	Produkt:	Packaging for foodstuffs
(51)	Klasse:	09-03
(72)	Designer:	Cesar Augusto Rodrigues De Goes, R. Fradique Coutinho, 2207, SP 05416-012 PINHEIROS- SÃO PAULO, Brasil Daniel Souza, R. Fradique Coutinho, 2207, SP 05416-012 PINHEIROS ,SÃO PAULO, Brasil Mariane Da Silva Santos, R. Fradique Coutinho, 2207, SP 05416-012 PINHEIROS, SÃO PAULO, Brasil Marcello Garutti, R. Fábria, 528, SP 05051-030 VILA ROMANA, SÃO PAULO, Brasil
(30)	Prioritet:	2023.08.16, EM, 015031383, 1,2,3,4,5,6,7,8,9,10
(55)	Designavbildninger:	



1.1

Design 2

(54)	Produkt:	Ornamentation for foodstuffs packaging
(51)	Klasse:	09-03
(72)	Designer:	Cesar Augusto Rodrigues De Goes, R. Fradique Coutinho, 2207, SP 05416-012 PINHEIROS- SÃO PAULO, Brasil Daniel Souza, R. Fradique Coutinho, 2207, SP 05416-012 PINHEIROS ,SÃO PAULO, Brasil Mariane Da Silva Santos, R. Fradique Coutinho, 2207, SP 05416-012 PINHEIROS, SÃO PAULO, Brasil Marcello Garutti, R. Fábria, 528, SP 05051-030 VILA ROMANA, SÃO PAULO, Brasil
(30)	Prioritet:	2023.08.16, EM, 015031383, 1,2,3,4,5,6,7,8,9,10
(55)	Designavbildninger:	



2.1

Design 3

- (54) **Produkt:** Ornamentation for foodstuffs packaging
(51) **Klasse:** 09-03
(72) **Designer:** Cesar Augusto Rodrigues De Goes, R. Fradique Coutinho, 2207, SP 05416-012 PINHEIROS- SÃO PAULO, Brasil
Daniel Souza, R. Fradique Coutinho, 2207, SP 05416-012 PINHEIROS ,SÃO PAULO, Brasil
Mariane Da Silva Santos, R. Fradique Coutinho, 2207, SP 05416-012 PINHEIROS, SÃO PAULO, Brasil
Marcello Garutti, R. Fábria, 528, SP 05051-030 VILA ROMANA, SÃO PAULO, Brasil
- (30) **Prioritet:** 2023.08.16, EM, 015031383, 1,2,3,4,5,6,7,8,9,10
(55) **Designavbildninger:**



3.1

Design 4

- (54) **Produkt:** Ornamentation for foodstuffs packaging
(51) **Klasse:** 09-03
(72) **Designer:** Cesar Augusto Rodrigues De Goes, R. Fradique Coutinho, 2207, SP 05416-012 PINHEIROS- SÃO PAULO, Brasil
Daniel Souza, R. Fradique Coutinho, 2207, SP 05416-012 PINHEIROS ,SÃO PAULO, Brasil
Mariane Da Silva Santos, R. Fradique Coutinho, 2207, SP 05416-012 PINHEIROS, SÃO PAULO, Brasil
Marcello Garutti, R. Fábria, 528, SP 05051-030 VILA ROMANA, SÃO PAULO, Brasil
- (30) **Prioritet:** 2023.08.16, EM, 015031383, 1,2,3,4,5,6,7,8,9,10
(55) **Designavbildninger:**



4.1

Design 5

- (54) **Produkt:** Packaging for foodstuffs
(51) **Klasse:** 09-03
(72) **Designer:** Cesar Augusto Rodrigues De Goes, R. Fradique Coutinho, 2207, SP 05416-012 PINHEIROS- SÃO PAULO, Brasil
Daniel Souza, R. Fradique Coutinho, 2207, SP 05416-012 PINHEIROS ,SÃO PAULO, Brasil
Mariane Da Silva Santos, R. Fradique Coutinho, 2207, SP 05416-012 PINHEIROS, SÃO PAULO, Brasil
Marcello Garutti, R. Fábria, 528, SP 05051-030 VILA ROMANA, SÃO PAULO, Brasil
- (30) **Prioritet:** 2023.08.16, EM, 015031383, 1,2,3,4,5,6,7,8,9,10
(55) **Designavbildninger:**



5.1

Design 6

- (54) **Produkt:** Ornamentation for foodstuffs packaging
(51) **Klasse:** 09-03
(72) **Designer:** Cesar Augusto Rodrigues De Goes, R. Fradique Coutinho, 2207, SP 05416-012 PINHEIROS- SÃO PAULO, Brasil
Daniel Souza, R. Fradique Coutinho, 2207, SP 05416-012 PINHEIROS ,SÃO PAULO, Brasil
Mariane Da Silva Santos, R. Fradique Coutinho, 2207, SP 05416-012 PINHEIROS, SÃO PAULO, Brasil
Marcello Garutti, R. Fábria, 528, SP 05051-030 VILA ROMANA, SÃO PAULO, Brasil
- (30) **Prioritet:** 2023.08.16, EM, 015031383, 1,2,3,4,5,6,7,8,9,10
(55) **Designavbildninger:**



6.1

Design 7

- (54) **Produkt:** Ornamentation for foodstuffs packaging
(51) **Klasse:** 09-03
(72) **Designer:** Cesar Augusto Rodrigues De Goes, R. Fradique Coutinho, 2207, SP 05416-012 PINHEIROS- SÃO PAULO, Brasil
Daniel Souza, R. Fradique Coutinho, 2207, SP 05416-012 PINHEIROS ,SÃO PAULO, Brasil
Mariane Da Silva Santos, R. Fradique Coutinho, 2207, SP 05416-012 PINHEIROS, SÃO PAULO, Brasil
Marcello Garutti, R. Fábria, 528, SP 05051-030 VILA ROMANA, SÃO PAULO, Brasil
- (30) **Prioritet:** 2023.08.16, EM, 015031383, 1,2,3,4,5,6,7,8,9,10
(55) **Designavbildninger:**



7.1

Design 8

- (54) **Produkt:** Ornamentation for foodstuffs packaging
(51) **Klasse:** 09-03
(72) **Designer:** Cesar Augusto Rodrigues De Goes, R. Fradique Coutinho, 2207, SP 05416-012 PINHEIROS- SÃO PAULO, Brasil
Daniel Souza, R. Fradique Coutinho, 2207, SP 05416-012 PINHEIROS ,SÃO PAULO, Brasil
Mariane Da Silva Santos, R. Fradique Coutinho, 2207, SP 05416-012 PINHEIROS, SÃO PAULO, Brasil
Marcello Garutti, R. Fábria, 528, SP 05051-030 VILA ROMANA, SÃO PAULO, Brasil
- (30) **Prioritet:** 2023.08.16, EM, 015031383, 1,2,3,4,5,6,7,8,9,10
(55) **Designavbildninger:**



8.1

Design 9

- (54) **Produkt:** Packaging for foodstuffs
(51) **Klasse:** 09-03
(72) **Designer:** Cesar Augusto Rodrigues De Goes, R. Fradique Coutinho, 2207, SP 05416-012 PINHEIROS- SÃO PAULO, Brasil
Daniel Souza, R. Fradique Coutinho, 2207, SP 05416-012 PINHEIROS ,SÃO PAULO, Brasil
Mariane Da Silva Santos, R. Fradique Coutinho, 2207, SP 05416-012 PINHEIROS, SÃO PAULO, Brasil
Marcello Garutti, R. Fábria, 528, SP 05051-030 VILA ROMANA, SÃO PAULO, Brasil
- (30) **Prioritet:** 2023.08.16, EM, 015031383, 1,2,3,4,5,6,7,8,9,10
(55) **Designavbildninger:**



9.1

Design 10

- (54) **Produkt:** Ornamentation for foodstuffs packaging
(51) **Klasse:** 09-03
(72) **Designer:** Cesar Augusto Rodrigues De Goes, R. Fradique Coutinho, 2207, SP 05416-012 PINHEIROS- SÃO PAULO, Brasil
Daniel Souza, R. Fradique Coutinho, 2207, SP 05416-012 PINHEIROS ,SÃO PAULO, Brasil
Mariane Da Silva Santos, R. Fradique Coutinho, 2207, SP 05416-012 PINHEIROS, SÃO PAULO, Brasil
Marcello Garutti, R. Fábria, 528, SP 05051-030 VILA ROMANA, SÃO PAULO, Brasil
- (30) **Prioritet:** 2023.08.16, EM, 015031383, 1,2,3,4,5,6,7,8,9,10
(55) **Designavbildninger:**



10.1

(11)	Reg.nr.:	DM/234142
(21)	Søkn.nr.:	20240011
(22)	Inngitt i WIPO:	2023.12.18
(15)	Registrert i WIPO:	2023.12.18
(24)	Løpedag:	2023.12.18
(43)	Allm. tilgj.:	2024.01.05
(15)	Besluttet gjeldende NO:	2024.01.15
(45)	Kunngjort NO:	2024.02.05
(18)	Reg. gjelder til:	2028.12.18
(73)	Innehaver:	N.V. Nutricia, Eerste Stationsstraat 186, 2712HM ZOETERMEER, Nederland
(50)	Anmerkninger:	Registreringen gjelder samregistrering

Design 1

(54)	Produkt:	Packaging for foodstuffs
(51)	Klasse:	09-03
(72)	Designer:	Cesar Augusto Rodrigues De Goes, R. Fradique Coutinho, 2207, SP 05416-012 PINHEIROS- SÃO PAULO, Brasil Daniel Souza, R. Fradique Coutinho, 2207, SP 05416-012 PINHEIROS ,SÃO PAULO, Brasil Mariane Da Silva Santos, R. Fradique Coutinho, 2207, SP 05416-012 PINHEIROS, SÃO PAULO, Brasil Marcello Garutti, R. Fábria, 528, SP 05051-030 VILA ROMANA, SÃO PAULO, Brasil
(30)	Prioritet:	2023.08.16, EM, 015031383, 1,2,3,4
(55)	Designavbildninger:	



1.1

Design 2

(54)	Produkt:	Ornamentation for foodstuffs packaging
(51)	Klasse:	09-03
(72)	Designer:	Cesar Augusto Rodrigues De Goes, R. Fradique Coutinho, 2207, SP 05416-012 PINHEIROS- SÃO PAULO, Brasil Daniel Souza, R. Fradique Coutinho, 2207, SP 05416-012 PINHEIROS ,SÃO PAULO, Brasil Mariane Da Silva Santos, R. Fradique Coutinho, 2207, SP 05416-012 PINHEIROS, SÃO PAULO, Brasil Marcello Garutti, R. Fábria, 528, SP 05051-030 VILA ROMANA, SÃO PAULO, Brasil
(30)	Prioritet:	2023.08.16, EM, 015031383, 1,2,3,4
(55)	Designavbildninger:	



2.1

Design 3

- (54) **Produkt:** Ornamentation for foodstuffs packaging
(51) **Klasse:** 09-03
(72) **Designer:** Cesar Augusto Rodrigues De Goes, R. Fradique Coutinho, 2207, SP 05416-012 PINHEIROS- SÃO PAULO, Brasil
Daniel Souza, R. Fradique Coutinho, 2207, SP 05416-012 PINHEIROS ,SÃO PAULO, Brasil
Mariane Da Silva Santos, R. Fradique Coutinho, 2207, SP 05416-012 PINHEIROS, SÃO PAULO, Brasil
Marcello Garutti, R. Fábria, 528, SP 05051-030 VILA ROMANA, SÃO PAULO, Brasil
- (30) **Prioritet:** 2023.08.16, EM, 015031383, 1,2,3,4
(55) **Designavbildninger:**

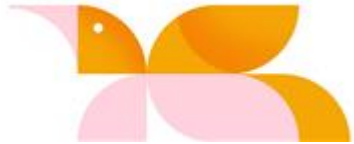

3.1

Design 4

- (54) **Produkt:** Ornamentation for foodstuffs packaging
(51) **Klasse:** 09-03
(72) **Designer:** Cesar Augusto Rodrigues De Goes, R. Fradique Coutinho, 2207, SP 05416-012 PINHEIROS- SÃO PAULO, Brasil
Daniel Souza, R. Fradique Coutinho, 2207, SP 05416-012 PINHEIROS ,SÃO PAULO, Brasil
Mariane Da Silva Santos, R. Fradique Coutinho, 2207, SP 05416-012 PINHEIROS, SÃO PAULO, Brasil
Marcello Garutti, R. Fábria, 528, SP 05051-030 VILA ROMANA, SÃO PAULO, Brasil
- (30) **Prioritet:** 2023.08.16, EM, 015031383, 1,2,3,4
(55) **Designavbildninger:**



4.1

(11)	Reg.nr.:	DM/234154
(21)	Søkn.nr.:	20240012
(22)	Inngitt i WIPO:	2023.12.18
(15)	Registrert i WIPO:	2023.12.18
(24)	Løpedag:	2023.12.18
(43)	Allm. tilgj.:	2024.01.05
(15)	Besluttet gjeldende NO:	2024.01.17
(45)	Kunngjort NO:	2024.02.05
(18)	Reg. gjelder til:	2028.12.18
(73)	Innehaver:	Continental Reifen Deutschland GmbH, Continental-Plaza 1, 30175 HANNOVER, Tyskland

Design 1

(54)	Produkt:	Vehicle tyre
(51)	Klasse:	12-15
(72)	Designer:	Claudia Bauer, Jädekamp 30, 30419 HANNOVER, Tyskland Lubomir Pagac, Terezie Vansovej 1054, 02001 PUCHOV, Slovakia
(30)	Prioritet:	2023.12.04, EM, 015043176, 1
(55)	Designavbildninger:	

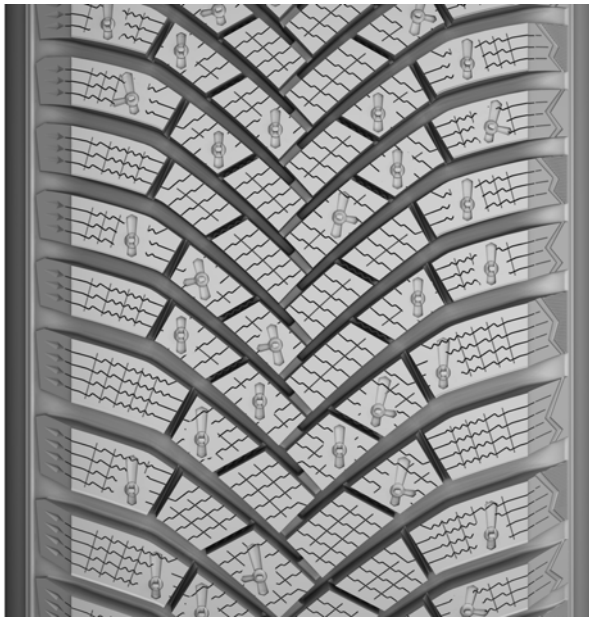

1.1



1.2



1.3



1.4



1.5



1.6

(11)	Reg.nr.:	DM/234173
(21)	Søkn.nr.:	20240020
(22)	Inngitt i WIPO:	2023.11.29
(15)	Registrert i WIPO:	2023.11.29
(24)	Løpedag:	2023.11.29
(43)	Allm. tilgj.:	2024.01.12
(15)	Besluttet gjeldende NO:	2024.01.17
(45)	Kunngjort NO:	2024.02.05
(18)	Reg. gjelder til:	2028.11.29
(73)	Innehaver:	EPORT technology CO., LTD., No. 1-104 (in Anji Bamboo Expo Park Co., Ltd.) (self-declaration), No. 1, Zhuboyuan Road, Lingfeng Street, ANJI COUNTY HUZHOU, Kina

Design 1

(54)	Produkt:	Energy storage device
(51)	Klasse:	13-02
(72)	Designer:	Zhen DAI, No. 1-104 (in Anji Bamboo Expo Park Co., Ltd.) (self-declaration), No. 1, Zhuboyuan Road, Lingfeng Street, Anji County, HUZHOU, Kina Chunxiang WANG, No. 1-104 (in Anji Bamboo Expo Park Co., Ltd.) (self-declaration), No. 1, Zhuboyuan Road, Lingfeng Street, Anji County, HUZHOU, Kina Hongjie LIU, No. 1-104 (in Anji Bamboo Expo Park Co., Ltd.) (self-declaration), No. 1, Zhuboyuan Road, Lingfeng Street, Anji County, HUZHOU, Kina Jie CHENG, No. 1-104 (in Anji Bamboo Expo Park Co., Ltd.) (self-declaration), No. 1, Zhuboyuan Road, Lingfeng Street, Anji County, HUZHOU, Kina Gongping TU, No. 1-104 (in Anji Bamboo Expo Park Co., Ltd.) (self-declaration), No. 1, Zhuboyuan Road, Lingfeng Street, Anji County, HUZHOU, Kina Chunyu ZHANG, No. 1-104 (in Anji Bamboo Expo Park Co., Ltd.) (self-declaration), No. 1, Zhuboyuan Road, Lingfeng Street, Anji County, HUZHOU, Kina Xinyu WEI, No. 1-104 (in Anji Bamboo Expo Park Co., Ltd.) (self-declaration), No. 1, Zhuboyuan Road, Lingfeng Street, Anji County, HUZHOU, Kina
(30)	Prioritet:	2023.10.26, CN, 202330697628.1, 1
(55)	Designavbildninger:	

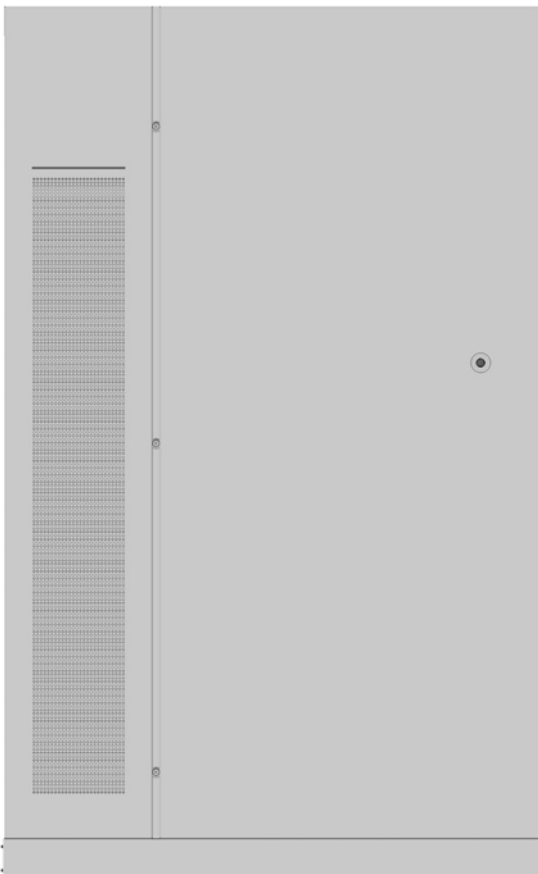

1.1

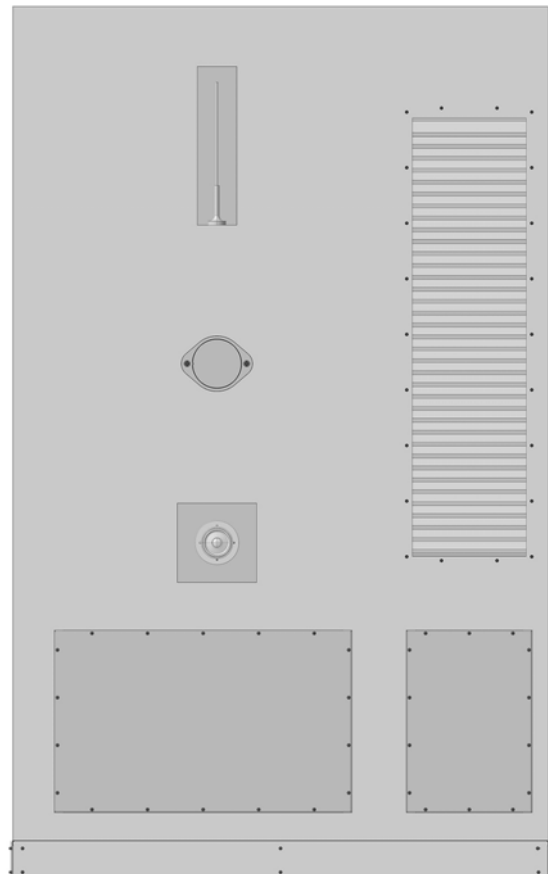

1.2



1.3

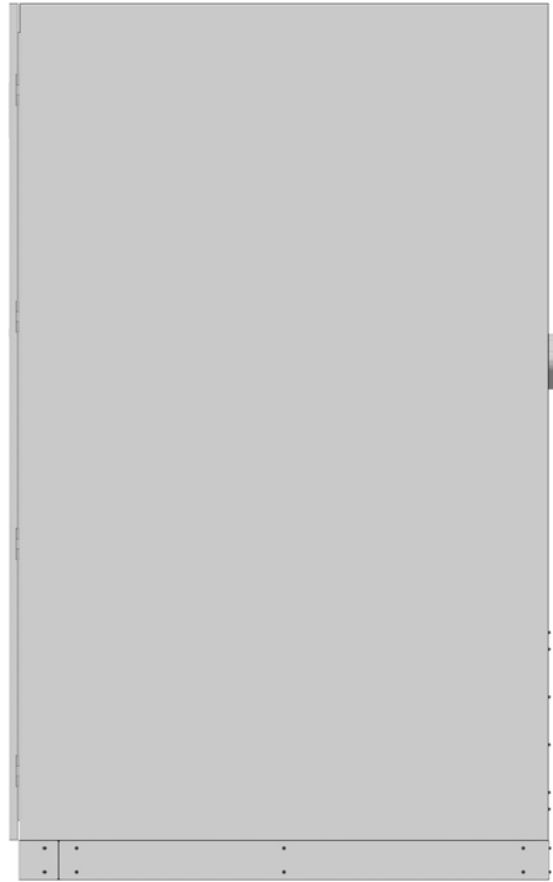

1.4

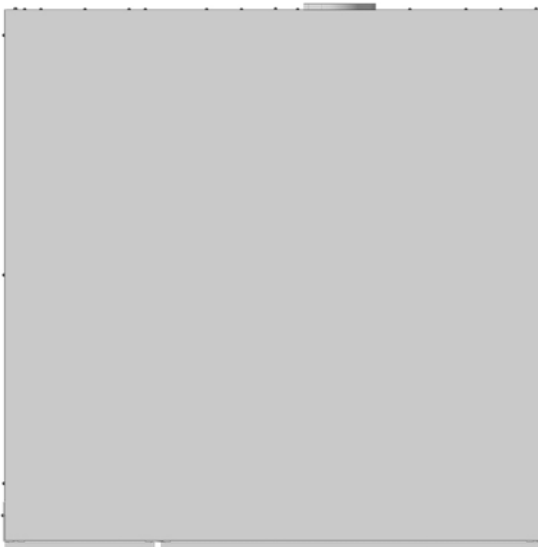

1.5

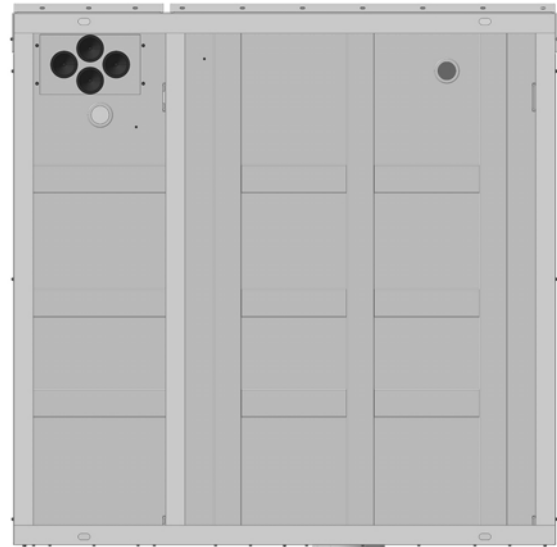

1.6

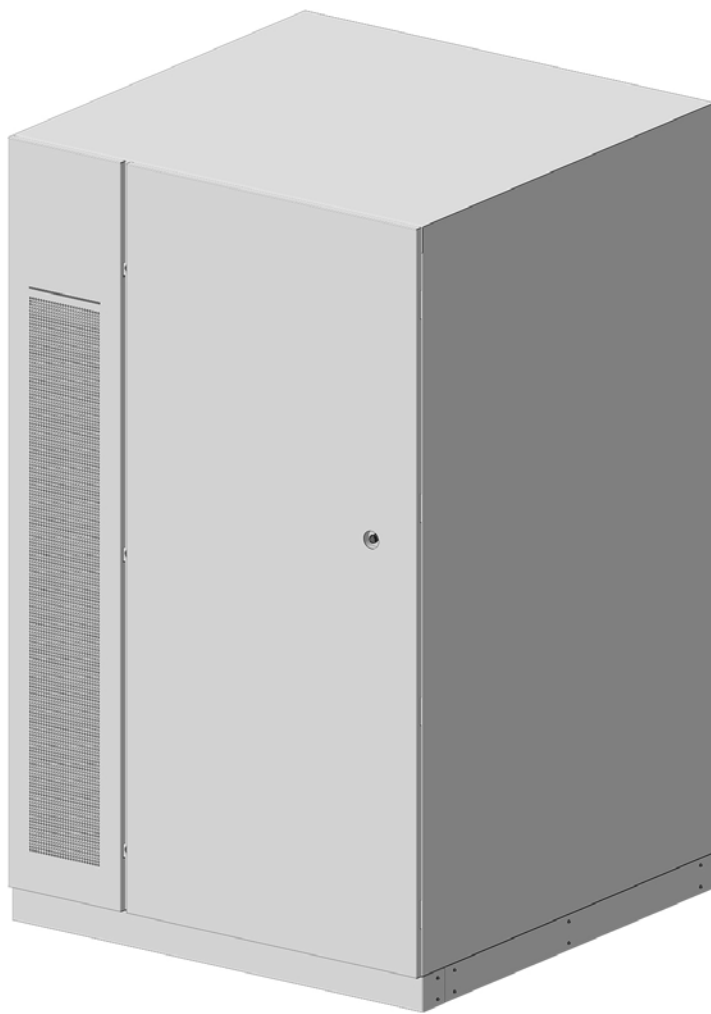

1.7

- (11) **Reg.nr.:** DM/234271
- (21) **Søkn.nr.:** 20240021
- (22) **Inngitt i WIPO:** 2023.12.22
- (15) **Registrert i WIPO:** 2023.12.22
- (24) **Løpedag:** 2023.12.22
- (43) **Allm. tilgj.:** 2024.01.12
- (15) **Besluttet gjeldende NO:** 2024.01.17
- (45) **Kunngjort NO:** 2024.02.05
- (18) **Reg. gjelder til:** 2028.12.22
- (73) **Innehaver:** ADEL KALEMCILIK TICARET VE SANAYI ANONIM SIRKETI, FATI H SULTAN MEHMET MAH. BALKAN CAD. BUYAKA E BLOK 58/14, ÜMRANIYE ISTANBUL, Tyrkia
- (50) **Anmerkninger:** Registreringen gjelder samregistrering

Design 1

- (54) **Produkt:** Packaging carton
- (51) **Klasse:** 09-03
- (72) **Designer:** SONER AKIN, FATI H SULTAN MEHMET MAH. BALKAN CAD. BUYAKA E BLOK 58/14, ÜMRANIYE ISTANBUL, Tyrkia
CENGİZ KESKİN, FATI H SULTAN MEHMET MAH. BALKAN CAD. BUYAKA E BLOK 58/14, ÜMRANIYE ISTANBUL, Tyrkia
- (30) **Prioritet:** 2023.07.06, TR, 2023/006623, 1,3,4,5
- (55) **Designavbildninger:**

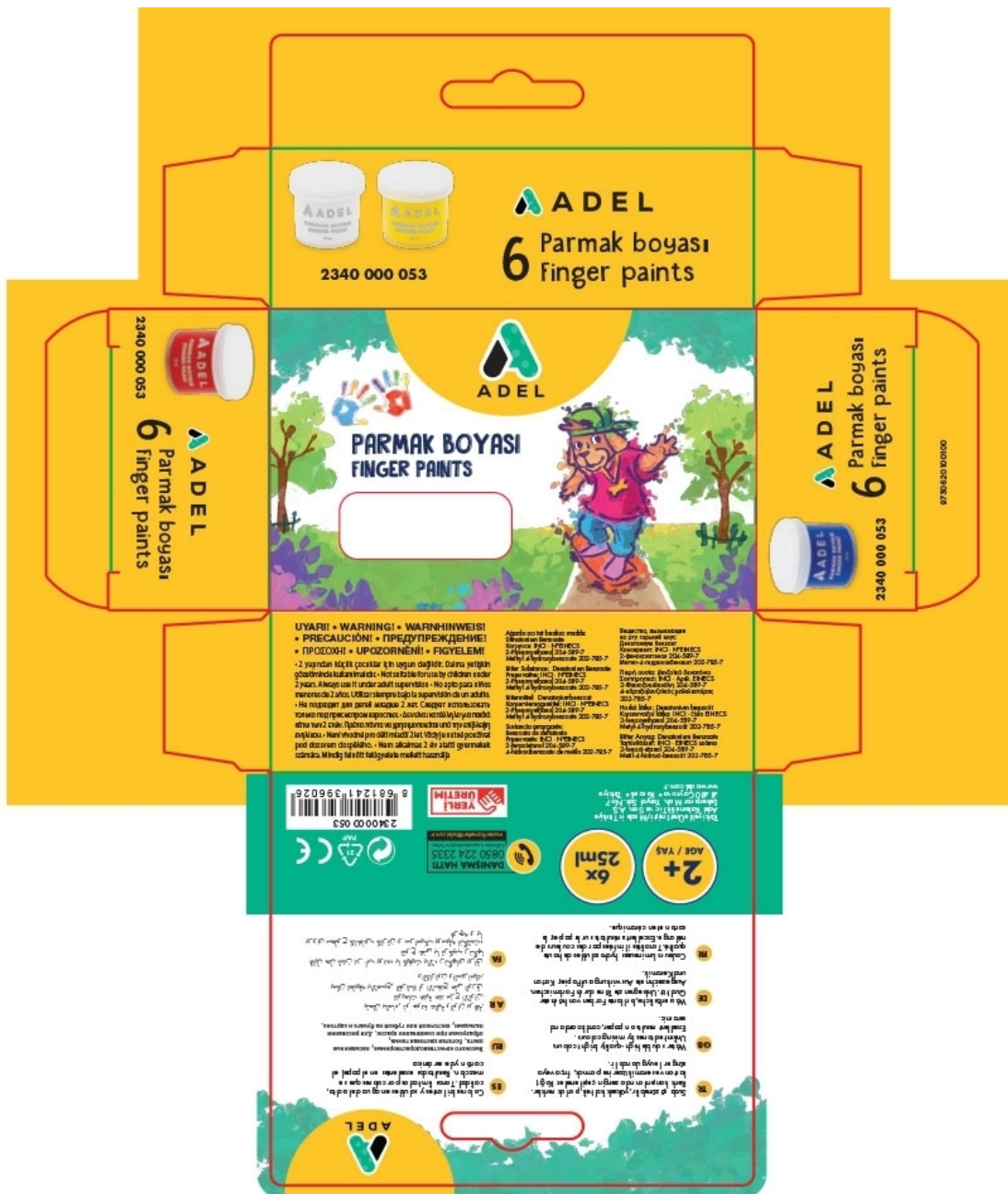

Design 2

- (54) **Produkt:** Packaging carton
 (51) **Klasse:** 09-03
 (72) **Designer:** SONER AKIN, FATIYH SULTAN MEHMET MAH. BALKAN CAD. BUYAKA E BLOK 58/14, ÜMRANIYE ISTANBUL, Tyrkia
 CENGİZ KESKİN, FATIYH SULTAN MEHMET MAH. BALKAN CAD. BUYAKA E BLOK 58/14, ÜMRANIYE ISTANBUL, Tyrkia
 2023.07.24, TR, 2023/007223, 2
- (30) **Prioritet:**
 (55) **Designavbildninger:**



Design 3

- (54) **Produkt:** Packaging carton
- (51) **Klasse:** 09-03
- (72) **Designer:** SONER AKIN, FATIYH SULTAN MEHMET MAH. BALKAN CAD. BUYAKA E BLOK 58/14, ÜMRANIYE ISTANBUL, Tyrkia
CENGİZ KESKİN, FATIYH SULTAN MEHMET MAH. BALKAN CAD. BUYAKA E BLOK 58/14, ÜMRANIYE ISTANBUL, Tyrkia
- (30) **Prioritet:** 2023.07.06, TR, 2023/006623, 1,3,4,5
- (55) **Designavbildninger:**



Design 4

- (54) **Produkt:** Packaging carton
 (51) **Klasse:** 09-03
 (72) **Designer:** SONER AKIN, FATIYH SULTAN MEHMET MAH. BALKAN CAD. BUYAKA E BLOK 58/14, ÜMRANIYE ISTANBUL, Tyrkia
 CENGİZ KESKİN, FATIYH SULTAN MEHMET MAH. BALKAN CAD. BUYAKA E BLOK 58/14, ÜMRANIYE ISTANBUL, Tyrkia
 (30) **Prioritet:** 2023.07.06, TR, 2023/006623, 1,3,4,5
 (55) **Designavbildninger:**



Design 5

- (54) **Produkt:** Packaging carton
(51) **Klasse:** 09-03
(72) **Designer:** SONER AKIN, FATIYH SULTAN MEHMET MAH. BALKAN CAD. BUYAKA E BLOK 58/14, ÜMRANIYE ISTANBUL, Tyrkia
CENGİZ KESKİN, FATIYH SULTAN MEHMET MAH. BALKAN CAD. BUYAKA E BLOK 58/14, ÜMRANIYE ISTANBUL, Tyrkia
(30) **Prioritet:** 2023.07.06, TR, 2023/006623, 1,3,4,5
(55) **Designavbildninger:**



5.1

Fornyelse av registreringer

(11) **Reg.nr.:** 078715
(73) **Innehaver:**
Les Robinets Presto, 7, rue Racine, 92120
MONTRouGE, Frankrike
(74) **Fullmektig:**
ZACCO NORWAY AS, Postboks 488, 0213 OSLO,
Norge

(11) **Reg.nr.:** 079335
(73) **Innehaver:**
Rockwool International A/S, Hovedgaden 584, Indgang
C, 2640 HEDEHUSENE, Danmark
(74) **Fullmektig:**
BRYN AARFLOT AS, Stortingsgata 8, 0161 OSLO,
Norge

(11) **Reg.nr.:** 081097
(18) **Reg. gjelder til:** 2023.02.25
(73) **Innehaver:**
Adax AS, Postboks 38, 3061 SVELVIK, Norge
(74) **Fullmektig:**
ZACCO NORWAY AS, Postboks 488, 0213 OSLO,
Norge

(11) **Reg.nr.:** 081733
(18) **Reg. gjelder til:** 2029.02.06
(73) **Innehaver:**
Mars Norge AS, Hovfaret 13, 0275 OSLO, Norge
(74) **Fullmektig:**
ONSAGERS AS, Postboks 1813, Vika, 0123 OSLO,
Norge

(11) **Reg.nr.:** 081742
(18) **Reg. gjelder til:** 2029.02.24
(73) **Innehaver:**
Nortura SA, Postboks 360 Økern, 0513 OSLO, Norge
(74) **Fullmektig:**
BRYN AARFLOT AS, Stortingsgata 8, 0161 OSLO,
Norge

(11) **Reg.nr.:** 081765
(18) **Reg. gjelder til:** 2029.03.04
(73) **Innehaver:**
Mars Norge AS, Hovfaret 13, 0275 OSLO, Norge
(74) **Fullmektig:**
ONSAGERS AS, Postboks 1813, Vika, 0123 OSLO,
Norge

(11) **Reg.nr.:** 081880
(18) **Reg. gjelder til:** 2029.01.21
(73) **Innehaver:**
Tod's SpA, Via Filippo Della Valle 1, 63019
SANT'ELPIDIO A MARE, ASCOLI PICENO, Italia
(74) **Fullmektig:**
ZACCO NORWAY AS, Postboks 488, 0213 OSLO,
Norge

(11) **Reg.nr.:** 081937
(18) **Reg. gjelder til:** 2029.05.12
(73) **Innehaver:**
Mars Norge AS, Hovfaret 13, 0275 OSLO, Norge
(74) **Fullmektig:**
ONSAGERS AS, Postboks 1813, Vika, 0123 OSLO,
Norge

(11) **Reg.nr.:** 081952
(18) **Reg. gjelder til:** 2029.05.28
(73) **Innehaver:**
Mars Norge AS, Hovfaret 13, 0275 OSLO, Norge
(74) **Fullmektig:**
ONSAGERS AS, Postboks 1813, Vika, 0123 OSLO,
Norge

(11) **Reg.nr.:** 081956
(18) **Reg. gjelder til:** 2029.06.05
(73) **Innehaver:**
Mars Norge AS, Hovfaret 13, 0275 OSLO, Norge
(74) **Fullmektig:**
ONSAGERS AS, Postboks 1813, Vika, 0123 OSLO,
Norge

(11) **Reg.nr.:** 081992
(18) **Reg. gjelder til:** 2029.06.17
(73) **Innehaver:**
Mars Norge AS, Hovfaret 13, 0275 OSLO, Norge
(74) **Fullmektig:**
ONSAGERS AS, Postboks 1813, Vika, 0123 OSLO,
Norge

(11) **Reg.nr.:** 082000
(18) **Reg. gjelder til:** 2029.07.21
(73) **Innehaver:**
Mars Norge AS, Hovfaret 13, 0275 OSLO, Norge
(74) **Fullmektig:**
ONSAGERS AS, Postboks 1813, Vika, 0123 OSLO,
Norge

(11) **Reg.nr.:** 082034
(18) **Reg. gjelder til:** 2029.08.19
(73) **Innehaver:**
Mars Norge AS, Hovfaret 13, 0275 OSLO, Norge
(74) **Fullmektig:**
ONSAGERS AS, Postboks 1813, Vika, 0123 OSLO,
Norge

(11) **Reg.nr.:** 082057
(18) **Reg. gjelder til:** 2029.08.27
(73) **Innehaver:**
Mars Norge AS, Hovfaret 13, 0275 OSLO, Norge
(74) **Fullmektig:**
ONSAGERS AS, Postboks 1813, Vika, 0123 OSLO,
Norge

(11) **Reg.nr.:** 082151
(18) **Reg. gjelder til:** 2029.10.22
(73) **Innehaver:**
Mars Norge AS, Hovfaret 13, 0275 OSLO, Norge
(74) **Fullmektig:**
ONSAGERS AS, Postboks 1813, Vika, 0123 OSLO,
Norge

(11) **Reg.nr.:** 082257
(18) **Reg. gjelder til:** 2029.12.15
(73) **Innehaver:**
Mars Norge AS, Hovfaret 13, 0275 OSLO, Norge
(74) **Fullmektig:**
ONSAGERS AS, Postboks 1813, Vika, 0123 OSLO,
Norge

(11) **Reg.nr.:** 084299
(18) **Reg. gjelder til:** 2029.02.10
(73) **Innehaver:**
Fresenius Kabi Deutschland GmbH, Else-Kröner-
Strasse 1, 61352 BAD HOMBURG, Tyskland
(74) **Fullmektig:**
ZACCO NORWAY AS, Postboks 488, 0213 OSLO,
Norge

(11) **Reg.nr.:** 084365
(18) **Reg. gjelder til:** 2029.03.24
(73) **Innehaver:**
Mill International AS, Grini Næringspark 12, 1361
ØSTERÅS, Norge
(74) **Fullmektig:**
ONSAAGERS AS, Postboks 1813, Vika, 0123 OSLO,
Norge

(11) **Reg.nr.:** 084392
(18) **Reg. gjelder til:** 2029.02.11
(73) **Innehaver:**
Anne Jorun Sæten, Harald Hårfages Gate 12, 5007
BERGEN, Norge
(74) **Fullmektig:**
HÅMSØ PATENTBYRÅ AS, Postboks 9, 4068
STAVANGER, Norge

(11) **Reg.nr.:** 084402
(18) **Reg. gjelder til:** 2029.03.04
(73) **Innehaver:**
Helnor AS, Postboks 74, 2361 RUDSHØGDA, Norge

(11) **Reg.nr.:** 084466
(18) **Reg. gjelder til:** 2029.01.31
(73) **Innehaver:**
Vestre AS, Postboks 49, Tåsen, 0801 OSLO, Norge
(74) **Fullmektig:**
ZACCO NORWAY AS, Postboks 488, 0213 OSLO,
Norge

(11) **Reg.nr.:** 084467
(18) **Reg. gjelder til:** 2029.01.31
(73) **Innehaver:**
Vestre AS, Postboks 49, Tåsen, 0801 OSLO, Norge
(74) **Fullmektig:**
ZACCO NORWAY AS, Postboks 488, 0213 OSLO,
Norge

(11) **Reg.nr.:** 084469
(18) **Reg. gjelder til:** 2029.01.31
(73) **Innehaver:**
Vestre AS, Postboks 49, Tåsen, 0801 OSLO, Norge
(74) **Fullmektig:**
ZACCO NORWAY AS, Postboks 488, 0213 OSLO,
Norge

(11) **Reg.nr.:** 086200
(18) **Reg. gjelder til:** 2029.01.16
(73) **Innehaver:**
LADAN NIKKHAH, H1020, LEIL.10063NÅKKVES VEI
1, 0670 OSLO, Norge

(11) **Reg.nr.:** 086221
(18) **Reg. gjelder til:** 2029.01.10
(73) **Innehaver:**
BYBYE DESIGN Bjørn Bye, Liljeveien 12, 1452
NESODDTANGEN, Norge
EGO DESIGN AS, C/O BitrafPostboks 4697
Sofienberg, 0506 OSLO, Norge

(11) **Reg.nr.:** 086223
(18) **Reg. gjelder til:** 2029.03.05
(73) **Innehaver:**
NORDLYS OF NORWAY AS, Slåbråtveien 29A, 1415
OPPEGÅRD, Norge

(11) **Reg.nr.:** 086332
(18) **Reg. gjelder til:** 2028.12.17
(73) **Innehaver:**
ELKO AS, Sandstuveien 68, 0680 OSLO, Norge
(74) **Fullmektig:**
Chéri Rehøj, c/o Schneider Electric Danmark A/S,
Lautrupvang 1, 2750 BALLERUP, Danmark

(11) **Reg.nr.:** 086367
(18) **Reg. gjelder til:** 2029.01.17
(73) **Innehaver:**
VESTRE AS, Drammensveien 44A, 0271 OSLO,
Norge
(74) **Fullmektig:**
ZACCO NORWAY AS, Postboks 488, 0213 OSLO,
Norge

(11) **Reg.nr.:** 086368
(18) **Reg. gjelder til:** 2029.01.17
(73) **Innehaver:**
VESTRE AS, Drammensveien 44A, 0271 OSLO,
Norge
(74) **Fullmektig:**
ZACCO NORWAY AS, Postboks 488, 0213 OSLO,
Norge

(11) **Reg.nr.:** 086369
(18) **Reg. gjelder til:** 2029.01.25
(73) **Innehaver:**
VESTRE AS, Drammensveien 44A, 0271 OSLO,
Norge
(74) **Fullmektig:**
ZACCO NORWAY AS, Postboks 488, 0213 OSLO,
Norge

(11) **Reg.nr.:** 086371
(18) **Reg. gjelder til:** 2029.01.25
(73) **Innehaver:**
VESTRE AS, Drammensveien 44A, 0271 OSLO,
Norge
(74) **Fullmektig:**
ZACCO NORWAY AS, Postboks 488, 0213 OSLO,
Norge

(11) **Reg.nr.:** 086372
(18) **Reg. gjelder til:** 2029.01.17
(73) **Innehaver:**
VESTRE AS, Drammensveien 44A, 0271 OSLO,
Norge
(74) **Fullmektig:**
ZACCO NORWAY AS, Postboks 488, 0213 OSLO,
Norge

(11) **Reg.nr.:** 086384
(18) **Reg. gjelder til:** 2029.02.04
(73) **Innehaver:**
VESTRE AS, Drammensveien 44A, 0271 OSLO,
Norge
(74) **Fullmektig:**
ZACCO NORWAY AS, Postboks 488, 0213 OSLO,
Norge

(11) **Reg.nr.:** 086386
(18) **Reg. gjelder til:** 2029.02.04
(73) **Innehaver:**
VESTRE AS, Drammensveien 44A, 0271 OSLO,
Norge
(74) **Fullmektig:**
ZACCO NORWAY AS, Postboks 488, 0213 OSLO,
Norge

(11) **Reg.nr.:** 086433
(18) **Reg. gjelder til:** 2029.03.25
(73) **Innehaver:**
Hexagon Ragasco AS, Postboks 50, 2831 RAUF OSS,
Norge
(74) **Fullmektig:**
ONSAGERS AS, Postboks 1813, Vika, 0123 OSLO,
Norge

(11) **Reg.nr.:** DM/082626
(18) **Reg. gjelder til:** 2024.01.08
(73) **Innehaver:**
Audi AG, 85045 INGOLSTADT, Tyskland

(11) **Reg.nr.:** DM/082714
(18) **Reg. gjelder til:** 2024.01.21
(73) **Innehaver:**
VM Distribuciones Industriales SL, Isla Alegranza 2,
nave 58, 28703 SAN SEBASTIAN DE LOS REYES,
Spania

(11) **Reg.nr.:** DM/083438
(18) **Reg. gjelder til:** 2023.12.30
(73) **Innehaver:**
Noureddine Maghnouj, Inlandsgatan 1E, 65344
KARLSTAD, Sverige

(11) **Reg.nr.:** DM/083590
(18) **Reg. gjelder til:** 2024.02.03
(73) **Innehaver:**
PRIMEBLADE SWEDEN AB, Box 70, 68622 SUNNE,
Sverige

(11) **Reg.nr.:** DM/200448
(18) **Reg. gjelder til:** 2024.01.09
(73) **Innehaver:**
L'OREAL, 14 rue Royale, 75008 PARIS, Frankrike

(11) **Reg.nr.:** DM/200778
(18) **Reg. gjelder til:** 2024.01.08
(73) **Innehaver:**
NMC SA, Gert-Noël-Strasse, 4731 EYNATTEN, Belgia

(11) **Reg.nr.:** DM/200800
(18) **Reg. gjelder til:** 2023.11.16
(73) **Innehaver:**
Hubbell Limited, Cannon Place 78 Cannon Street,
EC4N 6AF LONDON, Storbritannia

(11) **Reg.nr.:** DM/200930
(18) **Reg. gjelder til:** 2024.02.13
(73) **Innehaver:**
Volkswagen Aktiengesellschaft, Berliner Ring 2, 38440
WOLFSBURG, Tyskland

(11) **Reg.nr.:** DM/201492
(18) **Reg. gjelder til:** 2023.12.31
(73) **Innehaver:**
TOD'S S.P.A., Via Filippo Della Valle, 1, 63811
SANT'ELPIDIO A MARE (FM), Italia

(11) **Reg.nr.:** DM/201747
(18) **Reg. gjelder til:** 2024.01.16
(73) **Innehaver:**
OilQuick AB, Box 1055, 82412 HUDIKSVALL, Sverige

(11) **Reg.nr.:** DM/201773
(18) **Reg. gjelder til:** 2024.03.05
(73) **Innehaver:**
Drylock Technologies, naamloze vennootschap,
Spinnerijstraat 12, 9240 ZELE, Belgia

(11) **Reg.nr.:** DM/201863
(18) **Reg. gjelder til:** 2024.05.06
(73) **Innehaver:**
ANMAHU AB, Värtavägen 11, 11553 STOCKHOLM,
Sverige

(11) **Reg.nr.:** DM/202083
(18) **Reg. gjelder til:** 2024.01.15
(73) **Innehaver:**
Wavin B.V., Stationsplein 3, 8011CW ZWOLLE,
Nederland

(11) **Reg.nr.:** DM/202151
(18) **Reg. gjelder til:** 2024.01.04
(73) **Innehaver:**
MBG Holding GmbH, Oberes Feld 13, 33106
PADERBORN, Tyskland

(11) **Reg.nr.:** DM/206564
(18) **Reg. gjelder til:** 2024.01.24
(73) **Innehaver:**
Société des Produits Nestlé S.A., 1800 VEVEY, Sveits
(74) **Fullmektig:**
ZACCO NORWAY AS, Postboks 488, 0213 OSLO,
Norge

Overdragelser

Endring av innehaver, eller av innehavers navn og/eller adresse, i allment tilgjengelige designøknader og registrerte design, jf. designloven § 54 og designforskriften § 20.

(11) **Reg.nr.:** 083665
(21) **Søknadsnr.** 20120303
(73) **Innehaver:**
Erich Krause Holding Ltd, Dositheou, 7, Para Building,
Block A, Flat/Office 002, 1071 NICOSIA, Kypros
Melding innkommet patentstyret:
2024.01.10

(11) **Reg.nr.:** 087222
(21) **Søknadsnr.** 20211009
(73) **Innehaver:**
Stokke AS, Parkgata 6, 6003 ÅLESUND, Norge
(74) **Fullmektig:**
AWA NORWAY AS, Postboks 1052 Hoff, 0218 OSLO,
Norge
Melding innkommet patentstyret:
2024.01.11

Endringer i fullmaktsforhold

- (11) **Reg.nr.:** 087222
(21) **Søknadsnr.** 20211009
(73) **Innehaver:**
Stokke AS, Parkgata 6, 6003 ÅLESUND, Norge
(74) **Fullmektig:**
AWA NORWAY AS, Postboks 1052 Hoff, 0218 OSLO,
Norge
Melding innkommet patentstyret:
2024.01.11
-

Slettede, utgåtte og opphørte nasjonale designregistreringer

- (11) **Reg.nr.: 077778**
- (11) **Reg.nr.: 077938**
- (11) **Reg.nr.: 078008**
- (11) **Reg.nr.: 081389**
- (11) **Reg.nr.: 081565**
- (11) **Reg.nr.: 084049**
- (11) **Reg.nr.: 084051**
- (11) **Reg.nr.: 084067**
- (11) **Reg.nr.: 084069**
- (11) **Reg.nr.: 084159**
- (11) **Reg.nr.: 084190**
- (11) **Reg.nr.: 086072**
- (11) **Reg.nr.: 086167**

Slettede, utgåtte og opphørte internasjonale designregistreringer

- (11) **Reg.nr.:** DM/082203
(73) **Innehaver:**
Altura Leiden Holding B.V., Pascalstraat 12 A, 3771RT
BARNEVELD, Nederland
(75) **Adresse for korrespondanse:**
Meinrad Schmitt, Konrad-Zuse-Ring 32, 68163
MANNHEIM, Germany (DE)
-

- (11) **Reg.nr.:** DM/101826
(73) **Innehaver:**
Oras OY, Isometsäntie 2, 26100 RAUMA,
Finland###Hansa Armaturen GmbH, Sigmaringer Str.
107, 70567 STUTTGART, Tyskland
(75) **Adresse for korrespondanse:**
Hansa Armaturen GmbH, Sigmaringer Str. 107, 70567
STUTTGART, Germany (DE)
-

- (11) **Reg.nr.:** DM/101896
(73) **Innehaver:**
Hansa Armaturen GmbH, Sigmaringer Str. 107, 70567
STUTTGART, Tyskland
(75) **Adresse for korrespondanse:**
Oras OY, Isometsäntie 2, 26100 RAUMA, Finland (FI)
-

- (11) **Reg.nr.:** DM/101897
(73) **Innehaver:**
Pi-Design AG, Kantonsstrasse 100, 6234 TRIENGEN,
Sveits
(75) **Adresse for korrespondanse:**
Schreiber Hahn Sommerlad Rechtsanwälte PartG
mbH, Niedenau 13-19, 60325 FRANKFURT AM MAIN,
Germany (DE)
-

- (11) **Reg.nr.:** DM/101913
(73) **Innehaver:**
Scoot & Ride Holding GmbH, Steiffstrasse 1, 4710
GRIESKIRCHEN, Østerrike
(75) **Adresse for korrespondanse:**
Anwälte Burger und Partner Rechtsanwalt GmbH,
Rosenauerweg 16, 4580 WINDISCHGARSTEN,
Austria (AT)
-

- (11) **Reg.nr.:** DM/102456
(73) **Innehaver:**
SG ARMATUREN AS, Skytterheia 25, 4790
LILLESAND, Norge
(75) **Adresse for korrespondanse:**
SG ARMATUREN AS, Skytterheia 25, 4790
LILLESAND
-

- (11) **Reg.nr.:** DM/102905
(73) **Innehaver:**
NOVOLUTO GmbH, Am Kupfergraben 6a, 10117
BERLIN, Tyskland
(75) **Adresse for korrespondanse:**
KUHNNEN & WACKER Patent- und Rechtsanwaltsbüro
PartG mbB, Prinz-Ludwig-Strasse 40A, 85354
FREISING, Germany (DE)
-