

Norsk

design tidende

www.patentstyret.no

Norsk designtidende er en publikasjon som inneholder kunngjøringer innenfor designområdet

BESØKSADRESSE

- ▶ Sandakerveien 64

POSTADRESSE

- ▶ Postboks 4863 Nydalen
0422 Oslo

E-POST

- ▶ post@patentstyret.no

TELEFON

- ▶ +47 22 38 73 00
8.00-15.45

Innholdsfortegnelse:

Meddelelse til søker/innehaver med ukjent adresse	3
Registrerte design	4
Internasjonale designregistreringer	42
Fornyelse av registreringer	161
Slettede, utgåtte og opphørte nasjonale designregistreringer.....	164
Slettede, utgåtte og opphørte internasjonale designregistreringer.....	165

INID-koder

I kunngjøringene er de enkelte data forsynt med koder overensstemmende med INID-kodesystemet

(INID= Internationally agreed Numbers for the Identification of Data).

- (11) Registreringsnummer
- (15) Registreringsdato
- (18) Dato som registreringen gjelder til
- (21) Søknadsnummer
- (22) Inngivelsesdato
- (24) Løpedag
- (30) Prioritetsopplysninger
- (43) Allment tilgjengelig dato
- (51) Klasse
- (54) Produkt
- (55) Avbildning(er)
- (72) Designer
- (73) Innehaver
- (74) Fullmektig

Meddelelse til søker/innehaver med ukjent adresse

Meddelelse til innehaver av designregistrering nr. 085111, Det Lille Utdanningskontoret AS.
Det foreligger avgjørelse om opphør på grunn av ikke betalt fornyelsesavgift i designregistrering nr. 085111.
Avgjørelsen kan fås hos Patentstyret.

Registrerte design

I henhold til designloven § 18 første ledd i.f. kunngjøres i dag følgende registrerte design.

Det kan fremsettes krav om at designregistreringen helt eller delvis skal oppheves, jf. designloven §§ 25 flg. og designforskriften §§ 26 flg.

Designregistreringen gjelder for den eller de periodene på fem år som søknaden er innlevert for, regnet fra søknadsdagen. Registreringen kan fornyes, jf. designloven §§ 23 og 24. Maksimal beskyttelsestid er 25 år. For reservedeler, se unntaket i designloven § 23 annet ledd.

(11)	Reg.nr.:	087082
(21)	Søkn.nr.:	20210519
(22)	Inngitt:	2021.05.19
(24)	Løpedag:	2021.05.19
(43)	Allm. tilgj.:	2021.08.23
(15)	Registrert:	2021.08.23
(45)	Kunngjort:	2021.09.20
(18)	Reg. gjelder til:	2026.05.19
(73)	Innehaver:	Dr. Ing. h.c. F. Porsche Aktiengesellschaft, Porscheplatz 1, 70435 STUTTGART, Tyskland
(74)	Fullmektig:	ACAPO AS, Postboks 1880 Nordnes, 5817 BERGEN, Norge

Design 1

(54)	Produkt:	Felg
(51)	Klasse:	12-16
(72)	Designer:	Ingo Bauer-Scheinhütte, Mönshheimerweg 15, 71735 EBERDINGEN, Østerrike (AT) Julia Hübner, Wielandstraße 11, 70771 LEINFELDEN-ECHTERDINGEN, Tyskland (DE)
(55)	Designavbildninger:	



1.1



1.2



1.3



1.4



1.5



1.6



1.7

- (11) **Reg.nr.:** 087083
(21) **Søkn.nr.:** 20210518
(22) **Inngitt:** 2021.05.19
(24) **Løpedag:** 2021.05.19
(43) **Allm. tilgj.:** 2021.08.23
(15) **Registrert:** 2021.08.23
(45) **Kunngjort:** 2021.09.20
(18) **Reg. gjelder til:** 2026.05.19
(73) **Innehaver:** Dr. Ing. h.c. F. Porsche Aktiengesellschaft, Porscheplatz 1, 70435 STUTTGART, Tyskland
(74) **Fullmektig:** ACAPO AS, Postboks 1880 Nordnes, 5817 BERGEN, Norge

Design 1

- (54) **Produkt:** Felg
(51) **Klasse:** 12-16
(72) **Designer:** Julia Hübner, Wielandstraße 11, 70771 LEINFELDEN-ECHTERDINGEN, Tyskland (DE)
(55) **Designavbildninger:**



1.1



1.2



1.3



1.4



1.5



1.6



1.7

- (11) **Reg.nr.:** 087084
(21) **Søkn.nr.:** 20210515
(22) **Inngitt:** 2021.05.19
(24) **Løpedag:** 2021.05.19
(43) **Allm. tilgj.:** 2021.08.23
(15) **Registrert:** 2021.08.23
(45) **Kunngjort:** 2021.09.20
(18) **Reg. gjelder til:** 2026.05.19
(73) **Innehaver:** Dr. Ing. h.c. F. Porsche Aktiengesellschaft, Porscheplatz 1, 70435 STUTTGART, Tyskland
(74) **Fullmektig:** ACAPO AS, Postboks 1880 Nordnes, 5817 BERGEN, Norge

Design 1

- (54) **Produkt:** Felg
(51) **Klasse:** 12-16
(72) **Designer:** Shuichi Yamashita, Gerteisenstr 37, 70839 GERLINGEN, Tyskland (DE)
(55) **Designavbildninger:**



1.1



1.2



1.3



1.4



1.5



1.6



1.7

- (11) **Reg.nr.:** 087085
(21) **Søkn.nr.:** 20210400
(22) **Inngitt:** 2021.04.16
(24) **Løpedag:** 2021.04.16
(43) **Allm. tilgj.:** 2021.04.16
(15) **Registrert:** 2021.08.23
(45) **Kunngjort:** 2021.09.20
(18) **Reg. gjelder til:** 2026.04.16
(73) **Innehaver:** BENTE KNUITSEN, KRISTOFFER SOLEMS VEI 4, 7160 BJUGN, Norge
ST OLAVS HOSPITAL HF, Postboks 3250 Torgarden, 7006 TRONDHEIM, Norge
(50) **Anmerkninger:** Registreringen gjelder samregistrering

Design 1

- (54) **Produkt:** Grafisk symbol for bruk i pasientbehandling
(51) **Klasse:** 32-00
(72) **Designer:** BENTE KNUITSEN, KRISTOFFER SOLEMS VEI 4, 7160 BJUGN
ST OLAVS HOSPITAL HF, Postboks 3250 Torgarden, 7006 TRONDHEIM

Anmerkninger:

Supplerende undersøkelse: Ja

- (55) **Designavbildninger:**



1.1

Design 2

- (54) **Produkt:** Grafisk symbol for bruk i pasientbehandling
(51) **Klasse:** 32-00
(72) **Designer:** BENTE KNUITSEN, KRISTOFFER SOLEMS VEI 4, 7160 BJUGN
ST OLAVS HOSPITAL HF, Postboks 3250 Torgarden, 7006 TRONDHEIM

Anmerkninger:**Supplerende****undersøkelse:** Ja

- (55) **Designavbildninger:**



2.1

Design 3

- (54) **Produkt:** Grafisk symbol for bruk i pasientbehandling
(51) **Klasse:** 32-00
(72) **Designer:** BENTE KNUITSEN, KRISTOFFER SOLEMS VEI 4, 7160 BJUGN
ST OLAVS HOSPITAL HF, Postboks 3250 Torgarden, 7006 TRONDHEIM

Anmerkninger:**Supplerende****undersøkelse:** Ja

- (55) **Designavbildninger:**

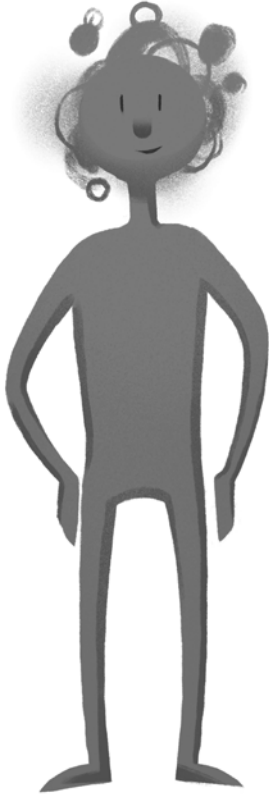

3.1

- (11) **Reg.nr.:** 087086
(21) **Søkn.nr.:** 20210517
(22) **Inngitt:** 2021.05.19
(24) **Løpedag:** 2021.05.19
(43) **Allm. tilgj.:** 2021.08.24
(15) **Registrert:** 2021.08.24
(45) **Kunngjort:** 2021.09.20
(18) **Reg. gjelder til:** 2026.05.19
(73) **Innehaver:** Dr. Ing. h.c. F. Porsche Aktiengesellschaft, Porscheplatz 1, 70435 STUTTGART, Tyskland
(74) **Fullmektig:** ACAPO AS, Postboks 1880 Nordnes, 5817 BERGEN, Norge

Design 1

- (54) **Produkt:** Felg
(51) **Klasse:** 12-16
(72) **Designer:** Shuichi Yamashita, Gerteisenstr 37, 70839 GERLINGEN, Tyskland (DE)
Emiel Burki, Rotebühstrasse 170, 10197 STUTTGART, Tyskland (DE)
(55) **Designavbildninger:**



1.1



1.2



1.3



1.4



1.5



1.6



1.7

- (11) **Reg.nr.:** 087087
(21) **Søkn.nr.:** 20210516
(22) **Inngitt:** 2021.05.19
(24) **Løpedag:** 2021.05.19
(43) **Allm. tilgj.:** 2021.08.24
(15) **Registrert:** 2021.08.24
(45) **Kunngjort:** 2021.09.20
(18) **Reg. gjelder til:** 2026.05.19
(73) **Innehaver:** Dr. Ing. h.c. F. Porsche Aktiengesellschaft, Porscheplatz 1, 70435 STUTTGART, Tyskland
(74) **Fullmektig:** ACAPO AS, Postboks 1880 Nordnes, 5817 BERGEN, Norge

Design 1

- (54) **Produkt:** Felg
(51) **Klasse:** 12-16
(72) **Designer:** Emiel Burki, Rotebühlstrasse 170, 70197 STUTTGART, Tyskland (DE)
(55) **Designavbildninger:**



1.1



1.2



1.3



1.4



1.5



1.6



1.7

- (11) **Reg.nr.:** 087088
(21) **Søkn.nr.:** 20210523
(22) **Inngitt:** 2021.05.22
(24) **Løpedag:** 2021.05.22
(43) **Allm. tilgj.:** 2021.08.24
(15) **Registrert:** 2021.08.24
(45) **Kunngjort:** 2021.09.20
(18) **Reg. gjelder til:** 2026.05.22
(73) **Innehaver:** SAFE BIL AS, Postboks 93, 1650 SELLEBAKK, Norge
SAFE LOGISTIC AS, Postboks 93, 1650 SELLEBAKK, Norge

Design 1

- (54) **Produkt:** Felg for bil, varebil og bobil
(51) **Klasse:** 12-16
(72) **Designer:** TROND AASLID, NORDSETER TERRASSE 34, 1163 OSLO
(55) **Designavbildninger:**



1.1



1.2



1.3

- (11) **Reg.nr.:** 087089
(21) **Søkn.nr.:** 20210534
(22) **Inngitt:** 2021.05.25
(24) **Løpedag:** 2021.05.25
(43) **Allm. tilgj.:** 2021.08.24
(15) **Registrert:** 2021.08.24
(45) **Kunngjort:** 2021.09.20
(18) **Reg. gjelder til:** 2026.05.25
(73) **Innehaver:** SCAN LAMPS AS, Postboks 4663, 4673 KRISTIANSAND S, Norge
(50) **Anmerkninger:** Registreringen gjelder samregistrering

Design 1

- (54) **Produkt:** Lampe
(51) **Klasse:** 26-05
(72) **Designer:** SCAN LAMPS AS, Postboks 4663, 4673 KRISTIANSAND S
(55) **Designavbildninger:**

**Design 2**

- (54) **Produkt:** Montasjebraakett for lampe
(51) **Klasse:** 26-05
(72) **Designer:** SCAN LAMPS AS, Postboks 4663, 4673 KRISTIANSAND S
(55) **Designavbildninger:**



- (11) **Reg.nr.:** 087090
- (21) **Søkn.nr.:** 20210194
- (22) **Inngitt:** 2021.02.23
- (24) **Løpedag:** 2021.02.23
- (43) **Allm. tilgj.:** 2021.02.23
- (15) **Registrert:** 2021.08.25
- (45) **Kunngjort:** 2021.09.20
- (18) **Reg. gjelder til:** 2026.02.23
- (73) **Innehaver:** FORA FORM AS, Postboks 4, 6151 ØRSTA, Norge
- (50) **Anmerkninger:** Registreringen gjelder samregistrering

Design 1

- (54) **Produkt:** Modulelement til hylle
- (51) **Klasse:** 06-04
- (72) **Designer:** STEINAR HINDENES DESIGN AS, Møllendalsveien 17, 5009 BERGEN
BERG ANDERS DESIGN AS, Møllendalsveien 17, 5009 BERGEN
- (55) **Designavbildninger:**



1.1

Design 2

- (54) **Produkt:** Modulelement til hylle
- (51) **Klasse:** 06-04
- (72) **Designer:** STEINAR HINDENES DESIGN AS, Møllendalsveien 17, 5009 BERGEN
BERG ANDERS DESIGN AS, Møllendalsveien 17, 5009 BERGEN
- (55) **Designavbildninger:**



2.1

Design 3

- (54) **Produkt:** Modulelement til hylle
(51) **Klasse:** 06-04
(72) **Designer:** STEINAR HINDENES DESIGN AS, Møllendalsveien 17, 5009 BERGEN
BERG ANDERS DESIGN AS, Møllendalsveien 17, 5009 BERGEN
(55) **Designavbildninger:**



3.1

- (11) **Reg.nr.:** 087091
(21) **Søkn.nr.:** 20210554
(22) **Inngitt:** 2021.05.28
(24) **Løpedag:** 2021.05.28
(43) **Allm. tilgj.:** 2021.08.26
(15) **Registrert:** 2021.08.26
(45) **Kunngjort:** 2021.09.20
(18) **Reg. gjelder til:** 2026.05.28
(73) **Innehaver:** Slettvoll Møbler AS, Skaffarvegen 105, 6200 STRANDA, Norge
(74) **Fullmektig:** ZACCO NORWAY AS, Postboks 488, 0213 OSLO, Norge
(50) **Anmerkninger:** Registreringen gjelder samregistrering

Design 1

- (54) **Produkt:** Stol
(51) **Klasse:** 06-01
(72) **Designer:**
(55) **Designavbildninger:**



1.1



1.2



1.3



1.4



1.5



1.6



1.7

Design 2

- (54) **Produkt:** Stol
(51) **Klasse:** 06-01
(72) **Designer:**
(55) **Designavbildninger:**



2.1



2.2



2.3



2.4



2.5



2.6



2.7

- (11) **Reg.nr.:** 087092
 (21) **Søkn.nr.:** 20210555
 (22) **Inngitt:** 2021.05.28
 (24) **Løpedag:** 2021.05.28
 (43) **Allm. tilgj.:** 2021.08.26
 (15) **Registrert:** 2021.08.26
 (45) **Kunngjort:** 2021.09.20
 (18) **Reg. gjelder til:** 2026.05.28
 (73) **Innehaver:** Slettvoll Møbler AS, Skaffarvegen 105, 6200 STRANDA, Norge
 (74) **Fullmektig:** ZACCO NORWAY AS, Postboks 488, 0213 OSLO, Norge
 (50) **Anmerkninger:** Registreringen gjelder samregistrering

Design 1

- (54) **Produkt:** Sofa
 (51) **Klasse:** 06-01
 (72) **Designer:**
 (55) **Designavbildninger:**



1.1



1.2



1.3



1.4



1.5



1.6



1.7

Design 2

- (54) **Produkt:** Sofa
 (51) **Klasse:** 06-01
 (72) **Designer:**
 (55) **Designavbildninger:**



2.1



2.2



2.3



2.4

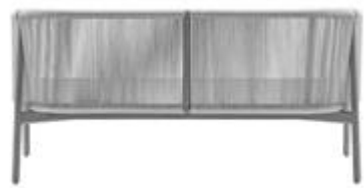

2.5



2.6



2.7

- (11) **Reg.nr.:** 087093
(21) **Søkn.nr.:** 20210153
(22) **Inngitt:** 2021.02.16
(24) **Løpedag:** 2021.02.16
(43) **Allm. tilgj.:** 2021.08.16
(15) **Registrert:** 2021.08.27
(45) **Kunngjort:** 2021.09.20
(18) **Reg. gjelder til:** 2026.02.16
(73) **Innehaver:** SCAN LAMPS AS, Postboks 4663, 4673 KRISTIANSAND S, Norge

Design 1

- (54) **Produkt:** Downlight
(51) **Klasse:** 26-05
(72) **Designer:** SCAN LAMPS AS, Postboks 4663, 4673 KRISTIANSAND S
KJETIL HANSEN, GEITERÅSEN 12, 4640 SØGNE

Anmerkninger:**Supplerende****undersøkelse:** Ja

- (55) **Designavbildninger:**



1.1



1.2



1.3

- (11) **Reg.nr.:** 087094
(21) **Søkn.nr.:** 20210536
(22) **Inngitt:** 2021.05.26
(24) **Løpedag:** 2021.05.26
(43) **Allm. tilgj.:** 2021.05.26
(15) **Registrert:** 2021.08.30
(45) **Kunngjort:** 2021.09.20
(18) **Reg. gjelder til:** 2026.05.26
(73) **Innehaver:** Dr. Vranjes Firenze S.p.A., Via Sandro Pertini, 5, Frazione Antella, 50012 BAGNO A RIPOLI (FI), Italia
(74) **Fullmektig:** BRYN AARFLOT AS, Stortingsgata 8, 0161 OSLO, Norge

Design 1

- (54) **Produkt:** Parfymeflaske.
(51) **Klasse:** 09-01
(72) **Designer:** Paolo Vranjes, Via G. D'annunzio 233, 50135 FIRENZE FI, Italia (IT)
(30) **Prioritet:** 2021.01.11, EM, 008400329, 1
(55) **Designavbildninger:**

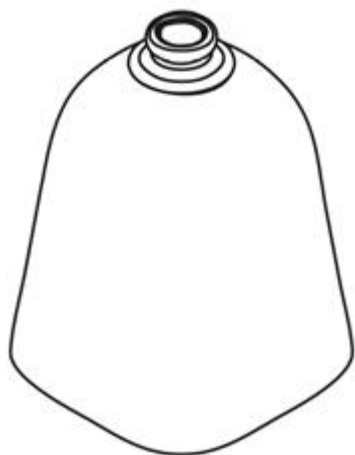

1.1

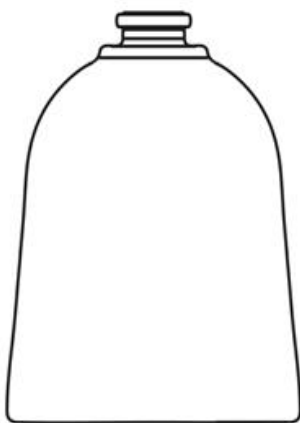

1.2

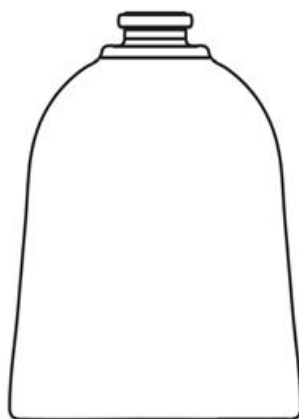

1.3

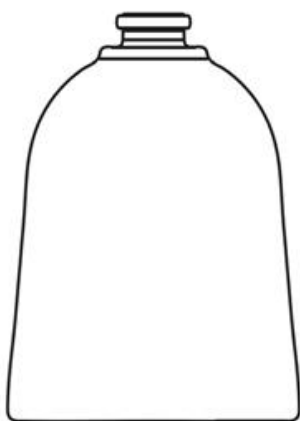

1.4

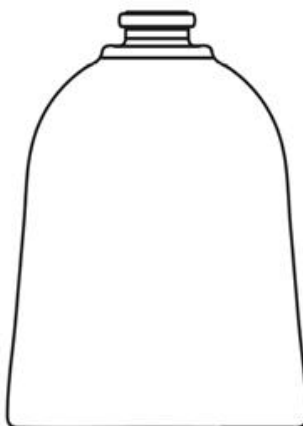

1.5

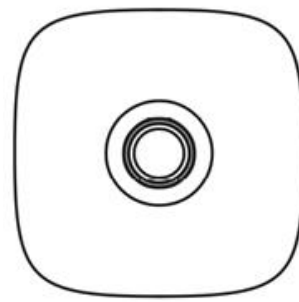

1.6

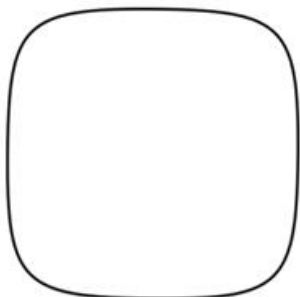

1.7

- (11) **Reg.nr.:** 087095
(21) **Søkn.nr.:** 20210344
(22) **Inngitt:** 2021.04.14
(24) **Løpedag:** 2021.04.14
(43) **Allm. tilgj.:** 2021.08.31
(15) **Registrert:** 2021.08.31
(45) **Kunngjort:** 2021.09.20
(18) **Reg. gjelder til:** 2026.04.14
(73) **Innehaver:** Beckmann AS, Buråsen 32, 4636 KRISTIANSAND S, Norge
(74) **Fullmektig:** ZACCO NORWAY AS, Postboks 488, 0213 OSLO, Norge
(50) **Anmerkninger:** Registreringen gjelder samregistrering

Design 1

- (54) **Produkt:** Ryggsekk
(51) **Klasse:** 03-01
(72) **Designer:**
(55) **Designavbildninger:**



1.1



1.2

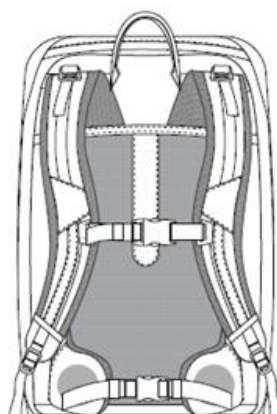

1.3

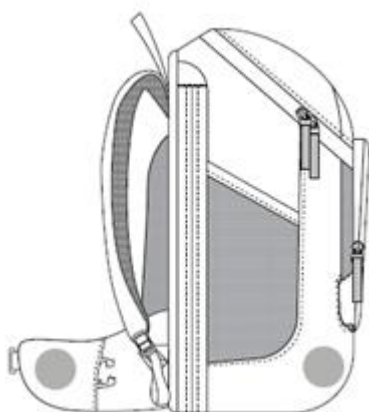

1.4

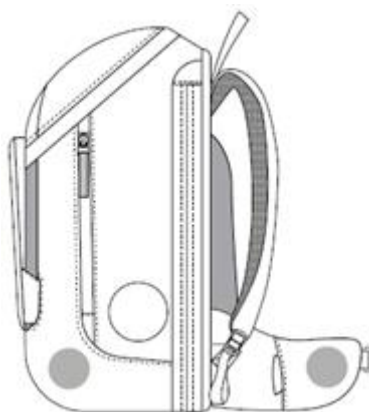

1.5



1.6



1.7

Design 2

- (54) **Produkt:** Ryggsekk
(51) **Klasse:** 03-01
(72) **Designer:**
(55) **Designavbildninger:**



2.1

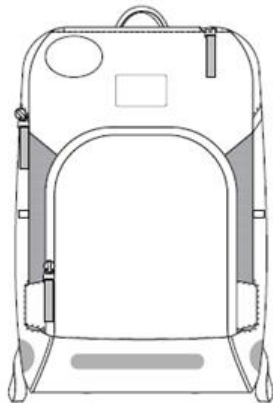

2.2

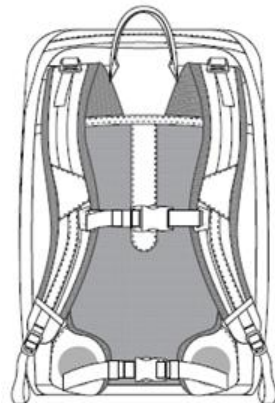

2.3

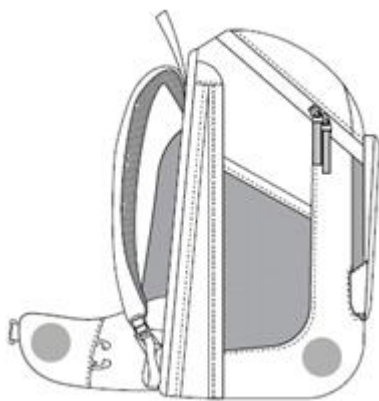

2.4



2.5



2.6



2.7

- (11) **Reg.nr.:** 087096
(21) **Søkn.nr.:** 20210539
(22) **Inngitt:** 2021.05.28
(24) **Løpedag:** 2021.05.28
(43) **Allm. tilgj.:** 2021.05.30
(15) **Registrert:** 2021.08.31
(45) **Kunngjort:** 2021.09.20
(18) **Reg. gjelder til:** 2026.05.28
(73) **Innehaver:** Caspar Cloer GmbH & Co. KG, Von-Siemens-Str. 12, 59757 ARNSBERG, Tyskland
(74) **Fullmektig:** OSLO PATENTKONTOR AS, Hoffsvaien 1A, 0275 OSLO, Norge
(50) **Anmerkninger:** Registreringen gjelder samregistrering

Design 1

- (54) **Produkt:** Vaffeljern
(51) **Klasse:** 07-02
(72) **Designer:**
(30) **Prioritet:** 2020.11.30, EM, 008303416, 1, 2, 3, 4, 5, 6
(55) **Designavbildninger:**



1.1



1.2



1.3



1.4



1.5



1.6

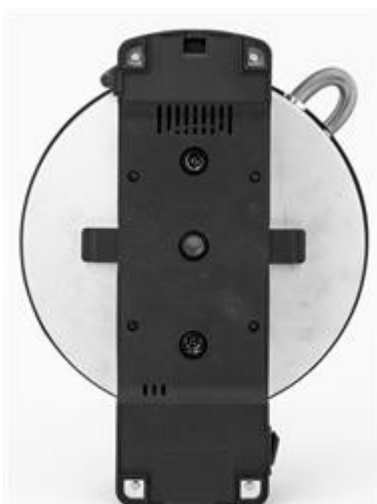

1.7

Design 2

- (54) **Produkt:** Vaffeljern
(51) **Klasse:** 07-02
(72) **Designer:**
(30) **Prioritet:** 2020.11.30, EM, 008303416, 1, 2, 3, 4, 5, 6
(55) **Designavbildninger:**



2.1



2.2



2.3



2.4



2.5



2.6



2.7

Design 3

- (54) **Produkt:** Vaffeljern
(51) **Klasse:** 07-02
(72) **Designer:**
(30) **Prioritet:** 2020.11.30, EM, 008303416, 1, 2, 3, 4, 5, 6
(55) **Designavbildninger:**



3.1



3.2



3.3



3.4



3.5



3.6

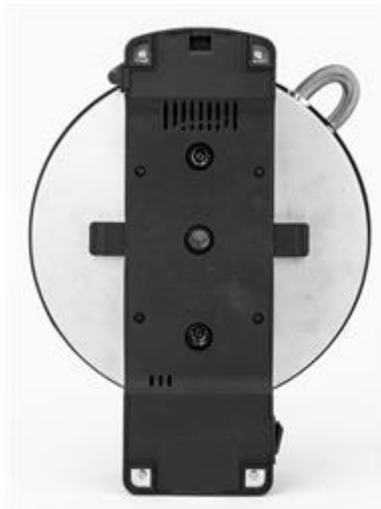

3.7

Design 4

- (54) **Produkt:** Vaffeljern
 (51) **Klasse:** 07-02
 (72) **Designer:**
 (30) **Prioritet:** 2020.11.30, EM, 008303416, 1, 2, 3, 4, 5, 6
 (55) **Designavbildninger:**



4.1



4.2



4.3



4.4



4.5



4.6



4.7

Design 5

- (54) **Produkt:** Toastjern
 (51) **Klasse:** 07-02
 (72) **Designer:**
 (30) **Prioritet:** 2020.11.30, EM, 008303416, 1, 2, 3, 4, 5, 6
Anmerkninger:
 (57) **Design i farger:** Ja
 (55) **Designavbildninger:**



5.1



5.2



5.3



5.4



5.5



5.6



5.7

Design 6

- (54) **Produkt:** Toastjern
(51) **Klasse:** 07-02
(72) **Designer:**
(30) **Prioritet:** 2020.11.30, EM, 008303416, 1, 2, 3, 4, 5, 6
Anmerkninger:
(57) **Design i farger:** Ja
(55) **Designavbildninger:**



6.1



6.2



6.3



6.4



6.5



6.6



6.7

- (11) **Reg.nr.:** 087097
(21) **Søkn.nr.:** 20210404
(22) **Inngitt:** 2021.04.19
(24) **Løpedag:** 2021.04.19
(43) **Allm. tilgj.:** 2021.04.20
(15) **Registrert:** 2021.08.31
(45) **Kunngjort:** 2021.09.20
(18) **Reg. gjelder til:** 2026.04.19
(73) **Innehaver:** Cyklos AB, Box 4, 64721 MARIEFRED, Sverige
(74) **Fullmektig:** APACE IP AS, Parkveien 55, 0256 OSLO, Norge

Design 1

- (54) **Produkt:** Sykkelskur
(51) **Klasse:** 25-03
(72) **Designer:** Cyklos AB, Box 4, 64721 MARIEFRED, Sverige (SE)
(30) **Prioritet:** 2020.10.20, EM, 008207112, 1
(55) **Designavbildninger:**



1.1



1.2

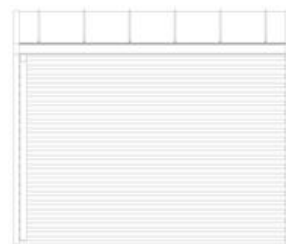

1.3

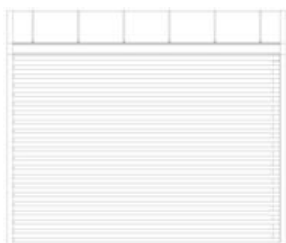

1.4



1.5



1.6



1.7

- (11) **Reg.nr.:** 087098
(21) **Søkn.nr.:** 20210405
(22) **Inngitt:** 2021.04.19
(24) **Løpedag:** 2021.04.19
(43) **Allm. tilgj.:** 2021.04.20
(15) **Registrert:** 2021.08.31
(45) **Kunngjort:** 2021.09.20
(18) **Reg. gjelder til:** 2026.04.19
(73) **Innehaver:** Cyklos AB, Box 4, 64721 MARIEFRED, Sverige
(74) **Fullmektig:** APACE IP AS, Parkveien 55, 0256 OSLO, Norge

Design 1

- (54) **Produkt:** Sykkelskur
(51) **Klasse:** 25-03
(72) **Designer:** Cyklos AB, Box 4, 64721 MARIEFRED, Sverige (SE)
(30) **Prioritet:** 2020.10.20, EM, 008207112, 1
(55) **Designavbildninger:**



1.1



1.2



1.3



1.4



1.5



1.6

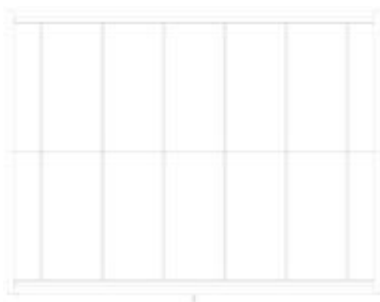

1.7

- (11) **Reg.nr.:** 087099
(21) **Søkn.nr.:** 20210345
(22) **Inngitt:** 2021.04.15
(24) **Løpedag:** 2021.04.15
(43) **Allm. tilgj.:** 2021.08.31
(15) **Registrert:** 2021.08.31
(45) **Kunngjort:** 2021.09.20
(18) **Reg. gjelder til:** 2026.04.15
(73) **Innehaver:** Apple Inc., One Apple Park Way, CA95014 CUPERTINO, USA
(74) **Fullmektig:** PROTECTOR IP AS, Pilestredet 33, 0166 OSLO, Norge

Design 1

- (54) **Produkt:** Spøringsbrikke
(51) **Klasse:** 14-03
(72) **Designer:**
Anmerkninger:
Supplerende
undersøkelse: Ja
(55) **Designavbildninger:**

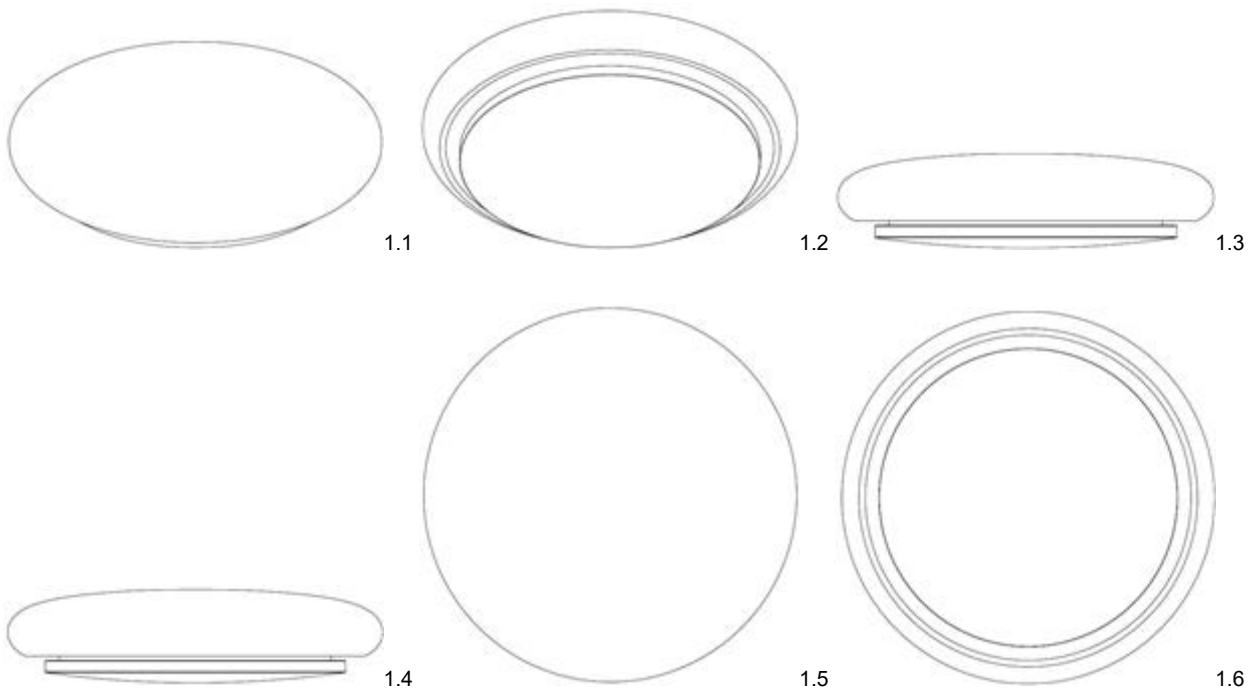

- (11) **Reg.nr.:** 087100
(21) **Søkn.nr.:** 20210179
(22) **Inngitt:** 2021.02.17
(24) **Løpedag:** 2021.02.17
(43) **Allm. tilgj.:** 2021.02.17
(15) **Registrert:** 2021.08.31
(45) **Kunngjort:** 2021.09.20
(18) **Reg. gjelder til:** 2026.02.17
(73) **Innehaver:** Apple Inc., One Apple Park Way, CA95014 CUPERTINO, USA
(74) **Fullmektig:** PROTECTOR IP AS, Pilestredet 33, 0166 OSLO, Norge

Design 1

- (54) **Produkt:** Smartklokke
(51) **Klasse:** 10-02
(72) **Designer:**
(30) **Prioritet:** 2020.08.20, US, 29/747,244, 1
Anmerkninger:
Supplerende undersøkelse: Ja
(55) **Designavbildninger:**

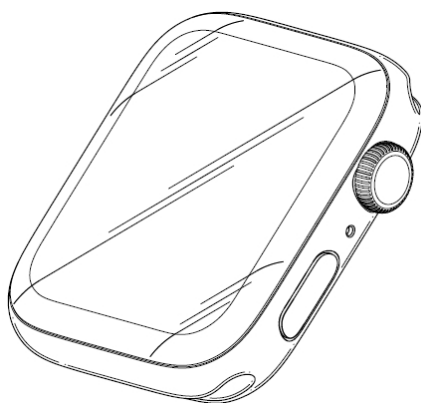

1.1



1.2



1.3

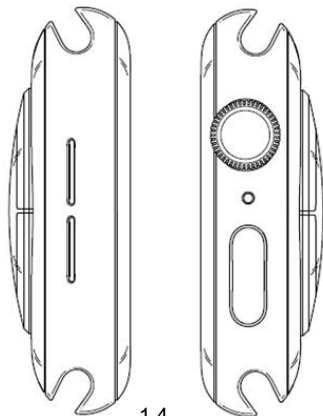

1.4

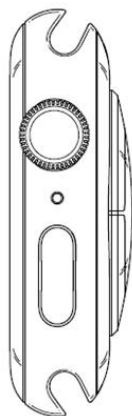

1.5



1.6



1.7

- (11) **Reg.nr.:** 087101
(21) **Søkn.nr.:** 20210342
(22) **Inngitt:** 2021.04.14
(24) **Løpedag:** 2021.04.14
(43) **Allm. tilgj.:** 2021.08.31
(15) **Registrert:** 2021.08.31
(45) **Kunngjort:** 2021.09.20
(18) **Reg. gjelder til:** 2026.04.14
(73) **Innehaver:** PERTRA AS, Stensrudveien 4C, 1474 LØRENSKOG, Norge

Design 1

- (54) **Produkt:** Profilert list for vegg og tak
(51) **Klasse:** 25-01
(72) **Designer:** PERTRA AS, Stensrudveien 4C, 1474 LØRENSKOG
TROND EKLØV, STENSRUDVEIEN 4C, 1474 LØRENSKOG

Anmerkninger:

Supplerende undersøkelse: Ja

- (55) **Designavbildninger:**

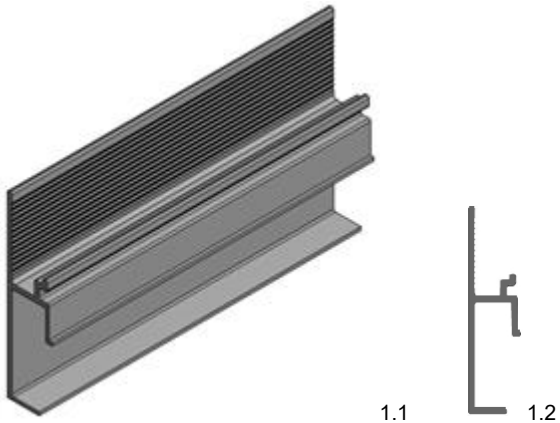

- (11) **Reg.nr.:** 087102
(21) **Søkn.nr.:** 20210776
(22) **Inngitt:** 2021.07.28
(24) **Løpedag:** 2021.07.28
(43) **Allm. tilgj.:** 2021.08.31
(15) **Registrert:** 2021.08.31
(45) **Kunngjort:** 2021.09.20
(18) **Reg. gjelder til:** 2026.07.28
(73) **Innehaver:** Hanne E Olsen Leikvoll, NESBU ALLE 42, 4052 RØYNEBERG, Norge

Design 1

- (54) **Produkt:** Adventskalender
(51) **Klasse:** 19-03
(72) **Designer:** Hanne E Olsen Leikvoll, NESBU ALLE 42, 4052 RØYNEBERG
Anmerkninger:
(57) **Design i farger:** Ja
(55) **Designavbildninger:**



1.1

- (11) **Reg.nr.:** 087103
(21) **Søkn.nr.:** 20210195
(22) **Inngitt:** 2021.02.24
(24) **Løpedag:** 2021.02.24
(43) **Allm. tilgj.:** 2021.08.24
(15) **Registrert:** 2021.09.01
(45) **Kunngjort:** 2021.09.20
(18) **Reg. gjelder til:** 2026.02.24
(73) **Innehaver:** HEYMAT PRO AS, Mellomvika 1, 8622 MO I RANA, Norge
(74) **Fullmektig:** ZIPIP AS, Herslebs gate 2B, 0561 OSLO, Norge
(50) **Anmerkninger:** Registreringen gjelder samregistrering

Design 1

- (54) **Produkt:** Gulvmatte
(51) **Klasse:** 06-11
(72) **Designer:** HEYMAT PRO AS, Mellomvika 1, 8622 MO I RANA
(55) **Designavbildninger:**

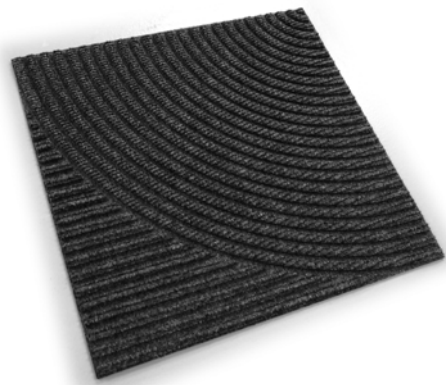

1.1



1.2

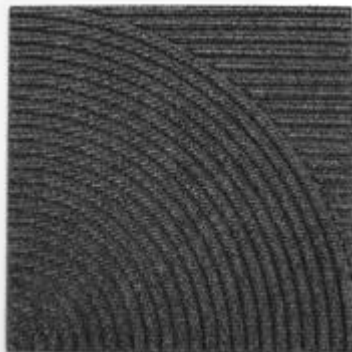

1.3



1.4

Design 2

- (54) **Produkt:** Gulvmatte
(51) **Klasse:** 06-11
(72) **Designer:** HEYMAT PRO AS, Mellomvika 1, 8622 MO I RANA
(55) **Designavbildninger:**



2.1



2.2



2.3

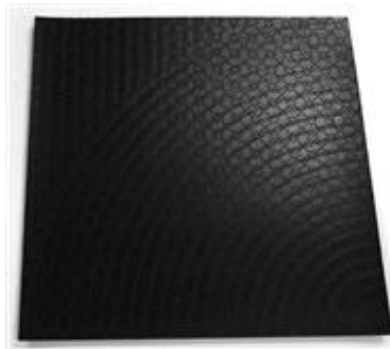

2.4

Design 3

- (54) **Produkt:** Gulvmatte
(51) **Klasse:** 06-11
(72) **Designer:** HEYMAT PRO AS, Mellomvika 1, 8622 MO I RANA
(55) **Designavbildninger:**



3.1

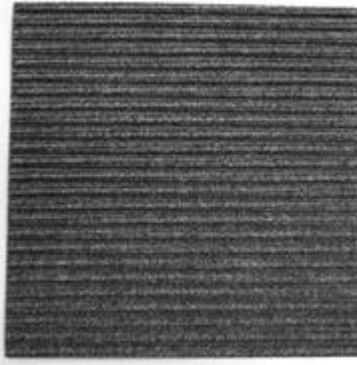

3.2

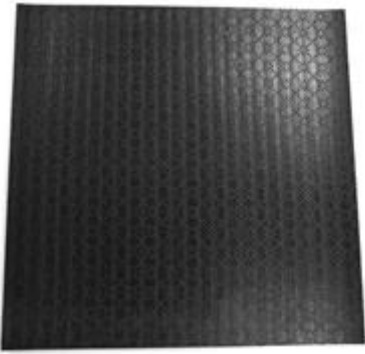

3.3

- (11) **Reg.nr.:** 087104
(21) **Søkn.nr.:** 20210316
(22) **Inngitt:** 2021.03.30
(24) **Løpedag:** 2021.03.30
(43) **Allm. tilgj.:** 2021.09.02
(15) **Registrert:** 2021.09.02
(45) **Kunngjort:** 2021.09.20
(18) **Reg. gjelder til:** 2026.03.30
(73) **Innehaver:** GEIRANGER SJOKOLADE AS, Postboks 7, 6216 GEIRANGER, Norge

Design 1

- (54) **Produkt:** Ornement
(51) **Klasse:** 32-00
(72) **Designer:** GEIRANGER SJOKOLADE AS, Postboks 7, 6216 GEIRANGER
(55) **Designavbildninger:**



1.1

- (11) **Reg.nr.:** 087105
(21) **Søkn.nr.:** 20210580
(22) **Inngitt:** 2021.06.04
(24) **Løpedag:** 2021.06.04
(43) **Allm. tilgj.:** 2021.06.30
(15) **Registrert:** 2021.09.03
(45) **Kunngjort:** 2021.09.20
(18) **Reg. gjelder til:** 2026.06.04
(73) **Innehaver:** Tentipi AB, Abmorvägen 38, 93086 MOSKOSEL, Sverige
(74) **Fullmektig:** CURO AS, Vestre Rosten 81, 7075 TILLER, Norge

Design 1

- (54) **Produkt:** Telt
(51) **Klasse:** 21-04
(72) **Designer:** Bengt Grahn, Skäggebergsvägen 7, 68630 SUNNE, Sverige (SE)
(30) **Prioritet:** 2020.12.30, EM, 008374920, 1
(55) **Designavbildninger:**

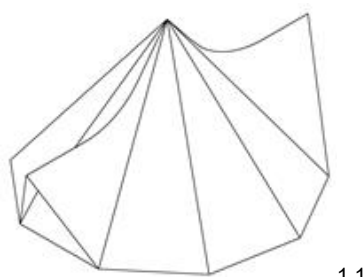

1.1

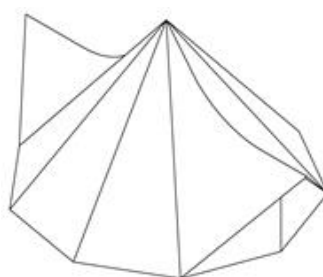

1.2

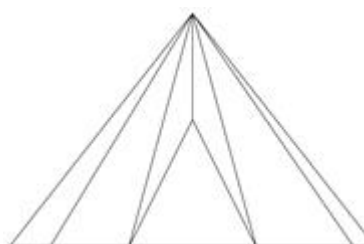

1.3

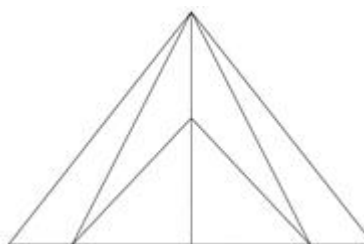

1.4

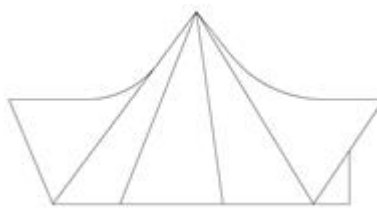

1.5



1.6

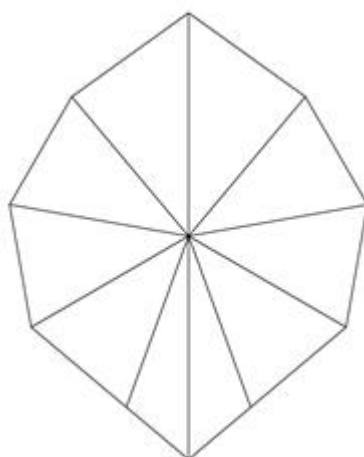

1.7

- (11) **Reg.nr.:** 087106
 (21) **Søkn.nr.:** 20210328
 (22) **Inngitt:** 2021.04.08
 (24) **Løpedag:** 2021.04.08
 (43) **Allm. tilgj.:** 2021.04.08
 (15) **Registrert:** 2021.09.03
 (45) **Kunngjort:** 2021.09.20
 (18) **Reg. gjelder til:** 2026.04.08
 (73) **Innehaver:** ENEL X S.r.l., Viale di Tor di Quinto 45/47, 00191 ROMA, Italia
 (74) **Fullmektig:** BRYN AARFLOT AS, Stortingsgata 8, 0161 OSLO, Norge
 (50) **Anmerkninger:** Registreringen gjelder samregistrering

Design 1

- (54) **Produkt:** Ladestasjon
 (51) **Klasse:** 13-02
 (72) **Designer:** Tiziano Valentineti, c/o ENEL X S.r.l. Viale di Tor di Quinto 45/47, 00191 ROMA, Italia (IT)
 (30) **Prioritet:** 2020.10.08, EM, 008197933-0002, 1, 2, 3
 (55) **Designavbildninger:**

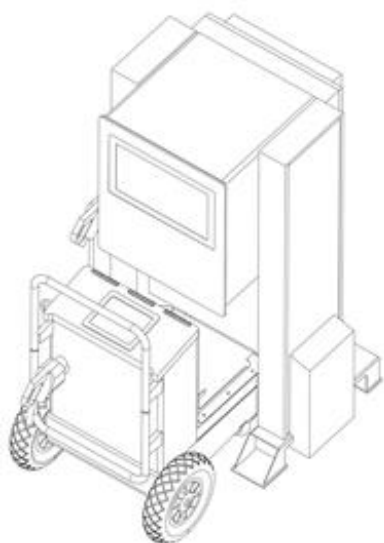

1.1

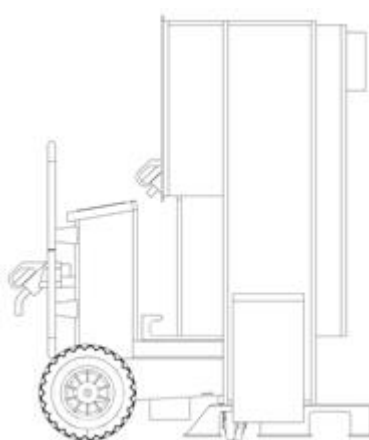

1.2

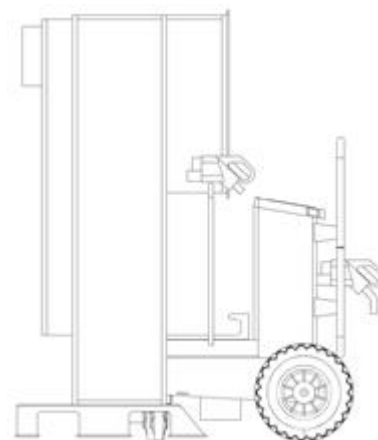

1.3

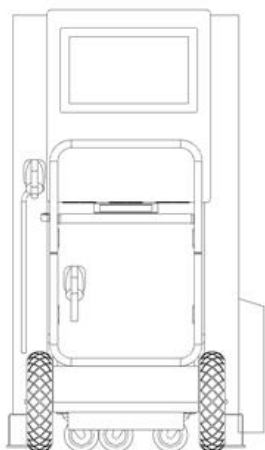

1.4

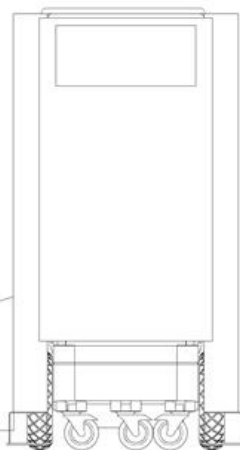

1.5

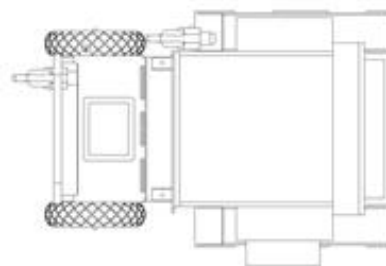

1.6

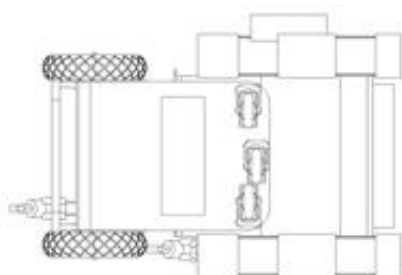

1.7

Design 2

- (54) **Produkt:** Ladestasjon
(51) **Klasse:** 13-02
(72) **Designer:** Tiziano Valentineti, c/o ENEL X S.r.l. Viale di Tor di Quinto 45/47, 00191 ROMA, Italia (IT)
(30) **Prioritet:** 2020.10.08, EM, 008197933-0002, 1, 2, 3
(55) **Designavbildninger:**



2.1

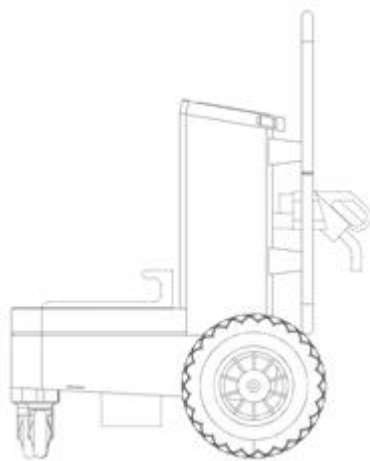

2.2

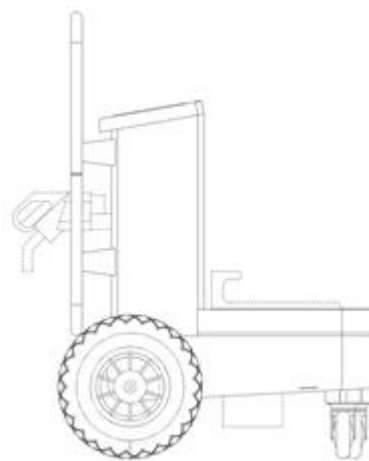

2.3

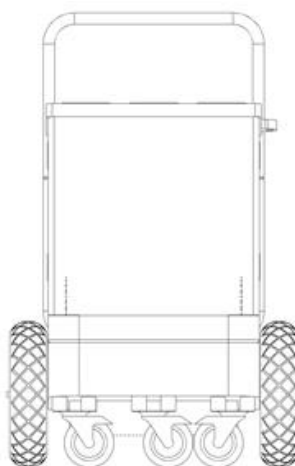

2.4

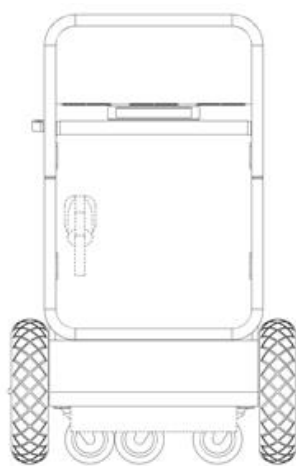

2.5

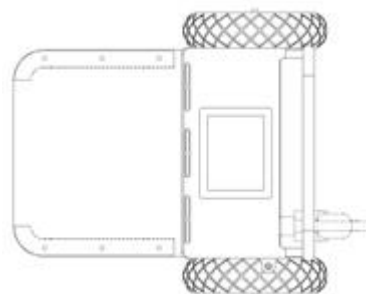

2.6

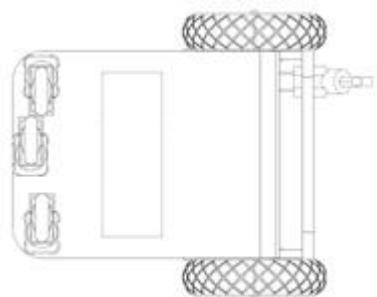

2.7

Design 3

- (54) **Produkt:** Ladestasjon
(51) **Klasse:** 13-02
(72) **Designer:** Tiziano Valentineti, c/o ENEL X S.r.l. Viale di Tor di Quinto 45/47, 00191 ROMA, Italia (IT)
(30) **Prioritet:** 2020.10.08, EM, 008197933-0002, 1, 2, 3
(55) **Designavbildninger:**

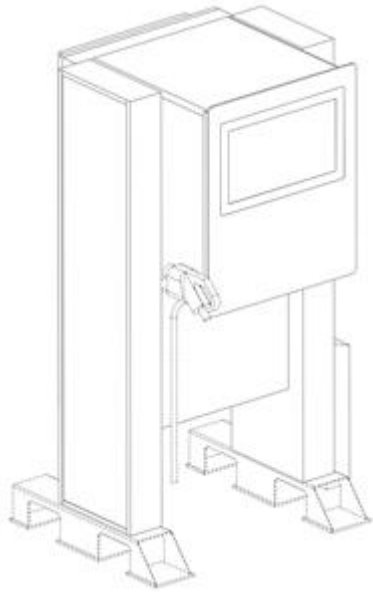

3.1

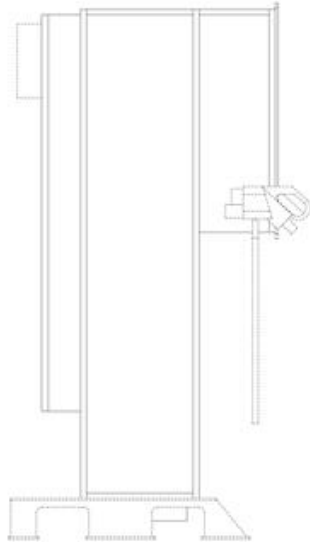

3.2

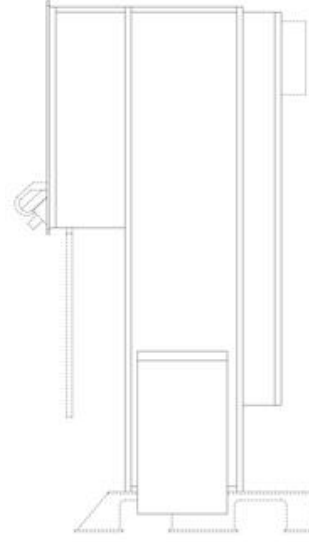

3.3

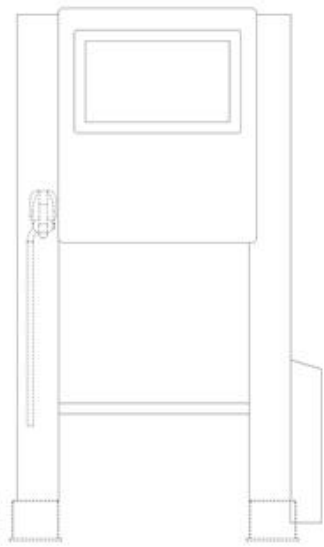

3.4

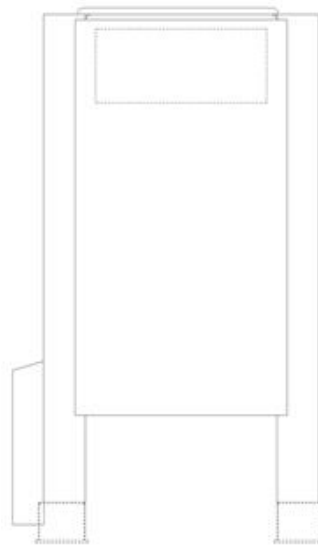

3.5

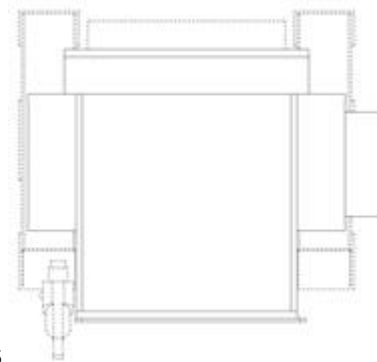

3.6

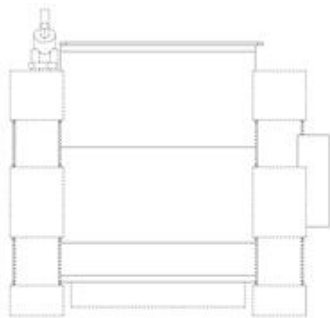

3.7

Internasjonale designregistreringer

I henhold til designloven § 57 fjerde ledd, kunngjøres i dag følgende internasjonale registreringer som har virkning i Norge.

Det kan fremsettes krav om at designregistreringen helt eller delvis skal oppheves, jf. designloven §§ 58 fjerde ledd og 25 flg. og designforskriften §§ 26 flg.

Virkingen av en internasjonal registrering gjelder for den eller de periodene på fem år som søknaden er innlevert for, regnet fra den dagen registreringen ved det Internasjonale byrået anses å ha skjedd. Registreringen kan fornyes etter bestemmelsene i Genèveavtalen, se dl § 58 tredje ledd. Maksimal beskyttelsestid er 25 år.

(11)	Reg.nr.:	DM/212794
(21)	Søkn.nr.:	20210267
(22)	Inngitt i WIPO:	2021.02.09
(15)	Registrert i WIPO:	2021.02.09
(24)	Løpedag:	2021.02.09
(43)	Allm. tilgj.:	2021.08.13
(15)	Besluttet gjeldende NO:	2021.09.01
(45)	Kunngjort NO:	2021.09.20
(18)	Reg. gjelder til:	2026.02.09
(73)	Innehaver:	Niko Group nv, Industriepark West 40, 9100 SINT-NIKLAAS, Belgia
(50)	Anmerkninger:	Registreringen gjelder samregistrering

Design 1

(54)	Produkt:	Movement sensor
(51)	Klasse:	10-05
(72)	Designer:	Arne Desmet, Industriepark West 40, 9100 SINT-NIKLAAS, Belgia (BE)
(30)	Prioritet:	2021.02.09, EM, 008430920, 1, 2
(55)	Designavbildninger:	



1.1



1.2



1.3



1.4

Design 2

(54) **Produkt:** Movement sensor
(51) **Klasse:** 10-05
(72) **Designer:** Arne Desmet, Industriepark West 40, 9100 SINT-NIKLAAS, Belgia (BE)
(30) **Prioritet:** 2021.02.09, EM, 008430920, 1, 2
(55) **Designavbildninger:**



2.1



2.2

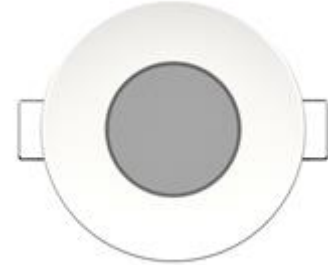

2.3



2.4

(11)	Reg.nr.:	DM/212952
(21)	Søkn.nr.:	20210357
(22)	Inngitt i WIPO:	2021.02.26
(15)	Registrert i WIPO:	2021.02.26
(24)	Løpedag:	2021.02.26
(43)	Allm. tilgj.:	2021.08.27
(15)	Besluttet gjeldende NO:	2021.08.31
(45)	Kunngjort NO:	2021.09.20
(18)	Reg. gjelder til:	2026.02.26
(73)	Innehaver:	Pi-Design AG, Kantonsstrasse 100, 6234 TRIENGEN, Sveits
(50)	Anmerkninger:	Registreringen gjelder samregistrering

Design 1

(54)	Produkt:	Carafe
(51)	Klasse:	07-01
(72)	Designer:	Jorgen BODUM, Käppelistrasse 15, 6045 MEGGEN, Sveits (CH)
(55)	Designavbildninger:	

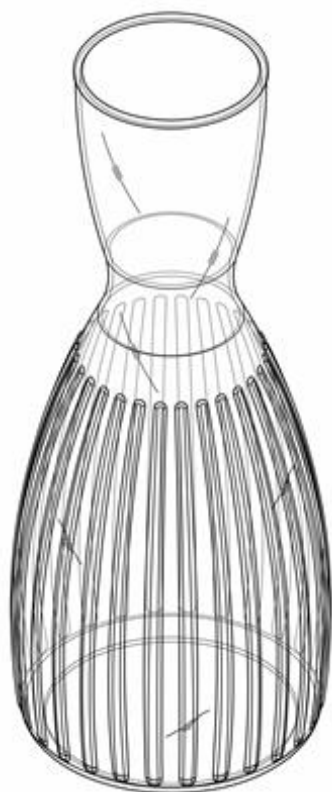

1.1

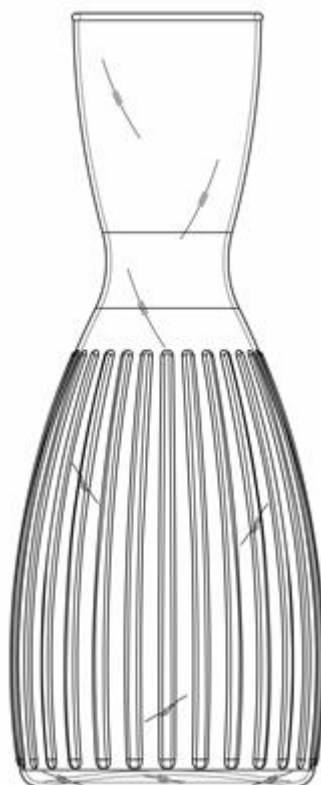

1.2

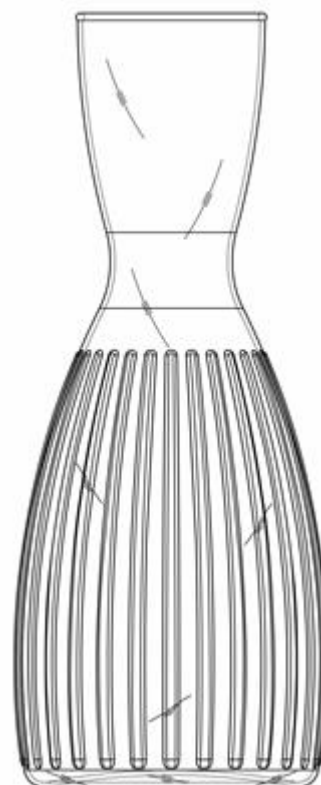

1.3

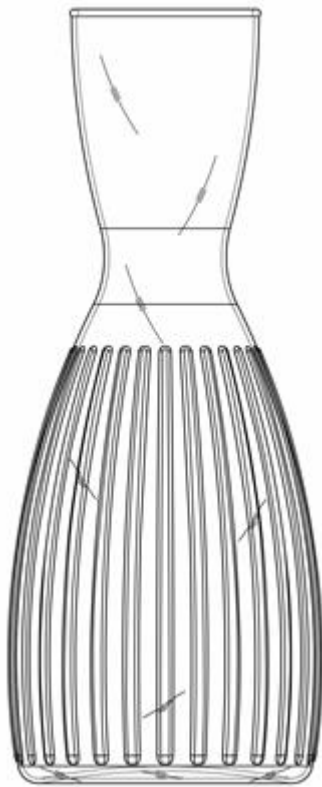

1.4

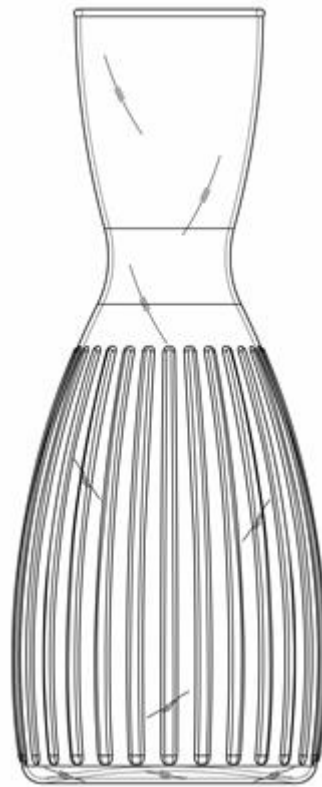

1.5

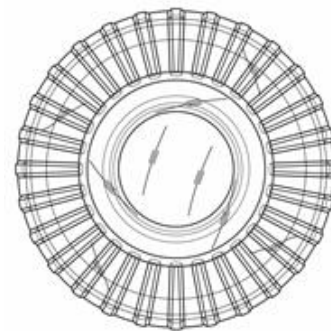

1.6

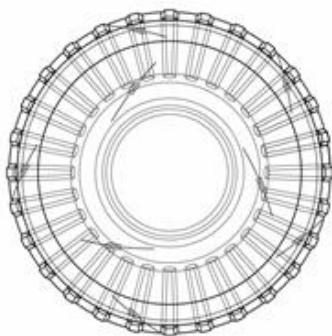

1.7

Design 2

- (54) **Produkt:** Carafe
(51) **Klasse:** 07-01
(72) **Designer:** Jorgen BODUM, Käppelistrasse 15, 6045 MEGGEN, Sveits (CH)
(55) **Designavbildninger:**

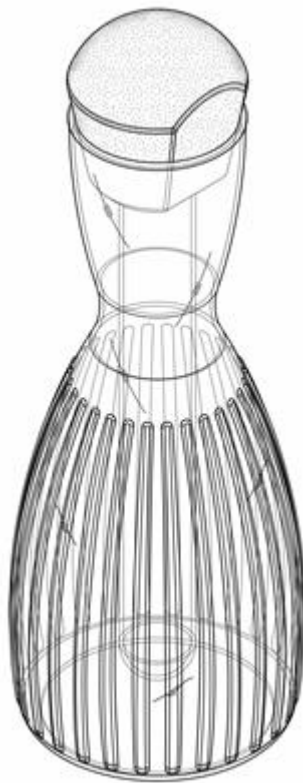

2.1

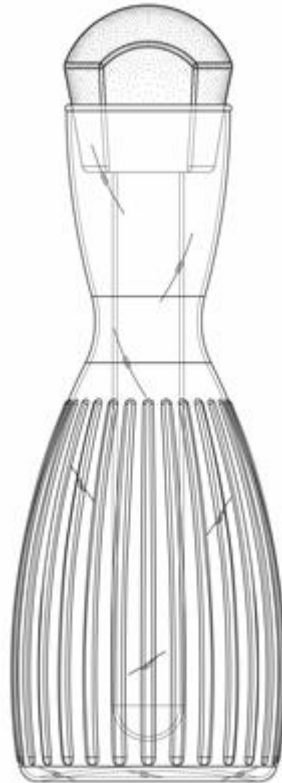

2.2

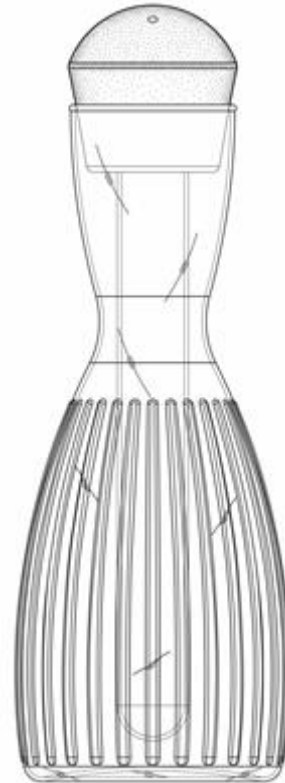

2.3

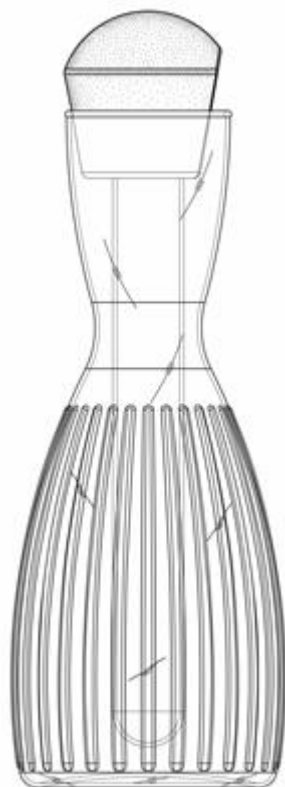

2.4

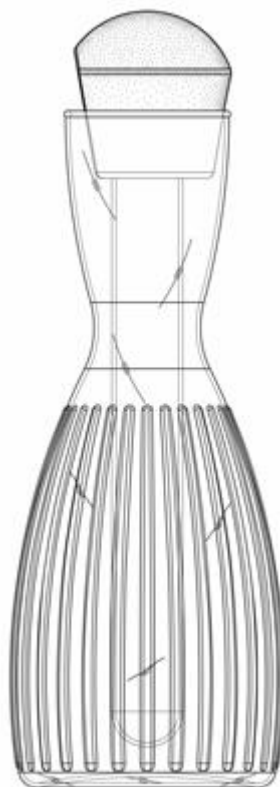

2.5

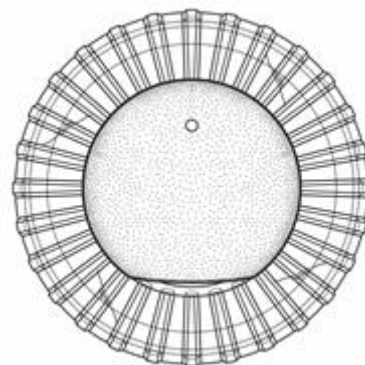

2.6

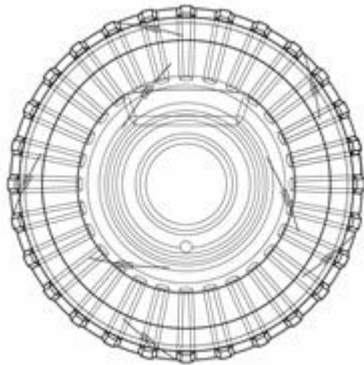

2.7

Design 3(54) **Produkt:**

Carafe

(51) **Klasse:**

07-01

(72) **Designer:**

Jorgen BODUM, Käppelistrasse 15, 6045 MEGGEN, Sveits (CH)

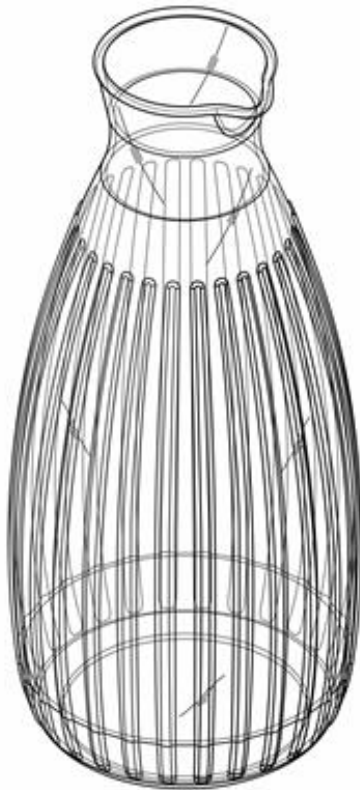
(55) **Designavbildninger:**

3.1

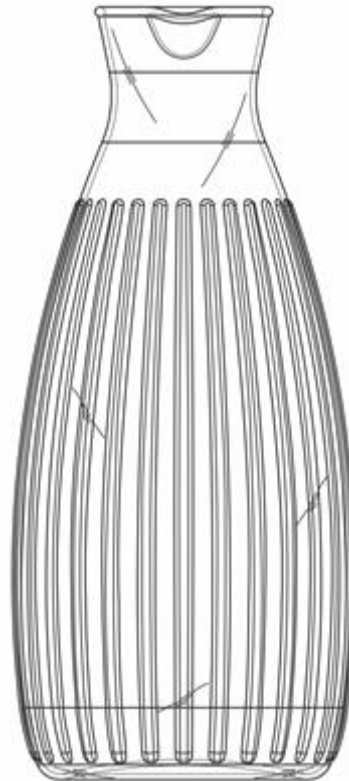

3.2

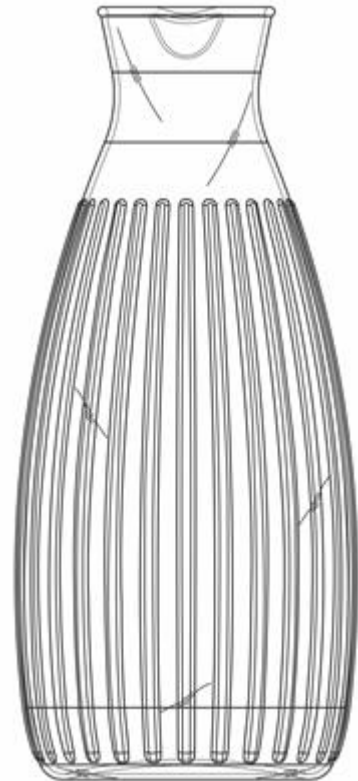

3.3

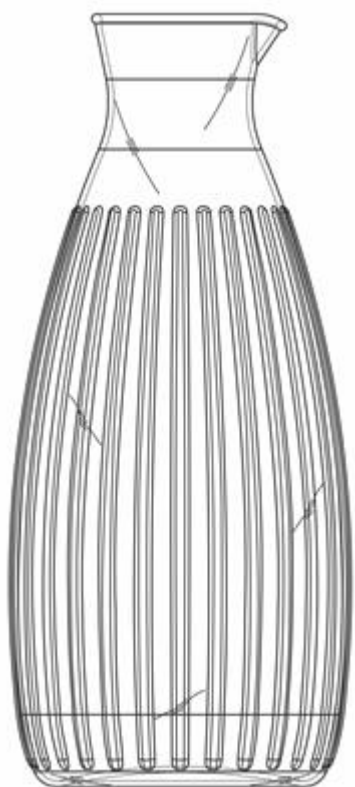

3.4

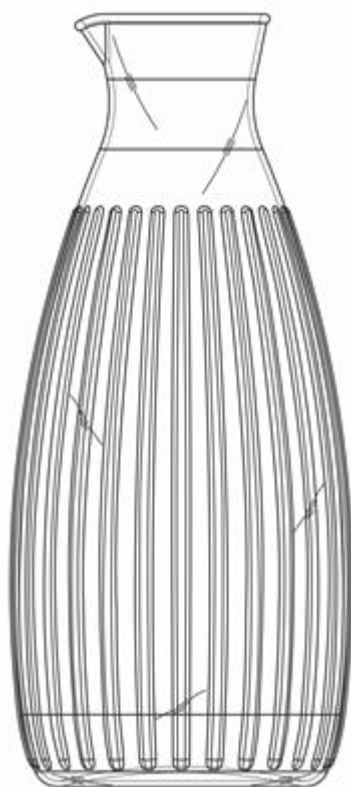

3.5

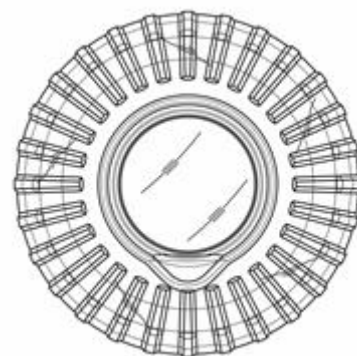

3.6

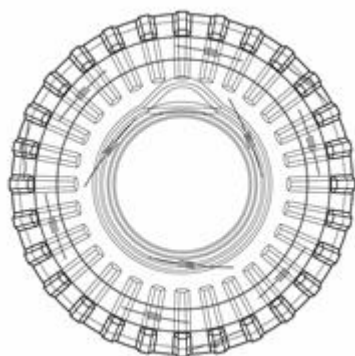

3.7

(11)	Reg.nr.:	DM/212953
(21)	Søkn.nr.:	20210358
(22)	Inngitt i WIPO:	2021.02.25
(15)	Registrert i WIPO:	2021.02.25
(24)	Løpedag:	2021.02.25
(43)	Allm. tilgj.:	2021.08.27
(15)	Besluttet gjeldende NO:	2021.08.31
(45)	Kunngjort NO:	2021.09.20
(18)	Reg. gjelder til:	2026.02.25
(73)	Innehaver:	Pi-Design AG, Kantonsstrasse 100, 6234 TRIENGEN, Sveits
(50)	Anmerkninger:	Registreringen gjelder samregistrering

Design 1

(54)	Produkt:	Tumbler
(51)	Klasse:	07-01
(72)	Designer:	Jorgen BODUM, Käppelistrasse 15, 6045 MEGGEN, Sveits (CH)
(55)	Designavbildninger:	

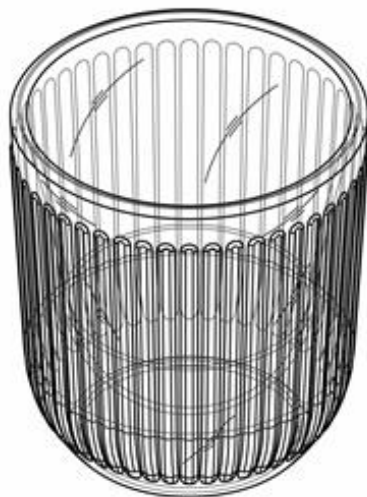

1.1

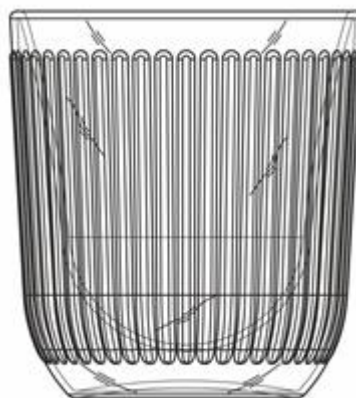

1.2

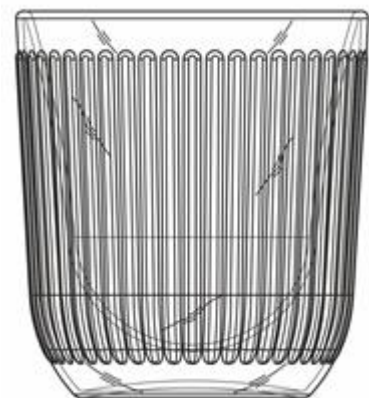

1.3



1.4

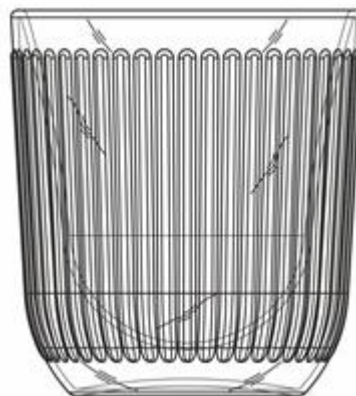

1.5

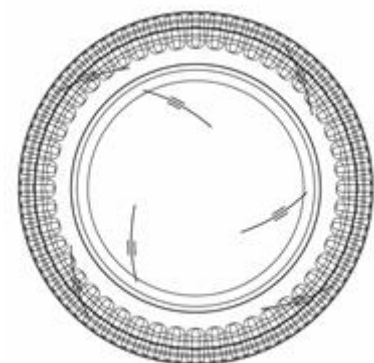

1.6

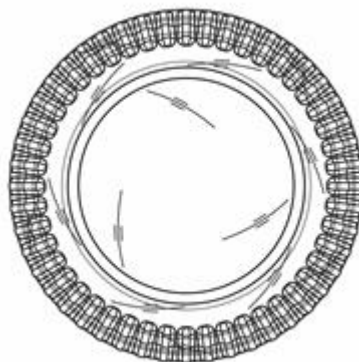

1.7

Design 2

- (54) **Produkt:** Tumbler
(51) **Klasse:** 07-01
(72) **Designer:** Jorgen BODUM, Käppelistrasse 15, 6045 MEGGEN, Sveits (CH)
(55) **Designavbildninger:**

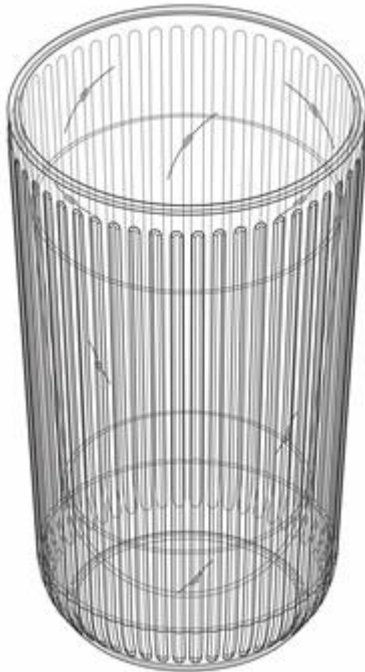

2.1



2.2



2.3



2.4



2.5

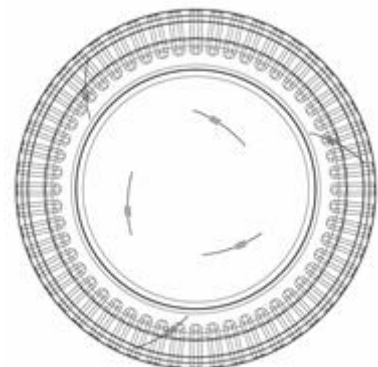

2.6

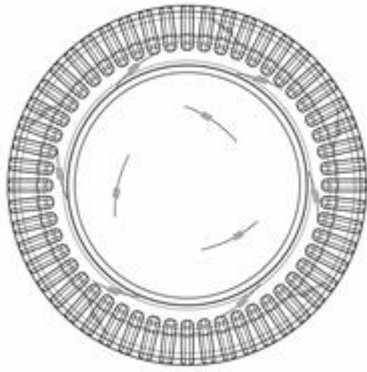

2.7

Design 3

- (54) **Produkt:** Tumbler
(51) **Klasse:** 07-01
(72) **Designer:** Jorgen BODUM, Käppelistrasse 15, 6045 MEGGEN, Sveits (CH)
(55) **Designavbildninger:**

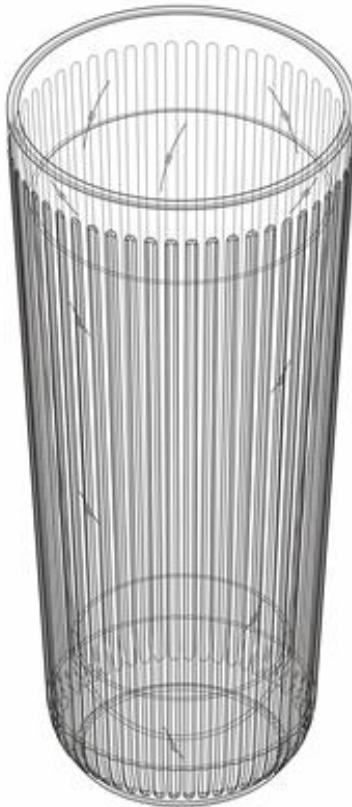

3.1

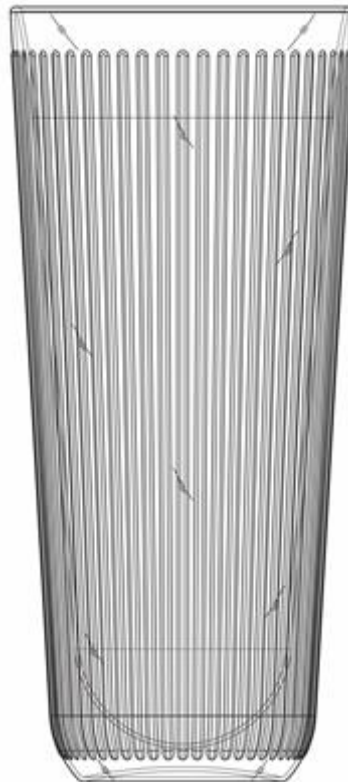

3.2

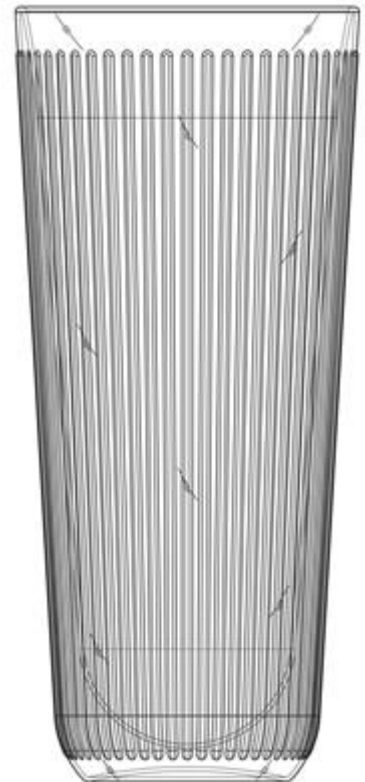

3.3

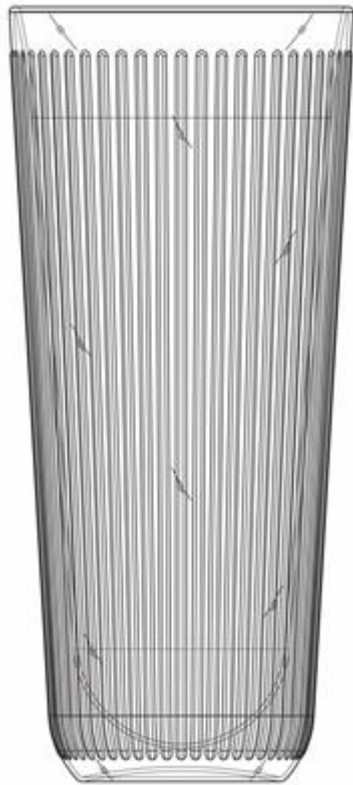

3.4

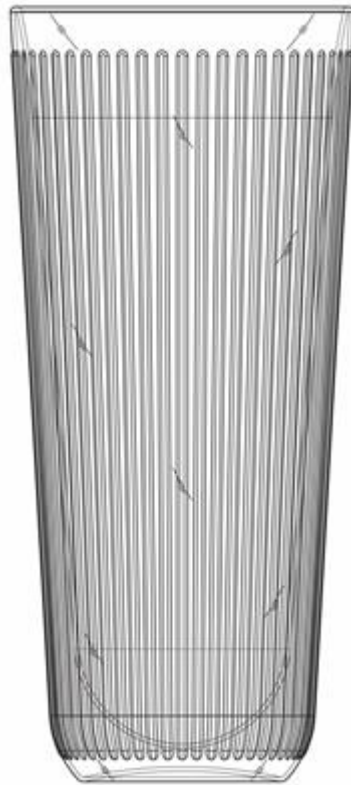

3.5

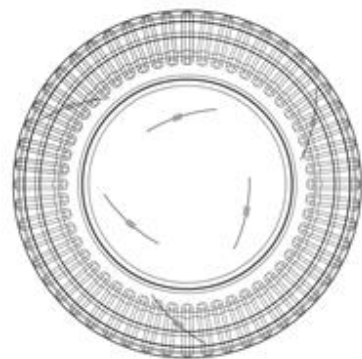

3.6

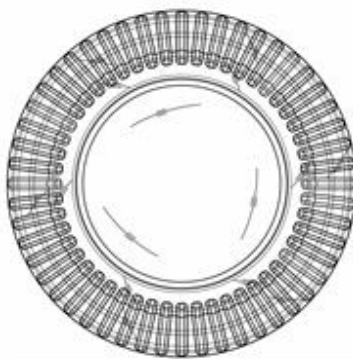

3.7

(11)	Reg.nr.:	DM/212967
(21)	Søkn.nr.:	20210360
(22)	Inngitt i WIPO:	2021.02.25
(15)	Registrert i WIPO:	2021.02.25
(24)	Løpedag:	2021.02.25
(43)	Allm. tilgj.:	2021.08.27
(15)	Besluttet gjeldende NO:	2021.08.31
(45)	Kunngjort NO:	2021.09.20
(18)	Reg. gjelder til:	2026.02.25
(73)	Innehaver:	Swatch AG (Swatch SA) (Swatch Ltd.), Nicolas G. Hayek Strasse 1, 2502 BIEL/BIENNE, Sveits

Design 1

(54)	Produkt:	Wrist watch
(51)	Klasse:	10-02
(72)	Designer:	Maxime Zenderoudi, Henric-Petri Strasse 11, 4051 BASEL, Sveits (CH)
(55)	Designavbildninger:	



1.1



1.2



1.3

(11)	Reg.nr.:	DM/212976
(21)	Søkn.nr.:	20210361
(22)	Inngitt i WIPO:	2021.02.24
(15)	Registrert i WIPO:	2021.02.24
(24)	Løpedag:	2021.02.24
(43)	Allm. tilgj.:	2021.08.27
(15)	Besluttet gjeldende NO:	2021.08.31
(45)	Kunngjort NO:	2021.09.20
(18)	Reg. gjelder til:	2026.02.24
(73)	Innehaver:	Montres Jaquet Droz SA (Montres Jaquet Droz AG) (Montres Jaquet Droz Ltd), Allée du Tourbillon 2, 2300 LA CHAUX-DE-FONDS, Sveits
(50)	Anmerkninger:	Registreringen gjelder samregistrering

Design 1

(54)	Produkt:	Watch dial
(51)	Klasse:	10-07
(72)	Designer:	Christian Lattmann, Chemin de Château-Neuf 17, 1125 MONNAZ, Sveits (CH) Yann Leiggener, La Recorne 54, 2300 LA-CHAUX-DE-FONDS, Sveits (CH)
(55)	Designavbildninger:	



1.1



1.2



1.3

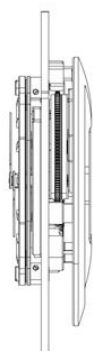

1.4



1.5



1.6



1.7

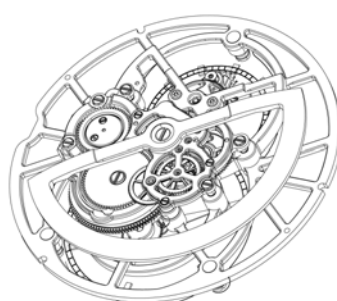

1.8

Design 2

- (54) **Produkt:** Watch dial
- (51) **Klasse:** 10-07
- (72) **Designer:** Christian Lattmann, Chemin de Château-Neuf 17, 1125 MONNAZ, Sveits (CH)
Yann Leiggener, La Recorne 54, 2300 LA-CHAUX-DE-FONDS, Sveits (CH)
- (55) **Designavbildninger:**



2.1



2.2



2.3

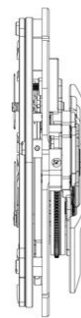

2.4



2.5



2.6



2.7

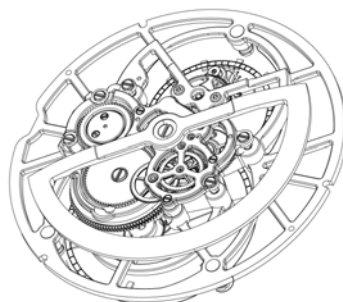

2.8

Design 3

- (54) **Produkt:** Watch dial
- (51) **Klasse:** 10-07
- (72) **Designer:** Christian Lattmann, Chemin de Château-Neuf 17, 1125 MONNAZ, Sveits (CH)
Yann Leiggener, La Recorne 54, 2300 LA-CHAUX-DE-FONDS, Sveits (CH)
- (55) **Designavbildninger:**



3.1



3.2

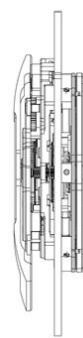

3.3



3.4



3.5



3.6



3.7



3.8

Design 4

- (54) **Produkt:** Watch dial
(51) **Klasse:** 10-07
(72) **Designer:** Christian Lattmann, Chemin de Château-Neuf 17, 1125 MONNAZ, Sveits (CH)
John Howe, Rue de Port-Roulant 20, 2000 NEUCHÂTEL, Sveits (CH)
(55) **Designavbildninger:**



4.1



4.2



4.3

(11)	Reg.nr.:	DM/213026
(21)	Søkn.nr.:	20210364
(22)	Inngitt i WIPO:	2021.02.25
(15)	Registrert i WIPO:	2021.02.25
(24)	Løpedag:	2021.02.25
(43)	Allm. tilgj.:	2021.08.27
(15)	Besluttet gjeldende NO:	2021.08.31
(45)	Kunngjort NO:	2021.09.20
(18)	Reg. gjelder til:	2026.02.25
(73)	Innehaver:	Caneias ANS, Holteveien 11, 1410 KOLBOTN, Norge

Design 1

(54)	Produkt:	Snow fence [for roofs]
(51)	Klasse:	25-02
(72)	Designer:	
(55)	Designavbildninger:	

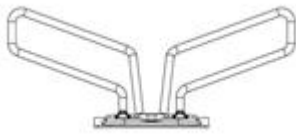

1.1



1.2



1.3

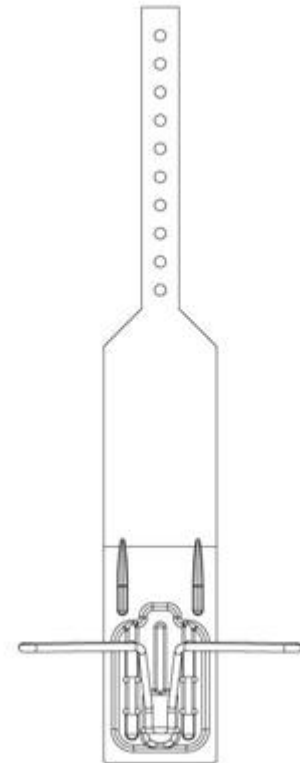

1.4



1.5

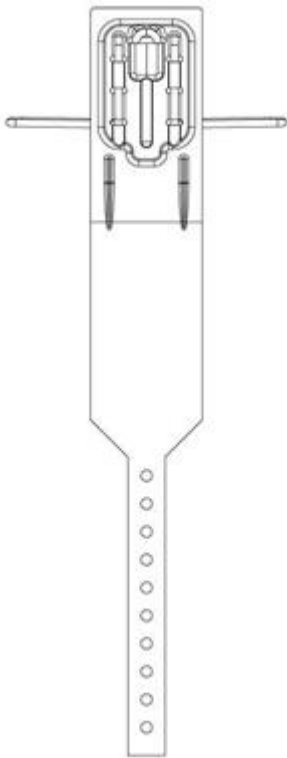

1.6

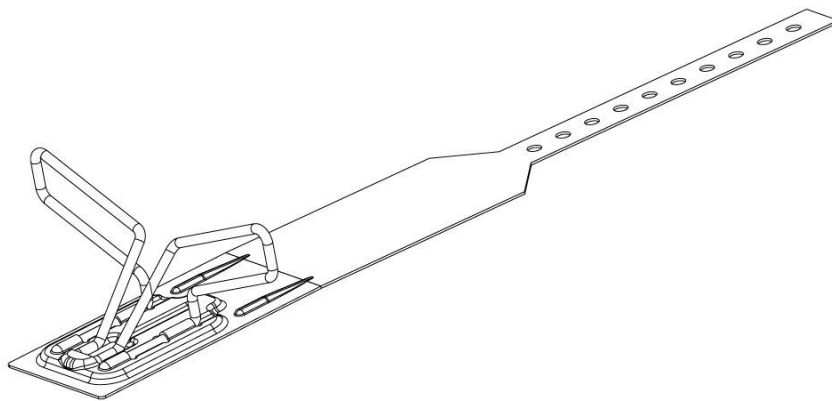

1.7

(11)	Reg.nr.:	DM/213366
(21)	Søkn.nr.:	20210392
(22)	Inngitt i WIPO:	2021.02.26
(15)	Registrert i WIPO:	2021.02.26
(24)	Løpedag:	2021.02.26
(43)	Allm. tilgj.:	2021.08.27
(15)	Besluttet gjeldende NO:	2021.08.31
(45)	Kunngjort NO:	2021.09.20
(18)	Reg. gjelder til:	2026.02.26
(73)	Innehaver:	Rautureau Apple Shoes, 2 rue des Boutons d'Or, 85130 LA GAUBRETIERE, Frankrike
(50)	Anmerkninger:	Registreringen gjelder samregistrering

Design 1

(54)	Produkt:	Shoe
(51)	Klasse:	02-04
(72)	Designer:	Alfredo CASADEI, Flat 6, 23 Frith Street, W1D4RR LONDRES, Storbritannia (GB)
(55)	Designavbildninger:	



1.1



1.2



1.3

Design 2

(54)	Produkt:	Shoe
(51)	Klasse:	02-04
(72)	Designer:	Alfredo CASADEI, Flat 6, 23 Frith Street, W1D4RR LONDRES, Storbritannia (GB)
(55)	Designavbildninger:	



2.1



2.2



2.3



2.4

Design 3

- (54) **Produkt:** Shoe
(51) **Klasse:** 02-04
(72) **Designer:** Alfredo CASADEI, Flat 6, 23 Frith Street, W1D4RR LONDRES, Storbritannia (GB)
(55) **Designavbildninger:**



3.1



3.2



3.3

Design 4

- (54) **Produkt:** Shoe
(51) **Klasse:** 02-04
(72) **Designer:** Alfredo CASADEI, Flat 6, 23 Frith Street, W1D4RR LONDRES, Storbritannia (GB)
(55) **Designavbildninger:**



4.1



4.2



4.3

Design 5

- (54) **Produkt:** Shoe
(51) **Klasse:** 02-04
(72) **Designer:** Alfredo CASADEI, Flat 6, 23 Frith Street, W1D4RR LONDRES, Storbritannia (GB)
(55) **Designavbildninger:**



5.1



5.2



5.3

Design 6

(54) **Produkt:** Shoe
(51) **Klasse:** 02-04
(72) **Designer:** Alfredo CASADEI, Flat 6, 23 Frith Street, W1D4RR LONDRES, Storbritannia (GB)
(55) **Designavbildninger:**



6.1



6.2



6.3



6.4

Design 7

(54) **Produkt:** Shoe
(51) **Klasse:** 02-04
(72) **Designer:** Alfredo CASADEI, Flat 6, 23 Frith Street, W1D4RR LONDRES, Storbritannia (GB)
(55) **Designavbildninger:**



7.1



7.2



7.3

Design 8

- (54) **Produkt:** Shoe
(51) **Klasse:** 02-04
(72) **Designer:** Alfredo CASADEI, Flat 6, 23 Frith Street, W1D4RR LONDRES, Storbritannia (GB)
(55) **Designavbildninger:**



8.1



8.2



8.3

Design 9

- (54) **Produkt:** Shoe
(51) **Klasse:** 02-04
(72) **Designer:** Alfredo CASADEI, Flat 6, 23 Frith Street, W1D4RR LONDRES, Storbritannia (GB)
(55) **Designavbildninger:**



9.1



9.2



9.3



9.4

Design 10

- (54) **Produkt:** Shoe
(51) **Klasse:** 02-04
(72) **Designer:** Alfredo CASADEI, Flat 6, 23 Frith Street, W1D4RR LONDRES, Storbritannia (GB)
(55) **Designavbildninger:**



10.1

Design 11

- (54) **Produkt:** Shoe
(51) **Klasse:** 02-04
(72) **Designer:** Alfredo CASADEI, Flat 6, 23 Frith Street, W1D4RR LONDRES, Storbritannia (GB)
(55) **Designavbildninger:**



11.1

Design 12

- (54) **Produkt:** Shoe
(51) **Klasse:** 02-04
(72) **Designer:** Alfredo CASADEI, Flat 6, 23 Frith Street, W1D4RR LONDRES, Storbritannia (GB)
(55) **Designavbildninger:**



12.1

Design 13

- (54) **Produkt:** Shoe
(51) **Klasse:** 02-04
(72) **Designer:** Alfredo CASADEI, Flat 6, 23 Frith Street, W1D4RR LONDRES, Storbritannia (GB)
(55) **Designavbildninger:**



13.1



13.2



13.3

Design 14

- (54) **Produkt:** Shoe
(51) **Klasse:** 02-04
(72) **Designer:** Alfredo CASADEI, Flat 6, 23 Frith Street, W1D4RR LONDRES, Storbritannia (GB)
(55) **Designavbildninger:**



14.1



14.2



14.3

(11) Reg.nr.:	DM/213401
(21) Søkn.nr.:	20210394
(22) Inngitt i WIPO:	2021.02.25
(15) Registrert i WIPO:	2021.02.25
(24) Løpedag:	2021.02.25
(43) Allm. tilgj.:	2021.08.27
(15) Besluttet gjeldende NO:	2021.08.31
(45) Kunngjort NO:	2021.09.20
(18) Reg. gjelder til:	2026.02.25
(73) Innehaver:	Daimler AG, Mercedesstrasse 120, 70372 STUTTGART, Tyskland
(50) Anmerkninger:	Registreringen gjelder samregistrering

Design 1

(54) Produkt:	Wheel for a vehicle
(51) Klasse:	12-16
(72) Designer:	Bernhard Hans, c/o Daimler Brand & IP Management GmbH & Co. KG, 70546 STUTTGART, Tyskland (DE) Csaba Wittinger, c/o Daimler Brand & IP Management GmbH & Co. KG, 70546 STUTTGART, Tyskland (DE)
(30) Prioritet:	2020.08.27, DE, 402020202929.0, 1, 2
(55) Designavbildninger:	



1.1



1.2

Design 2

(54) Produkt:	Wheel for a vehicle
(51) Klasse:	12-16
(72) Designer:	Bernhard Hans, c/o Daimler Brand & IP Management GmbH & Co. KG, 70546 STUTTGART, Tyskland (DE) Markus Wachter, c/o Daimler Brand & IP Management GmbH & Co. KG, 70546 STUTTGART, Tyskland (DE)
(30) Prioritet:	2020.08.27, DE, 402020202929.0, 1, 2
(55) Designavbildninger:	



2.1



2.2

(11)	Reg.nr.:	DM/214073
(21)	Søkn.nr.:	20210604
(22)	Inngitt i WIPO:	2021.02.11
(15)	Registrert i WIPO:	2021.02.11
(24)	Løpedag:	2021.02.11
(43)	Allm. tilgj.:	2021.08.13
(15)	Besluttet gjeldende NO:	2021.09.01
(45)	Kunngjort NO:	2021.09.20
(18)	Reg. gjelder til:	2026.02.11
(73)	Innehaver:	Abbott Diabetes Care, Inc., 1420 Harbor Bay Parkway, CA94502 ALAMEDA, USA

Design 1

(54)	Produkt:	Icon [for computers]
(51)	Klasse:	14-04
(72)	Designer:	P. Ashwin Kumar, 6451-B Benvenue Ave, CA94618 OAKLAND, USA (US) Pooja Hebbale, 3507 Palmilla Dr., Unit 2144, CS95134 SAN JOSE, USA (US)
(30)	Prioritet:	2020.08.31, US, 29748647, 1
(55)	Designavbildninger:	



1.1



1.2

(11)	Reg.nr.:	DM/214074
(21)	Søkn.nr.:	20210603
(22)	Inngitt i WIPO:	2021.02.11
(15)	Registrert i WIPO:	2021.02.11
(24)	Løpedag:	2021.02.11
(43)	Allm. tilgj.:	2021.08.13
(15)	Besluttet gjeldende NO:	2021.09.01
(45)	Kunngjort NO:	2021.09.20
(18)	Reg. gjelder til:	2026.02.11
(73)	Innehaver:	Abbott Diabetes Care, Inc., 1420 Harbor Bay Parkway, CA94502 ALAMEDA, USA
(50)	Anmerkninger:	Registreringen gjelder samregistrering

Design 1

(54)	Produkt:	Icon [for computers]
(51)	Klasse:	14-04
(72)	Designer:	P. Ashwin Kumar, 6451-B Benvenue Ave, CA94618 OAKLAND, USA (US) Andrew Revoltar, 455 S. 162nd St., WA98148 BURIEN, USA (US) Pooja Hebble, 3507 Palmilla Dr., Unit 2144, CA95134 SAN JOSE, USA (US)
(30)	Prioritet:	2020.08.31, US, 29748640, 1, 2
(55)	Designavbildninger:	



1.1



1.2

Design 2

(54)	Produkt:	Icon [for computers]
(51)	Klasse:	14-04
(72)	Designer:	P. Ashwin Kumar, 6451-B Benvenue Ave, CA94618 OAKLAND, USA (US) Andrew Revoltar, 455 S. 162nd St., WA98148 BURIEN, USA (US) Pooja Hebble, 3507 Palmilla Dr., Unit 2144, CA95134 SAN JOSE, USA (US)
(30)	Prioritet:	2020.08.31, US, 29748640, 1, 2
(55)	Designavbildninger:	



2.1



2.2

(11)	Reg.nr.:	DM/214078
(21)	Søkn.nr.:	20210601
(22)	Inngitt i WIPO:	2021.02.11
(15)	Registrert i WIPO:	2021.02.11
(24)	Løpedag:	2021.02.11
(43)	Allm. tilgj.:	2021.08.13
(15)	Besluttet gjeldende NO:	2021.09.02
(45)	Kunngjort NO:	2021.09.20
(18)	Reg. gjelder til:	2026.02.11
(73)	Innehaver:	Abbott Diabetes Care, Inc., 1420 Harbor Bay Parkway, CA94502 ALAMEDA, USA

Design 1

(54)	Produkt:	Icon [for computers]
(51)	Klasse:	14-04
(72)	Designer:	P. Ashwin Kumar, 6451-B Benvenue Ave, CA94618 OAKLAND, USA (US) Pooja Hebbale, 3507 Palmilla Dr., Unit 2144, CS95134 SAN JOSE, USA (US) Andrew Revoltar, 455 S. 162nd St., WA98148 BURIEN, USA (US)
(30)	Prioritet:	2020.08.31, US, 29748631, 1
(55)	Designavbildninger:	



1.1



1.2

(11)	Reg.nr.:	DM/214079
(21)	Søkn.nr.:	20210602
(22)	Inngitt i WIPO:	2021.02.11
(15)	Registrert i WIPO:	2021.02.11
(24)	Løpedag:	2021.02.11
(43)	Allm. tilgj.:	2021.08.13
(15)	Besluttet gjeldende NO:	2021.09.02
(45)	Kunngjort NO:	2021.09.20
(18)	Reg. gjelder til:	2026.02.11
(73)	Innehaver:	Abbott Diabetes Care, Inc., 1420 Harbor Bay Parkway, CA94502 ALAMEDA, USA

Design 1

(54)	Produkt:	Icon [for computers]
(51)	Klasse:	14-04
(72)	Designer:	P. Ashwin Kumar, 6451-B Benvenue Ave, CA94618 OAKLAND, USA (US) Andrew Revoltar, 455 S. 162nd St., WA98148 BURIEN, USA (US)
(30)	Prioritet:	2020.08.31, US, 29748629, 1
(55)	Designavbildninger:	



1.1



1.2

(11) Reg.nr.:	DM/214523
(21) Søkn.nr.:	20210730
(22) Inngitt i WIPO:	2021.02.25
(15) Registrert i WIPO:	2021.02.25
(24) Løpedag:	2021.02.25
(43) Allm. tilgj.:	2021.08.27
(15) Besluttet gjeldende NO:	2021.08.31
(45) Kunngjort NO:	2021.09.20
(18) Reg. gjelder til:	2026.02.25
(73) Innehaver:	Mie S.r.l., Via Alba, 26, 12060 BAROLO BAROLO, CN, Italia

Design 1

(54) Produkt:	Confectionery product
(51) Klasse:	01-01
(72) Designer:	Sandra LESINA, via Francesco Crispi, 33, 12051 ALBA, CN, Italia (IT)
(55) Designavbildninger:	

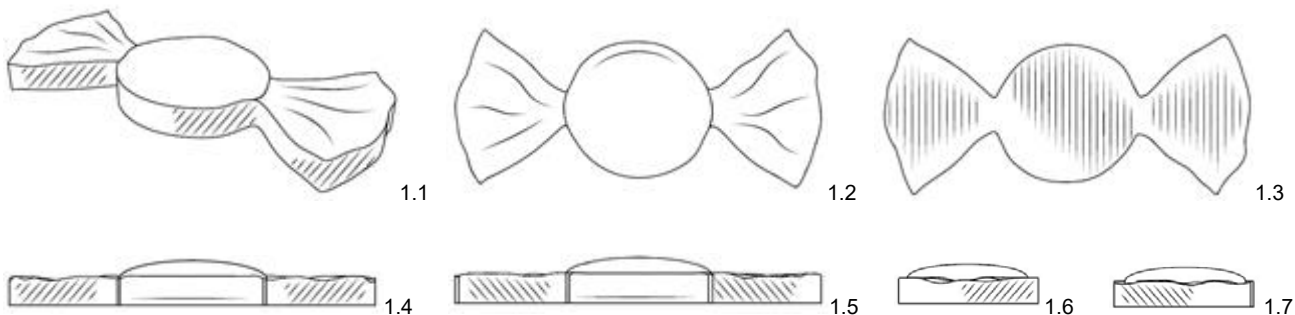

(11)	Reg.nr.:	DM/215612
(21)	Søkn.nr.:	20210797
(22)	Inngitt i WIPO:	2021.07.30
(15)	Registrert i WIPO:	2021.07.30
(24)	Løpedag:	2021.07.30
(43)	Allm. tilgj.:	2021.08.13
(15)	Besluttet gjeldende NO:	2021.09.02
(45)	Kunngjort NO:	2021.09.20
(18)	Reg. gjelder til:	2026.07.30
(73)	Innehaver:	Dr. Ing. h.c. F. Porsche Aktiengesellschaft, Porscheplatz 1, 70435 STUTTGART, Tyskland
(50)	Anmerkninger:	Registreringen gjelder samregistrering

Design 1

(54)	Produkt:	Body part for vehicles
(51)	Klasse:	12-16
(72)	Designer:	Emiel Burki, c/o Dr. Ing. h.c. F. Porsche Aktiengesellschaft Porscheplatz 1, 70435 STUTTGART, Tyskland (DE)
(30)	Prioritet:	2021.02.17, EM, 8436406, 1, 2, 3, 4, 5, 6, 7, 8, 9, 10, 11, 12, 13, 14, 15, 16, 17
(55)	Designavbildninger:	

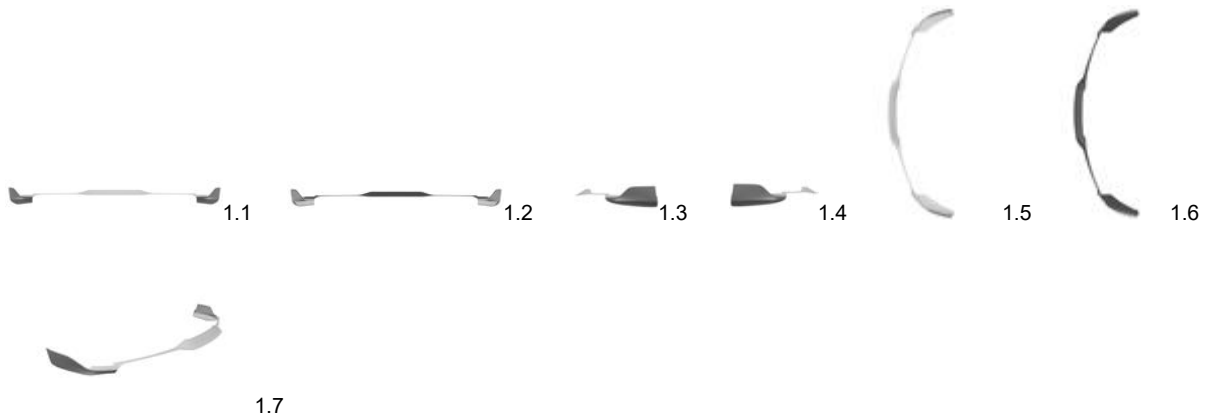
**Design 2**

(54)	Produkt:	Body part for vehicles
(51)	Klasse:	12-16
(72)	Designer:	Emiel Burki, c/o Dr. Ing. h.c. F. Porsche Aktiengesellschaft Porscheplatz 1, 70435 STUTTGART, Tyskland (DE)
(30)	Prioritet:	2021.02.17, EM, 8436406, 1, 2, 3, 4, 5, 6, 7, 8, 9, 10, 11, 12, 13, 14, 15, 16, 17
(55)	Designavbildninger:	

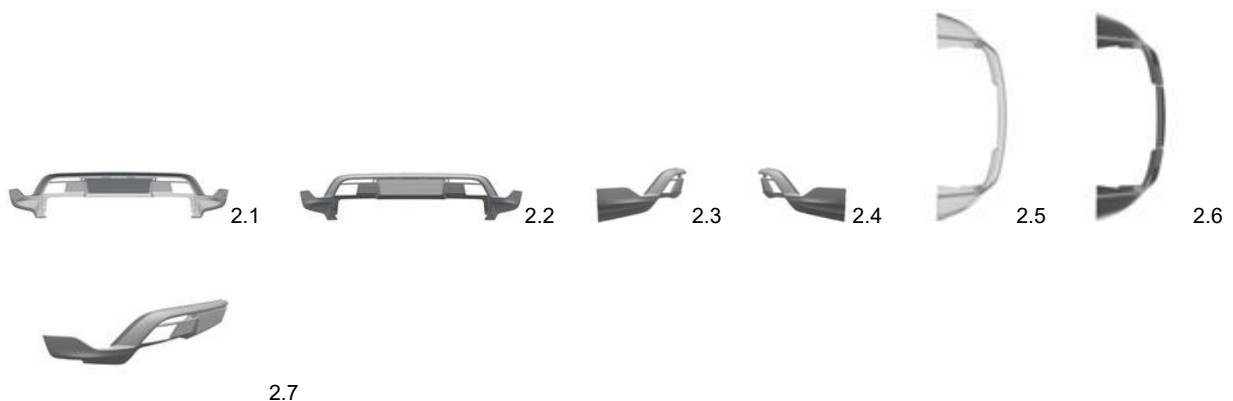

Design 3

- (54) **Produkt:** Body part for vehicles
 (51) **Klasse:** 12-16
 (72) **Designer:** Emiel Burki, c/o Dr. Ing. h.c. F. Porsche Aktiengesellschaft Porscheplatz 1, 70435 STUTTGART, Tyskland (DE)
 (30) **Prioritet:** 2021.02.17, EM, 8436406, 1, 2, 3, 4, 5, 6, 7, 8, 9, 10, 11, 12, 13, 14, 15, 16, 17
 (55) **Designavbildninger:**

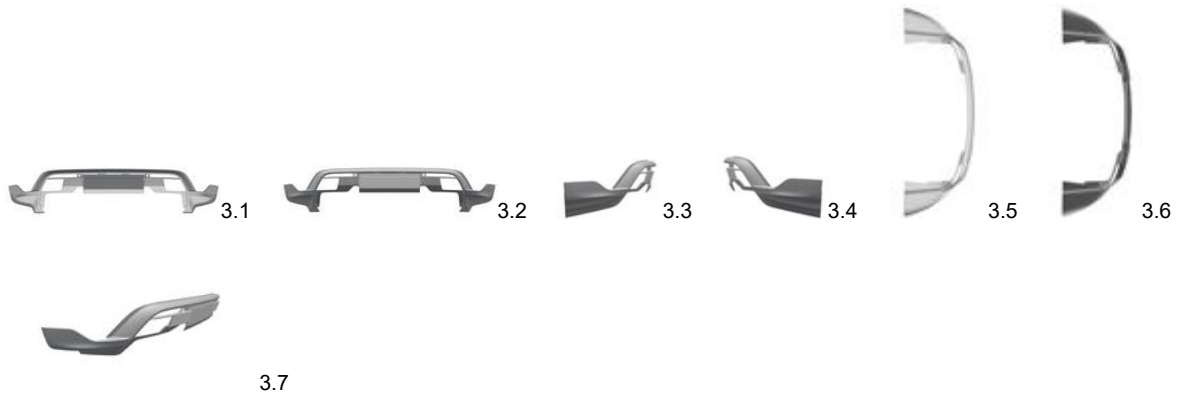
**Design 4**

- (54) **Produkt:** Body part for vehicles
 (51) **Klasse:** 12-16
 (72) **Designer:** Emiel Burki, c/o Dr. Ing. h.c. F. Porsche Aktiengesellschaft Porscheplatz 1, 70435 STUTTGART, Tyskland (DE)
 (30) **Prioritet:** 2021.02.17, EM, 8436406, 1, 2, 3, 4, 5, 6, 7, 8, 9, 10, 11, 12, 13, 14, 15, 16, 17
 (55) **Designavbildninger:**

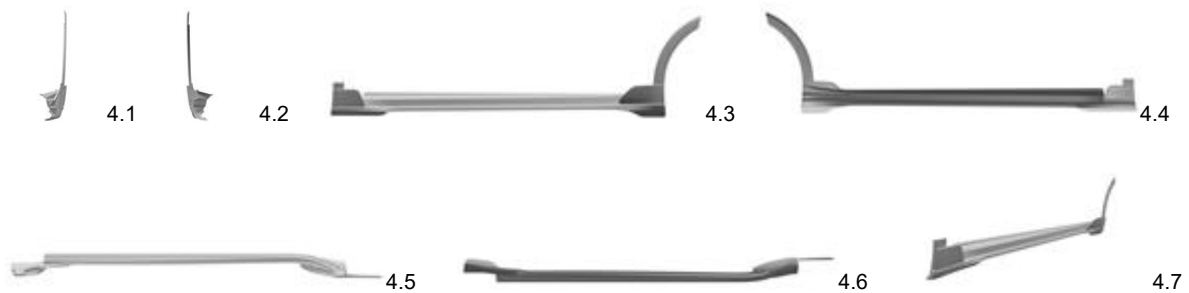
**Design 5**

- (54) **Produkt:** Body part for vehicles
 (51) **Klasse:** 12-16
 (72) **Designer:** Emiel Burki, c/o Dr. Ing. h.c. F. Porsche Aktiengesellschaft Porscheplatz 1, 70435 STUTTGART, Tyskland (DE)
 (30) **Prioritet:** 2021.02.17, EM, 8436406, 1, 2, 3, 4, 5, 6, 7, 8, 9, 10, 11, 12, 13, 14, 15, 16, 17
 (55) **Designavbildninger:**

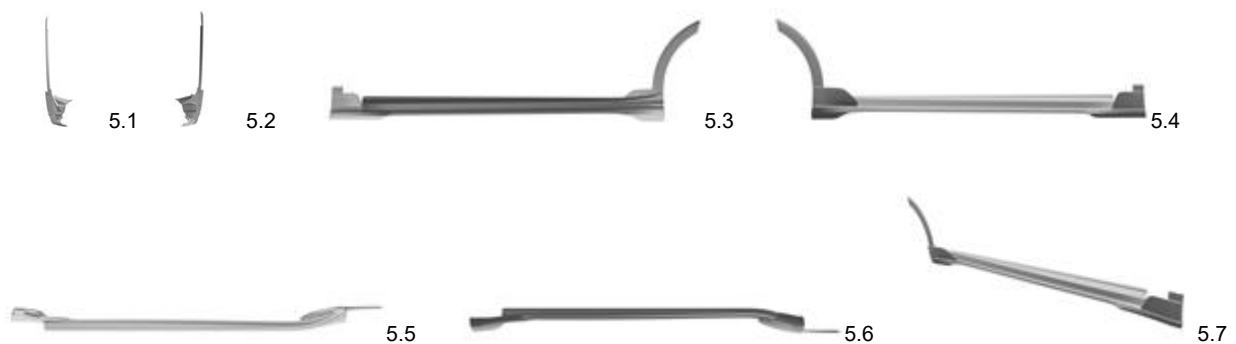

Design 6

- (54) **Produkt:** Body part for vehicles
 (51) **Klasse:** 12-16
 (72) **Designer:** Emiel Burki, c/o Dr. Ing. h.c. F. Porsche Aktiengesellschaft Porscheplatz 1, 70435 STUTTGART, Tyskland (DE)
 (30) **Prioritet:** 2021.02.17, EM, 8436406, 1, 2, 3, 4, 5, 6, 7, 8, 9, 10, 11, 12, 13, 14, 15, 16, 17
 (55) **Designavbildninger:**

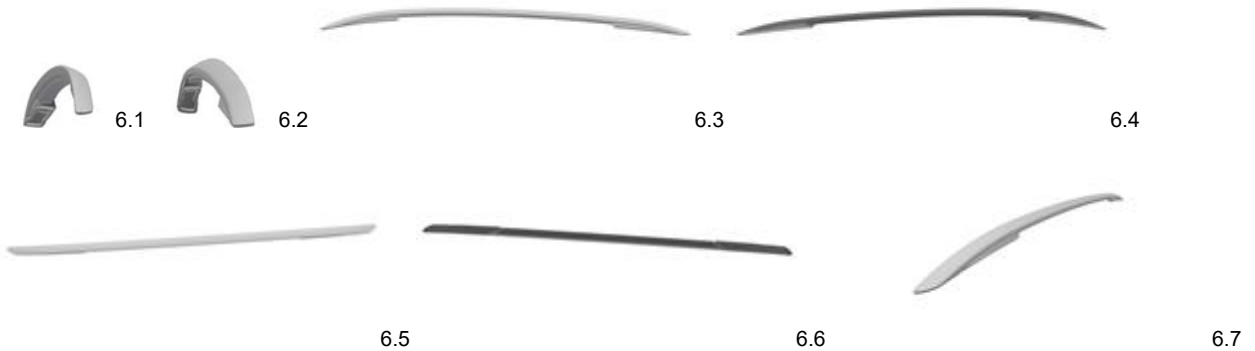
**Design 7**

- (54) **Produkt:** Body part for vehicles
 (51) **Klasse:** 12-16
 (72) **Designer:** Emiel Burki, c/o Dr. Ing. h.c. F. Porsche Aktiengesellschaft Porscheplatz 1, 70435 STUTTGART, Tyskland (DE)
 (30) **Prioritet:** 2021.02.17, EM, 8436406, 1, 2, 3, 4, 5, 6, 7, 8, 9, 10, 11, 12, 13, 14, 15, 16, 17
 (55) **Designavbildninger:**

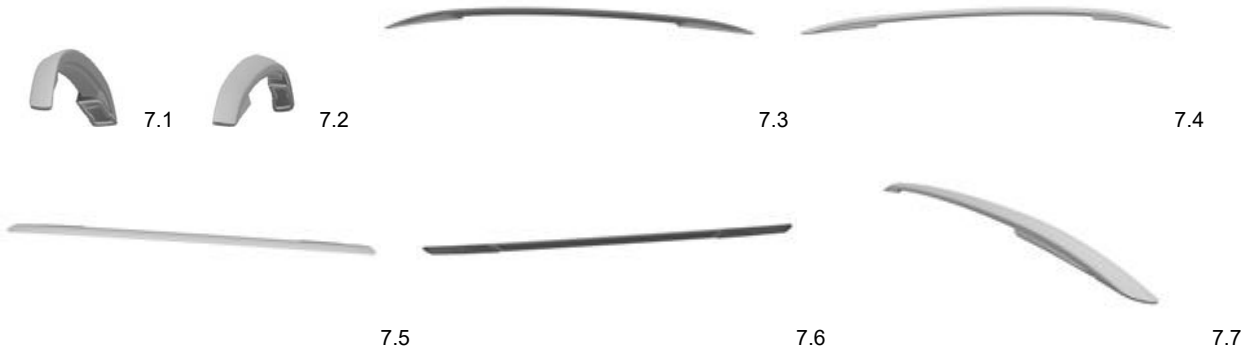
**Design 8**

- (54) **Produkt:** Body part for vehicles
 (51) **Klasse:** 12-16
 (72) **Designer:** Emiel Burki, c/o Dr. Ing. h.c. F. Porsche Aktiengesellschaft Porscheplatz 1, 70435 STUTTGART, Tyskland (DE)
 (30) **Prioritet:** 2021.02.17, EM, 8436406, 1, 2, 3, 4, 5, 6, 7, 8, 9, 10, 11, 12, 13, 14, 15, 16, 17
 (55) **Designavbildninger:**

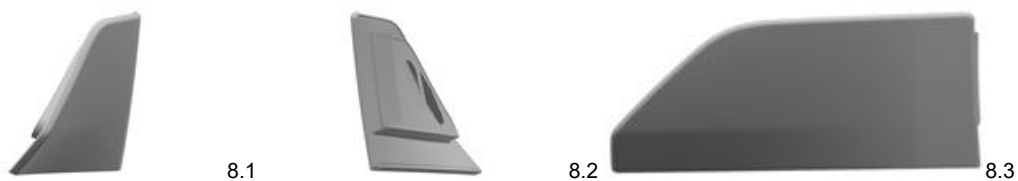



8.4



8.5



8.6



8.7

Design 9

- (54) **Produkt:** Body part for vehicles
(51) **Klasse:** 12-16
(72) **Designer:** Emiel Burki, c/o Dr. Ing. h.c. F. Porsche Aktiengesellschaft Porscheplatz 1, 70435 STUTTGART, Tyskland (DE)
(30) **Prioritet:** 2021.02.17, EM, 8436406, 1, 2, 3, 4, 5, 6, 7, 8, 9, 10, 11, 12, 13, 14, 15, 16, 17
(55) **Designavbildninger:**



9.1



9.2



9.3



9.4



9.5



9.6



9.7

Design 10

- (54) **Produkt:** Body part for vehicles
 (51) **Klasse:** 12-16
 (72) **Designer:** Emiel Burki, c/o Dr. Ing. h.c. F. Porsche Aktiengesellschaft Porscheplatz 1, 70435 STUTTGART, Tyskland (DE)
 (30) **Prioritet:** 2021.02.17, EM, 8436406, 1, 2, 3, 4, 5, 6, 7, 8, 9, 10, 11, 12, 13, 14, 15, 16, 17
 (55) **Designavbildninger:**



10.1



10.2



10.3



10.4



10.5



10.6



10.7

Design 11

- (54) **Produkt:** Body part for vehicles
 (51) **Klasse:** 12-16
 (72) **Designer:** Emiel Burki, c/o Dr. Ing. h.c. F. Porsche Aktiengesellschaft Porscheplatz 1, 70435 STUTTGART, Tyskland (DE)
 (30) **Prioritet:** 2021.02.17, EM, 8436406, 1, 2, 3, 4, 5, 6, 7, 8, 9, 10, 11, 12, 13, 14, 15, 16, 17
 (55) **Designavbildninger:**



11.1



11.2



11.3



11.4



11.5



11.6



11.7

Design 12

(54) **Produkt:** Body part for vehicles
 (51) **Klasse:** 12-16
 (72) **Designer:** Emiel Burki, c/o Dr. Ing. h.c. F. Porsche Aktiengesellschaft Porscheplatz 1, 70435 STUTTGART, Tyskland (DE)
 (30) **Prioritet:** 2021.02.17, EM, 8436406, 1, 2, 3, 4, 5, 6, 7, 8, 9, 10, 11, 12, 13, 14, 15, 16, 17
 (55) **Designavbildninger:**



12.1



12.2



12.3



12.4



12.5



12.6



12.7

Design 13

(54) **Produkt:** Body part for vehicles
 (51) **Klasse:** 12-16
 (72) **Designer:** Emiel Burki, c/o Dr. Ing. h.c. F. Porsche Aktiengesellschaft Porscheplatz 1, 70435 STUTTGART, Tyskland (DE)
 (30) **Prioritet:** 2021.02.17, EM, 8436406, 1, 2, 3, 4, 5, 6, 7, 8, 9, 10, 11, 12, 13, 14, 15, 16, 17
 (55) **Designavbildninger:**



13.1



13.2



13.3



13.4



13.5



13.6



13.7

Design 14

(54) **Produkt:** Body part for vehicles
 (51) **Klasse:** 12-16
 (72) **Designer:** Emiel Burki, c/o Dr. Ing. h.c. F. Porsche Aktiengesellschaft Porscheplatz 1, 70435 STUTTGART, Tyskland (DE)
 (30) **Prioritet:** 2021.02.17, EM, 8436406, 1, 2, 3, 4, 5, 6, 7, 8, 9, 10, 11, 12, 13, 14, 15, 16, 17
 (55) **Designavbildninger:**



14.1



14.2



14.3



14.4



14.5



14.6



14.7

Design 15

(54) **Produkt:** Body part for vehicles
 (51) **Klasse:** 12-16
 (72) **Designer:** Emiel Burki, c/o Dr. Ing. h.c. F. Porsche Aktiengesellschaft Porscheplatz 1, 70435 STUTTGART, Tyskland (DE)
 (30) **Prioritet:** 2021.02.17, EM, 8436406, 1, 2, 3, 4, 5, 6, 7, 8, 9, 10, 11, 12, 13, 14, 15, 16, 17
 (55) **Designavbildninger:**



15.1



15.2



15.3



15.4



15.5



15.6



15.7

Design 16

- (54) **Produkt:** Body part for vehicles
 (51) **Klasse:** 12-16
 (72) **Designer:** Emiel Burki, c/o Dr. Ing. h.c. F. Porsche Aktiengesellschaft Porscheplatz 1, 70435 STUTTGART, Tyskland (DE)
 (30) **Prioritet:** 2021.02.17, EM, 8436406, 1, 2, 3, 4, 5, 6, 7, 8, 9, 10, 11, 12, 13, 14, 15, 16, 17
 (55) **Designavbildninger:**



16.1



16.2



16.3



16.4



16.5



16.6



16.7

Design 17

- (54) **Produkt:** Body part for vehicles
 (51) **Klasse:** 12-16
 (72) **Designer:** Emiel Burki, c/o Dr. Ing. h.c. F. Porsche Aktiengesellschaft Porscheplatz 1, 70435 STUTTGART, Tyskland (DE)
 (30) **Prioritet:** 2021.02.17, EM, 8436406, 1, 2, 3, 4, 5, 6, 7, 8, 9, 10, 11, 12, 13, 14, 15, 16, 17
 (55) **Designavbildninger:**



17.1



17.2



17.3



17.4



17.5



17.6



17.7

(11)	Reg.nr.:	DM/215615
(21)	Søkn.nr.:	20210798
(22)	Inngitt i WIPO:	2021.07.30
(15)	Registrert i WIPO:	2021.07.30
(24)	Løpedag:	2021.07.30
(43)	Allm. tilgj.:	2021.08.13
(15)	Besluttet gjeldende NO:	2021.09.02
(45)	Kunngjort NO:	2021.09.20
(18)	Reg. gjelder til:	2026.07.30
(73)	Innehaver:	GUALA DISPENSING S.P.A., Zona Ind. D/5 - Spinetta Marengo, 15122 ALESSANDRIA, Italia

Design 1

(54)	Produkt:	Toothpaste dispenser
(51)	Klasse:	23-08
(72)	Designer:	Marco Pepe, c/o GUALA DISPENSING S.P.A. Zona Ind. D/5 - Spinetta Marengo, 15122 ALESSANDRIA, Italia (IT)
(55)	Designavbildninger:	



1.1



1.2



1.3



1.4



1.5



1.6



1.7



1.8

(11)	Reg.nr.:	DM/215623
(21)	Søkn.nr.:	20210799
(22)	Inngitt i WIPO:	2021.07.26
(15)	Registrert i WIPO:	2021.07.26
(24)	Løpedag:	2021.07.26
(43)	Allm. tilgj.:	2021.08.13
(15)	Besluttet gjeldende NO:	2021.09.02
(45)	Kunngjort NO:	2021.09.20
(18)	Reg. gjelder til:	2026.07.26
(73)	Innehaver:	PSA AUTOMOBILES SA, 2-10 Boulevard de l'Europe, 78300 POISSY, Frankrike
(50)	Anmerkninger:	Registreringen gjelder samregistrering

Design 1

(54)	Produkt:	Front daytime running light for vehicle
(51)	Klasse:	26-06
(72)	Designer:	Jean-Pierre PLOUE, Route de Gisy, 78140 VELIZY VILLACOUBLAY, Frankrike (FR)
(30)	Prioritet:	2021.02.17, EM, 008436836, 1, 2, 3, 4, 5, 6, 7, 8
(55)	Designavbildninger:	



1.1



1.2



1.3



1.4



1.5

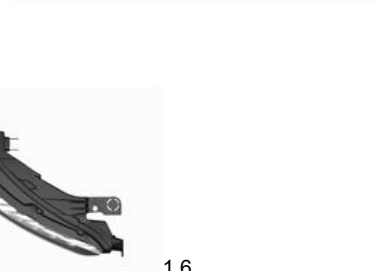

1.6



1.7

Design 2

(54)	Produkt:	Front daytime running light for vehicle
(51)	Klasse:	26-06
(72)	Designer:	Jean-Pierre PLOUE, Route de Gisy, 78140 VELIZY VILLACOUBLAY, Frankrike (FR)
(30)	Prioritet:	2021.02.17, EM, 008436836, 1, 2, 3, 4, 5, 6, 7, 8
(55)	Designavbildninger:	



2.1



2.2



2.3



2.4



2.5



2.6



2.7

Design 3

(54) **Produkt:** Headlight for vehicle
(51) **Klasse:** 26-06
(72) **Designer:** Jean-Pierre PLOUE, Route de Gisy, 78140 VELIZY VILLACOUBLAY, Frankrike (FR)
(30) **Prioritet:** 2021.02.17, EM, 008436836, 1, 2, 3, 4, 5, 6, 7, 8
(55) **Designavbildninger:**



3.1



3.2



3.3



3.4



3.5



3.6



3.7

Design 4

- (54) **Produkt:** Headlight for vehicle
(51) **Klasse:** 26-06
(72) **Designer:** Jean-Pierre PLOUE, Route de Gisy, 78140 VELIZY VILLACOUBLAY, Frankrike (FR)
(30) **Prioritet:** 2021.02.17, EM, 008436836, 1, 2, 3, 4, 5, 6, 7, 8
(55) **Designavbildninger:**



4.1



4.2



4.3



4.4



4.5



4.6



4.7

Design 5

- (54) **Produkt:** Rear wing lamp cluster for vehicle
(51) **Klasse:** 26-06
(72) **Designer:** Jean-Pierre PLOUE, Route de Gisy, 78140 VELIZY VILLACOUBLAY, Frankrike (FR)
(30) **Prioritet:** 2021.02.17, EM, 008436836, 1, 2, 3, 4, 5, 6, 7, 8
(55) **Designavbildninger:**



5.1



5.2



5.3



5.4



5.5



5.6



5.7

Design 6

- (54) **Produkt:** Rear wing lamp cluster for vehicle
 (51) **Klasse:** 26-06
 (72) **Designer:** Jean-Pierre PLOUE, Route de Gisy, 78140 VELIZY VILLACOUBLAY, Frankrike (FR)
 (30) **Prioritet:** 2021.02.17, EM, 008436836, 1, 2, 3, 4, 5, 6, 7, 8
 (55) **Designavbildninger:**



6.1



6.2



6.3



6.4



6.5



6.6



6.7

Design 7

- (54) **Produkt:** Tailgate lamp cluster for vehicle
 (51) **Klasse:** 26-06
 (72) **Designer:** Jean-Pierre PLOUE, Route de Gisy, 78140 VELIZY VILLACOUBLAY, Frankrike (FR)
 (30) **Prioritet:** 2021.02.17, EM, 008436836, 1, 2, 3, 4, 5, 6, 7, 8
 (55) **Designavbildninger:**



7.1



7.2



7.3



7.4



7.5



7.6



7.7

Design 8

(54) **Produkt:** Tailgate lamp cluster for vehicle
(51) **Klasse:** 26-06
(72) **Designer:** Jean-Pierre PLOUE, Route de Gisy, 78140 VELIZY VILLACOUBLAY, Frankrike (FR)
(30) **Prioritet:** 2021.02.17, EM, 008436836, 1, 2, 3, 4, 5, 6, 7, 8
(55) **Designavbildninger:**



8.1



8.2



8.3



8.4



8.5



8.6



8.7

(11)	Reg.nr.:	DM/215624
(21)	Søkn.nr.:	20210800
(22)	Inngitt i WIPO:	2021.07.26
(15)	Registrert i WIPO:	2021.07.26
(24)	Løpedag:	2021.07.26
(43)	Allm. tilgj.:	2021.08.13
(15)	Besluttet gjeldende NO:	2021.09.02
(45)	Kunngjort NO:	2021.09.20
(18)	Reg. gjelder til:	2026.07.26
(73)	Innehaver:	PSA AUTOMOBILES SA, 2-10 Boulevard de l'Europe, 78300 POISSY, Frankrike
(50)	Anmerkninger:	Registreringen gjelder samregistrering

Design 1

(54)	Produkt:	Motor vehicle
(51)	Klasse:	12-08
(72)	Designer:	Jean-Pierre PLOUE, Route de Gisy, 78140 VELIZY VILLACOUBLAY, Frankrike (FR)
(30)	Prioritet:	2021.02.17, EM, 008435481, 1, 2
(55)	Designavbildninger:	



1.1



1.2



1.3



1.4



1.5



1.6



1.7

Design 2

- (54) **Produkt:** Motor vehicle
(51) **Klasse:** 12-08
(72) **Designer:** Jean-Pierre PLOUE, Route de Gisy, 78140 VELIZY VILLACOUBLAY, Frankrike (FR)
(30) **Prioritet:** 2021.02.17, EM, 008435481, 1, 2
(55) **Designavbildninger:**



2.1



2.2



2.3



2.4



2.5



2.6



2.7

(11)	Reg.nr.:	DM/215631
(21)	Søkn.nr.:	20210801
(22)	Inngitt i WIPO:	2021.07.28
(15)	Registrert i WIPO:	2021.07.28
(24)	Løpedag:	2021.07.28
(43)	Allm. tilgj.:	2021.08.13
(15)	Besluttet gjeldende NO:	2021.09.02
(45)	Kunngjort NO:	2021.09.20
(18)	Reg. gjelder til:	2026.07.28
(73)	Innehaver:	Mayr-Melnhof Packaging Austria GmbH, Scheydgasse 46, 1210 WIEN, Østerrike
(50)	Anmerkninger:	Registreringen gjelder samregistrering

Design 1

(54)	Produkt:	Cardboard box [packaging]
(51)	Klasse:	09-03
(72)	Designer:	
(30)	Prioritet:	2021.03.11, EP, 008460224, 1, 2
(55)	Designavbildninger:	





1.7

Design 2

(54) **Produkt:** Cardboard box [packaging]
(51) **Klasse:** 09-03
(72) **Designer:**
(30) **Prioritet:** 2021.03.11, EP, 008460224, 1, 2
(55) **Designavbildninger:**



2.1



2.2



2.3



2.4



2.5



2.6



2.7

(11)	Reg.nr.:	DM/215637
(21)	Søkn.nr.:	20210883
(22)	Inngitt i WIPO:	2021.07.28
(15)	Registrert i WIPO:	2021.07.28
(24)	Løpedag:	2021.07.28
(43)	Allm. tilgj.:	2021.08.13
(15)	Besluttet gjeldende NO:	2021.09.03
(45)	Kunngjort NO:	2021.09.20
(18)	Reg. gjelder til:	2026.07.28
(73)	Innehaver:	Wahl GmbH, Roggenbachweg 9, 78089 UNTERKIRNACH, Tyskland
(50)	Anmerkninger:	Registreringen gjelder samregistrering

Design 1

(54)	Produkt:	Hair clipper
(51)	Klasse:	28-03
(72)	Designer:	Sven Lambrecht, Vogesenweg 15/1, 78056 VILLINGEN-SCHWENNINGEN, Tyskland (DE)
(30)	Prioritet:	2021.02.01, EM, 008422380, 1, 2
(55)	Designavbildninger:	



1.1



1.2



1.3



1.4



1.5



1.6



1.7

Design 2

(54) **Produkt:** Hair clipper
(51) **Klasse:** 28-03
(72) **Designer:** Sven Lambrecht, Vogesenweg 15/1, 78056 VILLINGEN-SCHWENNINGEN, Tyskland (DE)
(30) **Prioritet:** 2021.02.01, EM, 008422380, 1, 2
(55) **Designavbildninger:**



2.1



2.2



2.3



2.4



2.5



2.6



2.7

(11)	Reg.nr.:	DM/215643
(21)	Søkn.nr.:	20210802
(22)	Inngitt i WIPO:	2021.07.26
(15)	Registrert i WIPO:	2021.07.26
(24)	Løpedag:	2021.07.26
(43)	Allm. tilgj.:	2021.08.13
(15)	Besluttet gjeldende NO:	2021.09.03
(45)	Kunngjort NO:	2021.09.20
(18)	Reg. gjelder til:	2026.07.26
(73)	Innehaver:	PSA AUTOMOBILES SA, 2-10 Boulevard de l'Europe, 78300 POISSY, Frankrike
(50)	Anmerkninger:	Registreringen gjelder samregistrering

Design 1

(54)	Produkt:	Vehicle door
(51)	Klasse:	12-16
(72)	Designer:	Jean-Pierre PLOUE, Route de Gisy, 78140 VELIZY VILLACOUBLAY, Frankrike (FR)
(30)	Prioritet:	2021.02.17, EM, 008436844, 1, 2, 3, 4, 5, 6, 7, 8, 9, 10, 11, 12, 13, 14, 15, 16, 17
(55)	Designavbildninger:	



1.1



1.2



1.3



1.4



1.5



1.6



1.7

Design 2

(54)	Produkt:	Vehicle door
(51)	Klasse:	12-16
(72)	Designer:	Jean-Pierre PLOUE, Route de Gisy, 78140 VELIZY VILLACOUBLAY, Frankrike (FR)
(30)	Prioritet:	2021.02.17, EM, 008436844, 1, 2, 3, 4, 5, 6, 7, 8, 9, 10, 11, 12, 13, 14, 15, 16, 17
(55)	Designavbildninger:	



2.1



2.2



2.3



2.4



2.5



2.6



2.7

Design 3

(54) **Produkt:** Vehicle door
(51) **Klasse:** 12-16
(72) **Designer:** Jean-Pierre PLOUE, Route de Gisy, 78140 VELIZY VILLACOUBLAY, Frankrike (FR)
(30) **Prioritet:** 2021.02.17, EM, 008436844, 1, 2, 3, 4, 5, 6, 7, 8, 9, 10, 11, 12, 13, 14, 15, 16, 17
(55) **Designavbildninger:**



3.1



3.2



3.3



3.4



3.5



3.6



3.7

Design 4

- (54) **Produkt:** Vehicle door
(51) **Klasse:** 12-16
(72) **Designer:** Jean-Pierre PLOUE, Route de Gisy, 78140 VELIZY VILLACOUBLAY, Frankrike (FR)
(30) **Prioritet:** 2021.02.17, EM, 008436844, 1, 2, 3, 4, 5, 6, 7, 8, 9, 10, 11, 12, 13, 14, 15, 16, 17
(55) **Designavbildninger:**



4.1



4.2



4.3



4.4



4.5



4.6



4.7

Design 5

- (54) **Produkt:** Air-intake grille for vehicle
(51) **Klasse:** 12-16
(72) **Designer:** Jean-Pierre PLOUE, Route de Gisy, 78140 VELIZY VILLACOUBLAY, Frankrike (FR)
(30) **Prioritet:** 2021.02.17, EM, 008436844, 1, 2, 3, 4, 5, 6, 7, 8, 9, 10, 11, 12, 13, 14, 15, 16, 17
(55) **Designavbildninger:**



5.1



5.2



5.3



5.4



5.5



5.6



5.7

Design 6

- (54) **Produkt:** Lower front bumper
(51) **Klasse:** 12-16
(72) **Designer:** Jean-Pierre PLOUE, Route de Gisy, 78140 VELIZY VILLACOUBLAY, Frankrike (FR)
(30) **Prioritet:** 2021.02.17, EM, 008436844, 1, 2, 3, 4, 5, 6, 7, 8, 9, 10, 11, 12, 13, 14, 15, 16, 17
(55) **Designavbildninger:**



6.1



6.2



6.3



6.4



6.5



6.6



6.7

Design 7

- (54) **Produkt:** Front bumper
(51) **Klasse:** 12-16
(72) **Designer:** Jean-Pierre PLOUE, Route de Gisy, 78140 VELIZY VILLACOUBLAY, Frankrike (FR)
(30) **Prioritet:** 2021.02.17, EM, 008436844, 1, 2, 3, 4, 5, 6, 7, 8, 9, 10, 11, 12, 13, 14, 15, 16, 17
(55) **Designavbildninger:**



7.1



7.2



7.3



7.4



7.5



7.6



7.7

Design 8

- (54) **Produkt:** Vehicle bonnet
(51) **Klasse:** 12-16
(72) **Designer:** Jean-Pierre PLOUE, Route de Gisy, 78140 VELIZY VILLACOUBLAY, Frankrike (FR)
(30) **Prioritet:** 2021.02.17, EM, 008436844, 1, 2, 3, 4, 5, 6, 7, 8, 9, 10, 11, 12, 13, 14, 15, 16, 17
(55) **Designavbildninger:**



8.1



8.2



8.3



8.4



8.5



8.6



8.7

Design 9

(54) **Produkt:** Left side rear bumper
 (51) **Klasse:** 12-16
 (72) **Designer:** Jean-Pierre PLOUE, Route de Gisy, 78140 VELIZY VILLACOUBLAY, Frankrike (FR)
 (30) **Prioritet:** 2021.02.17, EM, 008436844, 1, 2, 3, 4, 5, 6, 7, 8, 9, 10, 11, 12, 13, 14, 15, 16, 17
 (55) **Designavbildninger:**



9.1



9.2



9.3



9.4



9.5



9.6



9.7

Design 10

(54) **Produkt:** Right side rear bumper
 (51) **Klasse:** 12-16
 (72) **Designer:** Jean-Pierre PLOUE, Route de Gisy, 78140 VELIZY VILLACOUBLAY, Frankrike (FR)
 (30) **Prioritet:** 2021.02.17, EM, 008436844, 1, 2, 3, 4, 5, 6, 7, 8, 9, 10, 11, 12, 13, 14, 15, 16, 17
 (55) **Designavbildninger:**



10.1



10.2



10.3



10.4



10.5



10.6



10.7

Design 11

(54) **Produkt:** Lower rear bumper
(51) **Klasse:** 12-16
(72) **Designer:** Jean-Pierre PLOUE, Route de Gisy, 78140 VELIZY VILLACOUBLAY, Frankrike (FR)
(30) **Prioritet:** 2021.02.17, EM, 008436844, 1, 2, 3, 4, 5, 6, 7, 8, 9, 10, 11, 12, 13, 14, 15, 16, 17
(55) **Designavbildninger:**



11.1



11.2



11.3



11.4



11.5



11.6



11.7

Design 12

(54) **Produkt:** Spoiler for motor car
 (51) **Klasse:** 12-16
 (72) **Designer:** Jean-Pierre PLOUE, Route de Gisy, 78140 VELIZY VILLACOUBLAY, Frankrike (FR)
 (30) **Prioritet:** 2021.02.17, EM, 008436844, 1, 2, 3, 4, 5, 6, 7, 8, 9, 10, 11, 12, 13, 14, 15, 16, 17
 (55) **Designavbildninger:**



12.1



12.2



12.3



12.4



12.5



12.6



12.7

Design 13

(54) **Produkt:** Parcel shelf for boot
 (51) **Klasse:** 12-16
 (72) **Designer:** Jean-Pierre PLOUE, Route de Gisy, 78140 VELIZY VILLACOUBLAY, Frankrike (FR)
 (30) **Prioritet:** 2021.02.17, EM, 008436844, 1, 2, 3, 4, 5, 6, 7, 8, 9, 10, 11, 12, 13, 14, 15, 16, 17
 (55) **Designavbildninger:**



13.1



13.2



13.3



13.4



13.5



13.6



13.7

Design 14

- (54) **Produkt:** Rear hatch for boot
 (51) **Klasse:** 12-16
 (72) **Designer:** Jean-Pierre PLOUE, Route de Gisy, 78140 VELIZY VILLACOUBLAY, Frankrike (FR)
 (30) **Prioritet:** 2021.02.17, EM, 008436844, 1, 2, 3, 4, 5, 6, 7, 8, 9, 10, 11, 12, 13, 14, 15, 16, 17
 (55) **Designavbildninger:**



14.1



14.2



14.3



14.4



14.5



14.6



14.7

Design 15

- (54) **Produkt:** Radiator grille for vehicle
 (51) **Klasse:** 12-16
 (72) **Designer:** Jean-Pierre PLOUE, Route de Gisy, 78140 VELIZY VILLACOUBLAY, Frankrike (FR)
 (30) **Prioritet:** 2021.02.17, EM, 008436844, 1, 2, 3, 4, 5, 6, 7, 8, 9, 10, 11, 12, 13, 14, 15, 16, 17
 (55) **Designavbildninger:**



15.1



15.2



15.3



15.4



15.5



15.6



15.7

Design 16

- (54) **Produkt:** Vehicle wing
(51) **Klasse:** 12-16
(72) **Designer:** Jean-Pierre PLOUE, Route de Gisy, 78140 VELIZY VILLACOUBLAY, Frankrike (FR)
(30) **Prioritet:** 2021.02.17, EM, 008436844, 1, 2, 3, 4, 5, 6, 7, 8, 9, 10, 11, 12, 13, 14, 15, 16, 17
(55) **Designavbildninger:**



16.1



16.2



16.3



16.4



16.5



16.6



16.7

Design 17

(54) **Produkt:** Vehicle wing
(51) **Klasse:** 12-16
(72) **Designer:** Jean-Pierre PLOUE, Route de Gisy, 78140 VELIZY VILLACOUBLAY, Frankrike (FR)
(30) **Prioritet:** 2021.02.17, EM, 008436844, 1, 2, 3, 4, 5, 6, 7, 8, 9, 10, 11, 12, 13, 14, 15, 16, 17
(55) **Designavbildninger:**



17.1



17.2



17.3



17.4



17.5



17.6



17.7

(11)	Reg.nr.:	DM/215649
(21)	Søkn.nr.:	20210803
(22)	Inngitt i WIPO:	2021.05.21
(15)	Registrert i WIPO:	2021.05.21
(24)	Løpedag:	2021.05.21
(43)	Allm. tilgj.:	2021.08.13
(15)	Besluttet gjeldende NO:	2021.09.03
(45)	Kunngjort NO:	2021.09.20
(18)	Reg. gjelder til:	2026.05.21
(73)	Innehaver:	Takeda Pharmaceutical Company Limited, 1-1 Doshomachi 4-Chome, Chuo-Ku, Osaka-Shi, 541-0045 OSAKA, Japan
(50)	Anmerkninger:	Registreringen gjelder samregistrering

Design 1

(54)	Produkt:	Box [packaging]
(51)	Klasse:	09-03
(72)	Designer:	Jeffrey Peltier, c/o Takeda Pharmaceutical Company Limited, 1-1, Doshomachi 4-chome, Chuo-ku, Osaka-Shi, 541-0045 OSAKA, Japan (JP) Peter Murphy, c/o Design Partners, IDA Business Park, Southern Cross Route, A98Y6WO BRAY, CO. WICKLOW, Irland (IE) Terence Kealy, c/o Design Partners, IDA Business Park, Southern Cross Route, A98Y6WO BRAY, CO. WICKLOW, Irland (IE) Eugene Canavan, c/o Design Partners, IDA Business Park, Southern Cross Route, A98Y6WO BRAY, CO. WICKLOW, Irland (IE)
(30)	Prioritet:	2020.11.24, US, 29/759,591, 1, 2, 3
(55)	Designavbildninger:	

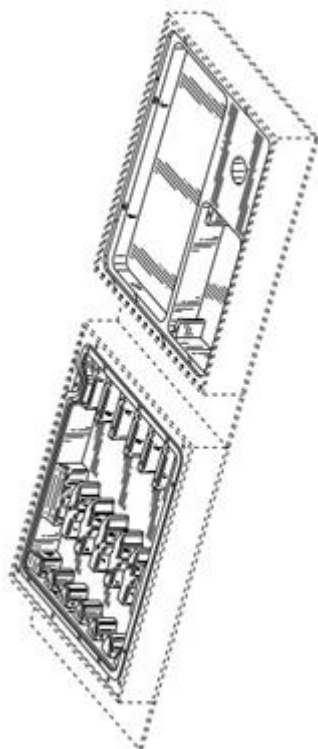

1.1

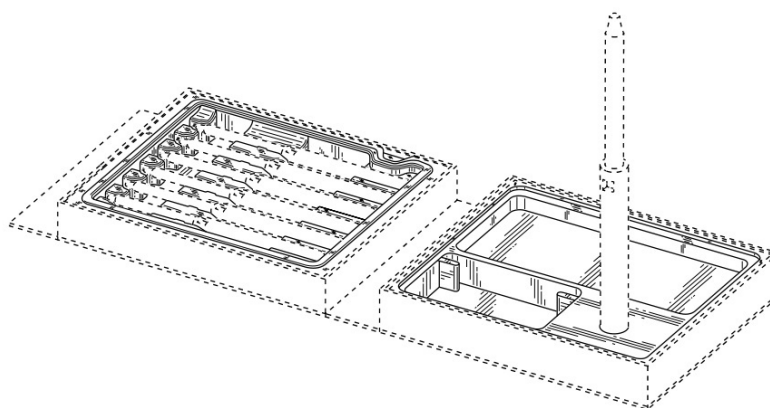

1.2

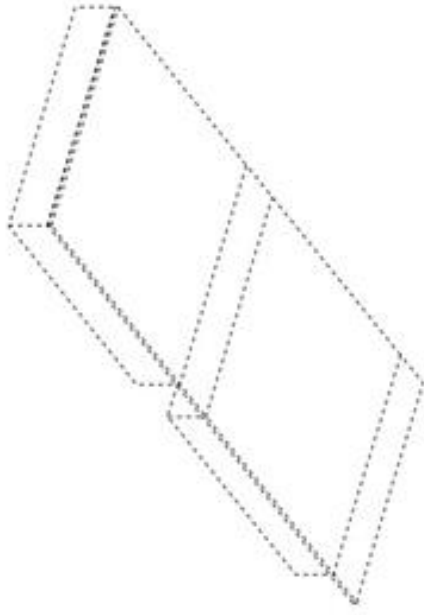

1.3



1.4

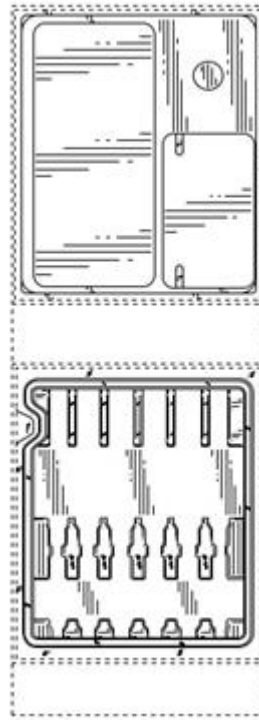

1.5



1.6

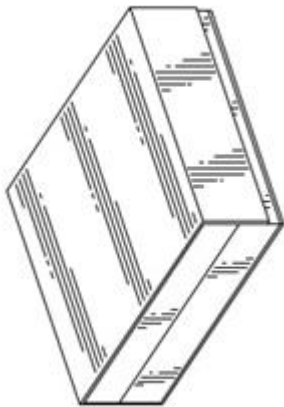

1.7

Design 2

- (54) **Produkt:** Box [packaging]
(51) **Klasse:** 09-03
(72) **Designer:** Jeffrey Peltier, c/o Takeda Pharmaceutical Company Limited, 1-1, Doshomachi 4-chome, Chuo-ku, Osaka-Shi, 541-0045 OSAKA, Japan (JP)
Peter Murphy, c/o Design Partners, IDA Business Park, Southern Cross Route, A98Y6WO BRAY, CO. WICKLOW, Irland (IE)
Terence Kealy, c/o Design Partners, IDA Business Park, Southern Cross Route, A98Y6WO BRAY, CO. WICKLOW, Irland (IE)
Eugene Canavan, c/o Design Partners, IDA Business Park, Southern Cross Route, A98Y6WO BRAY, CO. WICKLOW, Irland (IE)
(30) **Prioritet:** 2020.11.24, US, 29/759,591, 1, 2, 3
(55) **Designavbildninger:**

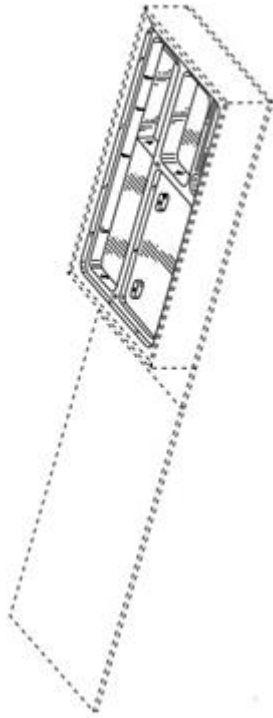

2.1

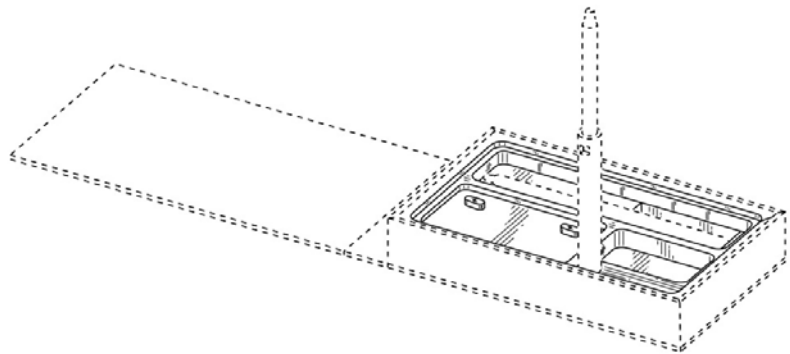

2.2

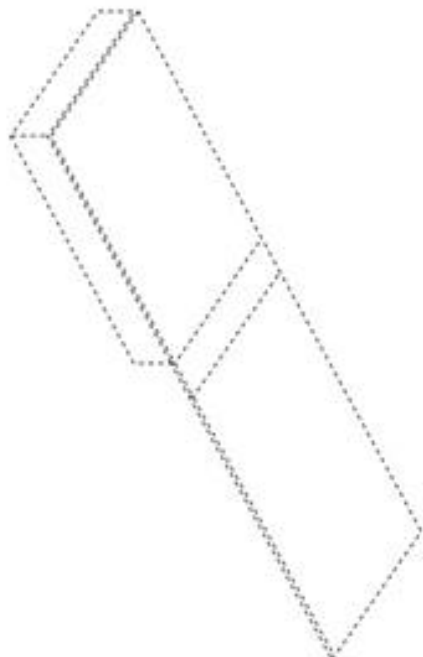

2.3



2.4

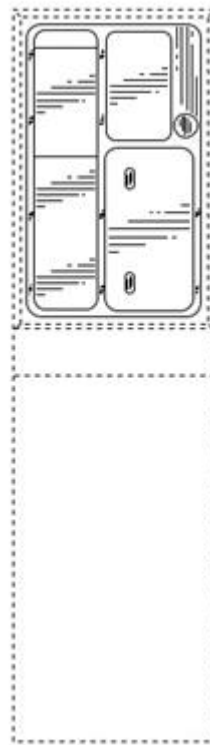

2.5



2.6

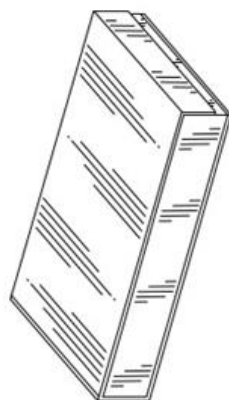

2.7

Design 3

- (54) **Produkt:** Box [packaging]
(51) **Klasse:** 09-03
(72) **Designer:** Jeffrey Peltier, c/o Takeda Pharmaceutical Company Limited, 1-1, Doshomachi 4-chome, Chuo-ku, Osaka-Shi, 541-0045 OSAKA, Japan (JP)
Peter Murphy, c/o Design Partners, IDA Business Park, Southern Cross Route, A98Y6WO BRAY, CO. WICKLOW, Irland (IE)
Terence Kealy, c/o Design Partners, IDA Business Park, Southern Cross Route, A98Y6WO BRAY, CO. WICKLOW, Irland (IE)
Eugene Canavan, c/o Design Partners, IDA Business Park, Southern Cross Route, A98Y6WO BRAY, CO. WICKLOW, Irland (IE)
(30) **Prioritet:** 2020.11.24, US, 29/759,591, 1, 2, 3
(55) **Designavbildninger:**

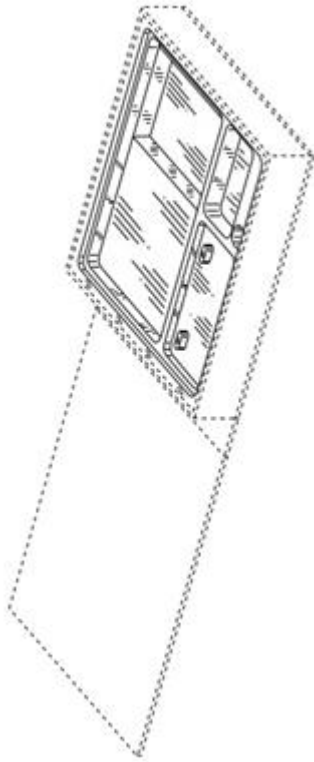

3.1

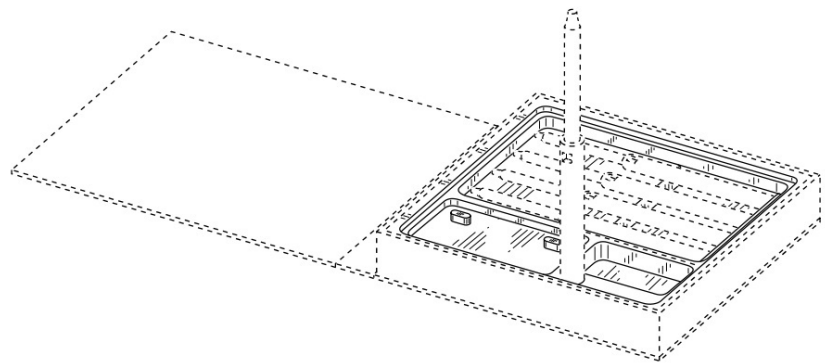

3.2

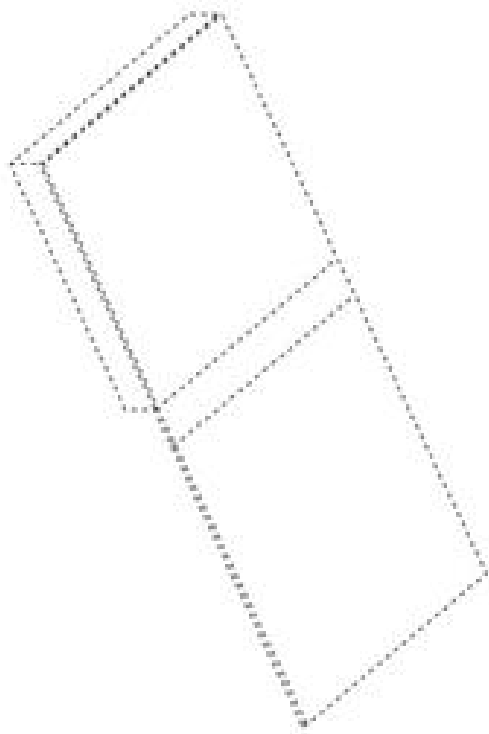

3.3



3.4

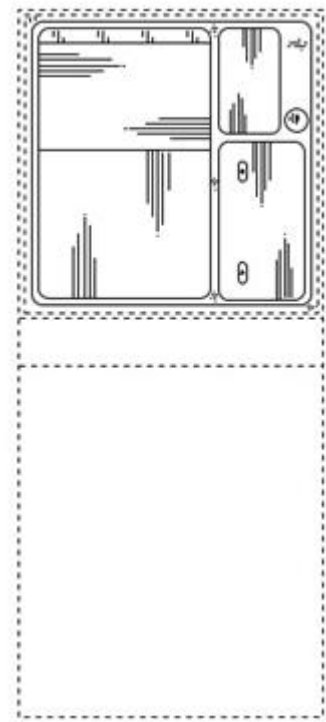

3.5



3.6

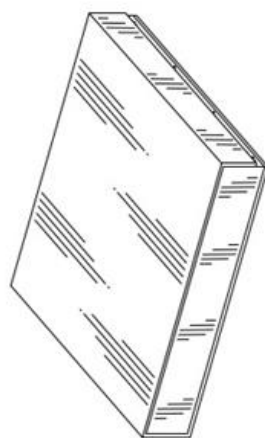

3.7

(11)	Reg.nr.:	DM/215669
(21)	Søkn.nr.:	20210804
(22)	Inngitt i WIPO:	2021.07.02
(15)	Registrert i WIPO:	2021.07.02
(24)	Løpedag:	2021.07.02
(43)	Allm. tilgj.:	2021.08.13
(15)	Besluttet gjeldende NO:	2021.09.03
(45)	Kunngjort NO:	2021.09.20
(18)	Reg. gjelder til:	2026.07.02
(73)	Innehaver:	MuteBox ApS, Orla Lehmannsgade 1A, 1., 7100 VEJLE, Danmark

Design 1

(54)	Produkt:	Cabin for holding meetings
(51)	Klasse:	06-06
(72)	Designer:	
(55)	Designavbildninger:	

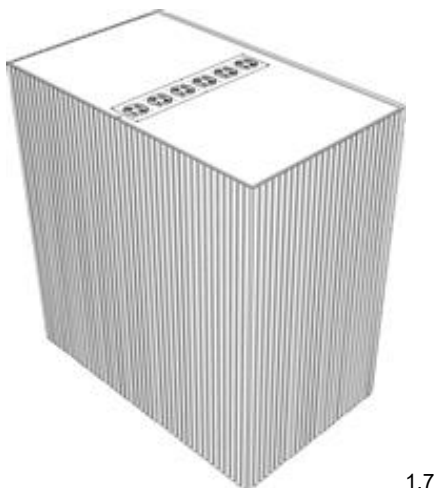
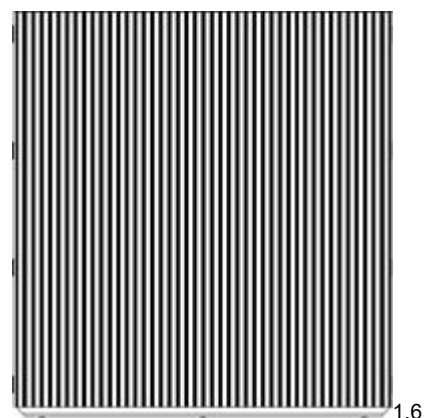
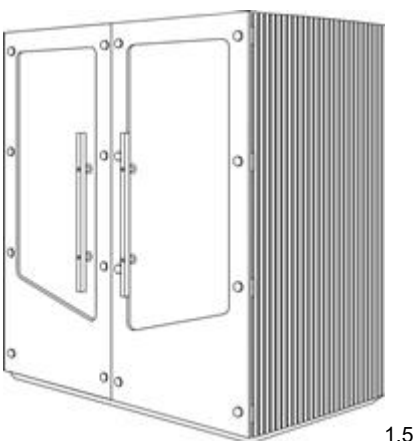
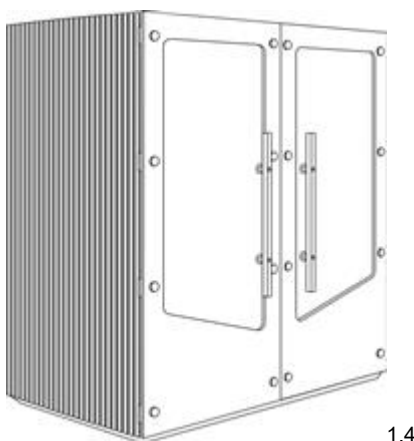
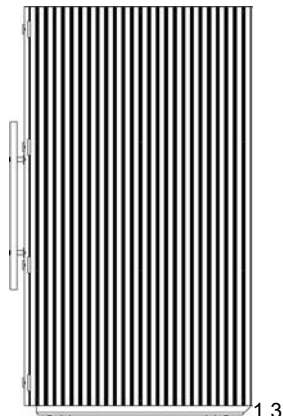
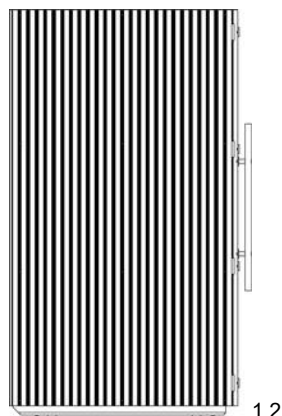
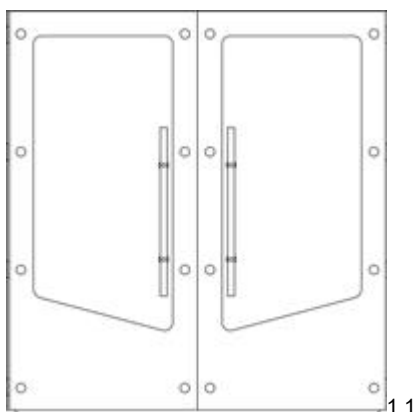

(11)	Reg.nr.:	DM/215790
(21)	Søkn.nr.:	20210879
(22)	Inngitt i WIPO:	2021.03.30
(15)	Registrert i WIPO:	2021.03.30
(24)	Løpedag:	2021.03.30
(43)	Allm. tilgj.:	2021.08.20
(15)	Besluttet gjeldende NO:	2021.09.03
(45)	Kunngjort NO:	2021.09.20
(18)	Reg. gjelder til:	2026.03.30
(73)	Innehaver:	TOMASZ KNYSAK, WYSZYNSKIEGO 75, 42-200 CZESTOCHOWA, Polen JAGODA KNYSAK, OKRZEI 94, 42-300 MYSZKÓW, Polen MARCIN KNYSAK, POKORNA 2/1010, 00-199 WARSZAWA, Polen

Design 1

(54)	Produkt:	Letter box
(51)	Klasse:	25-03
(72)	Designer:	TOMASZ KNYSAK, WYSZYNSKIEGO 75, 42-200 CZESTOCHOWA, Polen (PL) JAGODA KNYSAK, OKRZEI 94, 42-300 MYSZKÓW, Polen (PL) MARCIN KNYSAK, POKORNA 2/1010, 00-199 WARSZAWA, Polen (PL)
(30)	Prioritet:	2021.04.03, EM, 0, 1
(55)	Designavbildninger:	



1.1



1.2



1.3



1.4



1.5



1.6

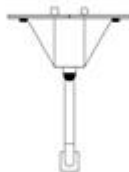

1.7

(11)	Reg.nr.:	DM/215810
(21)	Søkn.nr.:	20210869
(22)	Inngitt i WIPO:	2021.01.15
(15)	Registrert i WIPO:	2021.01.15
(24)	Løpedag:	2021.01.15
(43)	Allm. tilgj.:	2021.08.27
(15)	Besluttet gjeldende NO:	2021.08.31
(45)	Kunngjort NO:	2021.09.20
(18)	Reg. gjelder til:	2026.01.15
(73)	Innehaver:	HOPIUM S.A.S., 54/56 Avenue Hoche, 75008 PARIS, Frankrike

Design 1

(54)	Produkt:	Motorcar platform
(51)	Klasse:	12-16
(72)	Designer:	Felix Godard, 20 Rue de Princay, 86530 AVAILLES-EN-CHATELLERAULT, Frankrike (FR)
(55)	Designavbildninger:	



1.1



1.2



1.3

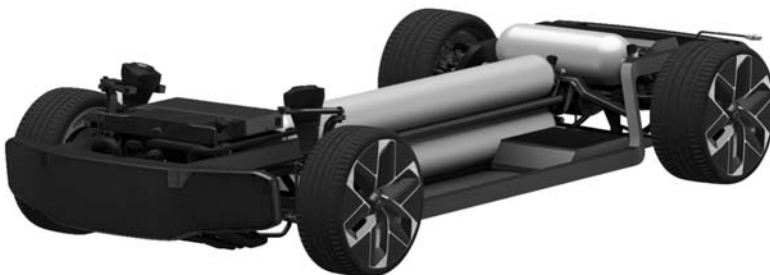

1.4



1.5

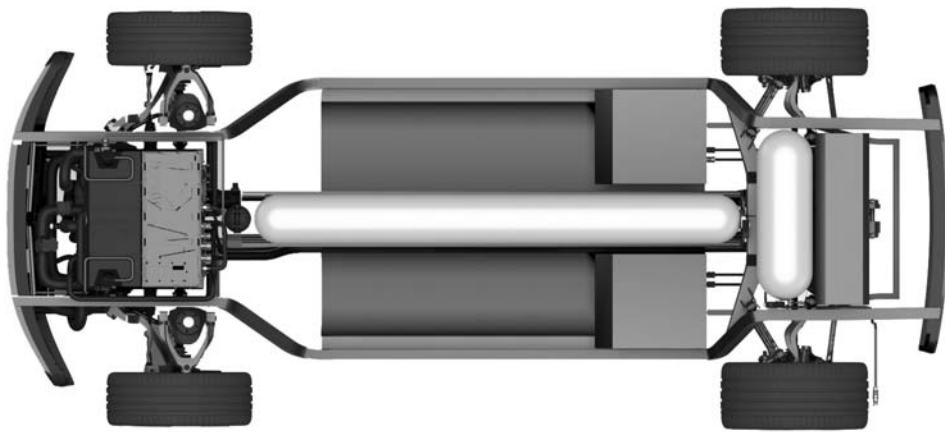

1.6



1.7

(11)	Reg.nr.:	DM/215823
(21)	Søkn.nr.:	20210870
(22)	Inngitt i WIPO:	2021.08.06
(15)	Registrert i WIPO:	2021.08.06
(24)	Løpedag:	2021.08.06
(43)	Allm. tilgj.:	2021.08.27
(15)	Besluttet gjeldende NO:	2021.08.31
(45)	Kunngjort NO:	2021.09.20
(18)	Reg. gjelder til:	2026.08.06
(73)	Innehaver:	FERRARI S.P.A., Via Emilia Est, 1163, MODENA, Italia
(50)	Anmerkninger:	Registreringen gjelder samregistrering

Design 1

(54)	Produkt:	Toy car
(51)	Klasse:	21-01
(72)	Designer:	Flavio MANZONI, c/o FERRARI S.p.A., Via Emilia Est 1163, 41100 MODENA, Italia (IT)
(30)	Prioritet:	2021.02.09, IB, WIPO101708, 1, 2, 3, 4, 5, 6
(55)	Designavbildninger:	



1.1

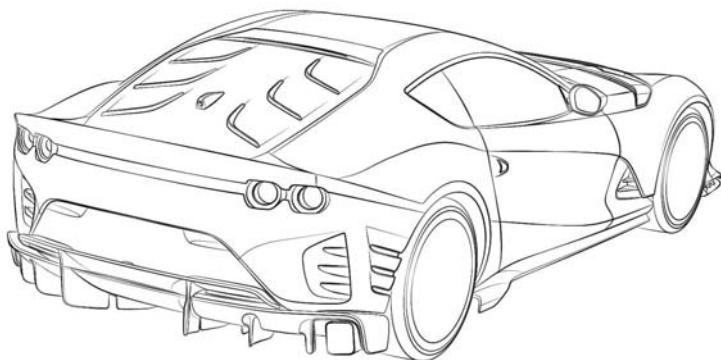

1.2

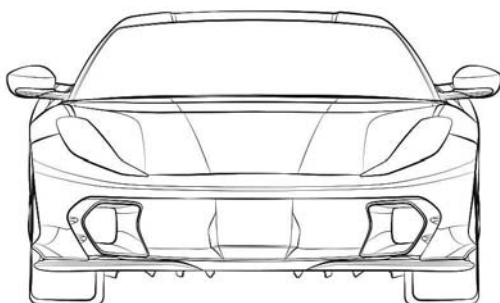

1.3

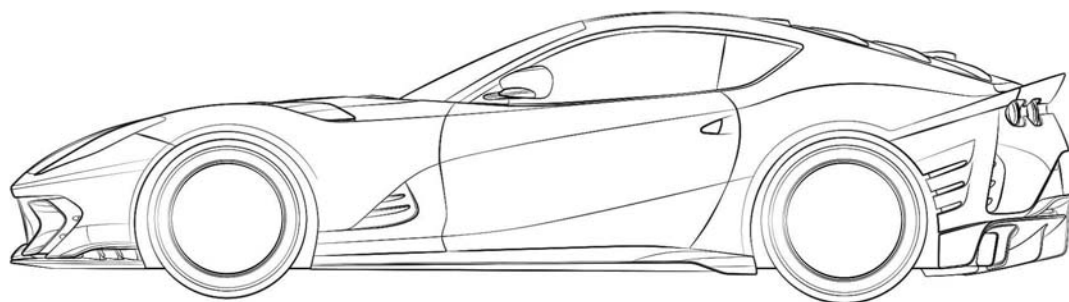

1.4

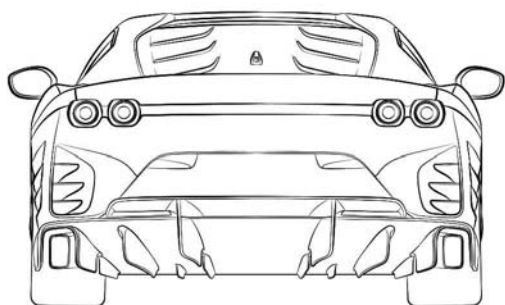

1.5

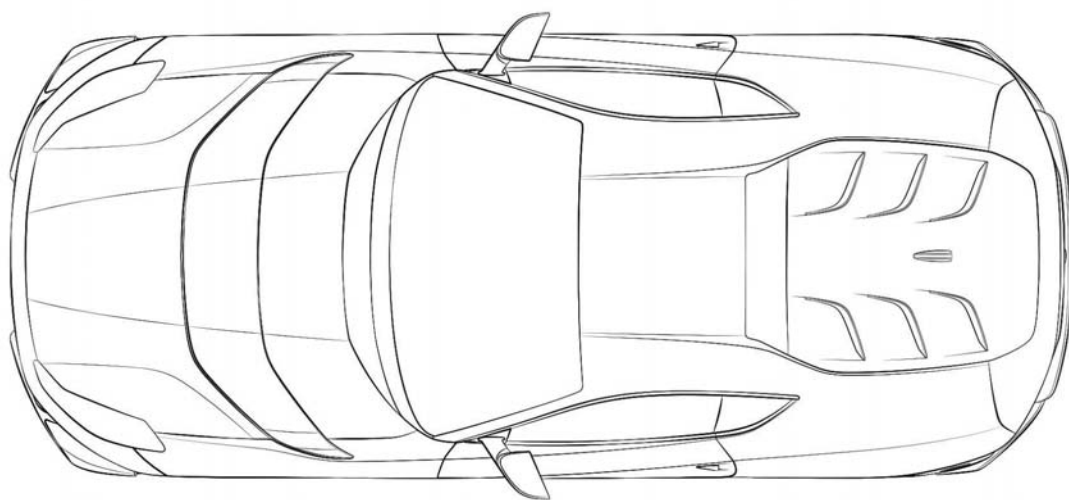

1.6

Design 2

- (54) **Produkt:** Toy car
(51) **Klasse:** 21-01
(72) **Designer:** Flavio MANZONI, c/o FERRARI S.p.A., Via Emilia Est 1163, 41100 MODENA, Italia (IT)
(30) **Prioritet:** 2021.02.09, IB, WIPO101708, 1, 2, 3, 4, 5, 6
(55) **Designavbildninger:**

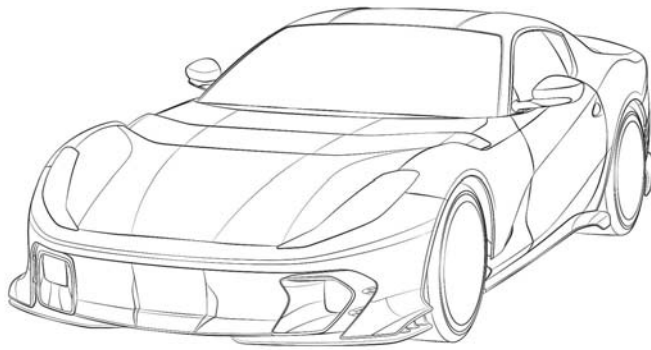

2.1

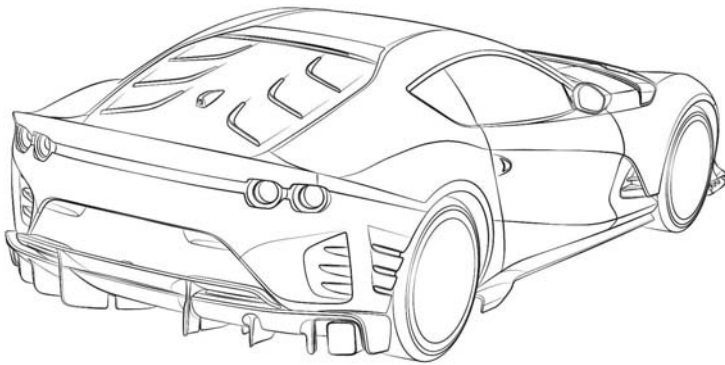

2.2

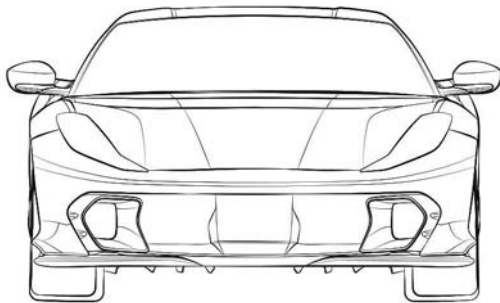

2.3

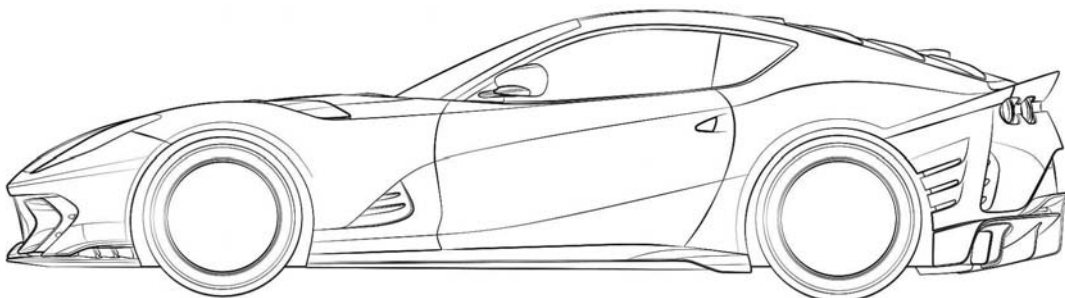

2.4

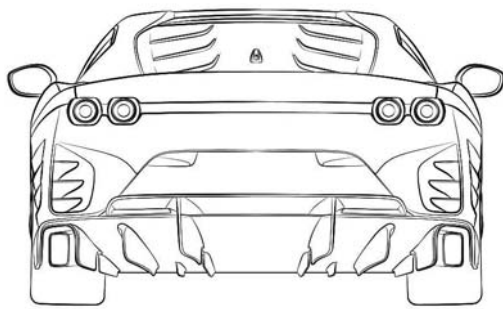

2.5

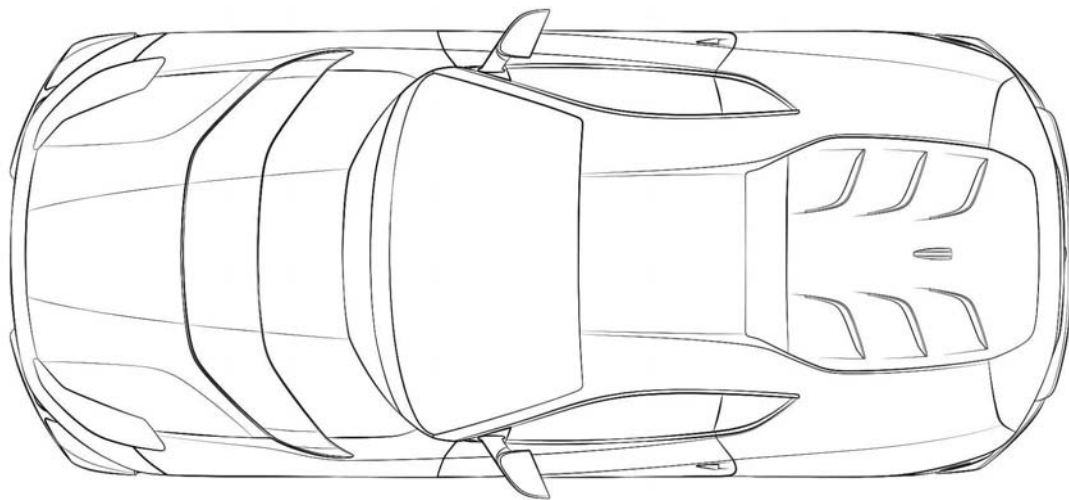

2.6

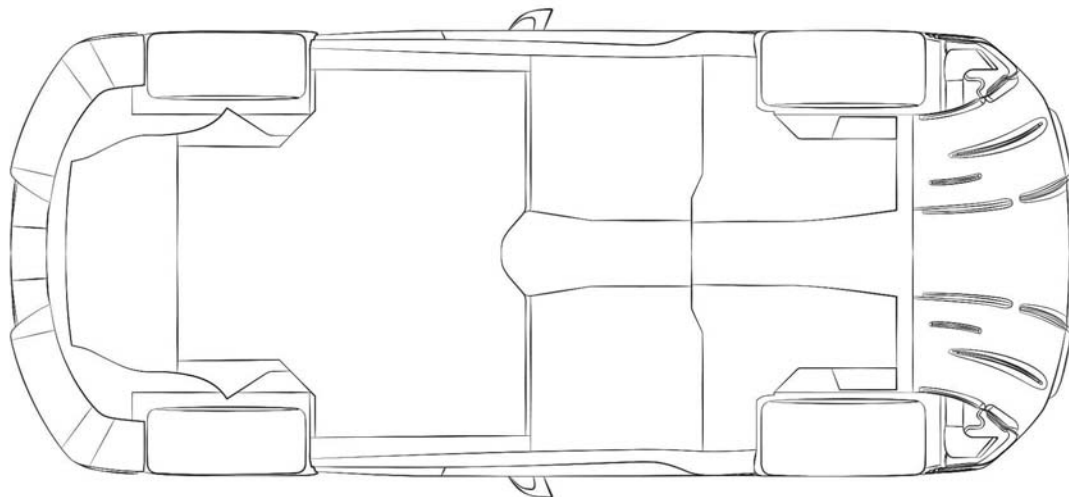

2.7

Design 3

- (54) **Produkt:** Toy car
(51) **Klasse:** 21-01
(72) **Designer:** Flavio MANZONI, c/o FERRARI S.p.A., Via Emilia Est 1163, 41100 MODENA, Italia (IT)
(30) **Prioritet:** 2021.02.09, IB, WIPO101708, 1, 2, 3, 4, 5, 6
(55) **Designavbildninger:**

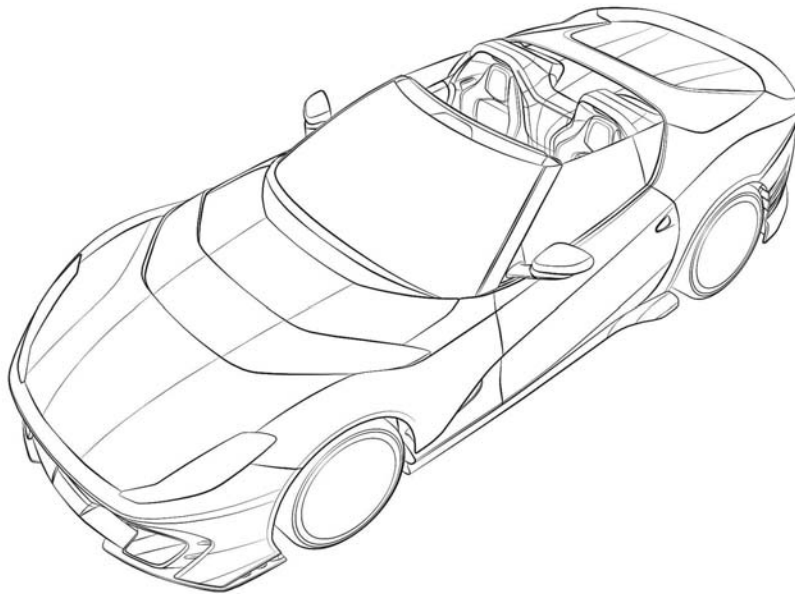

3.1

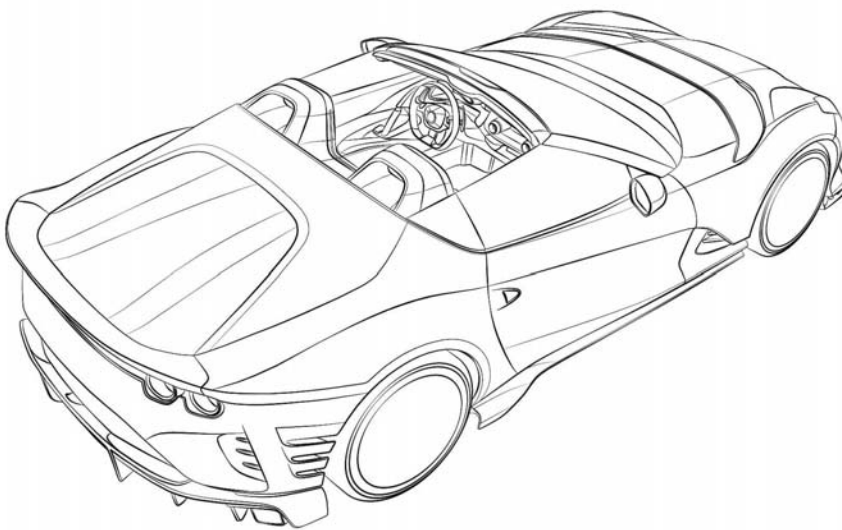

3.2

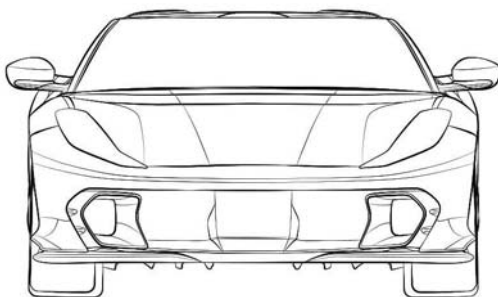

3.3

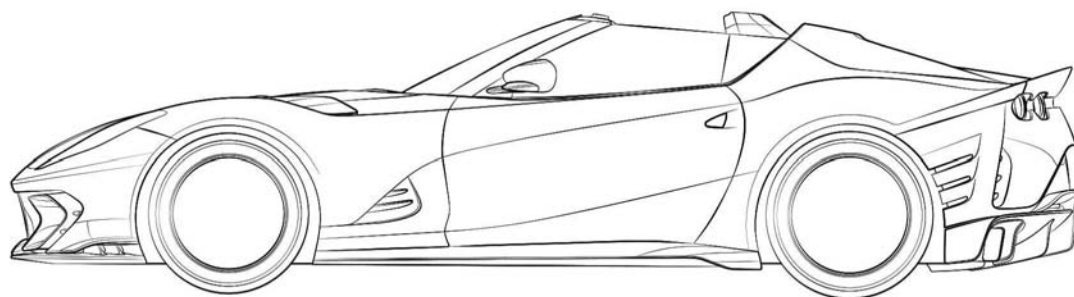

3.4

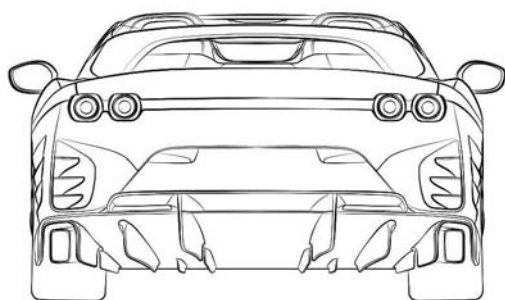

3.5

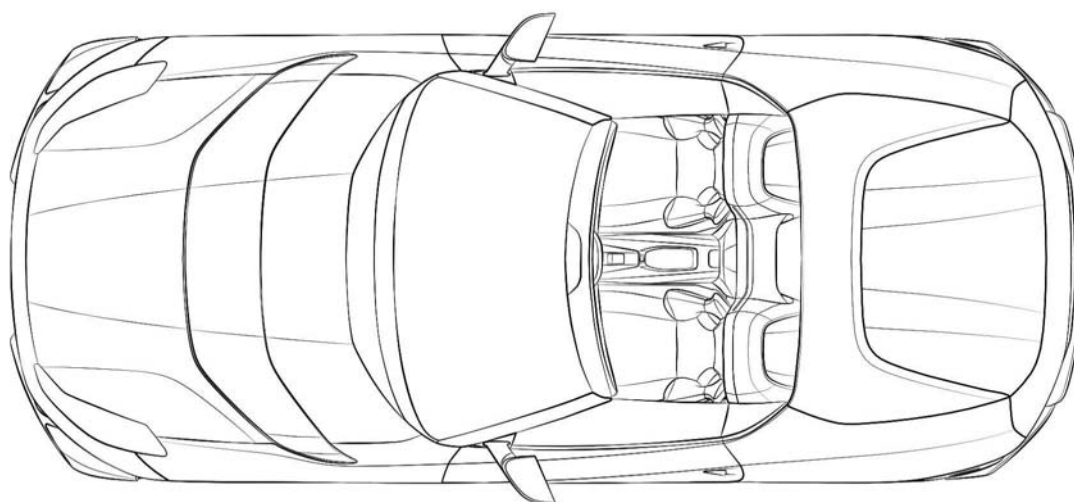

3.6

Design 4

- (54) **Produkt:** Toy car
(51) **Klasse:** 21-01
(72) **Designer:** Flavio MANZONI, c/o FERRARI S.p.A., Via Emilia Est 1163, 41100 MODENA, Italia (IT)
(30) **Prioritet:** 2021.02.09, IB, WIPO101708, 1, 2, 3, 4, 5, 6
(55) **Designavbildninger:**

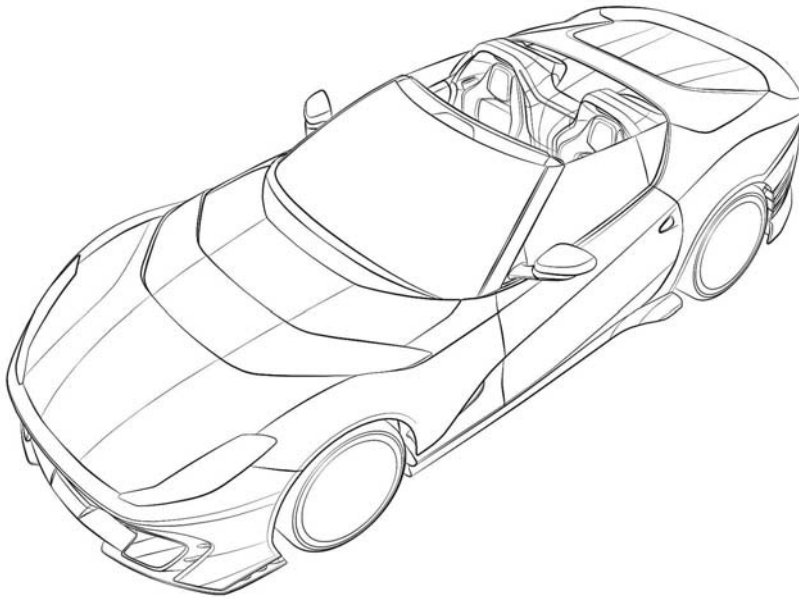

4.1

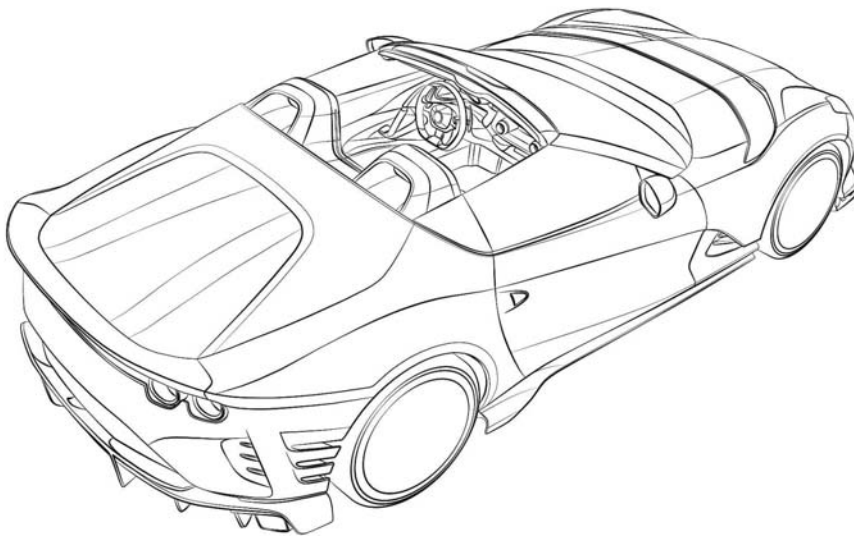

4.2

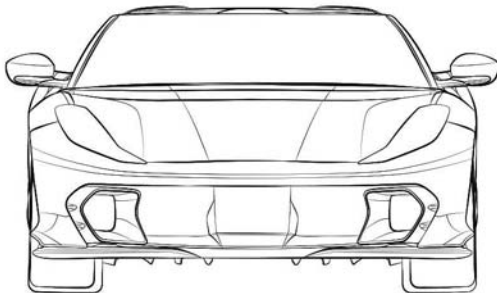

4.3

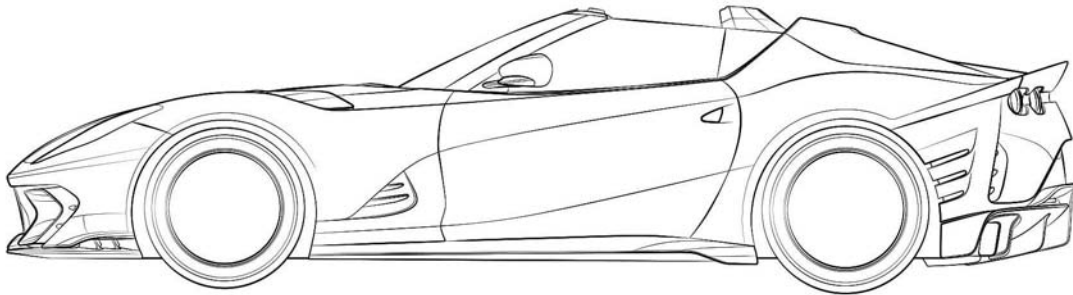

4.4

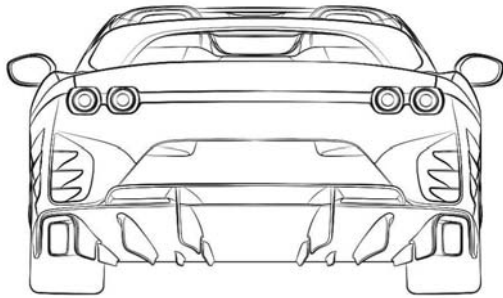

4.5

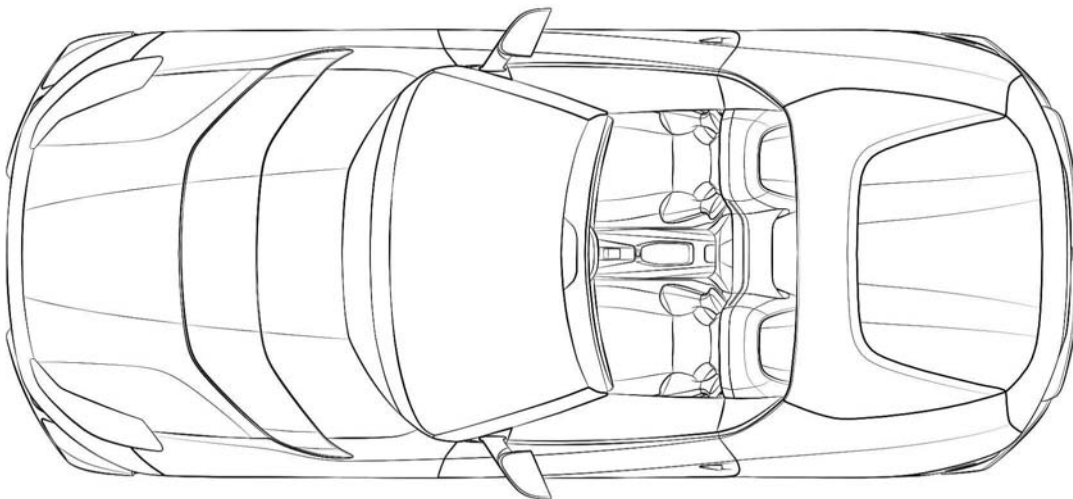

4.6

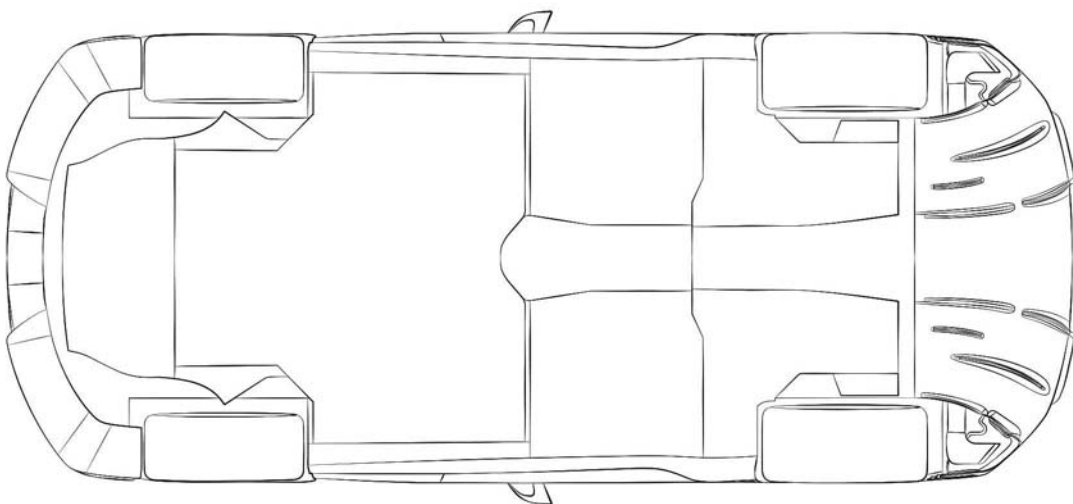

4.7

Design 5

- (54) **Produkt:** Toy car
(51) **Klasse:** 21-01
(72) **Designer:** Flavio MANZONI, c/o FERRARI S.p.A., Via Emilia Est 1163, 41100 MODENA, Italia (IT)
(30) **Prioritet:** 2021.02.09, IB, WIPO101708, 1, 2, 3, 4, 5, 6
(55) **Designavbildninger:**

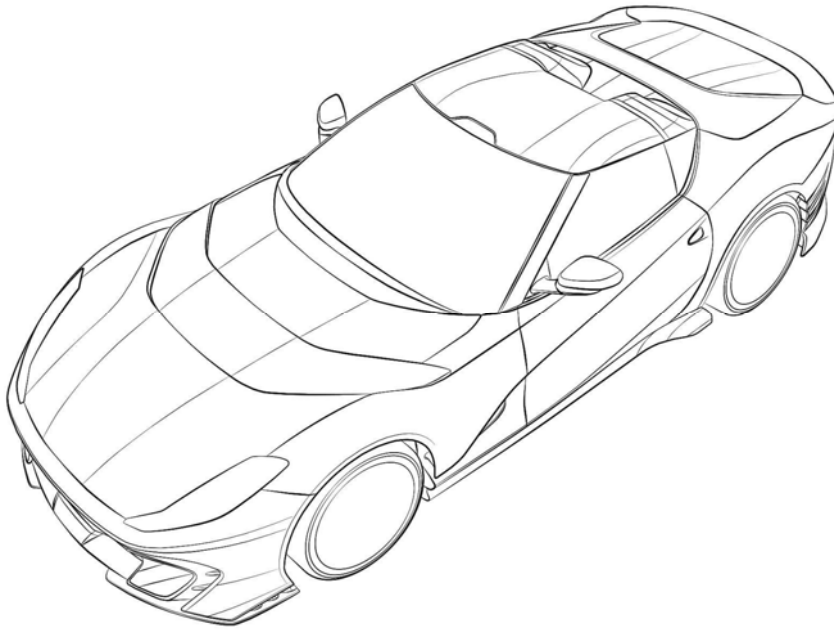

5.1

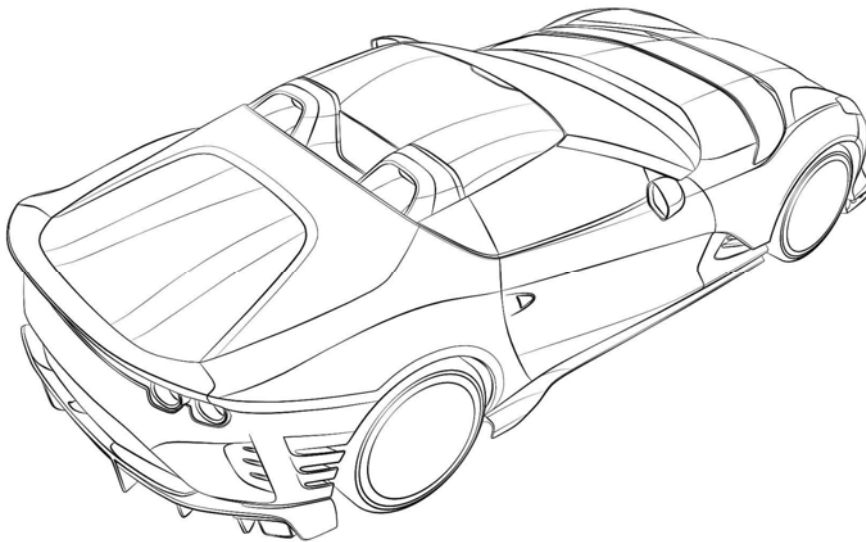

5.2

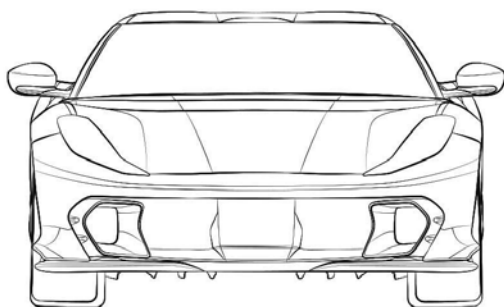

5.3

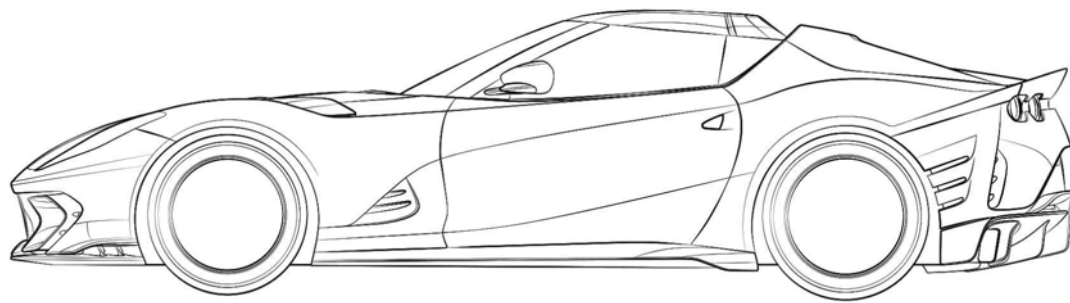

5.4

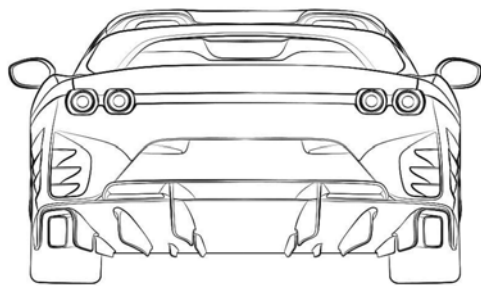

5.5

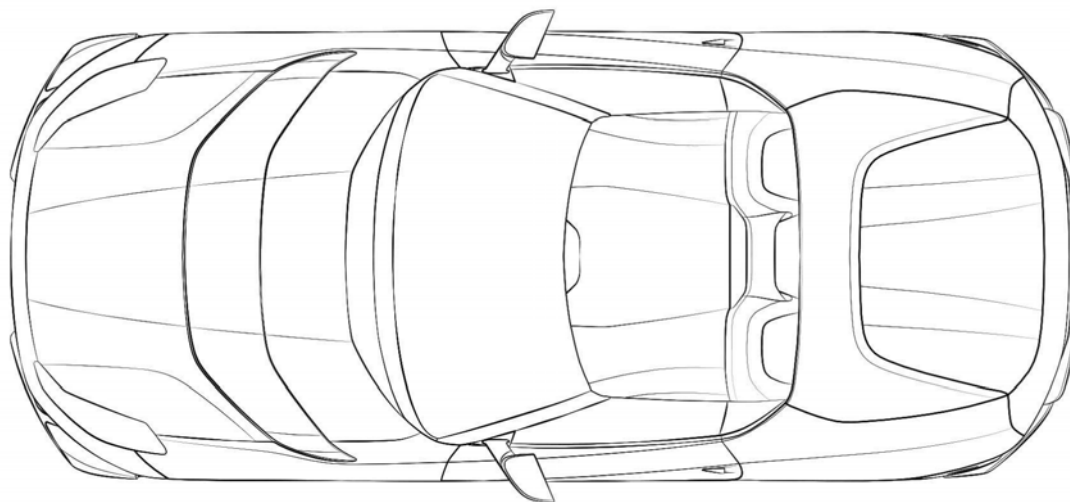

5.6

Design 6

- (54) **Produkt:** Toy car
(51) **Klasse:** 21-01
(72) **Designer:** Flavio MANZONI, c/o FERRARI S.p.A., Via Emilia Est 1163, 41100 MODENA, Italia (IT)
(30) **Prioritet:** 2021.02.09, IB, WIPO101708, 1, 2, 3, 4, 5, 6
(55) **Designavbildninger:**

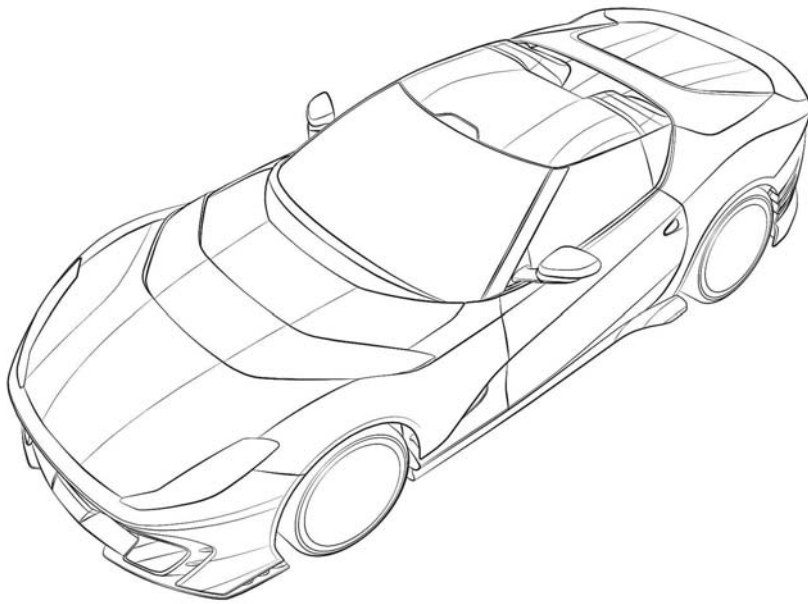

6.1

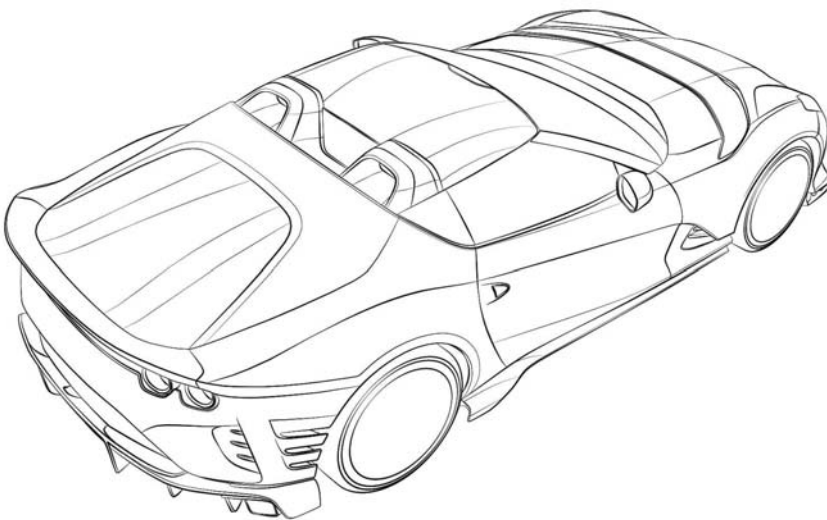

6.2

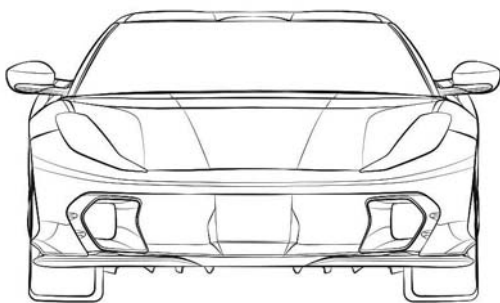

6.3

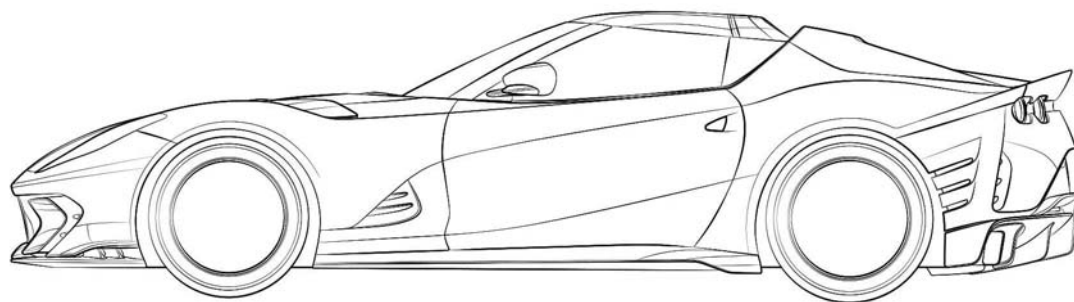

6.4

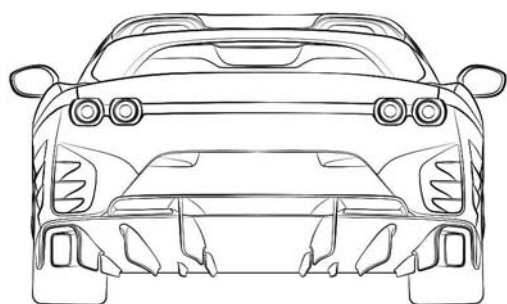

6.5

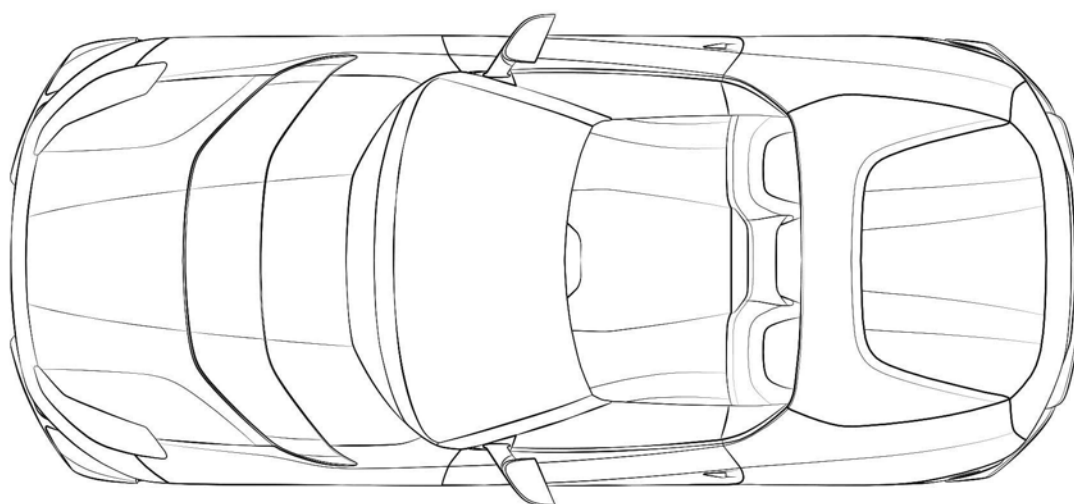

6.6

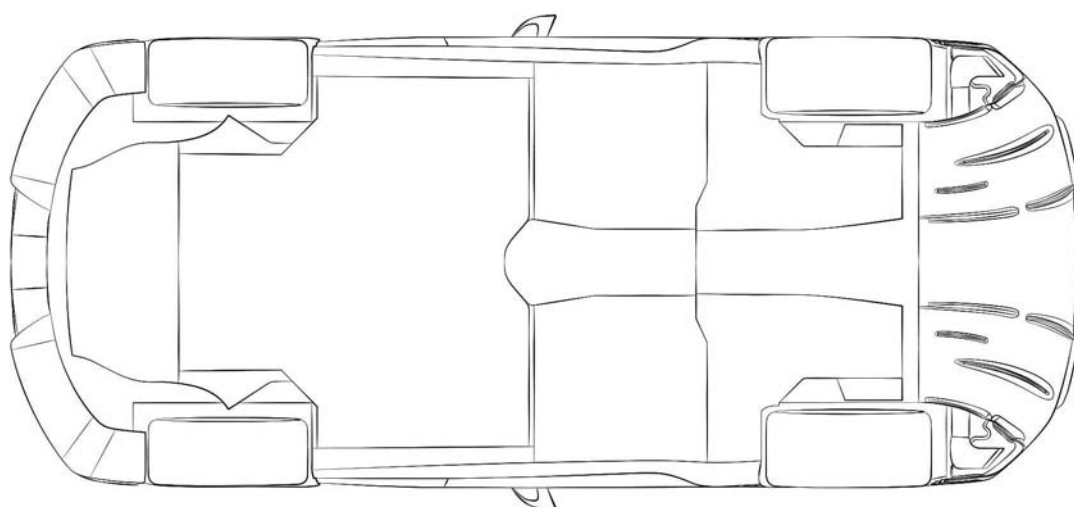

6.7

(11)	Reg.nr.:	DM/215832
(21)	Søkn.nr.:	20210871
(22)	Inngitt i WIPO:	2021.08.06
(15)	Registrert i WIPO:	2021.08.06
(24)	Løpedag:	2021.08.06
(43)	Allm. tilgj.:	2021.08.27
(15)	Besluttet gjeldende NO:	2021.08.31
(45)	Kunngjort NO:	2021.09.20
(18)	Reg. gjelder til:	2026.08.06
(73)	Innehaver:	FERRARI S.P.A., Via Emilia Est, 1163, MODENA, Italia
(50)	Anmerkninger:	Registreringen gjelder samregistrering

Design 1

(54)	Produkt:	Automobile
(51)	Klasse:	12-08
(72)	Designer:	Flavio MANZONI, c/o FERRARI S.p.A., Via Emilia Est 1163, 41100 MODENA, Italia (IT)
(30)	Prioritet:	2021.02.09, IB, WIPO101707, 1, 2, 3, 4, 5, 6
(55)	Designavbildninger:	

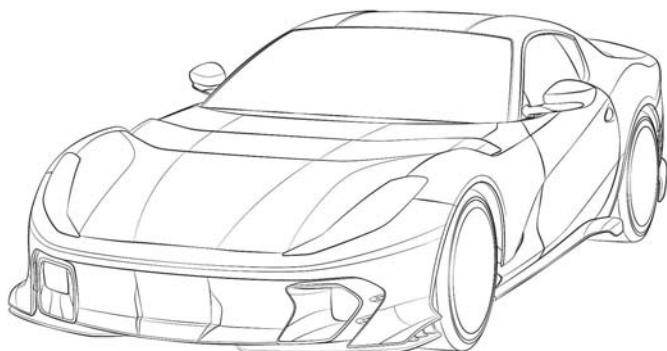

1.1

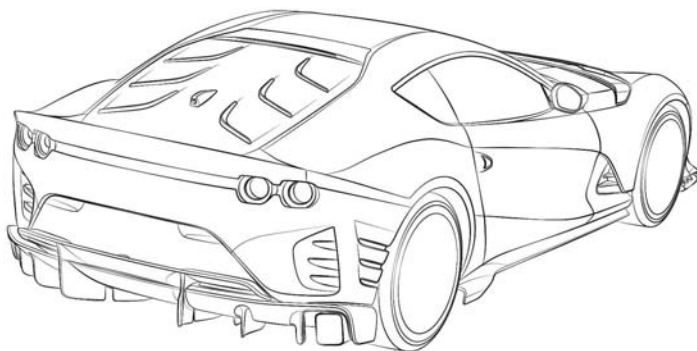

1.2

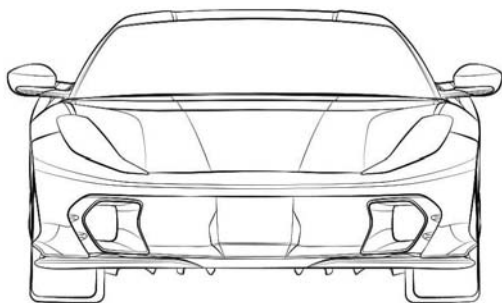

1.3

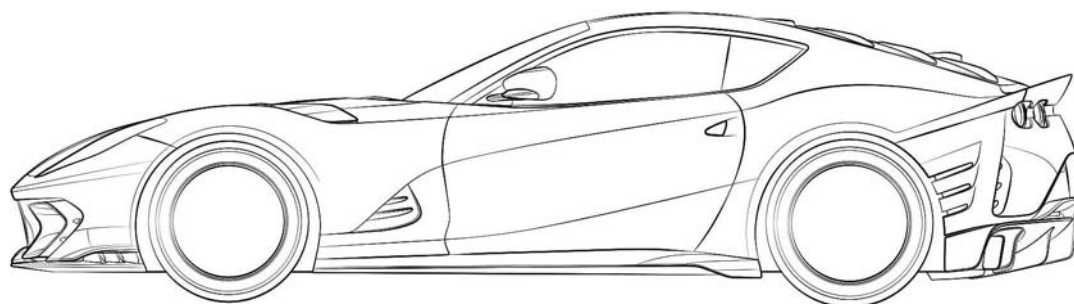

1.4

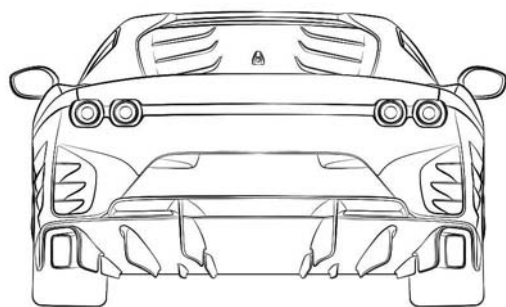

1.5

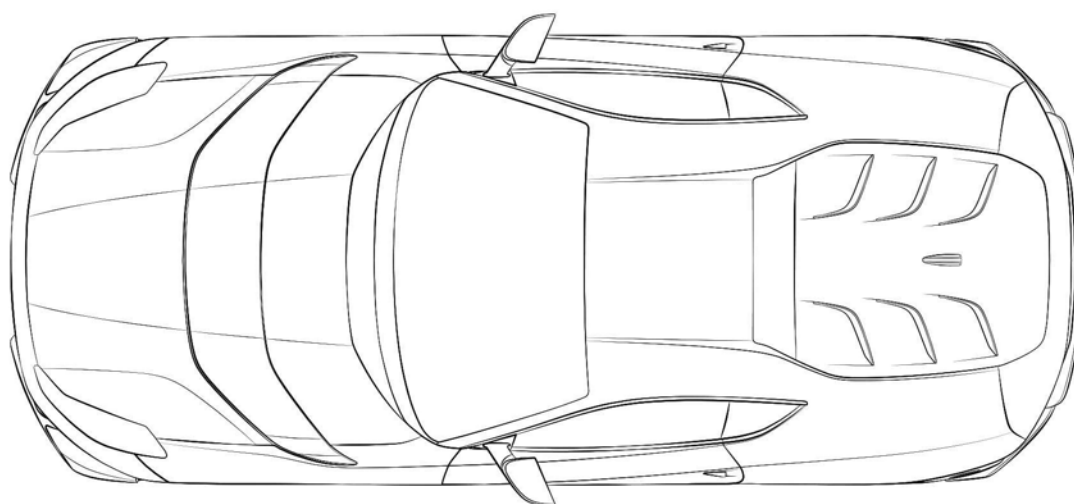

1.6

Design 2

- (54) **Produkt:** Automobile
(51) **Klasse:** 12-08
(72) **Designer:** Flavio MANZONI, c/o FERRARI S.p.A., Via Emilia Est 1163, 41100 MODENA, Italia (IT)
(30) **Prioritet:** 2021.02.09, IB, WIPO101707, 1, 2, 3, 4, 5, 6
(55) **Designavbildninger:**

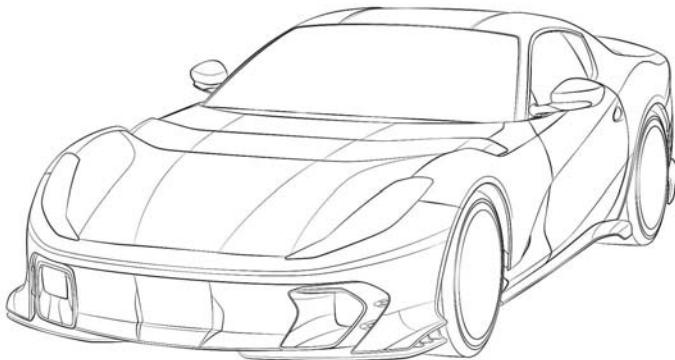

2.1

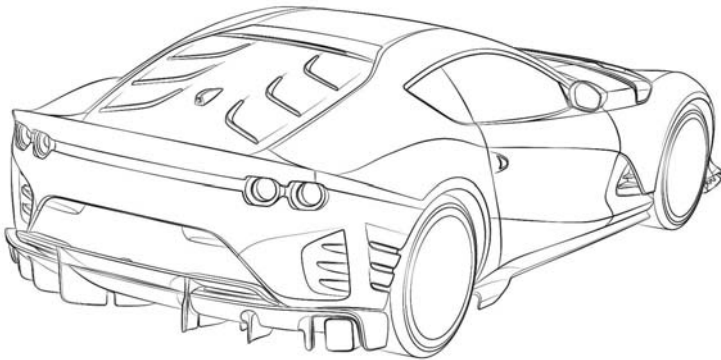

2.2

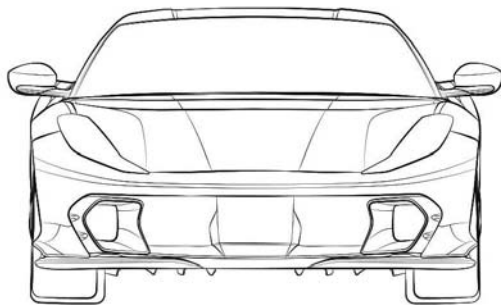

2.3

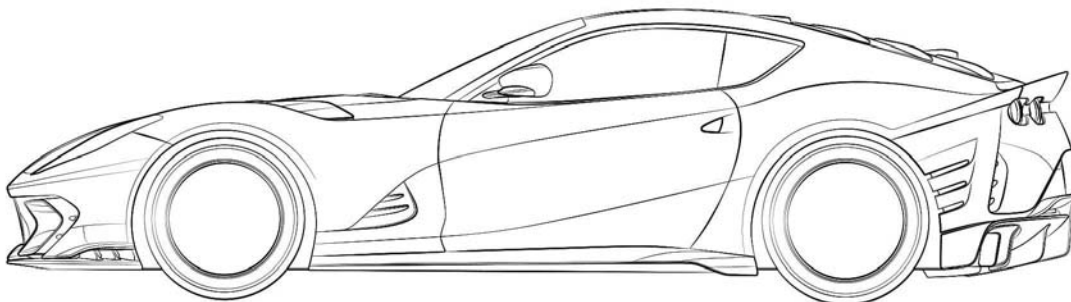

2.4

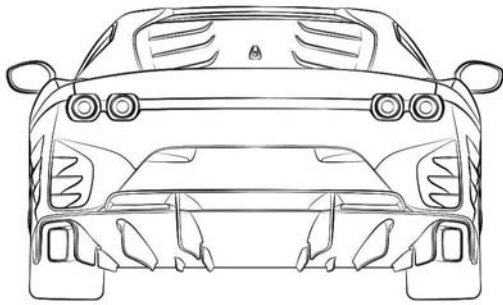

2.5

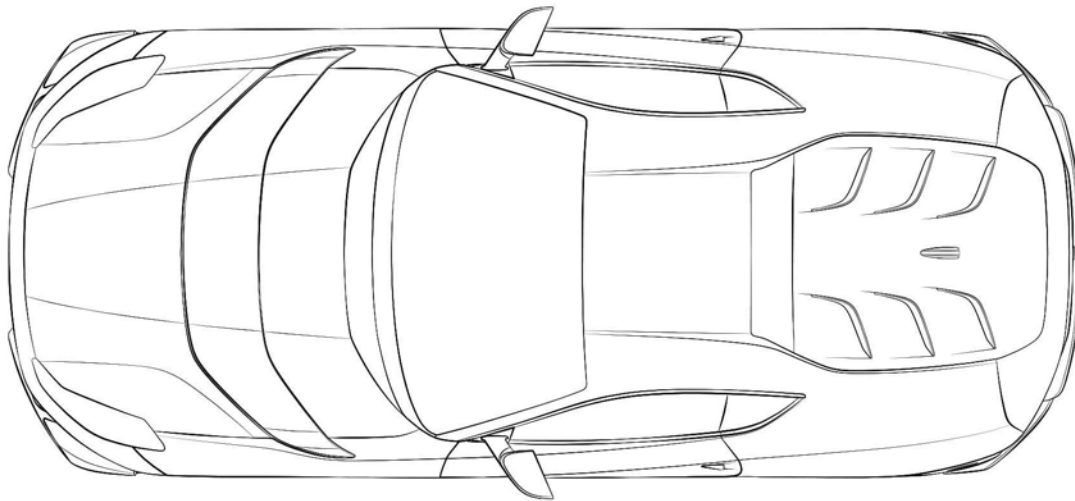

2.6

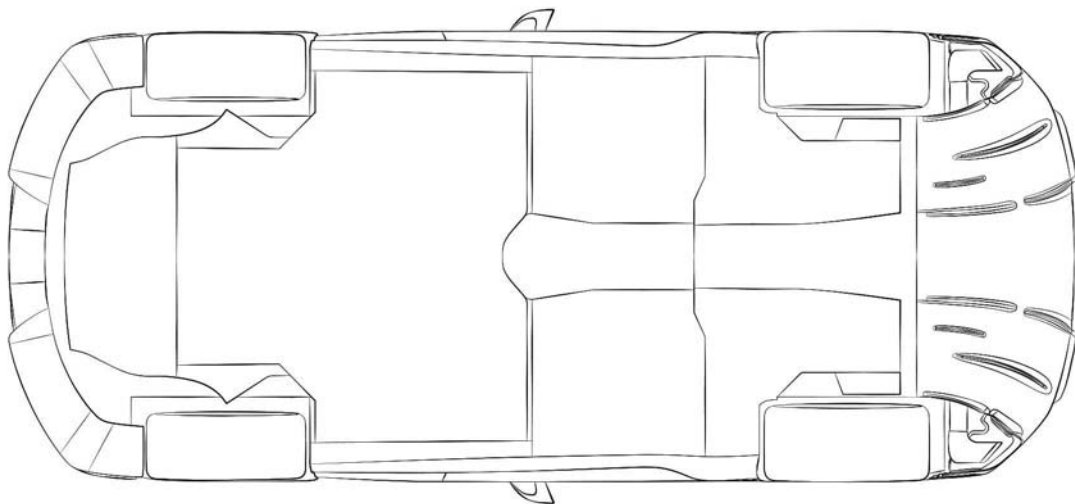

2.7

Design 3

- (54) **Produkt:** Automobile
(51) **Klasse:** 12-08
(72) **Designer:** Flavio MANZONI, c/o FERRARI S.p.A., Via Emilia Est 1163, 41100 MODENA, Italia (IT)
(30) **Prioritet:** 2021.02.09, IB, WIPO101707, 1, 2, 3, 4, 5, 6
(55) **Designavbildninger:**

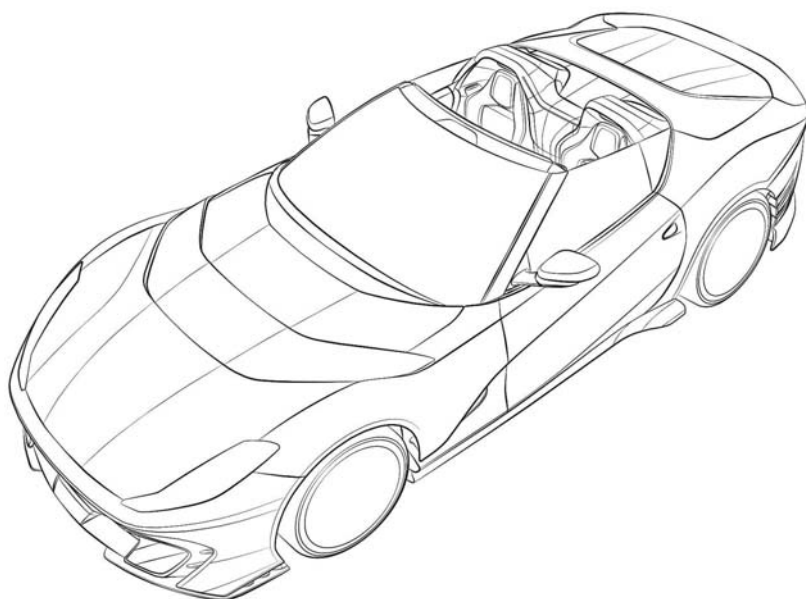

3.1

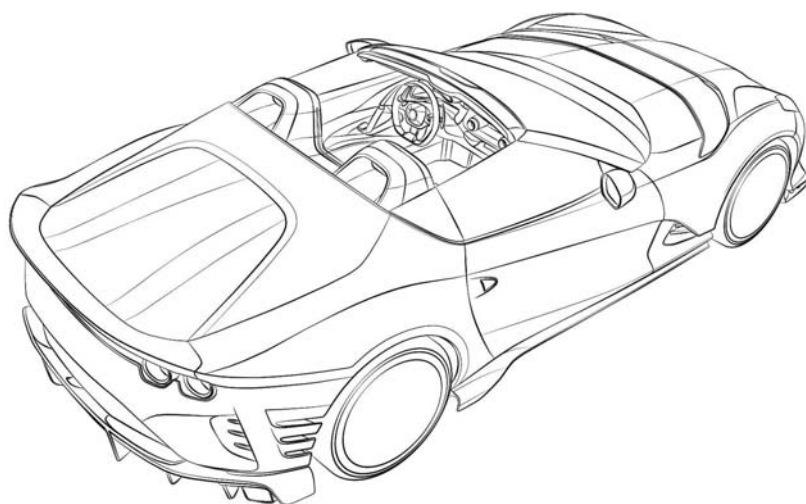

3.2

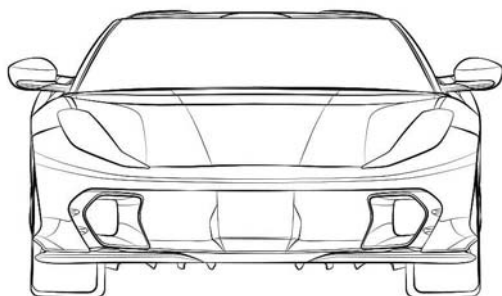

3.3

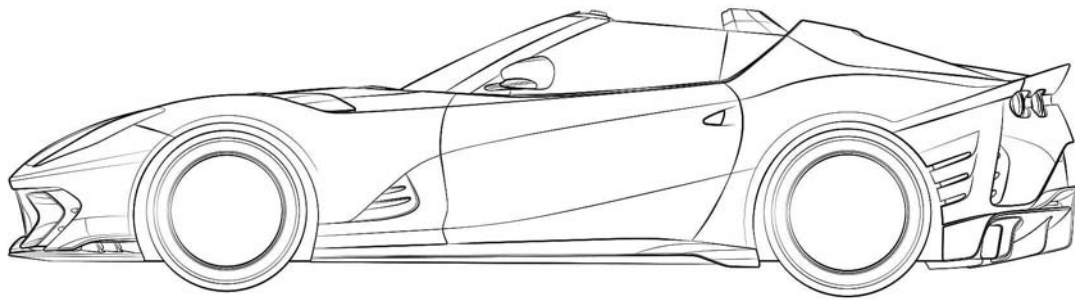

3.4

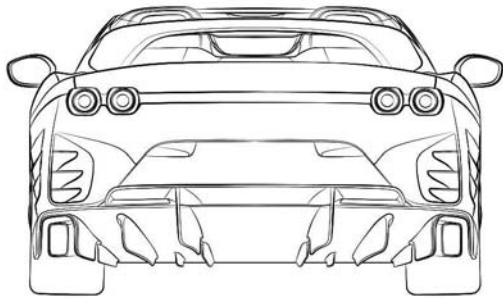

3.5

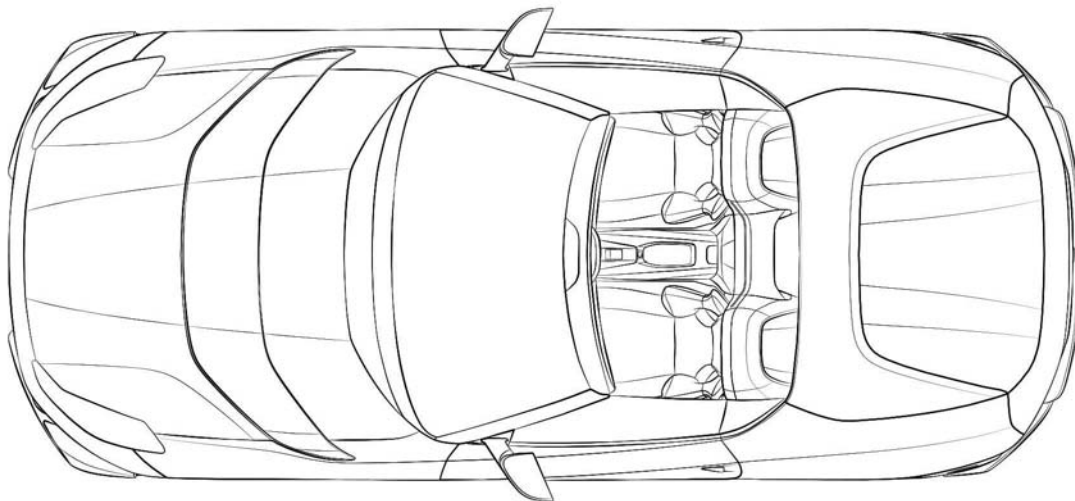

3.6

Design 4

- (54) **Produkt:** Automobile
(51) **Klasse:** 12-08
(72) **Designer:** Flavio MANZONI, c/o FERRARI S.p.A., Via Emilia Est 1163, 41100 MODENA, Italia (IT)
(30) **Prioritet:** 2021.02.09, IB, WIPO101707, 1, 2, 3, 4, 5, 6
(55) **Designavbildninger:**

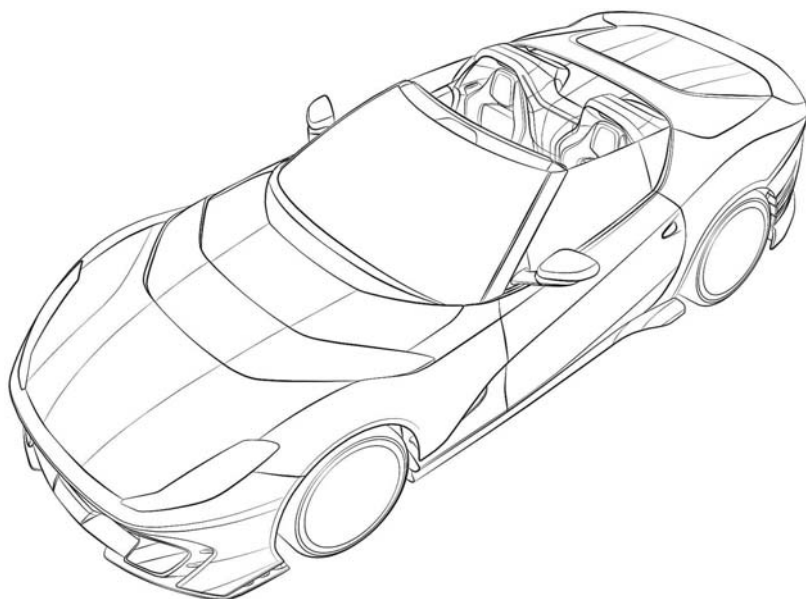

4.1

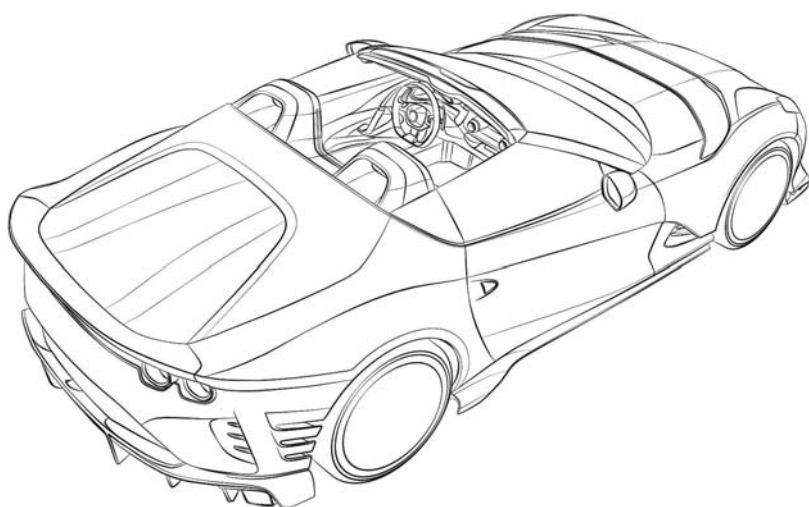

4.2

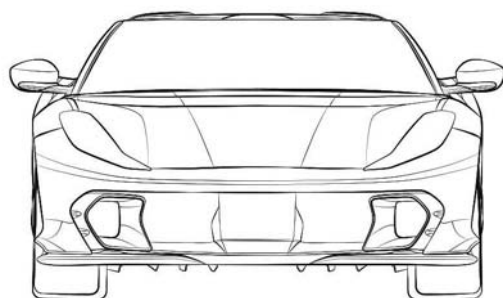

4.3

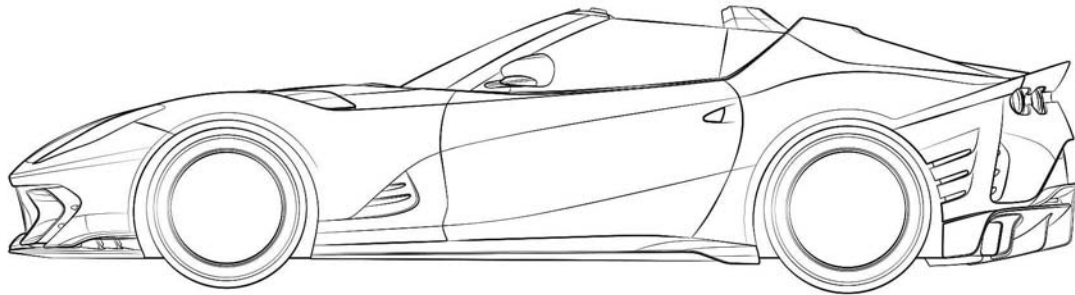

4.4

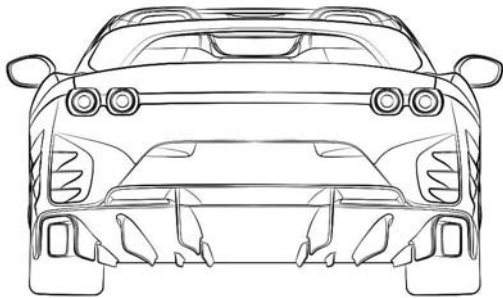

4.5

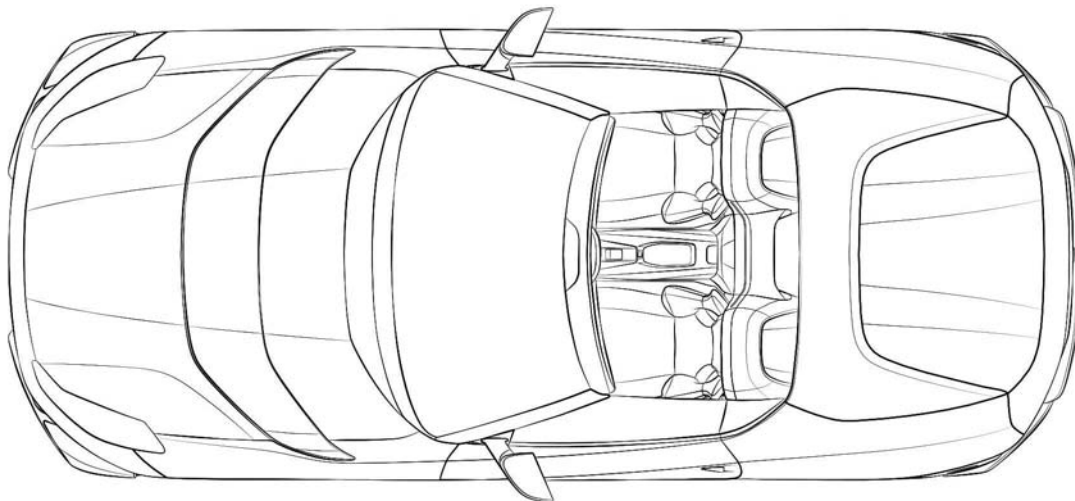

4.6

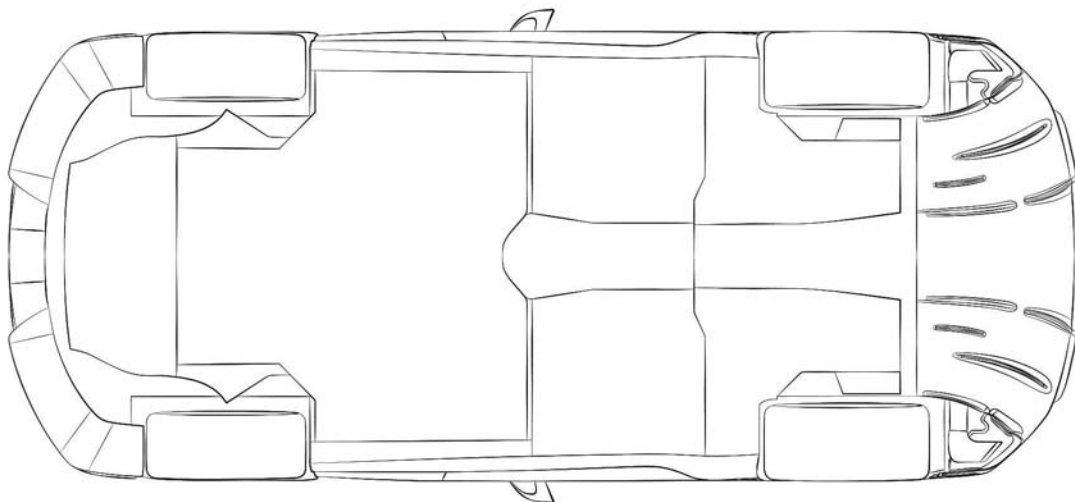

4.7

Design 5

- (54) **Produkt:** Automobile
(51) **Klasse:** 12-08
(72) **Designer:** Flavio MANZONI, c/o FERRARI S.p.A., Via Emilia Est 1163, 41100 MODENA, Italia (IT)
(30) **Prioritet:** 2021.02.09, IB, WIPO101707, 1, 2, 3, 4, 5, 6
(55) **Designavbildninger:**

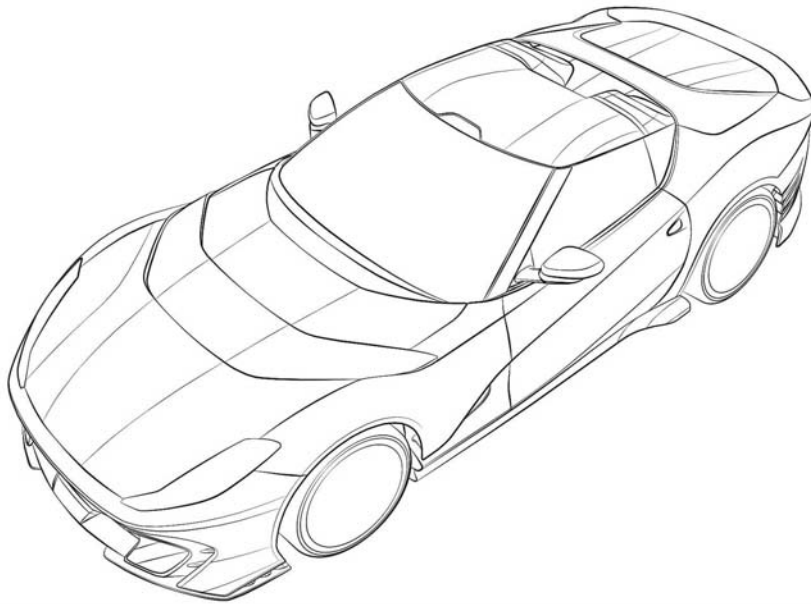

5.1

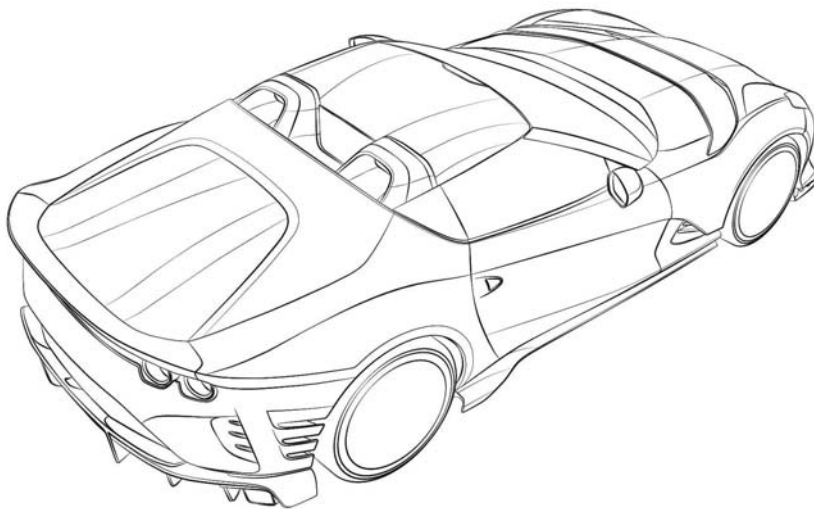

5.2

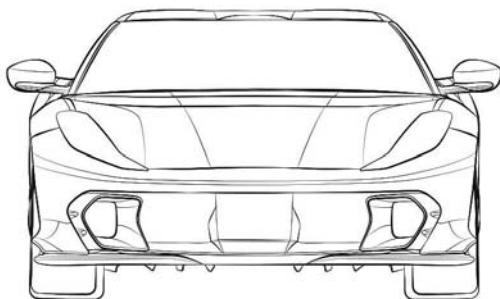

5.3

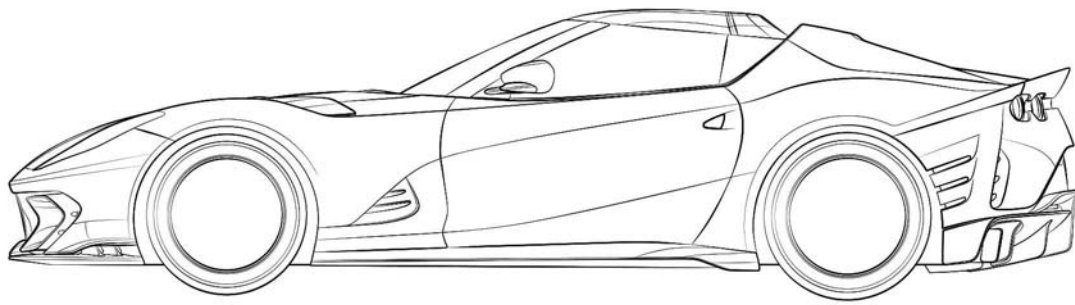

5.4

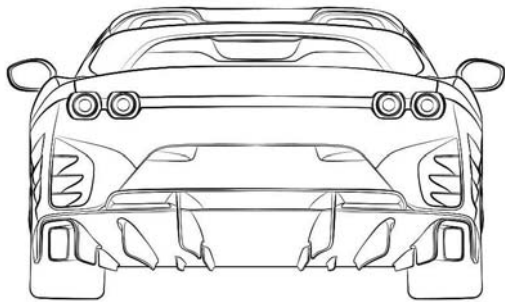

5.5

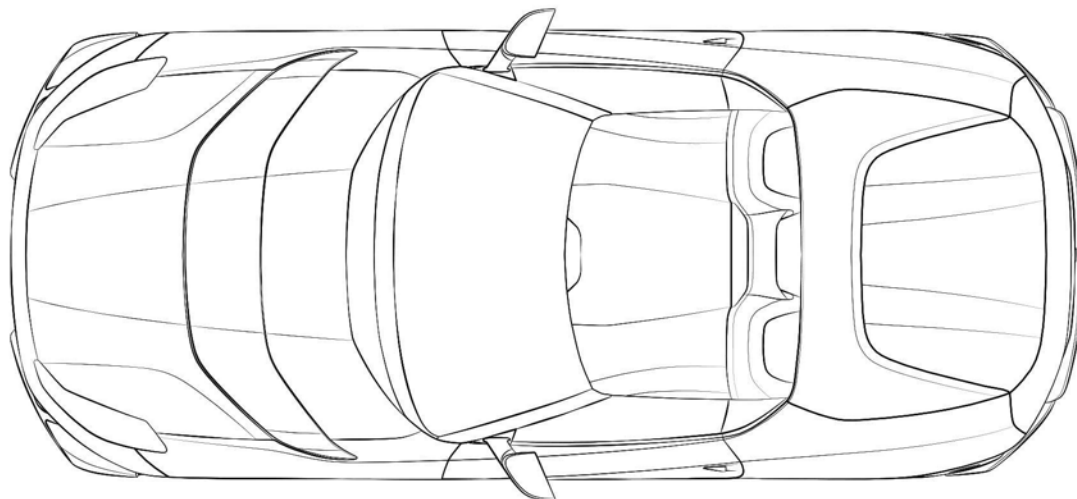

5.6

Design 6

- (54) **Produkt:** Automobile
(51) **Klasse:** 12-08
(72) **Designer:** Flavio MANZONI, c/o FERRARI S.p.A., Via Emilia Est 1163, 41100 MODENA, Italia (IT)
(30) **Prioritet:** 2021.02.09, IB, WIPO101707, 1, 2, 3, 4, 5, 6
(55) **Designavbildninger:**

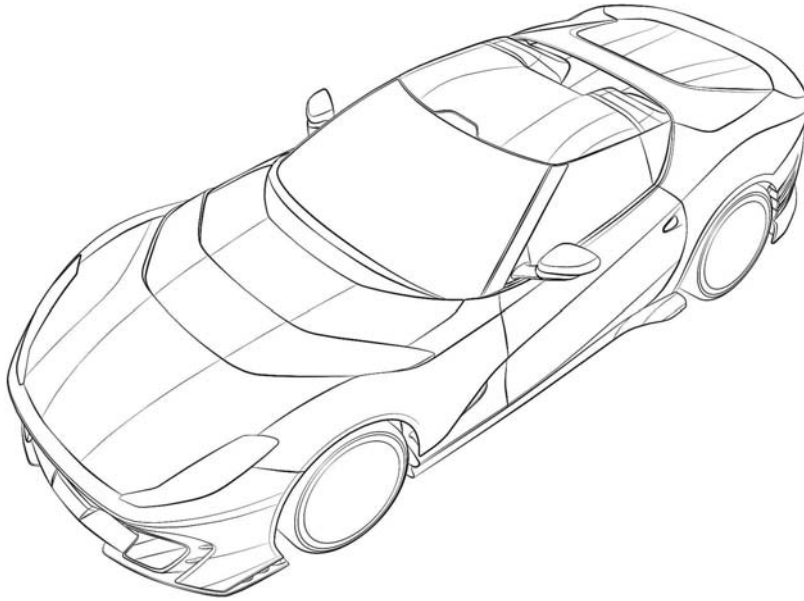

6.1

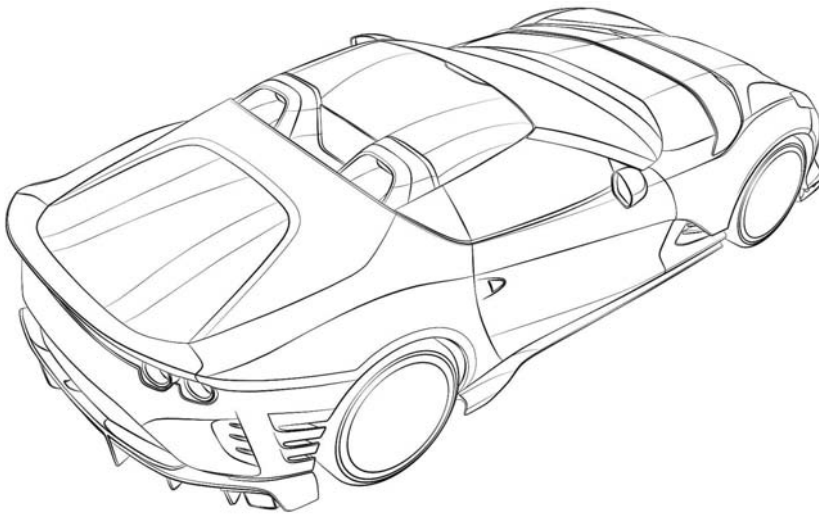

6.2

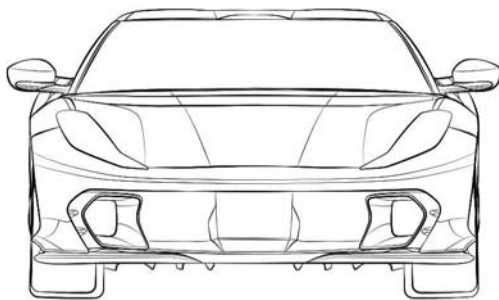

6.3

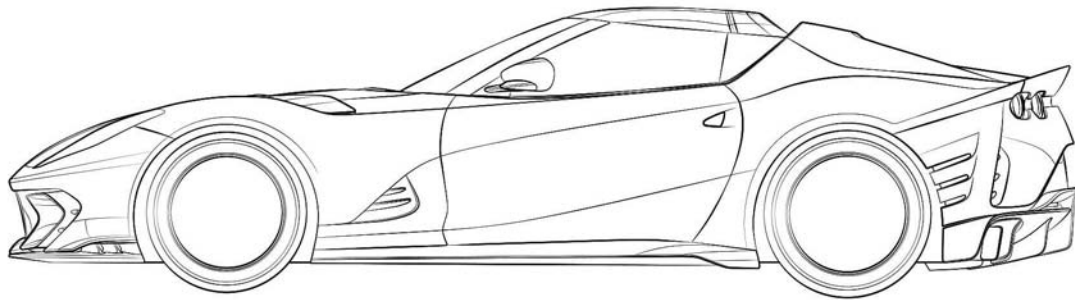

6.4

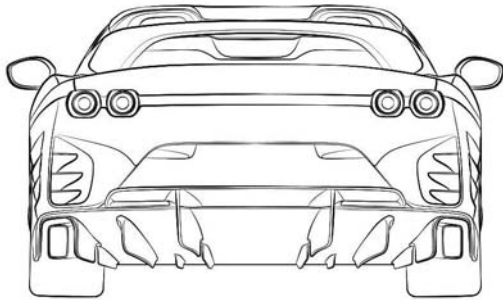

6.5

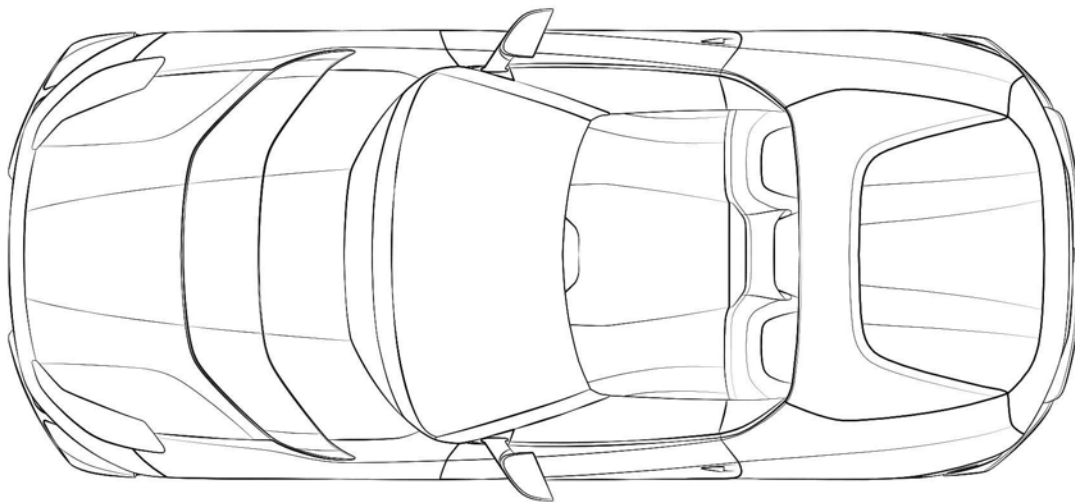

6.6

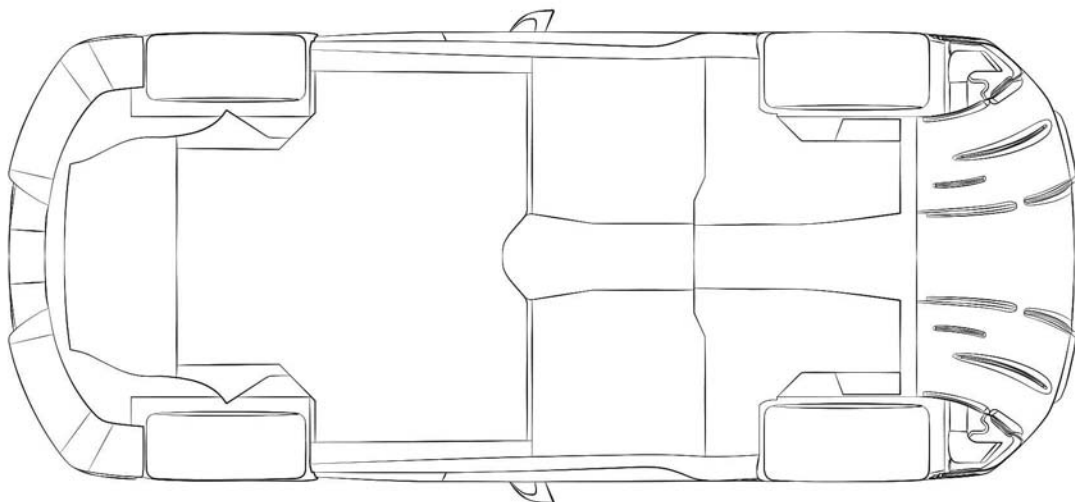

6.7

(11)	Reg.nr.:	DM/215845
(21)	Søkn.nr.:	20210872
(22)	Inngitt i WIPO:	2021.08.13
(15)	Registrert i WIPO:	2021.08.13
(24)	Løpedag:	2021.08.13
(43)	Allm. tilgj.:	2021.08.27
(15)	Besluttet gjeldende NO:	2021.09.01
(45)	Kunngjort NO:	2021.09.20
(18)	Reg. gjelder til:	2026.08.13
(73)	Innehaver:	GN Audio A/S, Lautrupbjerg 7, 2750 BALLERUP, Danmark
(50)	Anmerkninger:	Registreringen gjelder samregistrering

Design 1

(54)	Produkt:	Basic apparatus for wireless telephone
(51)	Klasse:	14-03
(72)	Designer:	Rasmus Trudslev PEDERSEN, c/o GN Audio A/S, Group IPR, Lautrupbjerg 7, 2750 BALLERUP, Danmark (DK) Philip BELLHAM, c/o GN Audio A/S, Group IPR, Lautrupbjerg 7, 2750 BALLERUP, Danmark (DK)
(55)	Designavbildninger:	



1.1



1.2



1.3

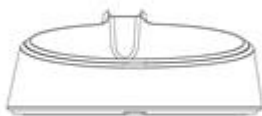

1.4



1.5



1.6

Design 2

- (54) **Produkt:** Headset for telephone (earphones and microphones combined)
(51) **Klasse:** 14-03
(72) **Designer:** Rasmus Trudslev PEDERSEN, c/o GN Audio A/S, Group IPR, Lautrupbjerg 7, 2750 BALLERUP, Danmark (DK)
Philip BELLHAM, c/o GN Audio A/S, Group IPR, Lautrupbjerg 7, 2750 BALLERUP, Danmark (DK)
- (55) **Designavbildninger:**



2.1



2.2



2.3



2.4

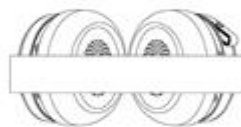

2.5



2.6



2.7

(11)	Reg.nr.:	DM/215865
(21)	Søkn.nr.:	20210873
(22)	Inngitt i WIPO:	2021.07.29
(15)	Registrert i WIPO:	2021.07.29
(24)	Løpedag:	2021.07.29
(43)	Allm. tilgj.:	2021.08.27
(15)	Besluttet gjeldende NO:	2021.09.01
(45)	Kunngjort NO:	2021.09.20
(18)	Reg. gjelder til:	2026.07.29
(73)	Innehaver:	ÜNTEL KABLOLARI SANAYI VE TICARET ANONIM SİRKETİ, Makine Organize Sanayi Bölgesi, 6.Cadde, No:4 Dilovasi, KOCAELİ, Tyrkia

Design 1

(54)	Produkt:	Mascot
(51)	Klasse:	20-99
(72)	Designer:	Ahmet Serkan Yapar, Kurtköy Mahallesi, Orhanlı Caddesi, Cihan sokak, No: 31 E Blok, Kat: 1 ,Daire: 10, Pendik İATANBUL, Tyrkia (TR)
(55)	Designavbildninger:	

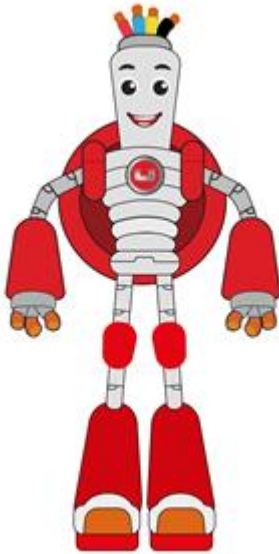

1.1

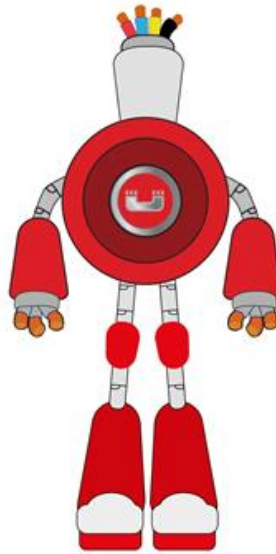

1.2

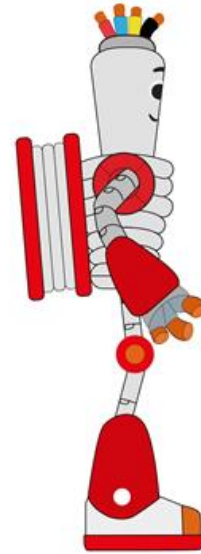

1.3

(11)	Reg.nr.:	DM/215879
(21)	Søkn.nr.:	20210874
(22)	Inngitt i WIPO:	2021.06.29
(15)	Registrert i WIPO:	2021.06.29
(24)	Løpedag:	2021.06.29
(43)	Allm. tilgj.:	2021.08.27
(15)	Besluttet gjeldende NO:	2021.09.01
(45)	Kunngjort NO:	2021.09.20
(18)	Reg. gjelder til:	2026.06.29
(73)	Innehaver:	AH License ApS, Høgevej 19, 3400 HILLERØD, Danmark

Design 1

(54)	Produkt:	Pacifier holder
(51)	Klasse:	24-04
(72)	Designer:	Henrik Larsen, Gøgevangen 12 Gadevang, 3400 HILLERØD, Danmark (DK)
(55)	Designavbildninger:	



1.1



1.2



1.3



1.4



1.5



1.6



1.7



1.8



1.9



1.10



1.11



1.12



1.13



1.14



1.15

(11)	Reg.nr.:	DM/215897
(21)	Søkn.nr.:	20210875
(22)	Inngitt i WIPO:	2021.06.29
(15)	Registrert i WIPO:	2021.06.29
(24)	Løpedag:	2021.06.29
(43)	Allm. tilgj.:	2021.08.27
(15)	Besluttet gjeldende NO:	2021.09.01
(45)	Kunngjort NO:	2021.09.20
(18)	Reg. gjelder til:	2026.06.29
(73)	Innehaver:	AH License ApS, Høgevej 19, 3400 HILLERØD, Danmark
(50)	Anmerkninger:	Registreringen gjelder samregistrering

Design 1

(54)	Produkt:	Construction set for children
(51)	Klasse:	21-01
(72)	Designer:	Henrik Larsen, Gøgevangen 12 Gadevang, 3400 HILLERØD, Danmark (DK)
(30)	Prioritet:	2021.05.28, EM, 008556898, 1, 2, 3, 4, 5
(55)	Designavbildninger:	

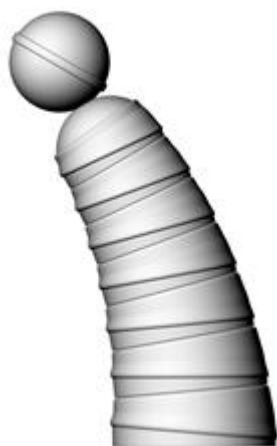

1.1



1.2



1.3



1.4



1.5



1.6



1.7

Design 2

(54) **Produkt:** Construction set for children
(51) **Klasse:** 21-01
(72) **Designer:** Henrik Larsen, Gøgevænget 12 Gadevang, 3400 HILLERØD, Danmark (DK)
(30) **Prioritet:** 2021.05.28, EM, 008556898, 1, 2, 3, 4, 5
(55) **Designavbildninger:**



2.1



2.2



2.3



2.4



2.5



2.6



2.7

Design 3

(54) **Produkt:** Construction set for children
 (51) **Klasse:** 21-01
 (72) **Designer:** Henrik Larsen, Gøgevangen 12 Gadevang, 3400 HILLERØD, Danmark (DK)
 (30) **Prioritet:** 2021.05.28, EM, 008556898, 1, 2, 3, 4, 5
 (55) **Designavbildninger:**



3.1



3.2

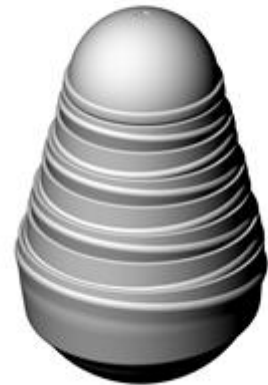

3.3

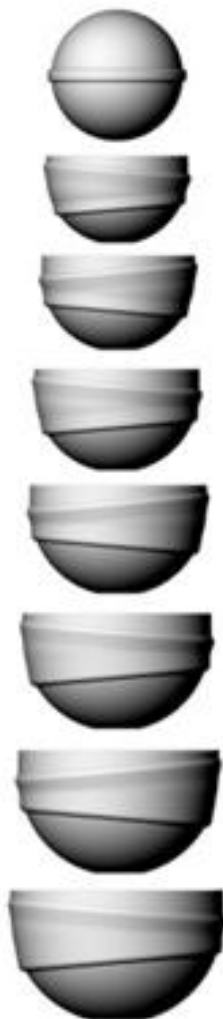

3.4

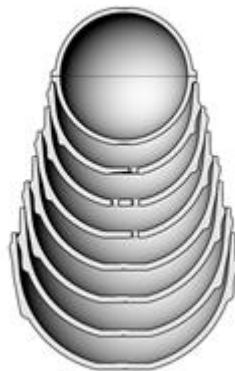

3.5

3.6

Design 4

(54) **Produkt:** Construction set for children
 (51) **Klasse:** 21-01
 (72) **Designer:** Henrik Larsen, Gøgevænget 12 Gadevang, 3400 HILLERØD, Danmark (DK)
 (30) **Prioritet:** 2021.05.28, EM, 008556898, 1, 2, 3, 4, 5
 (55) **Designavbildninger:**



4.1



4.2



4.3

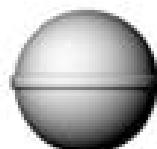

4.4

4.5

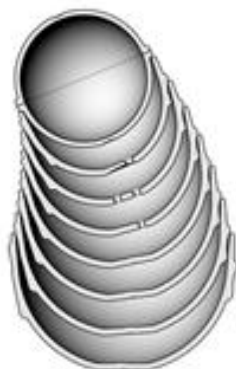

Design 5

(54) **Produkt:** Construction set for children
(51) **Klasse:** 21-01
(72) **Designer:** Henrik Larsen, Gøgevangen 12 Gadevang, 3400 HILLERØD, Danmark (DK)
(30) **Prioritet:** 2021.05.28, EM, 008556898, 1, 2, 3, 4, 5
(55) **Designavbildninger:**

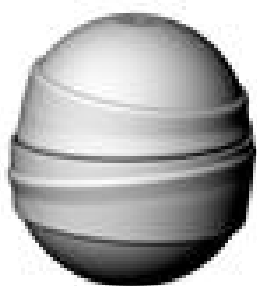

5.1



5.2

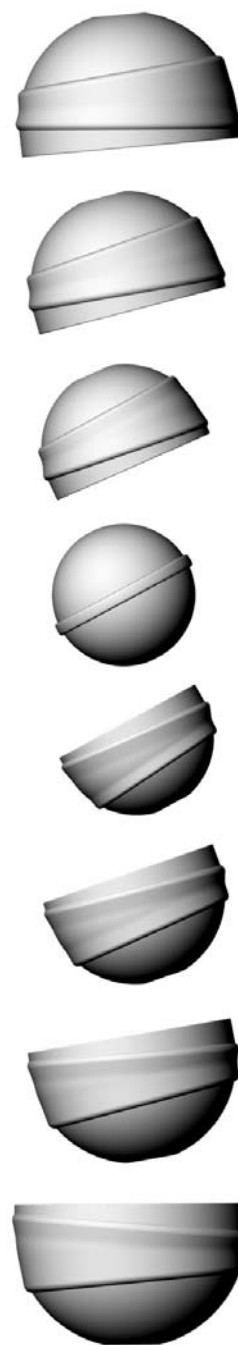

5.3

(11)	Reg.nr.:	DM/215924
(21)	Søkn.nr.:	20210876
(22)	Inngitt i WIPO:	2021.08.12
(15)	Registrert i WIPO:	2021.08.12
(24)	Løpedag:	2021.08.12
(43)	Allm. tilgj.:	2021.08.27
(15)	Besluttet gjeldende NO:	2021.09.01
(45)	Kunngjort NO:	2021.09.20
(18)	Reg. gjelder til:	2026.08.12
(73)	Innehaver:	Bodylab ApS, Plastvænget 3 D, 9560 HADSUND, Danmark
(50)	Anmerkninger:	Registreringen gjelder samregistrering

Design 1

(54)	Produkt:	Ornamentation
(51)	Klasse:	32-00
(72)	Designer:	Carl Du Rietz, Jakobsgatan 6, 2nd floor, 11480 STOCKHOLM, Sverige (SE) Dag Forsberg, Jakobsgatan 6, 2nd floor, 11480 STOCKHOLM, Sverige (SE) Linus Östberg, Jakobsgatan 6, 2nd floor, 11480 STOCKHOLM, Sverige (SE) Ka Man Chan, Jakobsgatan 6, 2nd floor, 11480 STOCKHOLM, Sverige (SE)
(55)	Designavbildninger:	



1.1

Design 2

(54)	Produkt:	Ornamentation
(51)	Klasse:	32-00
(72)	Designer:	Carl Du Rietz, Jakobsgatan 6, 2nd floor, 11480 STOCKHOLM, Sverige (SE) Dag Forsberg, Jakobsgatan 6, 2nd floor, 11480 STOCKHOLM, Sverige (SE) Linus Östberg, Jakobsgatan 6, 2nd floor, 11480 STOCKHOLM, Sverige (SE) Ka Man Chan, Jakobsgatan 6, 2nd floor, 11480 STOCKHOLM, Sverige (SE)
(55)	Designavbildninger:	



2.1

Design 3

- (54) **Produkt:** Ornamentation
(51) **Klasse:** 32-00
(72) **Designer:** Carl Du Rietz, Jakobsgatan 6, 2nd floor, 11480 STOCKHOLM, Sverige (SE)
Dag Forsberg, Jakobsgatan 6, 2nd floor, 11480 STOCKHOLM, Sverige (SE)
Linus Östberg, Jakobsgatan 6, 2nd floor, 11480 STOCKHOLM, Sverige (SE)
Ka Man Chan, Jakobsgatan 6, 2nd floor, 11480 STOCKHOLM, Sverige (SE)

(55) **Designavbildninger:**



3.1

Design 4

- (54) **Produkt:** Ornamentation
(51) **Klasse:** 32-00
(72) **Designer:** Carl Du Rietz, Jakobsgatan 6, 2nd floor, 11480 STOCKHOLM, Sverige (SE)
Dag Forsberg, Jakobsgatan 6, 2nd floor, 11480 STOCKHOLM, Sverige (SE)
Linus Östberg, Jakobsgatan 6, 2nd floor, 11480 STOCKHOLM, Sverige (SE)
Ka Man Chan, Jakobsgatan 6, 2nd floor, 11480 STOCKHOLM, Sverige (SE)

(55) **Designavbildninger:**



4.1

Design 5

- (54) **Produkt:** Ornamentation
(51) **Klasse:** 32-00
(72) **Designer:** Carl Du Rietz, Jakobsgatan 6, 2nd floor, 11480 STOCKHOLM, Sverige (SE)
Dag Forsberg, Jakobsgatan 6, 2nd floor, 11480 STOCKHOLM, Sverige (SE)
Linus Östberg, Jakobsgatan 6, 2nd floor, 11480 STOCKHOLM, Sverige (SE)
Ka Man Chan, Jakobsgatan 6, 2nd floor, 11480 STOCKHOLM, Sverige (SE)

(55) **Designavbildninger:**



5.1

(11)	Reg.nr.:	DM/215929
(21)	Søkn.nr.:	20210877
(22)	Inngitt i WIPO:	2021.06.14
(15)	Registrert i WIPO:	2021.06.14
(24)	Løpedag:	2021.06.14
(43)	Allm. tilgj.:	2021.08.27
(15)	Besluttet gjeldende NO:	2021.09.02
(45)	Kunngjort NO:	2021.09.20
(18)	Reg. gjelder til:	2026.06.14
(73)	Innehaver:	Autocom Diagnostic Partner AB, Grafitvägen 23 B, 46138 TROLLHÄTTAN, Sverige

Design 1

(54)	Produkt:	Diagnostic testing apparatus other than for medical or laboratory purposes
(51)	Klasse:	10-05
(72)	Designer:	Martin Sallander, Östra Hamngatan 52, 41109 GÖTEBORG, Sverige (SE)
(30)	Prioritet:	2020.12.29, EM, 008373328, 1
(55)	Designavbildninger:	



1.1



1.2



1.3



1.4



1.5



1.6



1.7

(11)	Reg.nr.:	DM/215943
(21)	Søkn.nr.:	20210878
(22)	Inngitt i WIPO:	2021.03.30
(15)	Registrert i WIPO:	2021.03.30
(24)	Løpedag:	2021.03.30
(43)	Allm. tilgj.:	2021.08.27
(15)	Besluttet gjeldende NO:	2021.09.02
(45)	Kunngjort NO:	2021.09.20
(18)	Reg. gjelder til:	2026.03.30
(73)	Innehaver:	Hansgrohe SE, Auestrasse 5-9, 77761 SCHILTACH, Tyskland
(50)	Anmerkninger:	Registreringen gjelder samregistrering

Design 1

(54)	Produkt:	Bath towel rail
(51)	Klasse:	23-08
(72)	Designer:	Matthias Oesterle, Karlstr. 15, 73650 WINTERBACH, Tyskland (DE) Marco Flaig, Hauptmannsreute 96, 70193 STUTTGART, Tyskland (DE)
(30)	Prioritet:	2020.10.14, EM, 008203012, 1, 2, 3, 4, 5, 6, 7
(55)	Designavbildninger:	

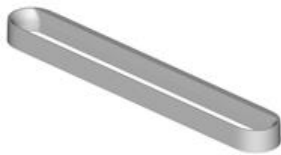

1.1



1.2



1.3



1.4



1.5



1.6



1.7

Design 2

- (54) **Produkt:** Hand shower holder
(51) **Klasse:** 23-08
(72) **Designer:** Matthias Oesterle, Karlstr. 15, 73650 WINTERBACH, Tyskland (DE)
Marco Flaig, Hauptmannsreute 96, 70193 STUTTGART, Tyskland (DE)
(30) **Prioritet:** 2020.10.14, EM, 008203012, 1, 2, 3, 4, 5, 6, 7
(55) **Designavbildninger:**



2.1



2.2



2.3



2.4



2.5



2.6



2.7

Design 3

- (54) **Produkt:** Bathroom brush holder
(51) **Klasse:** 23-08
(72) **Designer:** Matthias Oesterle, Karlstr. 15, 73650 WINTERBACH, Tyskland (DE)
Marco Flaig, Hauptmannsreute 96, 70193 STUTTGART, Tyskland (DE)
(30) **Prioritet:** 2020.10.14, EM, 008203012, 1, 2, 3, 4, 5, 6, 7
(55) **Designavbildninger:**

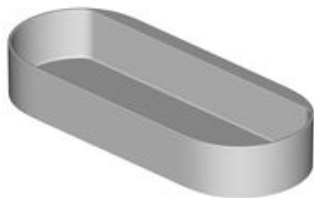

3.1

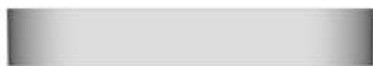

3.2

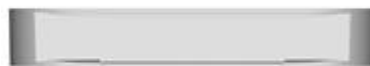

3.3



3.4



3.5

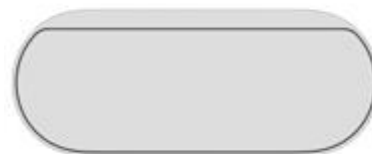

3.6



3.7

Design 4

- (54) **Produkt:** Bathroom brush holder
(51) **Klasse:** 23-08
(72) **Designer:** Matthias Oesterle, Karlstr. 15, 73650 WINTERBACH, Tyskland (DE)
Marco Flaig, Hauptmannsreute 96, 70193 STUTTGART, Tyskland (DE)
(30) **Prioritet:** 2020.10.14, EM, 008203012, 1, 2, 3, 4, 5, 6, 7
(55) **Designavbildninger:**

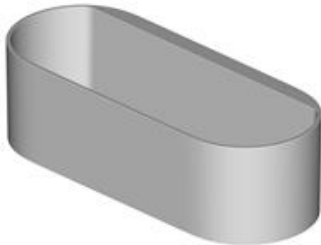

4.1



4.2

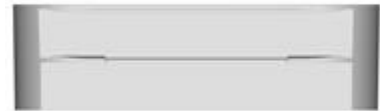

4.3



4.4



4.5



4.6

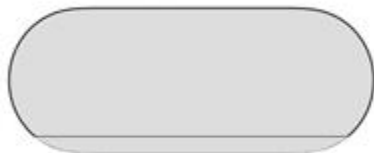

4.7

Design 5

- (54) **Produkt:** Bathroom brush holder
(51) **Klasse:** 23-08
(72) **Designer:** Matthias Oesterle, Karlstr. 15, 73650 WINTERBACH, Tyskland (DE)
Marco Flaig, Hauptmannsreute 96, 70193 STUTTGART, Tyskland (DE)
(30) **Prioritet:** 2020.10.14, EM, 008203012, 1, 2, 3, 4, 5, 6, 7
(55) **Designavbildninger:**



5.1



5.2



5.3



5.4



5.5

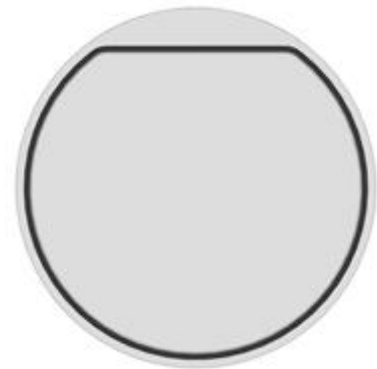

5.6

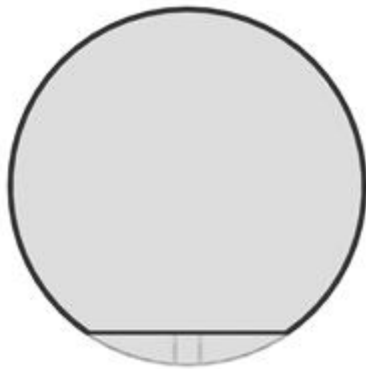

5.7

Design 6

- (54) **Produkt:** Toilet paper holder
(51) **Klasse:** 23-08
(72) **Designer:** Matthias Oesterle, Karlstr. 15, 73650 WINTERBACH, Tyskland (DE)
Marco Flaig, Hauptmannsreute 96, 70193 STUTTGART, Tyskland (DE)
(30) **Prioritet:** 2020.10.14, EM, 008203012, 1, 2, 3, 4, 5, 6, 7
(55) **Designavbildninger:**



6.1



6.2



6.3



6.4



6.5

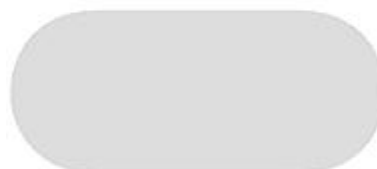

6.6



6.7

Design 7

- (54) **Produkt:** Toilet brush with holder
(51) **Klasse:** 23-08
(72) **Designer:** Matthias Oesterle, Karlstr. 15, 73650 WINTERBACH, Tyskland (DE)
Marco Flaig, Hauptmannsreute 96, 70193 STUTTGART, Tyskland (DE)
(30) **Prioritet:** 2020.10.14, EM, 008203012, 1, 2, 3, 4, 5, 6, 7
(55) **Designavbildninger:**



7.1



7.2



7.3



7.4



7.5



7.6



7.7

Fornyelse av registreringer

(11) **Reg.nr.:** 080003
(18) **Reg. gjelder til:** 2026.08.14
(73) **Innehaver:**
Jorma J. Koskinen, Anna Bøes vei 10, 1388 BORGEN,
Norge

(11) **Reg.nr.:** 080018
(18) **Reg. gjelder til:** 2026.09.08
(73) **Innehaver:**
Thorn Europhane, 156 Boulevard Haussmann, 75008
PARIS, Frankrike
(74) **Fullmektig:**
ZACCO NORWAY AS, Postboks 488, 0213 OSLO,
Norge

(11) **Reg.nr.:** 080077
(18) **Reg. gjelder til:** 2026.10.10
(73) **Innehaver:**
Arper SpA, Via Lombardia, 16, 31050 MONASTIER DI
TREVISO, Italia
(74) **Fullmektig:**
OSLO PATENTKONTOR AS, Hoffsvæien 1A, 0275
OSLO, Norge

(11) **Reg.nr.:** 080082
(18) **Reg. gjelder til:** 2026.10.10
(73) **Innehaver:**
Arper SpA, Via Lombardia, 16, 31050 MONASTIER DI
TREVISO, Italia
(74) **Fullmektig:**
OSLO PATENTKONTOR AS, Hoffsvæien 1A, 0275
OSLO, Norge

(11) **Reg.nr.:** 080083
(18) **Reg. gjelder til:** 2026.10.10
(73) **Innehaver:**
Arper SpA, Via Lombardia, 16, 31050 MONASTIER DI
TREVISO, Italia
(74) **Fullmektig:**
OSLO PATENTKONTOR AS, Hoffsvæien 1A, 0275
OSLO, Norge

(11) **Reg.nr.:** 080094
(18) **Reg. gjelder til:** 2026.08.28
(73) **Innehaver:**
Koninklijke Philips Electronics NV, Groenewoudseweg
1, 5621BA EINDHOVEN, Nederland
(74) **Fullmektig:**
ZACCO NORWAY AS, Postboks 488, 0213 OSLO,
Norge

(11) **Reg.nr.:** 080097
(18) **Reg. gjelder til:** 2026.10.13
(73) **Innehaver:**
BabyBjörn AB, Box 913, 17009 SOLNA, Sverige
(74) **Fullmektig:**
CURO AS, Vestre Rosten 81, 7075 TILLER, Norge

(11) **Reg.nr.:** 080282
(18) **Reg. gjelder til:** 2026.09.22
(73) **Innehaver:**
Sildnes Stenprodukter, 6490 EIDE, Norge
(74) **Fullmektig:**
Trygve Eide, Storgata 21, 6509 KRISTIANSUND N,
Norge

(11) **Reg.nr.:** 080343
(18) **Reg. gjelder til:** 2026.09.08
(73) **Innehaver:**
Lilleborg AS, Postboks 673 Skøyen, 0214 OSLO,
Norge
(74) **Fullmektig:**
PROTECTOR IP AS, Pilestredet 33, 0166 OSLO,
Norge

(11) **Reg.nr.:** 080395
(18) **Reg. gjelder til:** 2026.12.11
(73) **Innehaver:**
Brødrene Sunde AS, Borgundfjordveien 137, 6017
ÅLESUND, Norge
(74) **Fullmektig:**
ACAPO AS, Postboks 1880 Nordnes, 5817 BERGEN,
Norge

(11) **Reg.nr.:** 080583
(18) **Reg. gjelder til:** 2026.09.15
(73) **Innehaver:**
Parfums Christian Dior, 33, avenue Hoche, 75008
PARIS, Frankrike
(74) **Fullmektig:**
OSLO PATENTKONTOR AS, Hoffsvæien 1A, 0275
OSLO, Norge

(11) **Reg.nr.:** 083114
(18) **Reg. gjelder til:** 2026.04.08
(73) **Innehaver:**
Landteknikk AS, Postboks 83, Økern, 0508 OSLO,
Norge

(11) **Reg.nr.:** 083282
(18) **Reg. gjelder til:** 2026.09.13
(73) **Innehaver:**
Skruf Snus AB, Kungsgatan 12-14, 7. etg., 11135
STOCKHOLM, Sverige
(74) **Fullmektig:**
OSLO PATENTKONTOR AS, Hoffsvæien 1A, 0275
OSLO, Norge

(11) **Reg.nr.:** 083302
(18) **Reg. gjelder til:** 2026.10.28
(73) **Innehaver:**
Lonevåg Beslagfabrikk AS, 5282 LONEVÅG, Norge
(74) **Fullmektig:**
ACAPO AS, Postboks 1880 Nordnes, 5817 BERGEN,
Norge

(11) **Reg.nr.:** 083307
(18) **Reg. gjelder til:** 2026.08.26
(73) **Innehaver:**
IRCA SpA Industria Resistenze Corazzate e Affini,
Viale Venezia 31, 31020 SAN VENDEMIANO, Italia
(74) **Fullmektig:**
ONSAGERS AS, Postboks 1813, Vika, 0123 OSLO,
Norge

(11) **Reg.nr.:** 083324
(18) **Reg. gjelder til:** 2026.11.28
(73) **Innehaver:**
Universal Presentkort AS, Lille Grensen 7, 0159
OSLO, Norge
(74) **Fullmektig:**
PROTECTOR IP AS, Pilestredet 33, 0166 OSLO,
Norge

(11) **Reg.nr.:** 083336
(18) **Reg. gjelder til:** 2026.09.19
(73) **Innehaver:**
Tropicana Products Inc, 1001 13th Avenue East,
FL34208 BRADENTON, USA
(74) **Fullmektig:**
ZACCO NORWAY AS, Postboks 488, 0213 OSLO,
Norge

(11) **Reg.nr.:** 085377
(18) **Reg. gjelder til:** 2026.10.03
(73) **Innehaver:**
LUZENSE AS, Industriveien 11, 1481 HAGAN, Norge
(74) **Fullmektig:**
ADVOKATFIRMAET RÆDER AS, Postboks 2944
Solli, 0230 OSLO, Norge

(11) **Reg.nr.:** 085424
(18) **Reg. gjelder til:** 2026.06.03
(73) **Innehaver:**
NORDPEIS AS, Gjellebekkstubben 9-11, 3420
LIERSKOGEN, Norge
(74) **Fullmektig:**
CODEX ADVOKAT OSLO AS, Postboks 8744
St.Olavs plass, 0028 OSLO, Norge

(11) **Reg.nr.:** DM/075559
(18) **Reg. gjelder til:** 2021.02.15
(73) **Innehaver:**
Checkpoint Systems International GmbH, Ersheimer
Strasse 69, 69434 HIRSCHHORN, Tyskland

(11) **Reg.nr.:** DM/075832
(18) **Reg. gjelder til:** 2021.04.14
(73) **Innehaver:**
Ålö AB, Brännland 300, 90137 UMEÅ, Sverige

(11) **Reg.nr.:** DM/076693
(18) **Reg. gjelder til:** 2021.08.30
(73) **Innehaver:**
Daimler AG, Mercedesstrasse 120, 70372
STUTTGART, Tyskland

(11) **Reg.nr.:** DM/076721
(18) **Reg. gjelder til:** 2021.09.09
(73) **Innehaver:**
Pi-Design AG, Kantonsstrasse 100, 6234 TRIENGEN,
Sveits

(11) **Reg.nr.:** DM/076746
(18) **Reg. gjelder til:** 2021.08.23
(73) **Innehaver:**
Cartier International AG, Hinterbergstrasse 22, 6312
STEINHAUSEN, Sveits

(11) **Reg.nr.:** DM/076787
(18) **Reg. gjelder til:** 2021.09.09
(73) **Innehaver:**
ROLEX SA, Rue Francois-Dussaud 3-5-7, 1211
GENÈVE 26, Sveits

(11) **Reg.nr.:** DM/076864
(18) **Reg. gjelder til:** 2021.09.28
(73) **Innehaver:**
Aloys Wobben, Argenstrasse 19, 26607 AURICH,
Tyskland

(11) **Reg.nr.:** DM/076886
(18) **Reg. gjelder til:** 2021.08.22
(73) **Innehaver:**
De Buyer Industries, 25 Faymont, 88340 LE VAL
D'AJOL, Frankrike

(11) **Reg.nr.:** DM/076895
(18) **Reg. gjelder til:** 2021.09.26
(73) **Innehaver:**
Brita GmbH, Heinrich-Hertz-Strasse 4, 65232
TAUNUSSTEIN, Tyskland

(11) **Reg.nr.:** DM/092079
(18) **Reg. gjelder til:** 2021.07.27
(73) **Innehaver:**
AIROSOLUTIONS NV, Industriepark 33, 2220 HEIST-
OP-DEN-BERG, Belgia

(11) **Reg.nr.:** DM/092535
(18) **Reg. gjelder til:** 2021.08.29
(73) **Innehaver:**
Ziehm Imaging GmbH, Lina-Ammon-Straße 10, 90471
NÜRNBERG, Tyskland

(11) **Reg.nr.:** DM/092594
(18) **Reg. gjelder til:** 2021.09.16
(73) **Innehaver:**
Pi-Design AG, Kantonsstrasse 100, 6234 TRIENGEN,
Sveits

(11) **Reg.nr.:** DM/093009
(18) **Reg. gjelder til:** 2021.10.14
(73) **Innehaver:**
Intersnack Group GmbH & Co. KG, Peter-Müller-Str. 3,
40468 DÜSSELDORF, Tyskland

(11) **Reg.nr.:** DM/093380
(18) **Reg. gjelder til:** 2021.08.22
(73) **Innehaver:**
FREDERICK JOHN EIFFERT, 3 Balmoral Drive, NG31
8SY GRANTHAM, Storbritannia

(11) **Reg.nr.:** DM/093642
(18) **Reg. gjelder til:** 2021.11.01
(73) **Innehaver:**
Etac AB, Kista Science Tower, 16451 KISTA, Sverige

(11) **Reg.nr.:** DM/093662
(18) **Reg. gjelder til:** 2021.08.25
(73) **Innehaver:**
ENGINE, INC., (Jangan-dong, Changdo building) 5th
Floor, 395-2, Cheonho-daero, Dongdaemun-gu, 02633
SEOUL, Sør-Korea
Yong Jun Sung, (Ahasan Eullim Apt., Gyomun-dong)
103-1102, 27, Ahasan-ro 487beon-gil, Guri-si, 11952
GYEONGGI-DO, Sør-Korea

(11) **Reg.nr.:** DM/093663
(18) **Reg. gjelder til:** 2021.08.25
(73) **Innehaver:**
ENGINE, INC., (Jangan-dong, Changdo building) 5th
Floor, 395-2, Cheonho-daero, Dongdaemun-gu, 02633
SEOUL, Sør-Korea
Yong Jun Sung, (Ahasan Eullim Apt., Gyomun-dong)
103-1102, 27, Ahasan-ro 487beon-gil, Guri-si, 11952
GYEONGGI-DO, Sør-Korea

(11) **Reg.nr.:** DM/093664
(18) **Reg. gjelder til:** 2021.08.25
(73) **Innehaver:**
ENGINE, INC., (Jangan-dong, Changdo building) 5th
Floor, 395-2, Cheonho-daero, Dongdaemun-gu, 02633
SEOUL, Sør-Korea
Yong Jun Sung, (Ahasan Eullim Apt., Gyomun-dong)
103-1102, 27, Ahasan-ro 487beon-gil, Guri-si, 11952
GYEONGGI-DO, Sør-Korea

(11) **Reg.nr.:** DM/093665
(18) **Reg. gjelder til:** 2021.08.12
(73) **Innehaver:**
ENGINE, INC., (Jangan-dong, Changdo building) 5th
Floor, 395-2, Cheonho-daero, Dongdaemun-gu, 02633
SEOUL, Sør-Korea
Yong Jun Sung, (Ahasan Eullim Apt., Gyomun-dong)
103-1102, 27, Ahasan-ro 487beon-gil, Guri-si, 11952
GYEONGGI-DO, Sør-Korea

(11) **Reg.nr.:** DM/093666
(18) **Reg. gjelder til:** 2021.08.12
(73) **Innehaver:**
ENGINE, INC., (Jangan-dong, Changdo building) 5th
Floor, 395-2, Cheonho-daero, Dongdaemun-gu, 02633
SEOUL, Sør-Korea
Yong Jun Sung, (Ahasan Eullim Apt., Gyomun-dong)
103-1102, 27, Ahasan-ro 487beon-gil, Guri-si, 11952
GYEONGGI-DO, Sør-Korea

(11) **Reg.nr.:** DM/093667
(18) **Reg. gjelder til:** 2021.08.12
(73) **Innehaver:**
ENGINE, INC., (Jangan-dong, Changdo building) 5th
Floor, 395-2, Cheonho-daero, Dongdaemun-gu, 02633
SEOUL, Sør-Korea
Yong Jun Sung, (Ahasan Eullim Apt., Gyomun-dong)
103-1102, 27, Ahasan-ro 487beon-gil, Guri-si, 11952
GYEONGGI-DO, Sør-Korea

Slettede, utgåtte og opphørte nasjonale designregistreringer

- (11) **Reg.nr.: 076524**
- (11) **Reg.nr.: 077092**
- (11) **Reg.nr.: 079902**
- (11) **Reg.nr.: 079912**
- (11) **Reg.nr.: 079926**
- (11) **Reg.nr.: 082914**
- (11) **Reg.nr.: 082919**
- (11) **Reg.nr.: 082962**
- (11) **Reg.nr.: 083122**
- (11) **Reg.nr.: 083184**
- (11) **Reg.nr.: 083243**
- (11) **Reg.nr.: 085122**
- (11) **Reg.nr.: 085203**
- (11) **Reg.nr.: 085252**
- (11) **Reg.nr.: 085319**
- (11) **Reg.nr.: 085335**
- (11) **Reg.nr.: 085336**

Slettede, utgåtte og opphørte internasjonale designregistreringer

- (11) **Reg.nr.:** DM/086512
(73) **Innehaver:**
TOVARYSTVO Z OBMEZHENOIU
VIDPOVIDALNISTIU "NATSIONALNA HORJLCHANA
KOMPANIIA", Smilianske shose, 8-i kilometr, bud. 2,
s., 19632 STEPANKY, CHERKASKYI RAION,
CHERKASKA OBLAST, Ukraina
(75) **Adresse for korrespondanse:**
Polina Shchevich, Dniprovska Naberezhna, 23 V,
02081 KIEV, Ukraine (UA)
-

- (11) **Reg.nr.:** DM/089358
(73) **Innehaver:**
MARSAFE AB, Roslins väg 14b, 21755 MALMÖ,
Sverige
(75) **Adresse for korrespondanse:**
IPR & Innovation Ingela Stenberg AB, Vildsvinsvägen
4B, 24652 LÖDDEKÖPINGE, Sweden (SE)
-

- (11) **Reg.nr.:** DM/092606
(73) **Innehaver:**
ABRAM CORPORATION, Miyakawa Bldg. 2-8-10,
Hirakawacho, Chiyoda-ku, 102-0093 TOKYO, Japan
(75) **Adresse for korrespondanse:**
Masahiro MATSUSHITA, c/o IPP International Patent
Firm Ichigo Nishi-Gotanda Bldg. 8F, 3-6-20 Nishi-
Gotanda, Shinagawa-ku, 141-0031 TOKYO, Japan
(JP)
-