

Norsk

# design tidende

[www.patentstyret.no](http://www.patentstyret.no)

Norsk designtidende er en publikasjon som inneholder kunngjøringer innenfor designområdet

**BESØKSADRESSE**

- ▶ Sandakerveien 64

**POSTADRESSE**

- ▶ Postboks 4863 Nydalen  
0422 Oslo

**E-POST**

- ▶ [post@patentstyret.no](mailto:post@patentstyret.no)

**TELEFON**

- ▶ +47 22 38 73 00  
8.00-15.45

## Innholdsfortegnelse:

|   |     |
|---|-----|
| Registrerte design .....  | 3   |
| Internasjonale designregistreringer .....                               | 30  |
| Fornyelse av registreringer .....                                       | 121 |
| Overdragelser .....   | 123 |
| Endringer i fullmaktsforhold .....                                      | 124 |
| Slettede, utgåtte og opphørte nasjonale designregistreringer .....      | 125 |
| Slettede, utgåtte og opphørte internasjonale designregistreringer ..... | 126 |
| Innkomet krav om administrativ overprøving .....                        | 127 |
| Rettelse .....  | 128 |

### INID-koder

I kunngjøringene er de enkelte data forsynt med koder overensstemmende med INID-kodesystemet

(INID= Internationally agreed Numbers for the Identification of Data).

- (11) Registreringsnummer
- (15) Registreringsdato
- (18) Dato som registreringen gjelder til
- (21) Søknadsnummer
- (22) Inngivelsesdato
- (24) Løpedag
- (30) Prioritetsopplysninger
- (43) Allment tilgjengelig dato
- (51) Klasse
- (54) Produkt
- (55) Avbildning(er)
- (72) Designer
- (73) Innehaver
- (74) Fullmektig

## Registrerte design

*I henhold til designloven § 18 første ledd i.f. kunngjøres i dag følgende registrerte design.*

Det kan fremsettes krav om at designregistreringen helt eller delvis skal oppheves, jf. designloven §§ 25 flg. og designforskriften §§ 26 flg.

Designregistreringen gjelder for den eller de periodene på fem år som søknaden er innlevert for, regnet fra søknadsdagen. Registreringen kan fornyes, jf. designloven §§ 23 og 24. Maksimal beskyttelsestid er 25 år. For reservedeler, se unntaket i designloven § 23 annet ledd.

|      |                          |   |
|------|--------------------------|---|
| (11) | <b>Reg.nr.:</b>          | <b>086378</b>   |
| (21) | <b>Søkn.nr.:</b>         | 20190846  |
| (22) | <b>Inngitt:</b>          | 2019.07.04  |
| (24) | <b>Løpedag:</b>          | 2019.07.04  |
| (43) | <b>Allm. tilgj.:</b>     | 2019.08.12  |
| (15) | <b>Registrert:</b>       | 2019.08.12  |
| (45) | <b>Kunngjort:</b>        | 2019.09.09  |
| (18) | <b>Reg. gjelder til:</b> | 2024.07.04  |
| (73) | <b>Innehaver:</b>        | SUHONEN TIINA TUULIA K, RØHRTS VEI 35 B, 1181 OSLO, Norge |

### Design 1

|      |                            |  |
|------|----------------------------|--|
| (54) | <b>Produkt:</b>            | Logo   |
| (51) | <b>Klasse:</b>             | 32-00  |
| (72) | <b>Designer:</b>           | SUHONEN TIINA TUULIA K, RØHRTS VEI 35 B, 1181 OSLO<br>Reilika Landen, Lepistökuja 1, 15270 KUKKILA, Finland (FI) |
| (55) | <b>Designavbildninger:</b> |  |



1.1

- (11) **Reg.nr.:** 086379  
(21) **Søkn.nr.:** 20190500  
(22) **Inngitt:** 2019.06.17  
(24) **Løpedag:** 2019.06.17  
(43) **Allm. tilgj.:** 2019.07.07  
(15) **Registrert:** 2019.08.12  
(45) **Kunngjort:** 2019.09.09  
(18) **Reg. gjelder til:** 2024.06.17  
(73) **Innehaver:** Pa-So Produkter i Avesta Aktiebolag, Krongjutaregatan 17, 77435 AVESTA, Sverige  
(74) **Fullmektig:** CURO AS, Vestre Rosten 81, 7075 TILLER, Norge  
(50) **Anmerkninger:** Registreringen gjelder samregistrering.

**Design 1**

- (54) **Produkt:** Festeanordning  
(51) **Klasse:** 08-08  
(72) **Designer:** Patrik Björk, Diktargränd 6, 77571 KRYLBO, Sverige (SE)  
Sophie Södergren, Germundsbo 37, 77492 AVESTA, Sverige (SE)  
(30) **Prioritet:** 2019.01.07, EM, 005949690, 1, 2  
(55) **Designavbildninger:**

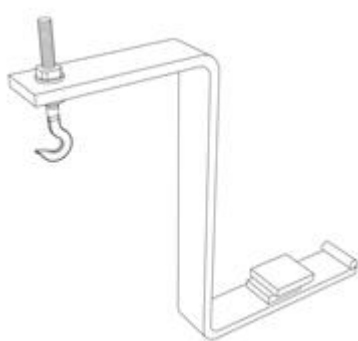

1.1



1.2



1.3

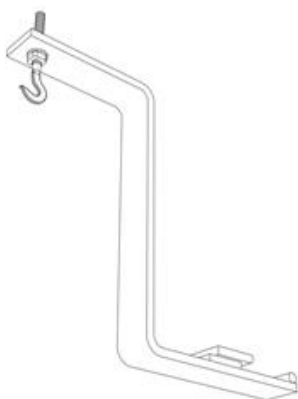

1.4



1.5



1.6

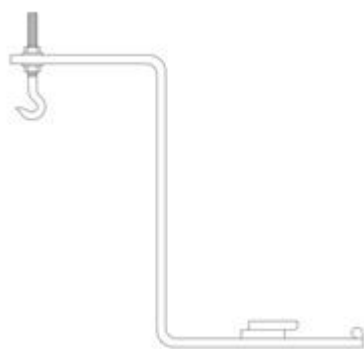

1.7

**Design 2**

- (54) **Produkt:** Festeanordning  
(51) **Klasse:** 08-08  
(72) **Designer:** Patrik Björk, Diktargränd 6, 77571 KRYLBO, Sverige (SE)  
Sophie Södergren, Germundsbo 37, 77492 AVESTA, Sverige (SE)  
(30) **Prioritet:** 2019.01.07, EM, 005949690, 1, 2  
(55) **Designavbildninger:**

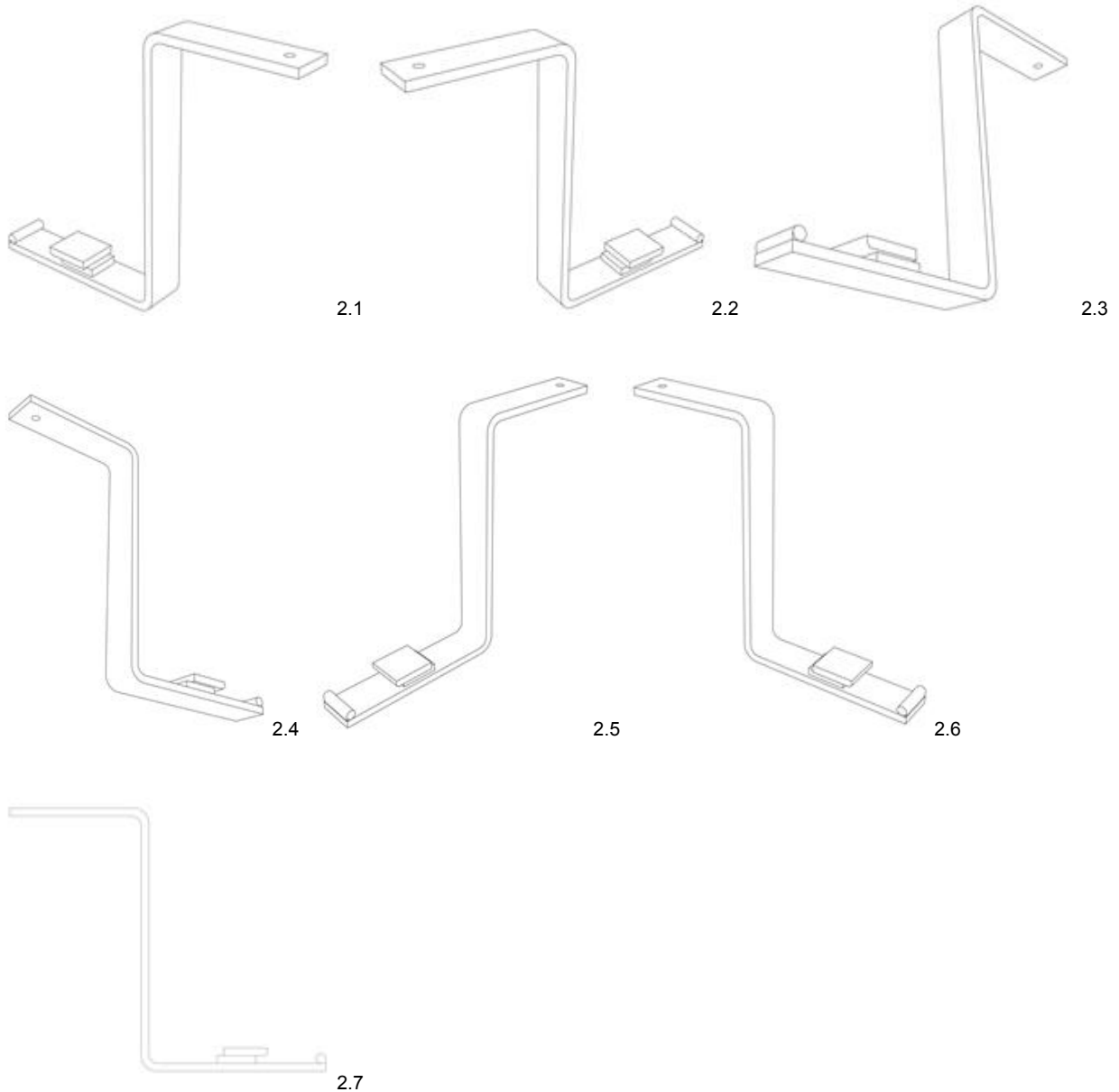

- (11) **Reg.nr.:** 086380  
(21) **Søkn.nr.:** 20190301  
(22) **Inngitt:** 2019.04.25  
(24) **Løpedag:** 2019.04.25  
(43) **Allm. tilgj.:** 2019.04.25  
(15) **Registrert:** 2019.08.12  
(45) **Kunngjort:** 2019.09.09  
(18) **Reg. gjelder til:** 2024.04.25  
(73) **Innehaver:** Episurf IP-Management AB, Karlvägen 60, 11449 STOCKHOLM, Sverige  
(74) **Fullmektig:** IPQ IP Specialists AB, Docketing Box 42, 68323 HAGFORS, Sverige

**Design 1**

- (54) **Produkt:** Skjerm bilde  
(51) **Klasse:** 14-04  
(72) **Designer:** Jeanette SPÅNGBERG, Komedivägen 7, 14243 SKOGÅS, Sverige (SE)  
(50) **Anmerkning:** Designet er i farger.  
(55) **Designavbildninger:**

**EPIOSCOPY ORDER - EPF25**

PRODUCT: Epioscopy

CASE-SPECIFIC FILES: UPB54\_CartilageThickness.pdf

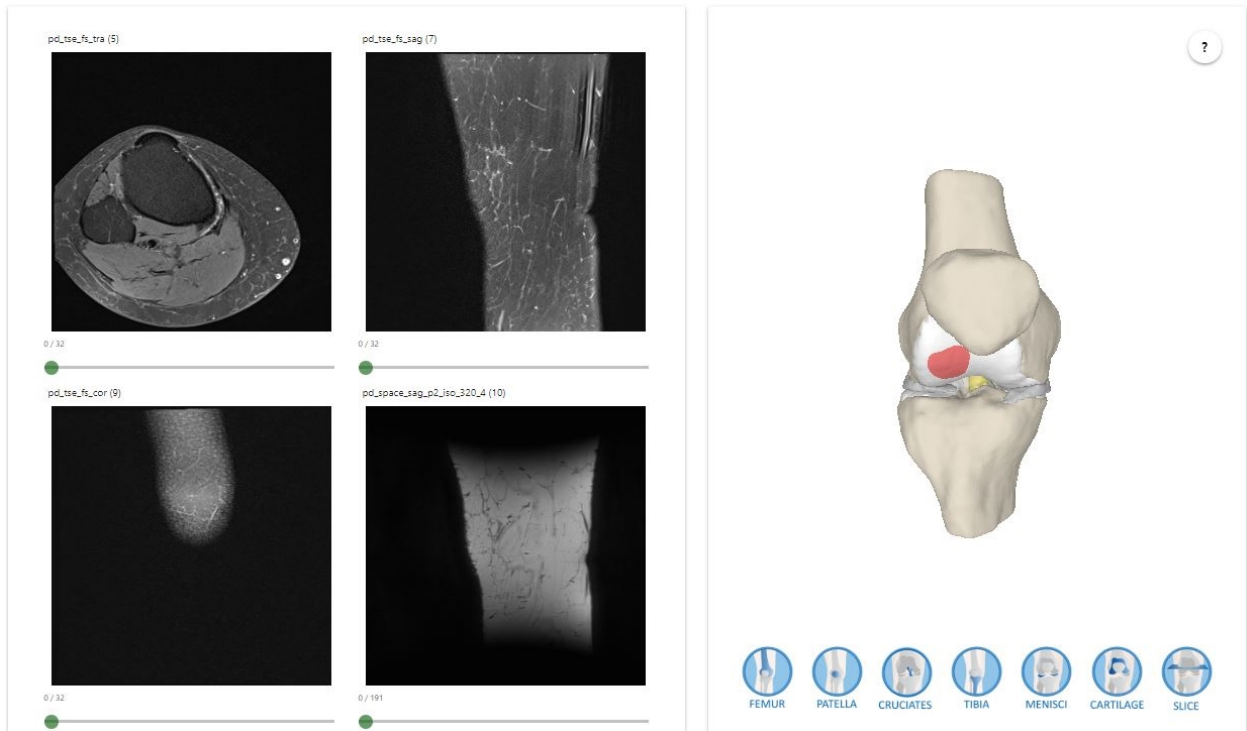

1.1

- (11) **Reg.nr.:** 086381  
(21) **Søkn.nr.:** 20190497  
(22) **Inngitt:** 2019.06.16  
(24) **Løpedag:** 2019.06.16  
(43) **Allm. tilgj.:** 2019.06.16  
(15) **Registrert:** 2019.08.12  
(45) **Kunngjort:** 2019.09.09  
(18) **Reg. gjelder til:** 2024.06.16  
(73) **Innehaver:** Artur Stanislaw Wozniak, Bergsliens gate 6, 0354 OSLO, Norge

**Design 1**

- (54) **Produkt:** Del av fiolin  
(51) **Klasse:** 17-03  
(72) **Designer:** Artur Stanislaw Wozniak, Bergsliens gate 6, 0354 OSLO  
(55) **Designavbildninger:**

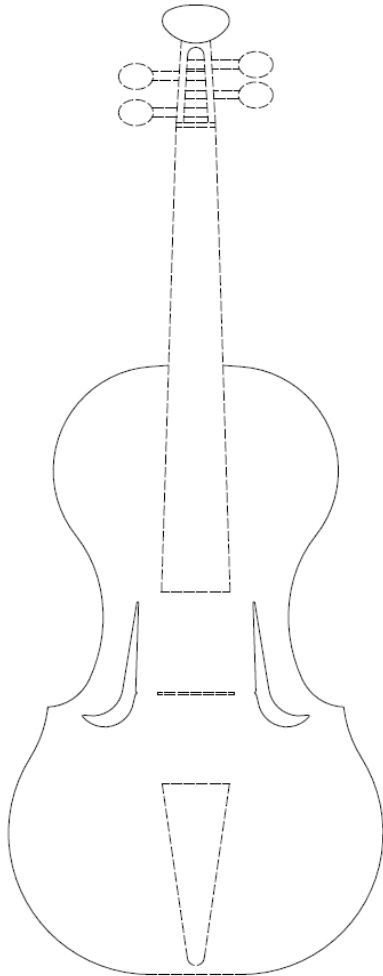

1.1

- (11) **Reg.nr.:** 086382  
(21) **Søkn.nr.:** 20190496  
(22) **Inngitt:** 2019.06.17  
(24) **Løpedag:** 2019.06.17  
(43) **Allm. tilgj.:** 2019.08.12  
(15) **Registrert:** 2019.08.12  
(45) **Kunngjort:** 2019.09.09  
(18) **Reg. gjelder til:** 2024.06.17  
(73) **Innehaver:** USER SOLUTIONS AS, c/o Vegard Ertvaag Lurevegen 148, 5912 SEIM, Norge

**Design 1**

- (54) **Produkt:** Kokeinnretning  
(51) **Klasse:** 07-02  
(72) **Designer:** Thor Øyvind Rafto, Søråshøgda 43, 5235 RÅDAL  
ERTVAAG VEGARD JOHN, LUREVEGEN 148, 5912 SEIM  
(55) **Designavbildninger:**



1.1



1.2



1.3



1.4

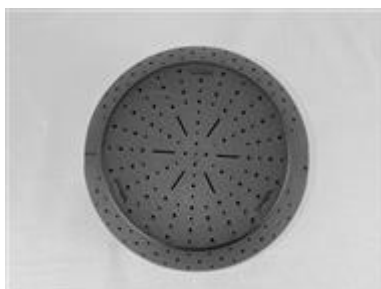

1.5



1.6



1.7



- (11) **Reg.nr.:** 086383  
(21) **Søkn.nr.:** 20190872  
(22) **Inngitt:** 2019.07.09  
(24) **Løpedag:** 2019.07.09  
(43) **Allm. tilgj.:** 2019.08.12  
(15) **Registrert:** 2019.08.12  
(45) **Kunngjort:** 2019.09.09  
(18) **Reg. gjelder til:** 2024.07.09  
(73) **Innehaver:** TOM ENDRE TOLLEFSEN, HVITTINGFOSSVEIEN 292, 3089 HOLMESTRAND, Norge

**Design 1**

- (54) **Produkt:** Rørholder  
(51) **Klasse:** 08-08  
(72) **Designer:** PTFE PIPE SYSTEMS Tom Tollefsen, Hvittingfossveien 292, 3089 HOLMESTRAND  
TOM ENDRE TOLLEFSEN, HVITTINGFOSSVEIEN 292, 3089 HOLMESTRAND  
(55) **Designavbildninger:**



1.1



1.2

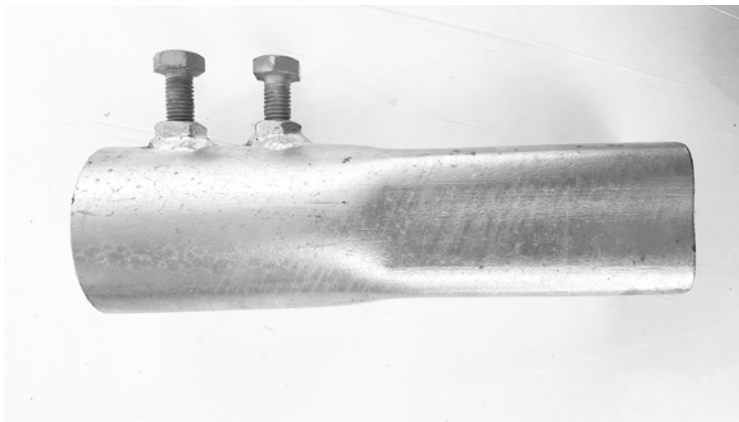

1.3

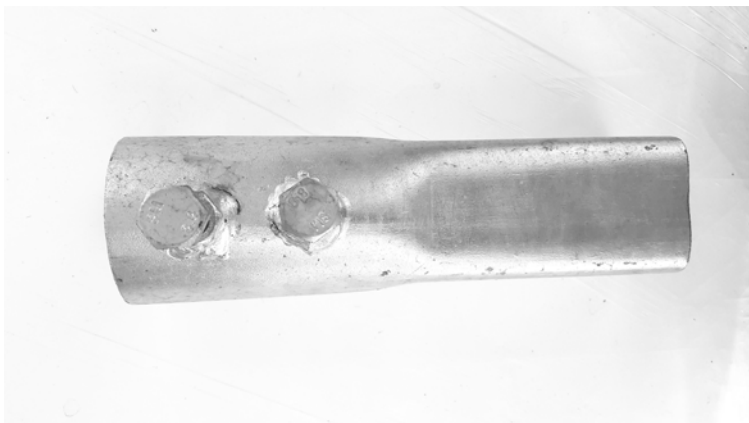

1.4

- (11) **Reg.nr.:** 086384  
(21) **Søkn.nr.:** 20190060  
(22) **Inngitt:** 2019.02.04  
(24) **Løpedag:** 2019.02.04  
(43) **Allm. tilgj.:** 2019.08.04  
(15) **Registrert:** 2019.08.14  
(45) **Kunngjort:** 2019.09.09  
(18) **Reg. gjelder til:** 2024.02.04  
(73) **Innehaver:** VESTRE AS, Drammensveien 44A, 0271 OSLO, Norge  
(74) **Fullmektig:** ZACCO NORWAY AS, Postboks 2003 Vika, 0125 OSLO, Norge

**Design 1**

- (54) **Produkt:** Benk  
(51) **Klasse:** 06-01  
(72) **Designer:** Allan Hagerup, Schweigaardsgt. 91B, 0656 OSLO  
(55) **Designavbildninger:**

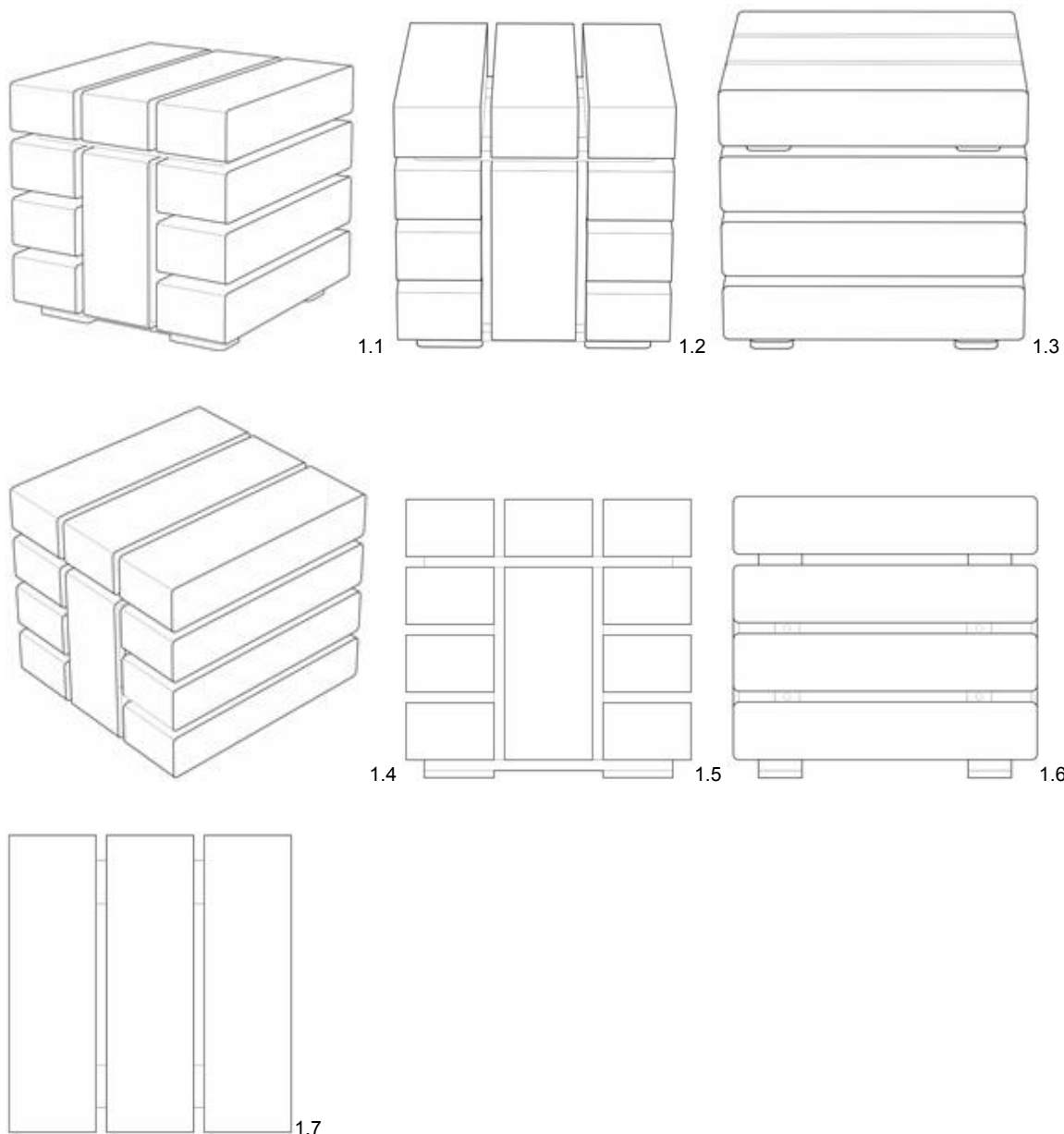

- (11) **Reg.nr.:** 086385  
(21) **Søkn.nr.:** 20190061  
(22) **Inngitt:** 2019.02.04  
(24) **Løpedag:** 2019.02.04  
(43) **Allm. tilgj.:** 2019.08.04  
(15) **Registrert:** 2019.08.14  
(45) **Kunngjort:** 2019.09.09  
(18) **Reg. gjelder til:** 2024.02.04  
(73) **Innehaver:** VESTRE AS, Drammensveien 44A, 0271 OSLO, Norge  
(74) **Fullmektig:** ZACCO NORWAY AS, Postboks 2003 Vika, 0125 OSLO, Norge

**Design 1**

- (54) **Produkt:** Benk  
(51) **Klasse:** 06-01  
(72) **Designer:** Espen Voll, Nordre gate 2, 0551 OSLO  
Torbjørn Andersen, Oscars gate 92, 0256 OSLO  
(55) **Designavbildninger:**

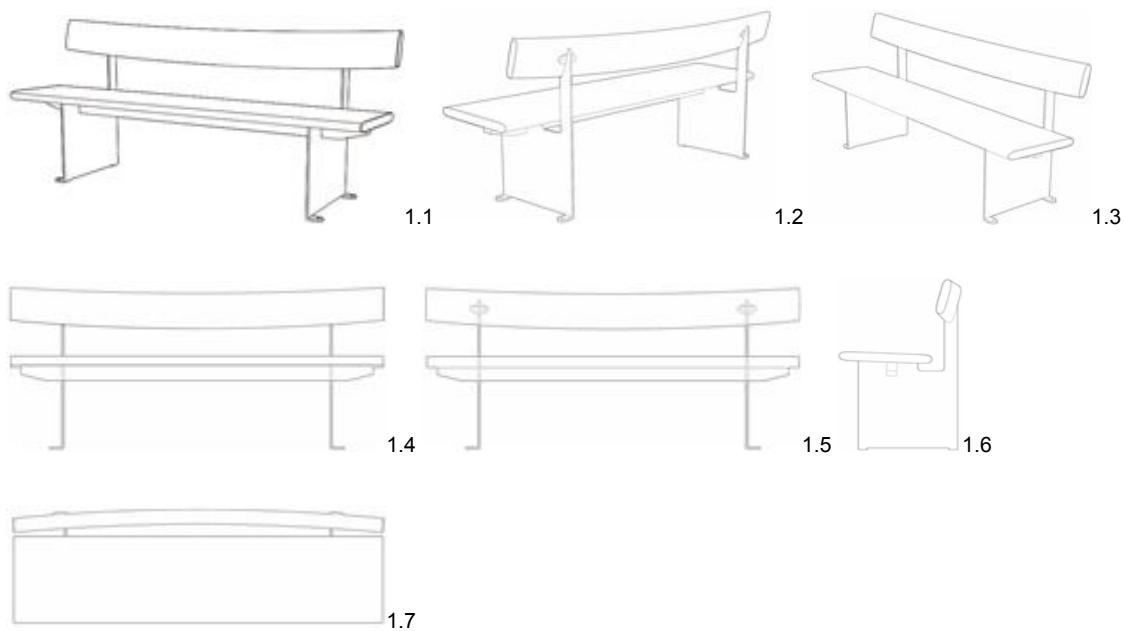

- (11) **Reg.nr.:** 086386  
(21) **Søkn.nr.:** 20190062  
(22) **Inngitt:** 2019.02.04  
(24) **Løpedag:** 2019.02.04  
(43) **Allm. tilgj.:** 2019.08.04  
(15) **Registrert:** 2019.08.14  
(45) **Kunngjort:** 2019.09.09  
(18) **Reg. gjelder til:** 2024.02.04  
(73) **Innehaver:** VESTRE AS, Drammensveien 44A, 0271 OSLO, Norge  
(74) **Fullmektig:** ZACCO NORWAY AS, Postboks 2003 Vika, 0125 OSLO, Norge  
(50) **Anmerkninger:** Registreringen gjelder samregistrering.

**Design 1**

- (54) **Produkt:** Blomsterkasse for utendørs bruk  
(51) **Klasse:** 25-02  
(72) **Designer:** Lars Tornøe, Kvitsøygata 10, 4014 STAVANGER  
(55) **Designavbildninger:**

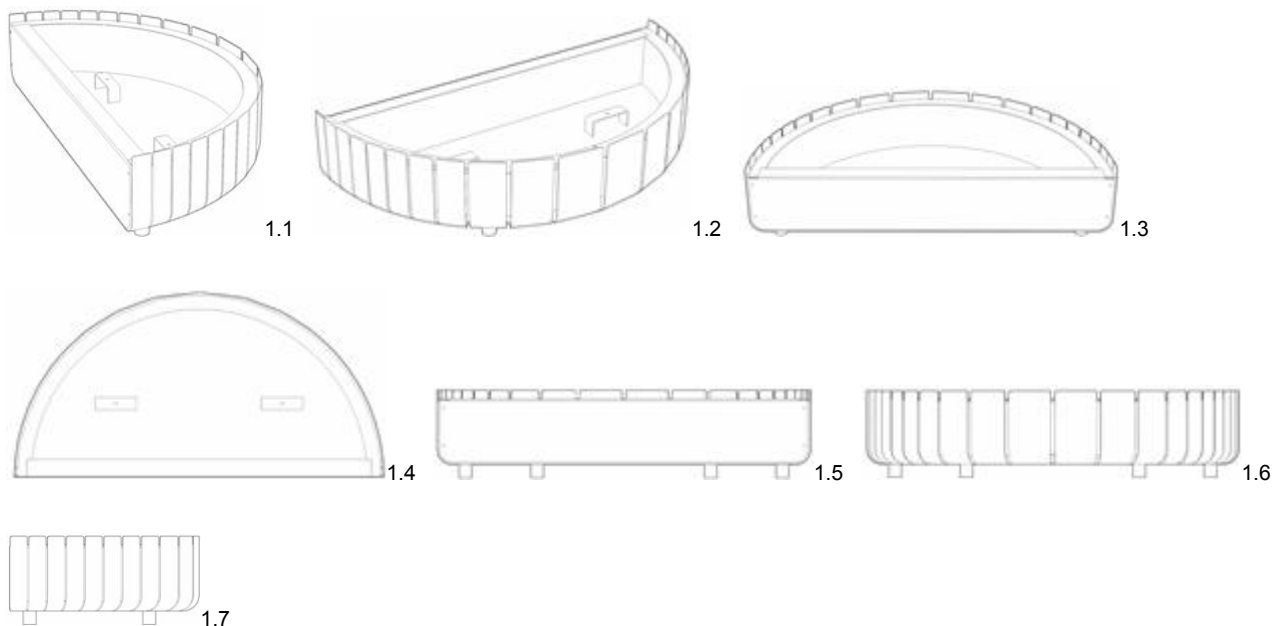
**Design 2**

- (54) **Produkt:** Blomsterkasse for utendørs bruk  
(51) **Klasse:** 25-02  
(72) **Designer:** Lars Tornøe, Kvitsøygata 10, 4014 STAVANGER  
(55) **Designavbildninger:**

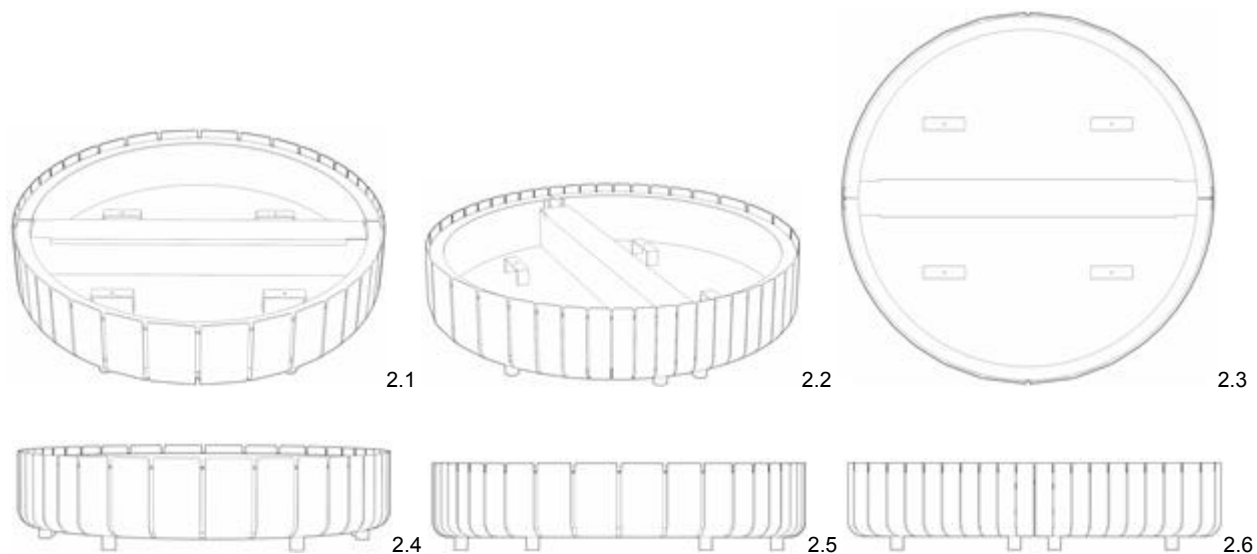

**Design 3**

- (54) **Produkt:** Blomsterkasse for utendørs bruk  
(51) **Klasse:** 25-02  
(72) **Designer:** Lars Tornøe, Kvitsøygata 10, 4014 STAVANGER  
(55) **Designavbildninger:**



3.1

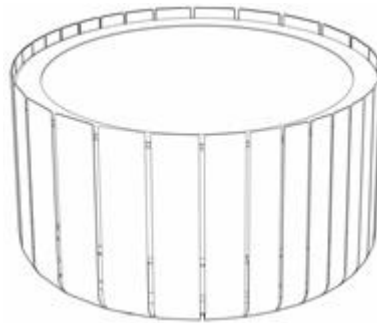

3.2

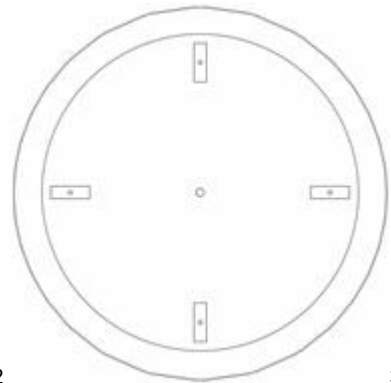

3.3

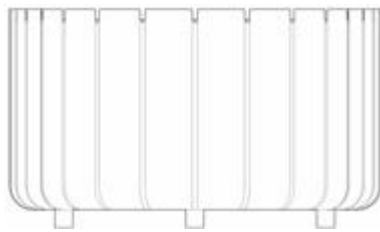

3.4

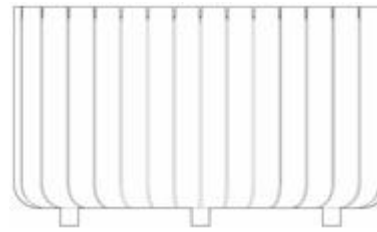

3.5

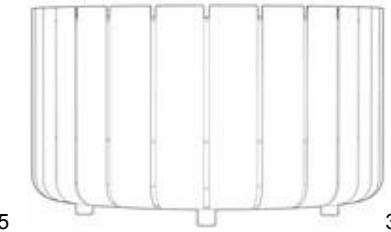

3.6

**Design 4**

- (54) **Produkt:** Blomsterkasse for utendørs bruk  
(51) **Klasse:** 25-02  
(72) **Designer:** Lars Tornøe, Kvitsøygata 10, 4014 STAVANGER  
(55) **Designavbildninger:**

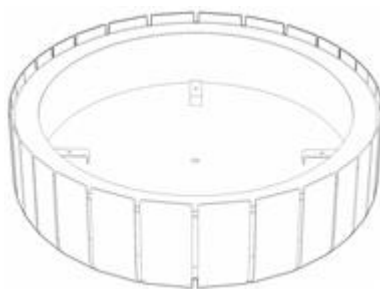

4.1

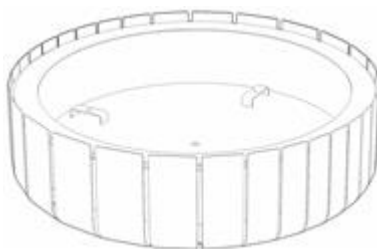

4.2



4.3



4.4

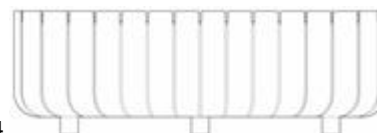

4.5

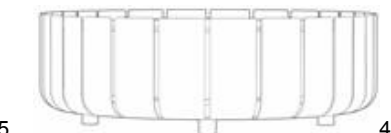

4.6

- (11) **Reg.nr.:** 086387  
(21) **Søkn.nr.:** 20190347  
(22) **Inngitt:** 2019.05.13  
(24) **Løpedag:** 2019.05.13  
(43) **Allm. tilgj.:** 2019.05.13  
(15) **Registrert:** 2019.08.15  
(45) **Kunngjort:** 2019.09.09  
(18) **Reg. gjelder til:** 2024.05.13  
(73) **Innehaver:** KRISTNE KONGREGASJON I NORGE, c/o Leander Zeiner, Fuglebakk 3, 3482 TOFTE, Norge

**Design 1**

- (54) **Produkt:** Skilt  
(51) **Klasse:** 20-03  
(72) **Designer:** ZEINER CONSULTING, Fuglebakk 3, 3482 TOFTE  
(55) **Designavbildninger:**



1.1

- (11) **Reg.nr.:** 086388  
(21) **Søkn.nr.:** 20190341  
(22) **Inngitt:** 2019.05.08  
(24) **Løpedag:** 2019.05.08  
(43) **Allm. tilgj.:** 2019.08.16  
(15) **Registrert:** 2019.08.16  
(45) **Kunngjort:** 2019.09.09  
(18) **Reg. gjelder til:** 2024.05.08  
(73) **Innehaver:** NORTHERN NO AS, Bygdøy allé 68, 0265 OSLO, Norge

**Design 1**

- (54) **Produkt:** Bordlampe  
(51) **Klasse:** 26-05  
(72) **Designer:** Antoine Rouzeau, 8 rue Monmory, 94300 VINCENNES, Frankrike (FR)  
(55) **Designavbildninger:**



1.1



1.2

- (11) **Reg.nr.:** 086389  
(21) **Søkn.nr.:** 20190071  
(22) **Inngitt:** 2019.02.07  
(24) **Løpedag:** 2019.02.07  
(43) **Allm. tilgj.:** 2019.08.07  
(15) **Registrert:** 2019.08.19  
(45) **Kunngjort:** 2019.09.09  
(18) **Reg. gjelder til:** 2024.02.07  
(73) **Innehaver:** BONDURA TECHNOLOGY AS, Postboks 98, 4349 BRYNE, Norge  
(74) **Fullmektig:** HÅMSØ PATENTBYRÅ AS, Postboks 171, 4301 SANDNES, Norge  
(50) **Anmerkninger:** Registreringen gjelder samregistrering.

**Design 1**

- (54) **Produkt:** Skruer med muttere  
(51) **Klasse:** 08-08  
(72) **Designer:** Øyvind Karlsen, Turveien 4, 4018 STAVANGER  
(55) **Designavbildninger:**

**Design 2**

- (54) **Produkt:** Skruer  
(51) **Klasse:** 08-08  
(72) **Designer:** Øyvind Karlsen, Turveien 4, 4018 STAVANGER  
(55) **Designavbildninger:**

**Design 3**

- (54) **Produkt:** Mutter  
(51) **Klasse:** 08-08  
(72) **Designer:** Øyvind Karlsen, Turveien 4, 4018 STAVANGER  
(55) **Designavbildninger:**

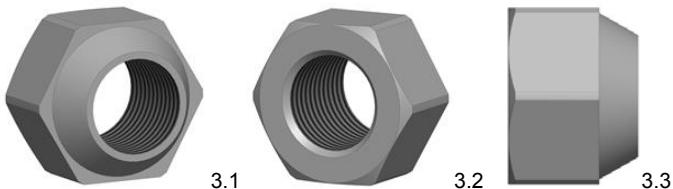



**Design 4**

- (54) **Produkt:** Låsemutter  
(51) **Klasse:** 08-08  
(72) **Designer:** Øyvind Karlsen, Turveien 4, 4018 STAVANGER  
(55) **Designavbildninger:**

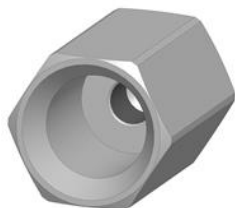

4.1



4.2



4.3

- (11) **Reg.nr.:** 086390  
(21) **Søkn.nr.:** 20190507  
(22) **Inngitt:** 2019.06.20  
(24) **Løpedag:** 2019.06.20  
(43) **Allm. tilgj.:** 2019.06.21  
(15) **Registrert:** 2019.08.20  
(45) **Kunngjort:** 2019.09.09  
(18) **Reg. gjelder til:** 2024.06.20  
(73) **Innehaver:** Schneider Electric Industries SAS, 35, rue Joseph Monier - CS30323, 92500 RUEIL-MALMAISON, Frankrike  
(74) **Fullmektig:** PROTECTOR IP AS, Pilestredet 33, 0166 OSLO, Norge  
(50) **Anmerkninger:** Registreringen gjelder samregistrering.

**Design 1**

- (54) **Produkt:** Stikkontakt  
(51) **Klasse:** 13-03  
(72) **Designer:** Guillaume Reiner, 9 chemin de la Vierge Noire, 38700 LA TRONCHE, Frankrike (FR)  
Yee Hsien Tan, 9 rue Barginet, 38000 GRENOBLE, Frankrike (FR)  
(30) **Prioritet:** 2018.12.21, EM, 005942182, 1,2,3  
(55) **Designavbildninger:**

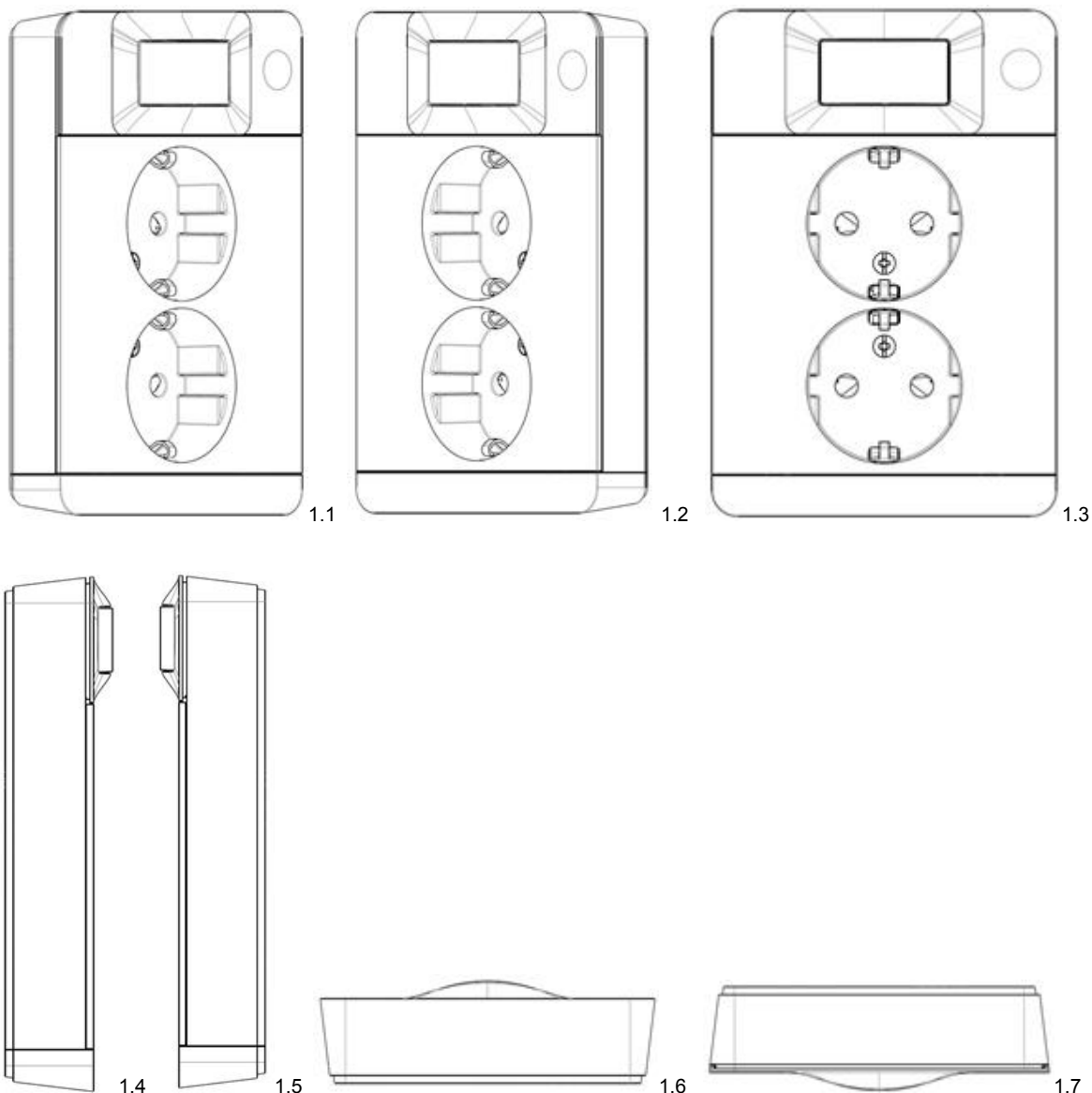

**Design 2**

- (54) **Produkt:** Stikkontakt  
(51) **Klasse:** 13-03  
(72) **Designer:** Guillaume Reiner, 9 chemin de la Vierge Noire, 38700 LA TRONCHE, Frankrike (FR)  
Yee Hsien Tan, 9 rue Barginet, 38000 GRENOBLE, Frankrike (FR)  
(30) **Prioritet:** 2018.12.21, EM, 005942182, 1,2,3  
(55) **Designavbildninger:**

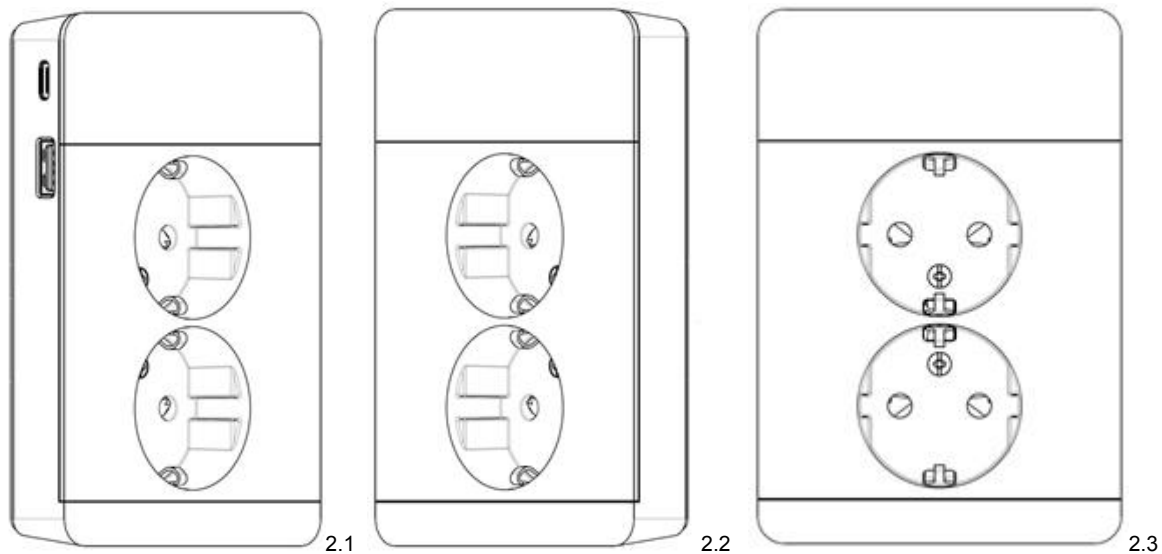

**Design 3**

- (54) **Produkt:** Stikkontakt  
(51) **Klasse:** 13-03  
(72) **Designer:** Guillaume Reiner, 9 chemin de la Vierge Noire, 38700 LA TRONCHE, Frankrike (FR)  
Yee Hsien Tan, 9 rue Barginet, 38000 GRENOBLE, Frankrike (FR)  
(30) **Prioritet:** 2018.12.21, EM, 005942182, 1,2,3  
(55) **Designavbildninger:**

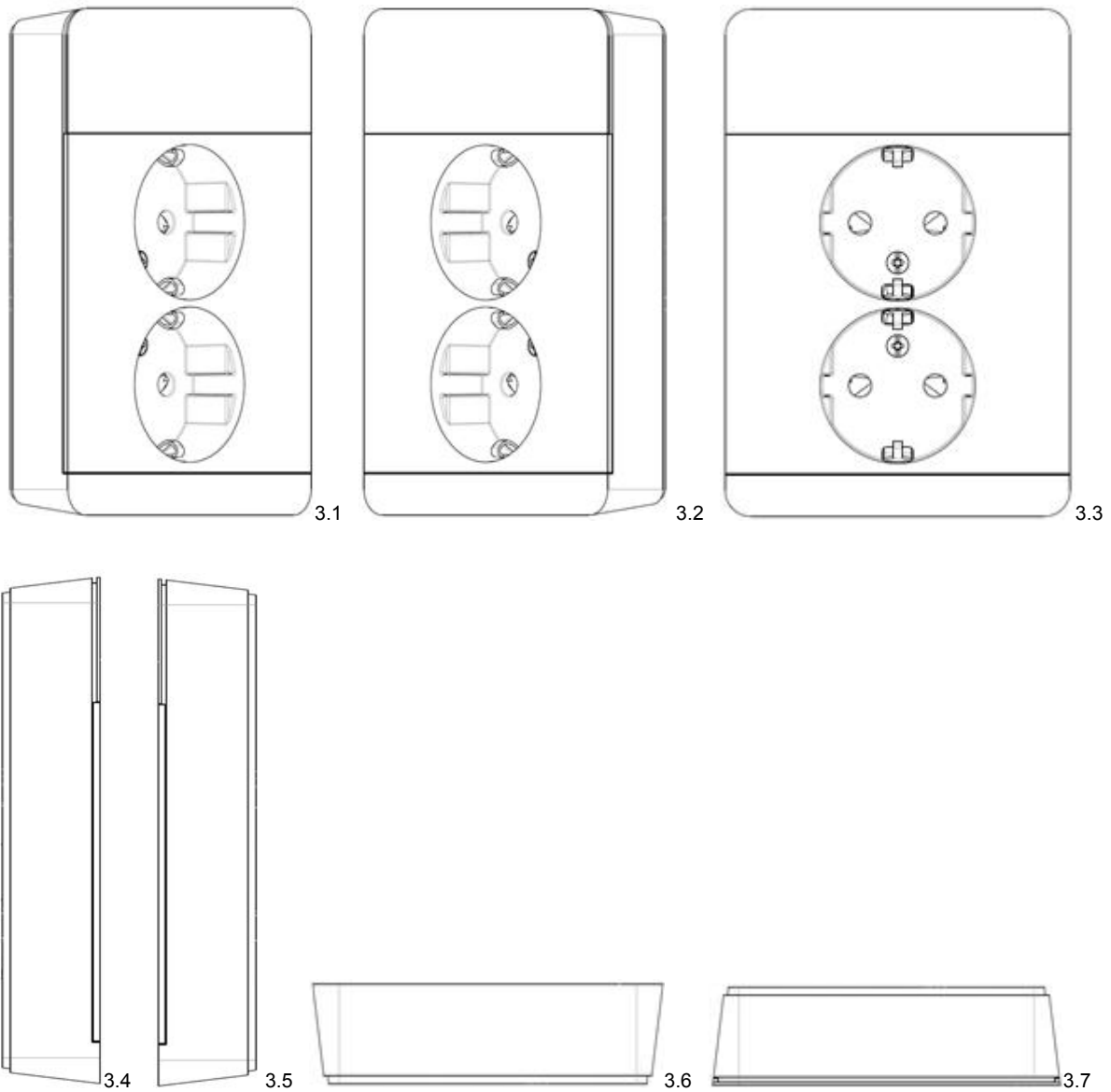

- (11) **Reg.nr.:** 086391  
(21) **Søkn.nr.:** 20190366  
(22) **Inngitt:** 2019.05.16  
(24) **Løpedag:** 2019.05.16  
(43) **Allm. tilgj.:** 2019.05.16  
(15) **Registrert:** 2019.08.20  
(45) **Kunngjort:** 2019.09.09  
(18) **Reg. gjelder til:** 2024.05.16  
(73) **Innehaver:** Eurostar Danmark A/S, Tigervej 12-14, 4600 KØGE, Danmark  
(74) **Fullmektig:** TANDBERG INNOVATION AS, Postboks 1570 Vika, 0118 OSLO, Norge  
(50) **Anmerkninger:** Registreringen gjelder samregistrering.

**Design 1**

- (54) **Produkt:** Overflatemønster for veibane  
(51) **Klasse:** 32-00  
(72) **Designer:** Eurostar Danmark A/S, Tigervej 12-14, 4600 KØGE, Danmark (DK)  
(30) **Prioritet:** 2019.05.07, EM, 006432076, 1, 2  
(55) **Designavbildninger:**



1.1

**Design 2**

- (54) **Produkt:** Overflatemønster for veibane  
(51) **Klasse:** 32-00  
(72) **Designer:** Eurostar Danmark A/S, Tigervej 12-14, 4600 KØGE, Danmark (DK)  
(30) **Prioritet:** 2019.05.07, EM, 006432076, 1, 2  
(55) **Designavbildninger:**



|      |                          |  |
|------|--------------------------|--|
| (11) | <b>Reg.nr.:</b>          | <b>086392</b>  |
| (21) | <b>Søkn.nr.:</b>         | 20190343   |
| (22) | <b>Inngitt:</b>          | 2019.05.09   |
| (24) | <b>Løpedag:</b>          | 2019.05.09   |
| (43) | <b>Allm. tilgj.:</b>     | 2019.08.21   |
| (15) | <b>Registrert:</b>       | 2019.08.21   |
| (45) | <b>Kunngjort:</b>        | 2019.09.09   |
| (18) | <b>Reg. gjelder til:</b> | 2024.05.09   |
| (73) | <b>Innehaver:</b>        | DERMATOLOG NO AS, Postboks 474 Bedriftssenteret, 1411 KOLBOTN, Norge |
| (74) | <b>Fullmektig:</b>       | NORSK PATENTBYRÅ AS, Postboks 1204 Vikå, 0110 OSLO, Norge            |

**Design 1**

|      |                            |  |
|------|----------------------------|--|
| (54) | <b>Produkt:</b>            | Linse til mobiltelefonkamera til bruk ved fotografering av føflekker |
| (51) | <b>Klasse:</b>             | 16-06  |
| (72) | <b>Designer:</b>           | DERMATOLOG NO AS, Postboks 474 Bedriftssenteret, 1411 KOLBOTN        |
| (55) | <b>Designavbildninger:</b> |  |



1.1



1.2

- (11) **Reg.nr.:** 086393  
(21) **Søkn.nr.:** 20190506  
(22) **Inngitt:** 2019.06.19  
(24) **Løpedag:** 2019.06.19  
(43) **Allm. tilgj.:** 2019.08.22  
(15) **Registrert:** 2019.08.22  
(45) **Kunngjort:** 2019.09.09  
(18) **Reg. gjelder til:** 2024.06.19  
(73) **Innehaver:** Bombardier Transportation GmbH, Eichhornstrasse 3, 10785 BERLIN, Tyskland  
(74) **Fullmektig:** ZACCO NORWAY AS, Postboks 2003 Vika, 0125 OSLO, Norge  
(50) **Anmerkninger:** Registreringen gjelder samregistrering.

**Design 1**

- (54) **Produkt:** Del av tog  
(51) **Klasse:** 12-03  
(72) **Designer:** David Gordon, 11 Mallard Way, DE248GX PRIDE PARK, DERBY, Storbritannia (GB)  
Gero Garske, Manteuffelstr. 66, 10999 BERLIN, Tyskland (DE)  
Nicole Michel, Schmiedegasse 33, 14469 POTSDAM, Tyskland (DE)  
Claudia Wessner, Czarnikauer Str. 6, 10439 BERLIN, Tyskland (DE)

**(55) Designavbildninger:**

1.1



1.2



1.3



1.4



1.5



1.6



1.7



**Design 2**

- (54) **Produkt:** Del av tog  
(51) **Klasse:** 12-03  
(72) **Designer:** David Gordon, 11 Mallard Way, DE248GX PRIDE PARK, DERBY, Storbritannia (GB)  
Gero Garske, Manteuffelstr. 66, 10999 BERLIN, Tyskland (DE)  
Nicole Michel, Schmiedegasse 33, 14469 POTSDAM, Tyskland (DE)  
Claudia Wessner, Czarnikauer Str. 6, 10439 BERLIN, Tyskland (DE)

**(55) Designavbildninger:**

2.1



2.2



2.3



2.4



2.5



2.6



2.7

|      |                          |   |
|------|--------------------------|---|
| (11) | <b>Reg.nr.:</b>          | <b>086394</b>   |
| (21) | <b>Søkn.nr.:</b>         | 20190875  |
| (22) | <b>Inngitt:</b>          | 2019.07.10  |
| (24) | <b>Løpedag:</b>          | 2019.07.10  |
| (43) | <b>Allm. tilgj.:</b>     | 2019.07.16  |
| (15) | <b>Registrert:</b>       | 2019.08.23  |
| (45) | <b>Kunngjort:</b>        | 2019.09.09  |
| (18) | <b>Reg. gjelder til:</b> | 2024.07.10  |
| (73) | <b>Innehaver:</b>        | PETER OPSVIK AS, Pilestredet 27 H, 0164 OSLO, Norge   |
| (74) | <b>Fullmektig:</b>       | ZACCO NORWAY AS, Postboks 2003 Vika, 0125 OSLO, Norge |

**Design 1**

|      |                            |   |
|------|----------------------------|---|
| (54) | <b>Produkt:</b>            | Ryggstøtte for stol [del av stol]         |
| (51) | <b>Klasse:</b>             | 06-06                                     |
| (72) | <b>Designer:</b>           | Peter Opsvik, Pilestredet 27 H, 0164 OSLO |
| (30) | <b>Prioritet:</b>          | 2019.01.16, EM, 006039012, 1              |
| (55) | <b>Designavbildninger:</b> |   |



1.1



1.2



1.3



1.4



1.5



1.6



1.7

- (11) **Reg.nr.:** 086395  
(21) **Søkn.nr.:** 20190460  
(22) **Inngitt:** 2019.05.29  
(24) **Løpedag:** 2019.05.29  
(43) **Allm. tilgj.:** 2019.05.29  
(15) **Registrert:** 2019.08.23  
(45) **Kunngjort:** 2019.09.09  
(18) **Reg. gjelder til:** 2024.05.29  
(73) **Innehaver:** Oslo Taxi AS, Postboks 6538 Rodeløkka, 0501 OSLO, Norge  
(74) **Fullmektig:** BRYN AARFLOT AS, Stortingsgata 8, 0161 OSLO, Norge

**Design 1**

- (54) **Produkt:** Del av bil  
(51) **Klasse:** 12-08  
(72) **Designer:** Cristin Vernan, c/o Oslo Taxi AS Postboks 6538 Rodeløkka, 0501 OSLO  
(50) **Anmerkning:** Designet er i farger  
(55) **Designavbildninger:**

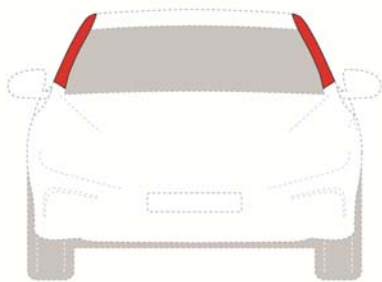

1.1

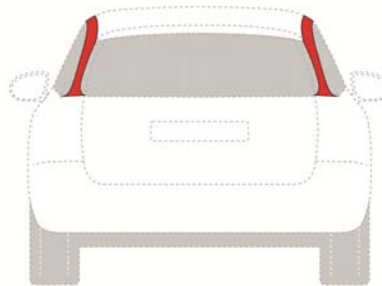

1.2

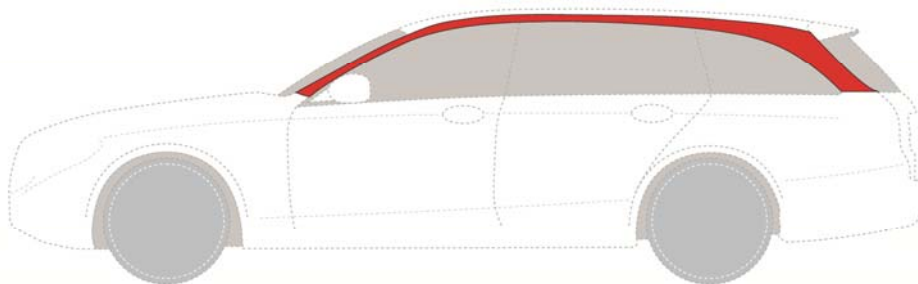

1.3

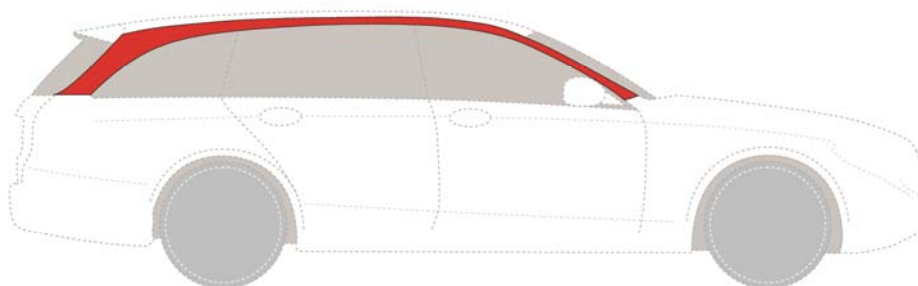

1.4

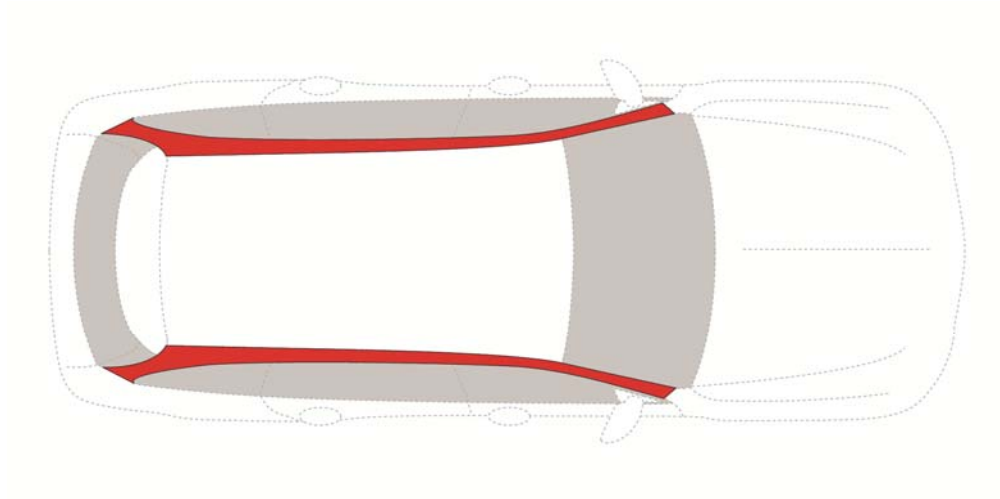

1.5

- (11) **Reg.nr.:** 086396  
(21) **Søkn.nr.:** 20190498  
(22) **Inngitt:** 2019.06.13  
(24) **Løpedag:** 2019.06.13  
(43) **Allm. tilgj.:** 2019.06.13  
(15) **Registrert:** 2019.08.23  
(45) **Kunngjort:** 2019.09.09  
(18) **Reg. gjelder til:** 2024.06.13  
(73) **Innehaver:** METIZO DEZIGN AB, SUNNORPSGATAN 5, 58273 LINKÖPING, Sverige  
(74) **Fullmektig:** SOLVENA PATENT AB, v/ JAN-ERIK LUNDMARK, STJÄRNEVIK SOLVIK, 59046 RIMFORSA, Sverige

**Design 1**

- (54) **Produkt:** Selar bröstselar  
(51) **Klasse:** 30-04  
(72) **Designer:** CARINA LUNDOVIST, RIKSDALERGATAN 39, 58739 LINKÖPING, Sverige (SE)  
(55) **Designavbildninger:**



1.1



1.2

## Internasjonale designregistreringer

I henhold til designloven § 57 fjerde ledd, kunngjøres i dag følgende internasjonale registreringer som har virkning i Norge.

Det kan fremsettes krav om at designregistreringen helt eller delvis skal oppheves, jf. designloven §§ 58 fjerde ledd og 25 flg. og designforskriften §§ 26 flg.

Virkingen av en internasjonal registrering gjelder for den eller de periodene på fem år som søknaden er innlevert for, regnet fra den dagen registreringen ved det Internasjonale byrået anses å ha skjedd. Registreringen kan fornyes etter bestemmelsene i Genèveavtalen, se dl § 58 tredje ledd. Maksimal beskyttelsestid er 25 år.

|      |                                |  |
|------|--------------------------------|--|
| (11) | <b>Reg.nr.:</b>                | <b>DM/200703</b>   |
| (21) | <b>Søkn.nr.:</b>               | 20191079   |
| (22) | <b>Inngitt i WIPO:</b>         | 2019.02.11   |
| (15) | <b>Registrert i WIPO:</b>      | 2019.02.11   |
| (24) | <b>Løpedag:</b>                | 2019.02.11   |
| (43) | <b>Allm. tilgj.:</b>           | 2019.08.16   |
| (15) | <b>Besluttet gjeldende NO:</b> | 2019.08.19   |
| (45) | <b>Kunngjort NO:</b>           | 2019.09.09   |
| (18) | <b>Reg. gjelder til:</b>       | 2024.02.11   |
| (73) | <b>Innehaver:</b>              | HARRY WINSTON SA, Chemin du Tourbillon 8, 1228 PLAN-LES-OUATES, Sveits |
| (50) | <b>Anmerkninger:</b>           | Registreringen gjelder samregistrering.                                |

### Design 1

|      |                            |  |
|------|----------------------------|--|
| (54) | <b>Produkt:</b>            | Finger ring  |
| (51) | <b>Klasse:</b>             | 11-01  |
| (72) | <b>Designer:</b>           | Dominique Riviere, c/o Harry Winston Inc. 718 Fifth Avenue, NY10019 NEW YORK, USA (US) |
| (55) | <b>Designavbildninger:</b> |  |



1.1



1.2



1.3



1.4



1.5



1.6



1.7



1.8

**Design 2**

(54) **Produkt:**

Finger ring

(51) **Klasse:**

11-01

(72) **Designer:**

Rie Yatsugi-Kang, c/o Harry Winston Inc. 718 Fifth Avenue, NY10019 NEW YORK, USA (US)

(55) **Designavbildninger:**



2.1



2.2



2.3



2.4



2.5



2.6



2.7



2.8



2.9

|                              |  |
|------------------------------|--|
| (11) Reg.nr.:                | DM/200896  |
| (21) Søkn.nr.:               | 20191058   |
| (22) Inngitt i WIPO:         | 2019.02.04   |
| (15) Registrert i WIPO:      | 2019.02.04   |
| (24) Løpedag:                | 2019.02.04   |
| (43) Allm. tilgj.:           | 2019.08.09   |
| (15) Besluttet gjeldende NO: | 2019.08.16   |
| (45) Kunngjort NO:           | 2019.09.09   |
| (18) Reg. gjelder til:       | 2024.02.04   |
| (73) Innehaver:              | PSA AUTOMOBILES SA, 2-10 Boulevard de l'Europe, 78300 PARIS, Frankrike |
| (50) Anmerkninger:           | Registreringen gjelder samregistrering.                                |

**Design 1**

|                          |   |
|--------------------------|---|
| (54) Produkt:            | Headlamp for vehicles   |
| (51) Klasse:             | 26-06   |
| (72) Designer:           | Marc Van der Haegen, Bahnhofplatz 1, 65423 RÜSSELSHEIM, Tyskland (DE) |
| (55) Designavbildninger: |   |



1.1



1.2



1.3



1.4



1.5



1.6



1.7



1.8



1.9



1.10



**Design 2**

(54) **Produkt:** Headlamp for vehicles  
 (51) **Klasse:** 26-06  
 (72) **Designer:** Marc Van der Haegen, Bahnhofplatz 1, 65423 RÜSSELSHEIM, Tyskland (DE)  
 (55) **Designavbildninger:**

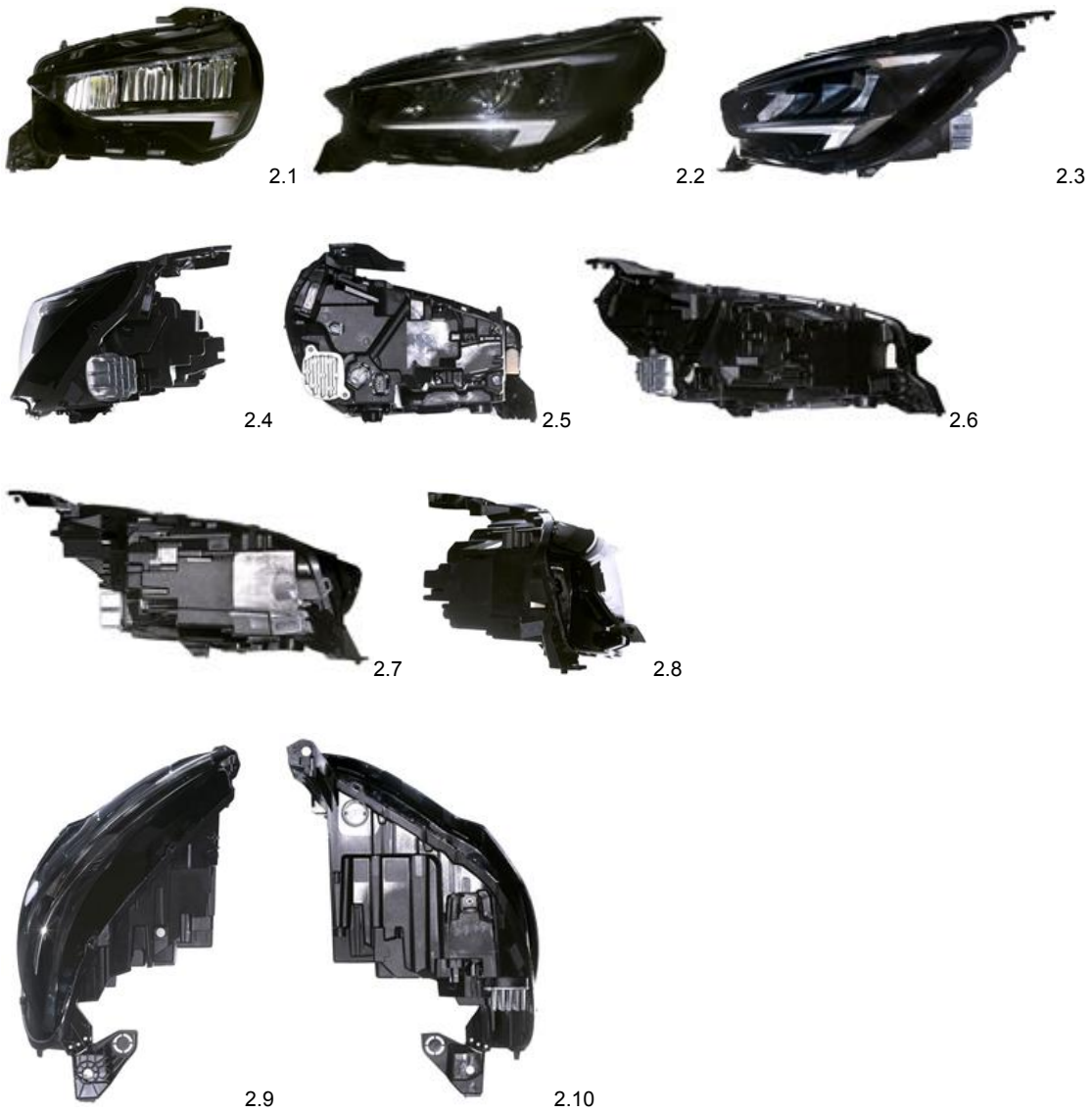

**Design 3**

(54) **Produkt:** Headlamp for vehicles  
 (51) **Klasse:** 26-06  
 (72) **Designer:** Marc Van der Haegen, Bahnhofplatz 1, 65423 RÜSSELSHEIM, Tyskland (DE)  
 (55) **Designavbildninger:**

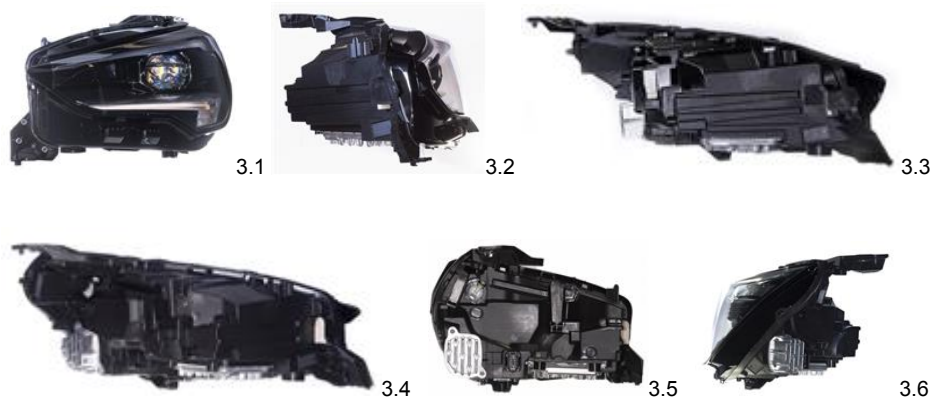



3.7



3.8



3.9



3.10

**Design 4**

- (54) **Produkt:** Taillamp for vehicles  
 (51) **Klasse:** 26-06  
 (72) **Designer:** Marc Van der Haegen, Bahnhofplatz 1, 65423 RÜSSELSHEIM, Tyskland (DE)  
 (50) **Anmerking:** Designet er i farger.  
 (55) **Designavbildninger:**



4.1



4.2



4.3



4.4



4.5



4.6



4.7



4.8



4.9



4.10

**Design 5**

- (54) **Produkt:** Taillamp for vehicles
- (51) **Klasse:** 26-06
- (72) **Designer:** Marc Van der Haegen, Bahnhofplatz 1, 65423 RÜSSELSHEIM, Tyskland (DE)
- (50) **Anmerking:** Designet er i farger.
- (55) **Designavbildninger:**



5.1



5.2



5.3



5.4



5.5



5.6



5.7



5.8



5.9



5.10

**Design 6**

- (54) **Produkt:** Taillamp for vehicles  
(51) **Klasse:** 26-06  
(72) **Designer:** Marc Van der Haegen, Bahnhoofsplatz 1, 65423 RÜSSELSHEIM, Tyskland (DE)  
(50) **Anmerkning:** Designet er i farger.  
(55) **Designavbildninger:**



6.1



6.2



6.3



6.4



6.5



6.6



6.7



6.8



6.9



6.10

**Design 7**

- (54) **Produkt:** Taillamp for vehicles  
(51) **Klasse:** 26-06  
(72) **Designer:** Marc Van der Haegen, Bahnhofplatz 1, 65423 RÜSSELSHEIM, Tyskland (DE)  
(50) **Anmerkning:** Designet er i farger.  
(55) **Designavbildninger:**



|      |                                |   |
|------|--------------------------------|---|
| (11) | <b>Reg.nr.:</b>                | <b>DM/201202</b>  |
| (21) | <b>Søkn.nr.:</b>               | 20191081  |
| (22) | <b>Inngitt i WIPO:</b>         | 2019.02.11  |
| (15) | <b>Registrert i WIPO:</b>      | 2019.02.11  |
| (24) | <b>Løpedag:</b>                | 2019.02.11  |
| (43) | <b>Allm. tilgj.:</b>           | 2019.08.16  |
| (15) | <b>Besluttet gjeldende NO:</b> | 2019.08.19  |
| (45) | <b>Kunngjort NO:</b>           | 2019.09.09  |
| (18) | <b>Reg. gjelder til:</b>       | 2024.02.11  |
| (73) | <b>Innehaver:</b>              | RENAULT s.a.s., 13-15 Quai le Gallo, 92100 BOULOGNE BILLAN COURT, Frankrike |

**Design 1**

|      |                            |   |
|------|----------------------------|---|
| (54) | <b>Produkt:</b>            | Motor vehicle   |
| (51) | <b>Klasse:</b>             | 12-08   |
| (72) | <b>Designer:</b>           | Agneta Dahlgren-Hermine, c/o RENAULT s.a.s, 13-15 quai le Gallo, 92100 BOLOGNE-BILLAN COURT, Frankrike (FR) |
| (50) | <b>Anmerkning:</b>         | Designet er i farger.   |
| (55) | <b>Designavbildninger:</b> |   |



1.1

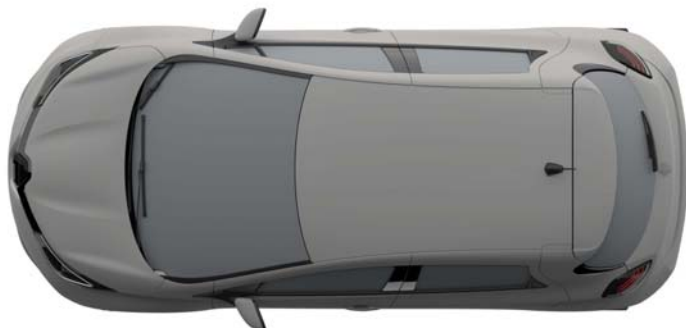

1.2



1.3



1.4



1.5



1.6



1.7



1.8



1.9



1.10

---



|      |                                |   |
|------|--------------------------------|---|
| (11) | <b>Reg.nr.:</b>                | <b>DM/201511</b>  |
| (21) | <b>Søkn.nr.:</b>               | 20190820  |
| (22) | <b>Inngitt i WIPO:</b>         | 2019.03.22  |
| (15) | <b>Registrert i WIPO:</b>      | 2019.03.22  |
| (24) | <b>Løpedag:</b>                | 2019.03.22  |
| (43) | <b>Allm. tilgj.:</b>           | 2019.06.28  |
| (15) | <b>Besluttet gjeldende NO:</b> | 2019.08.14  |
| (45) | <b>Kunngjort NO:</b>           | 2019.09.09  |
| (18) | <b>Reg. gjelder til:</b>       | 2024.03.22  |
| (73) | <b>Innehaver:</b>              | Saverglass, 3 rue de la Gare, 60960 FEUQUIERES, Frankrike |

**Design 1**

|      |                            |  |
|------|----------------------------|--|
| (54) | <b>Produkt:</b>            | Bottle   |
| (51) | <b>Klasse:</b>             | 09-01  |
| (72) | <b>Designer:</b>           | Fraser Reynolds, Basement Studio, 27 All Saints Road, W11 1HE LONDON, Storbritannia (GB) |
| (30) | <b>Prioritet:</b>          | 2018.10.29, EM, 005812062, 1   |
| (55) | <b>Designavbildninger:</b> |  |



1.1



1.2



1.3



1.4



1.5

|                                     |   |
|-------------------------------------|---|
| (11) <b>Reg.nr.:</b>                | <b>DM/201643</b>  |
| (21) <b>Søkn.nr.:</b>               | 20191059  |
| (22) <b>Inngitt i WIPO:</b>         | 2019.02.05  |
| (15) <b>Registrert i WIPO:</b>      | 2019.02.05  |
| (24) <b>Løpedag:</b>                | 2019.02.05  |
| (43) <b>Allm. tilgj.:</b>           | 2019.08.09  |
| (15) <b>Besluttet gjeldende NO:</b> | 2019.08.16  |
| (45) <b>Kunngjort NO:</b>           | 2019.09.09  |
| (18) <b>Reg. gjelder til:</b>       | 2024.02.05  |
| (73) <b>Innehaver:</b>              | HAMAMATSU PHOTONICS K.K., 1126-1, Ichino-cho, Higashi-ku, Hamamatsu-shi, 435-8558 SHIZUOKA, Japan |
| (50) <b>Anmerkninger:</b>           | Registreringen gjelder samregistrering.   |

**Design 1**

|                                 |   |
|---------------------------------|---|
| (54) <b>Produkt:</b>            | Flash Lamp  |
| (51) <b>Klasse:</b>             | 26-04   |
| (72) <b>Designer:</b>           | Yusuke HASEGAWA, c/o Hamamatsu Photonics K.K.1126-1, Ichino-cho, Higashi-ku, Hamamatsu-shi, 435-8558 SHIZUOKA, Japan (JP) |
| (30) <b>Prioritet:</b>          | 2018.10.17, JP, 2018-022759, 1, 7   |
| (55) <b>Designavbildninger:</b> |   |



1.1



1.2



1.3

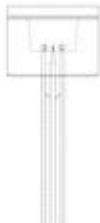

1.4



1.5



1.6



1.7



1.8

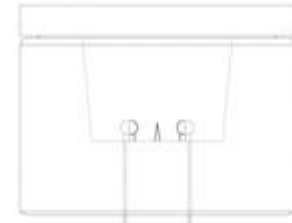

1.9

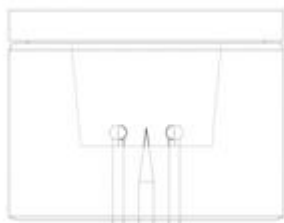

1.10

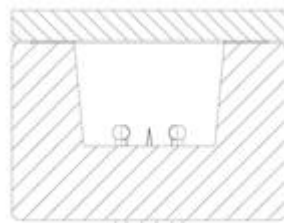

1.11

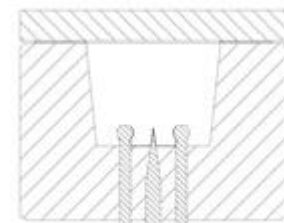

1.12



1.13

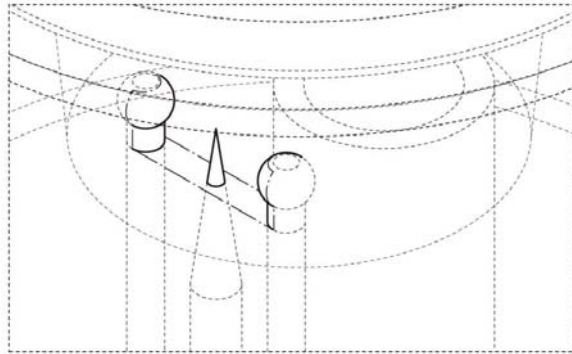

1.14

**Design 2**

- (54) **Produkt:** Flash Lamp
- (51) **Klasse:** 26-04
- (72) **Designer:** Yusuke HASEGAWA, c/o Hamamatsu Photonics K.K.1126-1, Ichino-cho, Higashi-ku, Hamamatsu-shi, 435-8558 SHIZUOKA, Japan (JP)
- (30) **Prioritet:** 2018.10.17, JP, 2018-022760, 2
- (55) **Designavbildninger:**



2.1



2.2



2.3



2.4



2.5



2.6



2.7

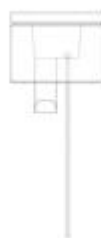

2.8

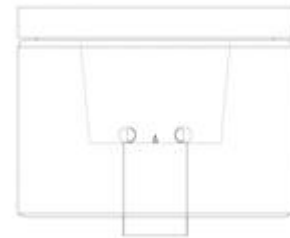

2.9

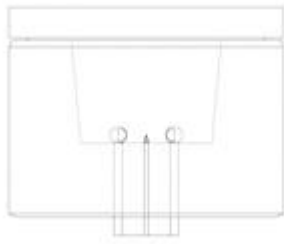

2.10

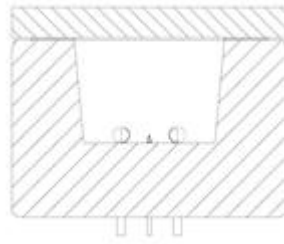

2.11

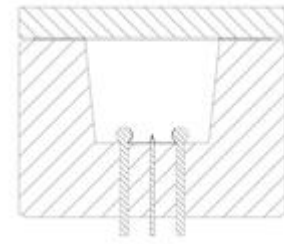

2.12



2.13

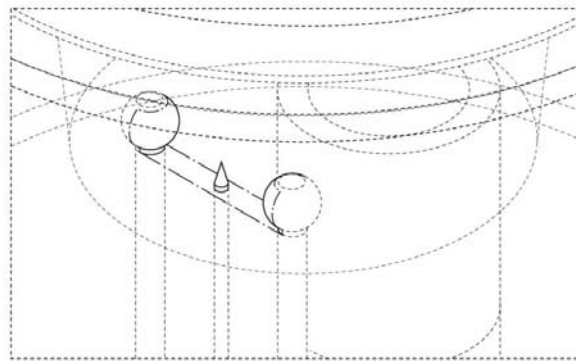

2.14

**Design 3**

- (54) **Produkt:** Flash Lamp
- (51) **Klasse:** 26-04
- (72) **Designer:** Yusuke HASEGAWA, c/o Hamamatsu Photonics K.K.1126-1, Ichino-cho, Higashi-ku, Hamamatsu-shi, 435-8558 SHIZUOKA, Japan (JP)
- (30) **Prioritet:** 2018.10.17, JP, 2018-022761, 3
- (55) **Designavbildninger:**



3.1



3.2



3.3

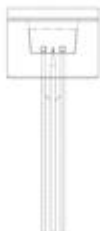

3.4



3.5



3.6

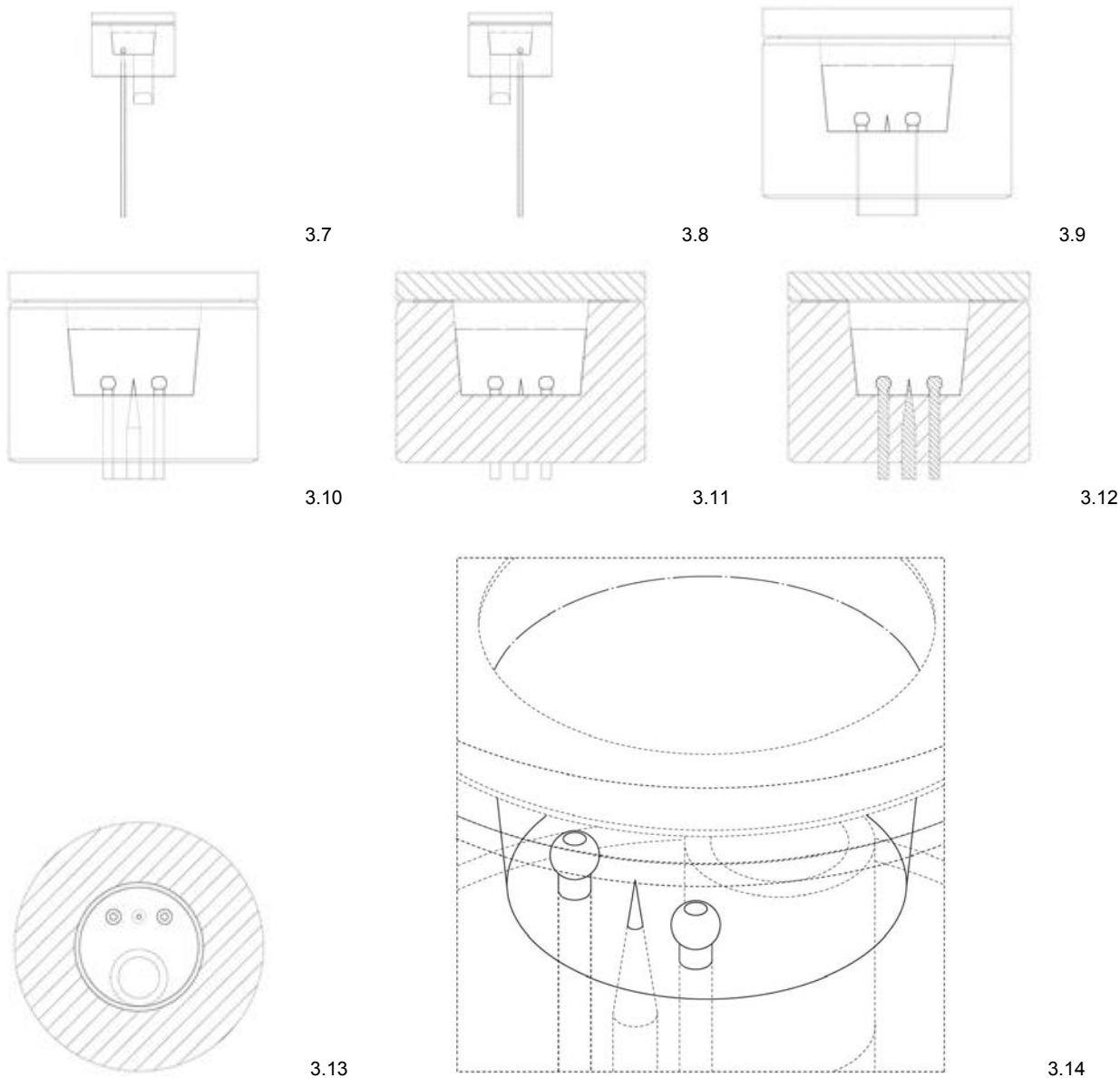

**Design 4**

(54) **Produkt:** Flash Lamp  
 (51) **Klasse:** 26-04  
 (72) **Designer:** Yusuke HASEGAWA, c/o Hamamatsu Photonics K.K.1126-1, Ichino-cho, Higashi-ku, Hamamatsu-shi, 435-8558 SHIZUOKA, Japan (JP)  
 (30) **Prioritet:** 2018.10.17, JP, 2018-022762, 4  
 (55) **Designavbildninger:**

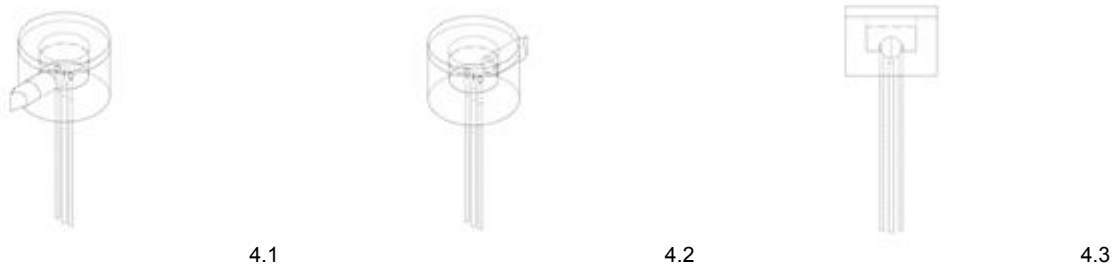



4.4



4.5



4.6



4.7



4.8

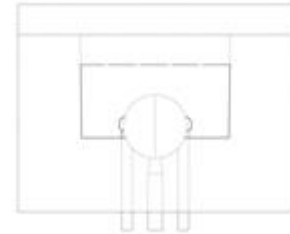

4.9

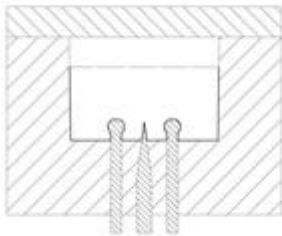

4.10

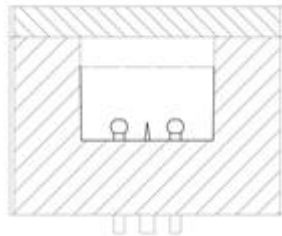

4.11



4.12

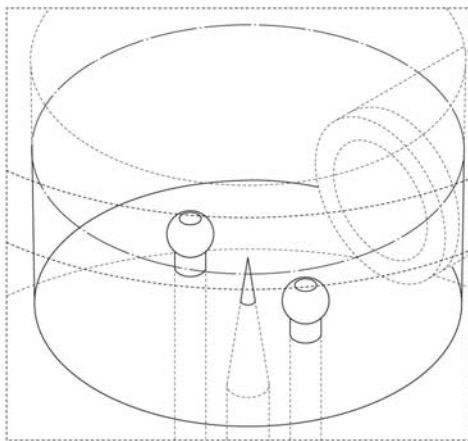

4.13

**Design 5**

(54) **Produkt:** Flash Lamp  
 (51) **Klasse:** 26-04  
 (72) **Designer:** Yusuke HASEGAWA, c/o Hamamatsu Photonics K.K.1126-1, Ichino-cho, Higashi-ku, Hamamatsu-shi, 435-8558 SHIZUOKA, Japan (JP)  
 (30) **Prioritet:** 2018.10.17, JP, 2018-022763, 5  
 (55) **Designavbildninger:**



5.1



5.2

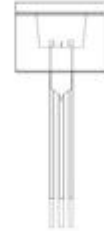

5.3

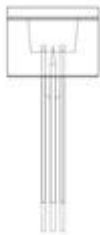

5.4



5.5



5.6



5.7

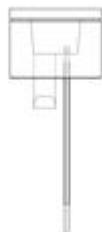

5.8

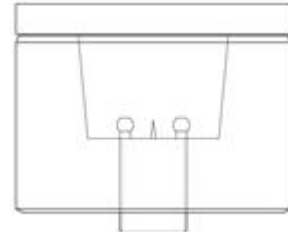

5.9

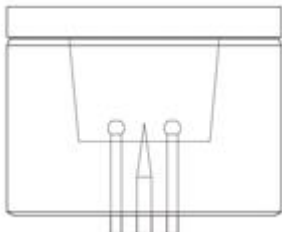

5.10

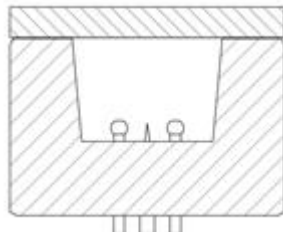

5.11

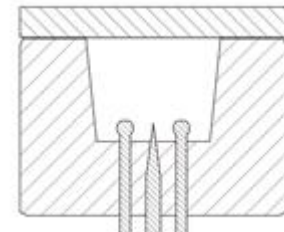

5.12



5.13

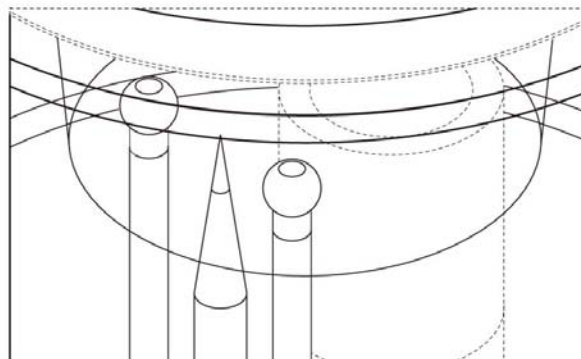

5.14

**Design 6**

(54) **Produkt:** Flash Lamp  
 (51) **Klasse:** 26-04  
 (72) **Designer:** Yusuke HASEGAWA, c/o Hamamatsu Photonics K.K.1126-1, Ichino-cho, Higashi-ku, Hamamatsu-shi, 435-8558 SHIZUOKA, Japan (JP)  
 (30) **Prioritet:** 2018.10.17, JP, 2018-022764, 6  
 (55) **Designavbildninger:**



6.1

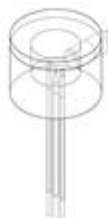

6.2

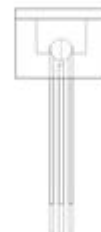

6.3

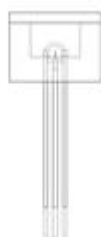

6.4



6.5



6.6



6.7



6.8

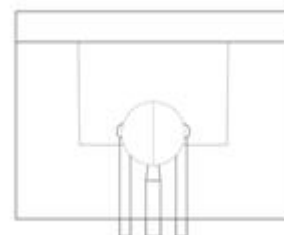

6.9

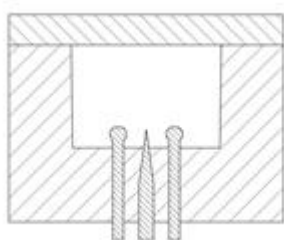

6.10

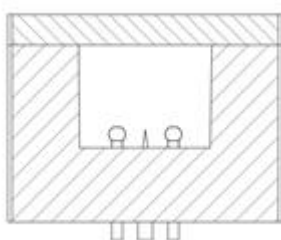

6.11

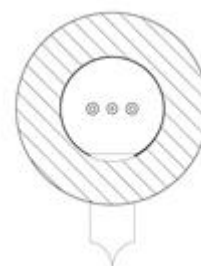

6.12

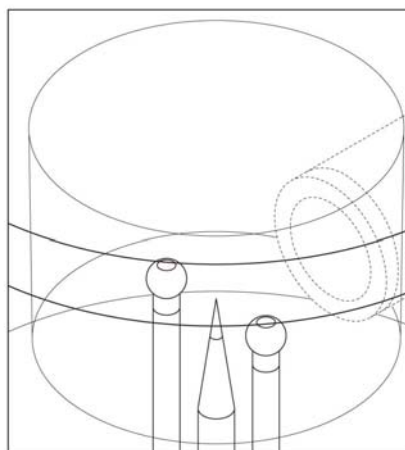

6.13



**Design 7**

(54) **Produkt:** Flash Lamp  
 (51) **Klasse:** 26-04  
 (72) **Designer:** Yusuke HASEGAWA, c/o Hamamatsu Photonics K.K.1126-1, Ichino-cho, Higashi-ku, Hamamatsu-shi, 435-8558 SHIZUOKA, Japan (JP)  
 (30) **Prioritet:** 2018.10.17, JP, 2018-022759, 1, 7  
 (55) **Designavbildninger:**



7.1



7.2

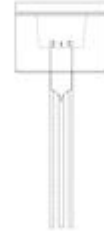

7.3



7.4



7.5



7.6



7.7

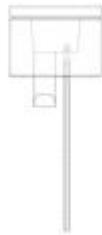

7.8

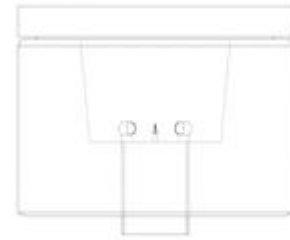

7.9

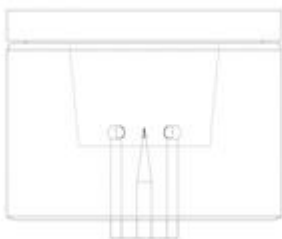

7.10

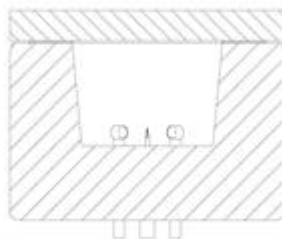

7.11

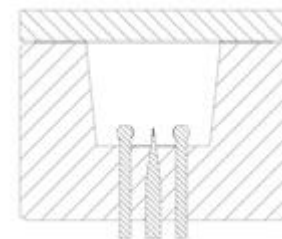

7.12



7.13

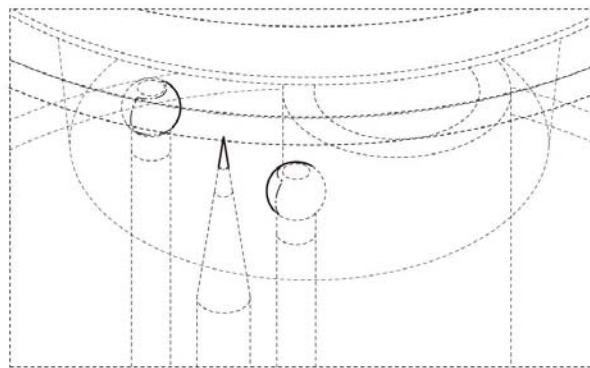

7.14

|      |                                |  |
|------|--------------------------------|--|
| (11) | <b>Reg.nr.:</b>                | <b>DM/201663</b>   |
| (21) | <b>Søkn.nr.:</b>               | 20190856   |
| (22) | <b>Inngitt i WIPO:</b>         | 2019.04.15   |
| (15) | <b>Registrert i WIPO:</b>      | 2019.04.15   |
| (24) | <b>Løpedag:</b>                | 2019.04.15   |
| (43) | <b>Allm. tilgj.:</b>           | 2019.07.05   |
| (15) | <b>Besluttet gjeldende NO:</b> | 2019.08.19   |
| (45) | <b>Kunngjort NO:</b>           | 2019.09.09   |
| (18) | <b>Reg. gjelder til:</b>       | 2024.04.15   |
| (73) | <b>Innehaver:</b>              | Teqball Holding SARL, 44 avenue John F. Kennedy, 1855 LUXEMBOURG, Luxembourg |
| (50) | <b>Anmerkninger:</b>           | Registreringen gjelder samregistrering.                                      |

**Design 1**

|      |                            |       |
|------|----------------------------|-------|
| (54) | <b>Produkt:</b>            | Logo  |
| (51) | <b>Klasse:</b>             | 32-00 |
| (72) | <b>Designer:</b>           |       |
| (55) | <b>Designavbildninger:</b> |       |



1.1

**Design 2**

|      |                            |                       |
|------|----------------------------|-----------------------|
| (54) | <b>Produkt:</b>            | Logo                  |
| (51) | <b>Klasse:</b>             | 32-00                 |
| (72) | <b>Designer:</b>           |                       |
| (50) | <b>Anmerking:</b>          | Designet er i farger. |
| (55) | <b>Designavbildninger:</b> |                       |



2.1

**Design 3**

|      |                            |                       |
|------|----------------------------|-----------------------|
| (54) | <b>Produkt:</b>            | Logo                  |
| (51) | <b>Klasse:</b>             | 32-00                 |
| (72) | <b>Designer:</b>           |                       |
| (50) | <b>Anmerking:</b>          | Designet er i farger. |
| (55) | <b>Designavbildninger:</b> |                       |



3.1

**Design 4**

- (54) **Produkt:** Logo  
(51) **Klasse:** 32-00  
(72) **Designer:**  
(50) **Anmerkning:** Designet er i farger.  
(55) **Designavbildninger:**



4.1

**Design 5**

- (54) **Produkt:** Logo  
(51) **Klasse:** 32-00  
(72) **Designer:**  
(50) **Anmerkning:** Designet er i farger.  
(55) **Designavbildninger:**



5.1

**Design 6**

- (54) **Produkt:** Logo  
(51) **Klasse:** 32-00  
(72) **Designer:**  
(50) **Anmerkning:** Designet er i farger.  
(55) **Designavbildninger:**



6.1

|      |                                |   |
|------|--------------------------------|---|
| (11) | <b>Reg.nr.:</b>                | <b>DM/201753</b>  |
| (21) | <b>Søkn.nr.:</b>               | 20191060  |
| (22) | <b>Inngitt i WIPO:</b>         | 2019.06.06  |
| (15) | <b>Registrert i WIPO:</b>      | 2019.06.06  |
| (24) | <b>Løpedag:</b>                | 2019.06.06  |
| (43) | <b>Allm. tilgj.:</b>           | 2019.08.09  |
| (15) | <b>Besluttet gjeldende NO:</b> | 2019.08.16  |
| (45) | <b>Kunngjort NO:</b>           | 2019.09.09  |
| (18) | <b>Reg. gjelder til:</b>       | 2024.06.06  |
| (73) | <b>Innehaver:</b>              | Koninklijke Philips N.V., High Tech Campus 5, 5656AE EINDHOVEN, Nederland |

**Design 1**

|      |                            |  |
|------|----------------------------|--|
| (54) | <b>Produkt:</b>            | Charger base for baby monitor  |
| (51) | <b>Klasse:</b>             | 13-02  |
| (72) | <b>Designer:</b>           | Emma Stina Katarina Sandberg, Flat B 33 Vinkenstraat, 1013JL AMSTERDAM, Nederland (NL) |
| (55) | <b>Designavbildninger:</b> |  |

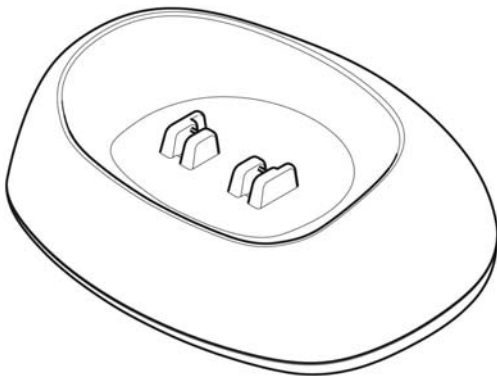

1.1

|                                     |   |
|-------------------------------------|---|
| (11) <b>Reg.nr.:</b>                | <b>DM/201808</b>  |
| (21) <b>Søkn.nr.:</b>               | 20191061  |
| (22) <b>Inngitt i WIPO:</b>         | 2019.02.08  |
| (15) <b>Registrert i WIPO:</b>      | 2019.02.08  |
| (24) <b>Løpedag:</b>                | 2019.02.08  |
| (43) <b>Allm. tilgj.:</b>           | 2019.08.09  |
| (15) <b>Besluttet gjeldende NO:</b> | 2019.08.16  |
| (45) <b>Kunngjort NO:</b>           | 2019.09.09  |
| (18) <b>Reg. gjelder til:</b>       | 2024.02.08  |
| (73) <b>Innehaver:</b>              | Sepro Robotique, Rue Bessemer - Z.I Les Ajoncs, 85000 LA ROCHE SUR YON, Frankrike |
| (50) <b>Anmerkninger:</b>           | Registreringen gjelder samregistrering.   |

**Design 1**

|                                 |  |
|---------------------------------|--|
| (54) <b>Produkt:</b>            | Control unit for a robot   |
| (51) <b>Klasse:</b>             | 14-03<br>14-04   |
| (72) <b>Designer:</b>           | Jean-Michel RENAUDEAU, Rue Bessemer, ZI Les Ajoncs, 85000 LA ROCHE-SUR-YON, Frankrike (FR) |
| (55) <b>Designavbildninger:</b> |  |

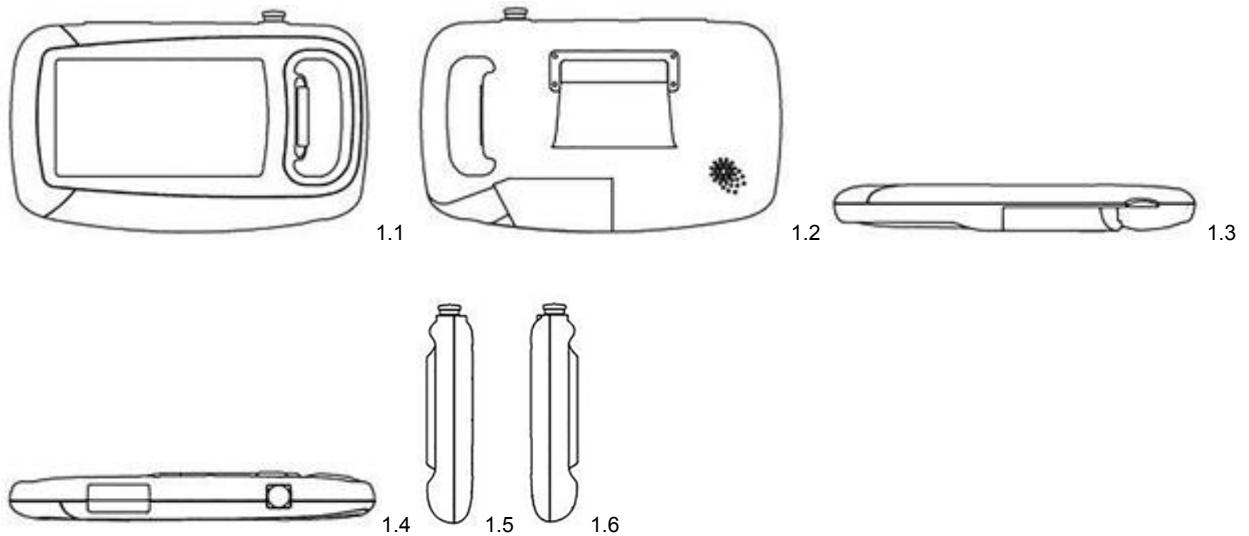
**Design 2**

|                                 |   |
|---------------------------------|---|
| (54) <b>Produkt:</b>            | Graphical user interface of a control unit for a robot  |
| (51) <b>Klasse:</b>             | 14-03<br>14-04  |
| (72) <b>Designer:</b>           | Xavier ONTENIENTE, 10 rue de la Fontaine, 85210 LA CHAPELLE-THEMER, Frankrike (FR)<br>Cédric PERLES, 4 rue des Noisetiers, 85170 BEAUFOU, Frankrike (FR)<br>Nathalie BOCQUIER, Rue Bessemer, ZI Les Ajoncs., 85000 LA ROCHE-SUR-YON, Frankrike (FR) |
| (55) <b>Designavbildninger:</b> |   |



2.1

**Design 3**

- (54) **Produkt:** Graphical user interface of a control unit for a robot  
(51) **Klasse:** 14-03  
14-04  
(72) **Designer:** Xavier ONTENIENTE, 10 rue de la Fontaine, 85210 LA CHAPELLE-THEMER, Frankrike (FR)  
Cédric PERLES, 4 rue des Noisetiers, 85170 BEAUFOU, Frankrike (FR)  
Nathalie BOCQUIER, Rue Bessemer, ZI Les Ajoncs., 85000 LA ROCHE-SUR-YON, Frankrike (FR)  
(55) **Designavbildninger:**



3.1

**Design 4**

- (54) **Produkt:** Graphical user interface of a control unit for a robot  
(51) **Klasse:** 14-03  
14-04  
(72) **Designer:** Xavier ONTENIENTE, 10 rue de la Fontaine, 85210 LA CHAPELLE-THEMER, Frankrike (FR)  
Cédric PERLES, 4 rue des Noisetiers, 85170 BEAUFOU, Frankrike (FR)  
Nathalie BOCQUIER, Rue Bessemer, ZI Les Ajoncs., 85000 LA ROCHE-SUR-YON, Frankrike (FR)  
(55) **Designavbildninger:**



4.1

**Design 5**

- (54) **Produkt:** Graphical user interface of a control unit for a robot  
(51) **Klasse:** 14-03  
14-04  
(72) **Designer:** Xavier ONTENIENTE, 10 rue de la Fontaine, 85210 LA CHAPELLE-THEMER, Frankrike (FR)  
Cédric PERLES, 4 rue des Noisetiers, 85170 BEAUFOU, Frankrike (FR)  
Nathalie BOCQUIER, Rue Bessemer, ZI Les Ajoncs., 85000 LA ROCHE-SUR-YON, Frankrike (FR)  
(55) **Designavbildninger:**

**Design 6**

- (54) **Produkt:** Graphical user interface of a control unit for a robot  
(51) **Klasse:** 14-03  
14-04  
(72) **Designer:** Xavier ONTENIENTE, 10 rue de la Fontaine, 85210 LA CHAPELLE-THEMER, Frankrike (FR)  
Cédric PERLES, 4 rue des Noisetiers, 85170 BEAUFOU, Frankrike (FR)  
Nathalie BOCQUIER, Rue Bessemer, ZI Les Ajoncs., 85000 LA ROCHE-SUR-YON, Frankrike (FR)  
(55) **Designavbildninger:**



**Design 7**

- (54) **Produkt:** Graphical user interface of a control unit for a robot  
(51) **Klasse:** 14-03  
14-04  
(72) **Designer:** Xavier ONTENIENTE, 10 rue de la Fontaine, 85210 LA CHAPELLE-THEMER, Frankrike (FR)  
Cédric PERLES, 4 rue des Noisetiers, 85170 BEAUFOU, Frankrike (FR)  
Nathalie BOCQUIER, Rue Bessemer, ZI Les Ajoncs., 85000 LA ROCHE-SUR-YON, Frankrike (FR)  
(55) **Designavbildninger:**



7.1

**Design 8**

- (54) **Produkt:** Graphical user interface of a control unit for a robot  
(51) **Klasse:** 14-03  
14-04  
(72) **Designer:** Xavier ONTENIENTE, 10 rue de la Fontaine, 85210 LA CHAPELLE-THEMER, Frankrike (FR)  
Cédric PERLES, 4 rue des Noisetiers, 85170 BEAUFOU, Frankrike (FR)  
Nathalie BOCQUIER, Rue Bessemer, ZI Les Ajoncs., 85000 LA ROCHE-SUR-YON, Frankrike (FR)  
(55) **Designavbildninger:**



8.1



**Design 9**

- (54) **Produkt:** Graphical user interface of a control unit for a robot  
(51) **Klasse:** 14-03  
14-04  
(72) **Designer:** Xavier ONTENIENTE, 10 rue de la Fontaine, 85210 LA CHAPELLE-THEMER, Frankrike (FR)  
Cédric PERLES, 4 rue des Noisetiers, 85170 BEAUFOU, Frankrike (FR)  
Nathalie BOCQUIER, Rue Bessemer, ZI Les Ajoncs., 85000 LA ROCHE-SUR-YON, Frankrike (FR)  
(55) **Designavbildninger:**

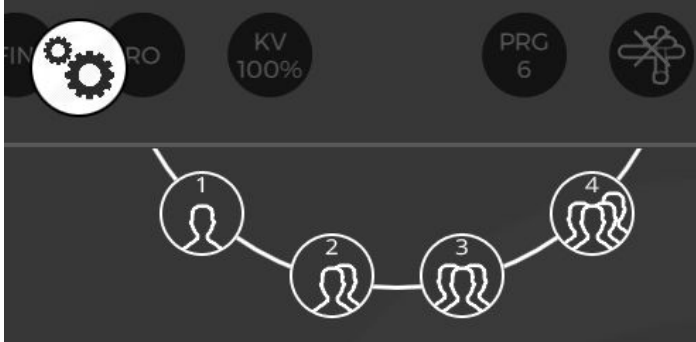
**Design 10**

- (54) **Produkt:** Graphical user interface of a control unit for a robot  
(51) **Klasse:** 14-03  
14-04  
(72) **Designer:** Xavier ONTENIENTE, 10 rue de la Fontaine, 85210 LA CHAPELLE-THEMER, Frankrike (FR)  
Cédric PERLES, 4 rue des Noisetiers, 85170 BEAUFOU, Frankrike (FR)  
Nathalie BOCQUIER, Rue Bessemer, ZI Les Ajoncs., 85000 LA ROCHE-SUR-YON, Frankrike (FR)  
(55) **Designavbildninger:**



|                                     |  |
|-------------------------------------|--|
| (11) <b>Reg.nr.:</b>                | <b>DM/201942</b>   |
| (21) <b>Søkn.nr.:</b>               | 20190923   |
| (22) <b>Inngitt i WIPO:</b>         | 2019.06.07   |
| (15) <b>Registrert i WIPO:</b>      | 2019.06.07   |
| (24) <b>Løpedag:</b>                | 2019.06.07   |
| (43) <b>Allm. tilgj.:</b>           | 2019.07.19   |
| (15) <b>Besluttet gjeldende NO:</b> | 2019.08.12   |
| (45) <b>Kunngjort NO:</b>           | 2019.09.09   |
| (18) <b>Reg. gjelder til:</b>       | 2024.06.07   |
| (73) <b>Innehaver:</b>              | Sino Pro Trading B.V., Tilburgse Weg 58, 4092 TM OOSTERHOUT, Nederland |
| (50) <b>Anmerkninger:</b>           | Registreringen gjelder bare samregistrering.                           |

**Design 1**

|                                 |   |
|---------------------------------|---|
| (54) <b>Produkt:</b>            | Shoe  |
| (51) <b>Klasse:</b>             | 02-04   |
| (72) <b>Designer:</b>           | Filip Rasschaert, Tai Pak Terrace 8 C, Sands Street 34 KENNEDY TOWN, Hong Kong (HK)<br>Sandro Avanzini, Via Prà dei Prà, 8, 37057 SAN GIOVANNI LUPATOTO (VERONA), Italia (IT) |
| (30) <b>Prioritet:</b>          | 2019.02.06, EM, 006177010, 1, 2, 3, 4, 5, 6, 7, 8   |
| (55) <b>Designavbildninger:</b> |   |



1.1

**Design 2**

|                                 |   |
|---------------------------------|---|
| (54) <b>Produkt:</b>            | Shoe  |
| (51) <b>Klasse:</b>             | 02-04   |
| (72) <b>Designer:</b>           | Filip Rasschaert, Tai Pak Terrace 8 C, Sands Street 34 KENNEDY TOWN, Hong Kong (HK)<br>Sandro Avanzini, Via Prà dei Prà, 8, 37057 SAN GIOVANNI LUPATOTO (VERONA), Italia (IT) |
| (30) <b>Prioritet:</b>          | 2019.02.06, EM, 006177010, 1, 2, 3, 4, 5, 6, 7, 8   |
| (55) <b>Designavbildninger:</b> |   |



2.1

**Design 3**

- (54) **Produkt:** Shoe  
(51) **Klasse:** 02-04  
(72) **Designer:** Filip Rasschaert, Tai Pak Terrace 8 C, Sands Street 34 KENNEDY TOWN, Hong Kong (HK)  
Sandro Avanzini, Via Prà dei Prà, 8, 37057 SAN GIOVANNI LUPATOTO (VERONA), Italia (IT)  
(30) **Prioritet:** 2019.02.06, EM, 006177010, 1, 2, 3, 4, 5, 6, 7, 8  
(55) **Designavbildninger:**

**Design 4**

- (54) **Produkt:** Shoe  
(51) **Klasse:** 02-04  
(72) **Designer:** Filip Rasschaert, Tai Pak Terrace 8 C, Sands Street 34 KENNEDY TOWN, Hong Kong (HK)  
Sandro Avanzini, Via Prà dei Prà, 8, 37057 SAN GIOVANNI LUPATOTO (VERONA), Italia (IT)  
(30) **Prioritet:** 2019.02.06, EM, 006177010, 1, 2, 3, 4, 5, 6, 7, 8  
(55) **Designavbildninger:**

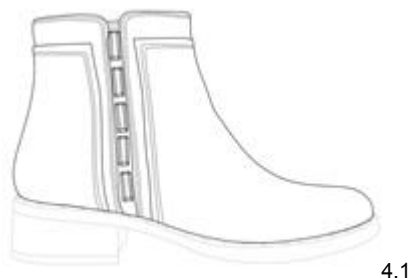
**Design 5**

- (54) **Produkt:** Shoe  
(51) **Klasse:** 02-04  
(72) **Designer:** Filip Rasschaert, Tai Pak Terrace 8 C, Sands Street 34 KENNEDY TOWN, Hong Kong (HK)  
Sandro Avanzini, Via Prà dei Prà, 8, 37057 SAN GIOVANNI LUPATOTO (VERONA), Italia (IT)  
(30) **Prioritet:** 2019.02.06, EM, 006177010, 1, 2, 3, 4, 5, 6, 7, 8  
(55) **Designavbildninger:**



**Design 6**

- (54) **Produkt:** Shoe  
(51) **Klasse:** 02-04  
(72) **Designer:** Filip Rasschaert, Tai Pak Terrace 8 C, Sands Street 34 KENNEDY TOWN, Hong Kong (HK)  
Sandro Avanzini, Via Prà dei Prà, 8, 37057 SAN GIOVANNI LUPATOTO (VERONA), Italia (IT)  
(30) **Prioritet:** 2019.02.06, EM, 006177010, 1, 2, 3, 4, 5, 6, 7, 8  
(55) **Designavbildninger:**



6.1

**Design 7**

- (54) **Produkt:** Shoe  
(51) **Klasse:** 02-04  
(72) **Designer:** Filip Rasschaert, Tai Pak Terrace 8 C, Sands Street 34 KENNEDY TOWN, Hong Kong (HK)  
Sandro Avanzini, Via Prà dei Prà, 8, 37057 SAN GIOVANNI LUPATOTO (VERONA), Italia (IT)  
(30) **Prioritet:** 2019.02.06, EM, 006177010, 1, 2, 3, 4, 5, 6, 7, 8  
(55) **Designavbildninger:**

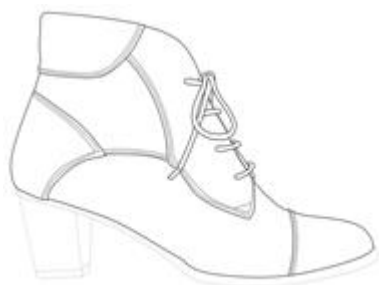

7.1

**Design 8**

- (54) **Produkt:** Shoe  
(51) **Klasse:** 02-04  
(72) **Designer:** Filip Rasschaert, Tai Pak Terrace 8 C, Sands Street 34 KENNEDY TOWN, Hong Kong (HK)  
Sandro Avanzini, Via Prà dei Prà, 8, 37057 SAN GIOVANNI LUPATOTO (VERONA), Italia (IT)  
(30) **Prioritet:** 2019.02.06, EM, 006177010, 1, 2, 3, 4, 5, 6, 7, 8  
(55) **Designavbildninger:**



8.1

|      |                                |  |
|------|--------------------------------|--|
| (11) | <b>Reg.nr.:</b>                | <b>DM/201943</b>   |
| (21) | <b>Søkn.nr.:</b>               | 20190924   |
| (22) | <b>Inngitt i WIPO:</b>         | 2019.06.05   |
| (15) | <b>Registrert i WIPO:</b>      | 2019.06.05   |
| (24) | <b>Løpedag:</b>                | 2019.06.05   |
| (43) | <b>Allm. tilgj.:</b>           | 2019.07.19   |
| (15) | <b>Besluttet gjeldende NO:</b> | 2019.08.12   |
| (45) | <b>Kunngjort NO:</b>           | 2019.09.09   |
| (18) | <b>Reg. gjelder til:</b>       | 2024.06.05   |
| (73) | <b>Innehaver:</b>              | Sino Pro Trading B.V., Tilburgse Weg 58, 4092 TM OOSTERHOUT, Nederland |
| (50) | <b>Anmerkninger:</b>           | Registreringen gjelder samregistrering.                                |

**Design 1**

|      |                            |   |
|------|----------------------------|---|
| (54) | <b>Produkt:</b>            | Shoe  |
| (51) | <b>Klasse:</b>             | 02-04   |
| (72) | <b>Designer:</b>           | Filip Rasschaert, Tai Pak Terrace 8 C, Sands Street 34 KENNEDY TOWN, Hong Kong (HK)<br>Sandro Avanzini, Via Prà dei Prà, 8, 37057 SAN GIOVANNI LUPATOTO (VERONA), Italia (IT) |
| (30) | <b>Prioritet:</b>          | 2018.12.20, EM, 005939931, 1, 2   |
| (55) | <b>Designavbildninger:</b> |   |

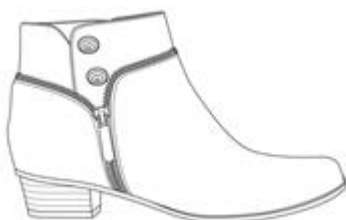

1.1

**Design 2**

|      |                            |   |
|------|----------------------------|---|
| (54) | <b>Produkt:</b>            | Part of shoe  |
| (51) | <b>Klasse:</b>             | 02-04   |
| (72) | <b>Designer:</b>           | Filip Rasschaert, Tai Pak Terrace 8 C, Sands Street 34 KENNEDY TOWN, Hong Kong (HK)<br>Sandro Avanzini, Via Prà dei Prà, 8, 37057 SAN GIOVANNI LUPATOTO (VERONA), Italia (IT) |
| (30) | <b>Prioritet:</b>          | 2018.12.20, EM, 005939931, 1, 2   |
| (55) | <b>Designavbildninger:</b> |   |



2.1

|      |                                |  |
|------|--------------------------------|--|
| (11) | <b>Reg.nr.:</b>                | <b>DM/202146</b>   |
| (21) | <b>Søkn.nr.:</b>               | 20191062   |
| (22) | <b>Inngitt i WIPO:</b>         | 2019.07.12   |
| (15) | <b>Registrert i WIPO:</b>      | 2019.07.12   |
| (24) | <b>Løpedag:</b>                | 2019.07.12   |
| (43) | <b>Allm. tilgj.:</b>           | 2019.08.09   |
| (15) | <b>Besluttet gjeldende NO:</b> | 2019.08.16   |
| (45) | <b>Kunngjort NO:</b>           | 2019.09.09   |
| (18) | <b>Reg. gjelder til:</b>       | 2024.07.12   |
| (73) | <b>Innehaver:</b>              | Bugatti International S.A., 412F route d'Esch, 1030 LUXEMBOURG, Luxembourg |
| (50) | <b>Anmerkninger:</b>           | Registreringen gjelder samregistrering.                                    |

**Design 1**

|      |                            |                                  |
|------|----------------------------|----------------------------------|
| (54) | <b>Produkt:</b>            | Front lights for vehicles        |
| (51) | <b>Klasse:</b>             | 26-06                            |
| (72) | <b>Designer:</b>           |                                  |
| (30) | <b>Prioritet:</b>          | 2019.03.04, EM, 6275244, 1, 2, 3 |
| (55) | <b>Designavbildninger:</b> |                                  |



1.1



1.2



1.3

**Design 2**

|      |                            |                                  |
|------|----------------------------|----------------------------------|
| (54) | <b>Produkt:</b>            | Front lights for vehicles        |
| (51) | <b>Klasse:</b>             | 26-06                            |
| (72) | <b>Designer:</b>           |                                  |
| (30) | <b>Prioritet:</b>          | 2019.03.04, EM, 6275244, 1, 2, 3 |
| (55) | <b>Designavbildninger:</b> |                                  |



2.1



2.2



2.3

**Design 3**

|      |                            |                                  |
|------|----------------------------|----------------------------------|
| (54) | <b>Produkt:</b>            | Rear light for vehicles          |
| (51) | <b>Klasse:</b>             | 26-06                            |
| (72) | <b>Designer:</b>           |                                  |
| (30) | <b>Prioritet:</b>          | 2019.03.04, EM, 6275244, 1, 2, 3 |
| (50) | <b>Anmerkning:</b>         | Designet er i farger.            |
| (55) | <b>Designavbildninger:</b> |                                  |



3.1



3.2



3.3



3.4

|                                     |  |
|-------------------------------------|--|
| (11) <b>Reg.nr.:</b>                | <b>DM/202151</b>   |
| (21) <b>Søkn.nr.:</b>               | 20191063   |
| (22) <b>Inngitt i WIPO:</b>         | 2019.01.04   |
| (15) <b>Registrert i WIPO:</b>      | 2019.01.04   |
| (24) <b>Løpedag:</b>                | 2019.01.04   |
| (43) <b>Allm. tilgj.:</b>           | 2019.08.09   |
| (15) <b>Besluttet gjeldende NO:</b> | 2019.08.16   |
| (45) <b>Kunngjort NO:</b>           | 2019.09.09   |
| (18) <b>Reg. gjelder til:</b>       | 2024.01.04   |
| (73) <b>Innehaver:</b>              | MBG International Premium Brands GmbH, Oberes Feld 13, 33106 PADERBORN, Tyskland |
| (50) <b>Anmerkninger:</b>           | Registreringen gjelder samregistrering.  |

**Design 1**

|                                 |  |
|---------------------------------|--|
| (54) <b>Produkt:</b>            | Beverage bottle  |
| (51) <b>Klasse:</b>             | 09-01  |
| (72) <b>Designer:</b>           | Andreas Werner Herb, Busdorfwall 18a, 33098 PADERBORN, Tyskland (DE) |
| (50) <b>Anmerkning:</b>         | Designet er i farger.  |
| (55) <b>Designavbildninger:</b> |  |



1.1

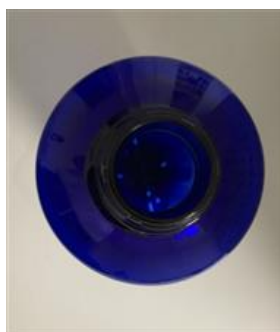

1.2



1.3

**Design 2**

- (54) **Produkt:** Beverage bottle  
(51) **Klasse:** 09-01  
(72) **Designer:** Andreas Werner Herb, Busdorfwall 18a, 33098 PADERBORN, Tyskland (DE)  
(50) **Anmerkning:** Designet er i farger.  
(55) **Designavbildninger:**



2.1



2.2

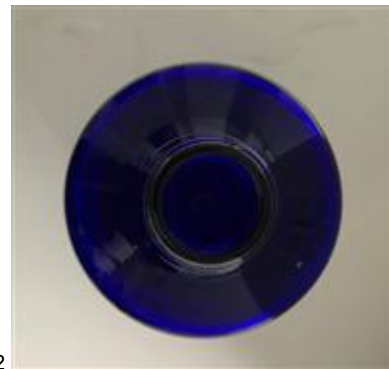

2.3

**Design 3**

- (54) **Produkt:** Beverage bottle  
(51) **Klasse:** 09-01  
(72) **Designer:** Andreas Werner Herb, Busdorfwall 18a, 33098 PADERBORN, Tyskland (DE)  
(50) **Anmerkning:** Designet er i farger.  
(55) **Designavbildninger:**



3.1





3.2



3.3

**Design 4**

- (54) **Produkt:** Beverage bottle  
(51) **Klasse:** 09-01  
(72) **Designer:** Andreas Werner Herb, Busdorfwall 18a, 33098 PADERBORN, Tyskland (DE)  
(50) **Anmerkning:** Designet er i farger.  
(55) **Designavbildninger:**



4.1



4.2



4.3

**Design 5**

- (54) **Produkt:** Beverage bottle  
(51) **Klasse:** 09-01  
(72) **Designer:** Andreas Werner Herb, Busdorfwall 18a, 33098 PADERBORN, Tyskland (DE)  
(50) **Anmerkning:** Designet er i farger.  
(55) **Designavbildninger:**



5.1



5.2



5.3

**Design 6**

- (54) **Produkt:** Beverage bottle  
(51) **Klasse:** 09-01  
(72) **Designer:** Andreas Werner Herb, Busdorfwall 18a, 33098 PADERBORN, Tyskland (DE)  
(55) **Designavbildninger:**



6.1

**Design 7**

- (54) **Produkt:** Beverage bottle  
(51) **Klasse:** 09-01  
(72) **Designer:** Andreas Werner Herb, Busdorfwall 18a, 33098 PADERBORN, Tyskland (DE)  
(55) **Designavbildninger:**

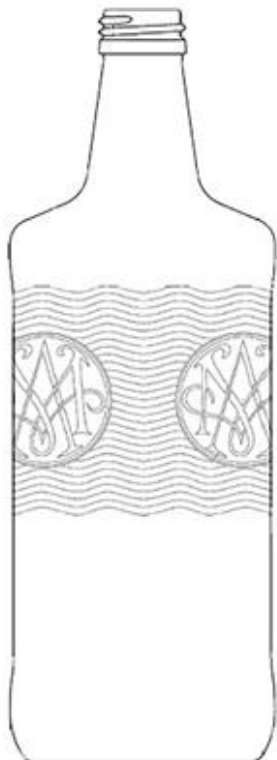

7.1

**Design 8**

- (54) **Produkt:** Beverage bottle  
(51) **Klasse:** 09-01  
(72) **Designer:** Andreas Werner Herb, Busdorfwall 18a, 33098 PADERBORN, Tyskland (DE)  
(55) **Designavbildninger:**



8.1

**Design 9**

- (54) **Produkt:** Beverage bottle  
(51) **Klasse:** 09-01  
(72) **Designer:** Andreas Werner Herb, Busdorfwall 18a, 33098 PADERBORN, Tyskland (DE)  
(55) **Designavbildninger:**



9.1

**Design 10**

- (54) **Produkt:** Beverage bottle  
(51) **Klasse:** 09-01  
(72) **Designer:** Andreas Werner Herb, Busdorfwall 18a, 33098 PADERBORN, Tyskland (DE)  
(30) **Prioritet:** 2018.07.05, EM, 005425006, 10  
(55) **Designavbildninger:**

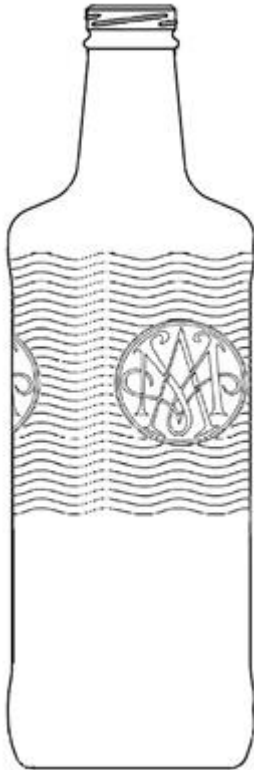

10.1

|      |                                |                                     |
|------|--------------------------------|-------------------------------------|
| (11) | <b>Reg.nr.:</b>                | <b>DM/202154</b>                    |
| (21) | <b>Søkn.nr.:</b>               | 20191064                            |
| (22) | <b>Inngitt i WIPO:</b>         | 2019.07.10                          |
| (15) | <b>Registrert i WIPO:</b>      | 2019.07.10                          |
| (24) | <b>Løpedag:</b>                | 2019.07.10                          |
| (43) | <b>Allm. tilgj.:</b>           | 2019.08.09                          |
| (15) | <b>Besluttet gjeldende NO:</b> | 2019.08.16                          |
| (45) | <b>Kunngjort NO:</b>           | 2019.09.09                          |
| (18) | <b>Reg. gjelder til:</b>       | 2024.07.10                          |
| (73) | <b>Innehaver:</b>              | Audi AG, 85057 INGOLSTADT, Tyskland |

**Design 1**

|      |                            |  |
|------|----------------------------|--|
| (54) | <b>Produkt:</b>            | Scale model car  |
| (51) | <b>Klasse:</b>             | 21-01  |
| (72) | <b>Designer:</b>           | Jakob Hirzel, c/o AUDI AG, 85045 INGOLSTADT, Tyskland (DE)<br>Andreas Krüger, c/o AUDI AG, 85045 INGOLSTADT, Tyskland (DE) |
| (30) | <b>Prioritet:</b>          | 2019.06.11, EM, 006575585, 1   |
| (55) | <b>Designavbildninger:</b> |  |



1.1



1.2



1.3





1.4



1.5



1.6



1.7

---

|      |                                |                                     |
|------|--------------------------------|-------------------------------------|
| (11) | <b>Reg.nr.:</b>                | <b>DM/202156</b>                    |
| (21) | <b>Søkn.nr.:</b>               | 20191065                            |
| (22) | <b>Inngitt i WIPO:</b>         | 2019.07.10                          |
| (15) | <b>Registrert i WIPO:</b>      | 2019.07.10                          |
| (24) | <b>Løpedag:</b>                | 2019.07.10                          |
| (43) | <b>Allm. tilgj.:</b>           | 2019.08.09                          |
| (15) | <b>Besluttet gjeldende NO:</b> | 2019.08.16                          |
| (45) | <b>Kunngjort NO:</b>           | 2019.09.09                          |
| (18) | <b>Reg. gjelder til:</b>       | 2024.07.10                          |
| (73) | <b>Innehaver:</b>              | Audi AG, 85057 INGOLSTADT, Tyskland |

**Design 1**

|      |                            |  |
|------|----------------------------|--|
| (54) | <b>Produkt:</b>            | Vehicle wheel rim  |
| (51) | <b>Klasse:</b>             | 12-16  |
| (72) | <b>Designer:</b>           | Tünde Daniel, c/o AUDI AG, 85045 INGOLSTADT, Tyskland (DE) |
| (30) | <b>Prioritet:</b>          | 2019.06.04, EM, 006565693, 1                               |
| (55) | <b>Designavbildninger:</b> |  |



1.1



1.2



1.3



1.4



1.5



1.6



1.7

|      |                                |                                     |
|------|--------------------------------|-------------------------------------|
| (11) | <b>Reg.nr.:</b>                | <b>DM/202164</b>                    |
| (21) | <b>Søkn.nr.:</b>               | 20191066                            |
| (22) | <b>Inngitt i WIPO:</b>         | 2019.07.11                          |
| (15) | <b>Registrert i WIPO:</b>      | 2019.07.11                          |
| (24) | <b>Løpedag:</b>                | 2019.07.11                          |
| (43) | <b>Allm. tilgj.:</b>           | 2019.08.09                          |
| (15) | <b>Besluttet gjeldende NO:</b> | 2019.08.16                          |
| (45) | <b>Kunngjort NO:</b>           | 2019.09.09                          |
| (18) | <b>Reg. gjelder til:</b>       | 2024.07.11                          |
| (73) | <b>Innehaver:</b>              | Audi AG, 85057 INGOLSTADT, Tyskland |

**Design 1**

|      |                            |   |
|------|----------------------------|---|
| (54) | <b>Produkt:</b>            | Vehicle wheel rim   |
| (51) | <b>Klasse:</b>             | 12-16   |
| (72) | <b>Designer:</b>           | Andreas Valencia Pollex, c/o AUDI AG, 85045 INGOLSTADT, Tyskland (DE) |
| (30) | <b>Prioritet:</b>          | 2019.06.11, EM, 006575593, 1, 2, 3, 4                                 |
| (55) | <b>Designavbildninger:</b> |   |



1.1



1.2



1.3



1.4



1.5



1.6



1.7

**Design 2**

(54) **Produkt:** Vehicle wheel rim  
(51) **Klasse:** 12-16  
(72) **Designer:** Andreas Valencia Pollex, c/o AUDI AG, 85045 INGOLSTADT, Tyskland (DE)  
(30) **Prioritet:** 2019.06.11, EM, 006575593, 1, 2, 3, 4  
(55) **Designavbildninger:**



2.1



2.2



2.3



2.4



2.5



2.6



2.7

**Design 3**

(54) **Produkt:** Vehicle wheel rim  
(51) **Klasse:** 12-16  
(72) **Designer:** Tünde Daniel, c/o AUDI AG, 85045 INGOLSTADT, Tyskland (DE)  
(30) **Prioritet:** 2019.06.11, EM, 006575593, 1, 2, 3, 4  
(55) **Designavbildninger:**



3.1



3.2



3.3



3.4



3.5



3.6



3.7

**Design 4**

(54) **Produkt:** Vehicle wheel rim  
(51) **Klasse:** 12-16  
(72) **Designer:** Tünde Daniel, c/o AUDI AG, 85045 INGOLSTADT, Tyskland (DE)  
(30) **Prioritet:** 2019.06.11, EM, 006575593, 1, 2, 3, 4  
(55) **Designavbildninger:**



4.1



4.2



4.3



4.4



4.5



4.6



4.7

|      |                                |   |
|------|--------------------------------|---|
| (11) | <b>Reg.nr.:</b>                | <b>DM/202178</b>  |
| (21) | <b>Søkn.nr.:</b>               | 20191067  |
| (22) | <b>Inngitt i WIPO:</b>         | 2019.07.09  |
| (15) | <b>Registrert i WIPO:</b>      | 2019.07.09  |
| (24) | <b>Løpedag:</b>                | 2019.07.09  |
| (43) | <b>Allm. tilgj.:</b>           | 2019.08.09  |
| (15) | <b>Besluttet gjeldende NO:</b> | 2019.08.16  |
| (45) | <b>Kunngjort NO:</b>           | 2019.09.09  |
| (18) | <b>Reg. gjelder til:</b>       | 2024.07.09  |
| (73) | <b>Innehaver:</b>              | Vaillant GmbH, Berghauser Strasse 40, 42859 REMSCHEID, Tyskland |

**Design 1**

|      |                            |  |
|------|----------------------------|--|
| (54) | <b>Produkt:</b>            | Remote control unit  |
| (51) | <b>Klasse:</b>             | 14-03  |
| (72) | <b>Designer:</b>           | Tim Richter, c/o Vaillant GmbH Berghauser Strasse 40, 42859 REMSCHEID, Tyskland (DE) |
| (30) | <b>Prioritet:</b>          | 2019.02.27, EM, 006269189, 1   |
| (55) | <b>Designavbildninger:</b> |  |

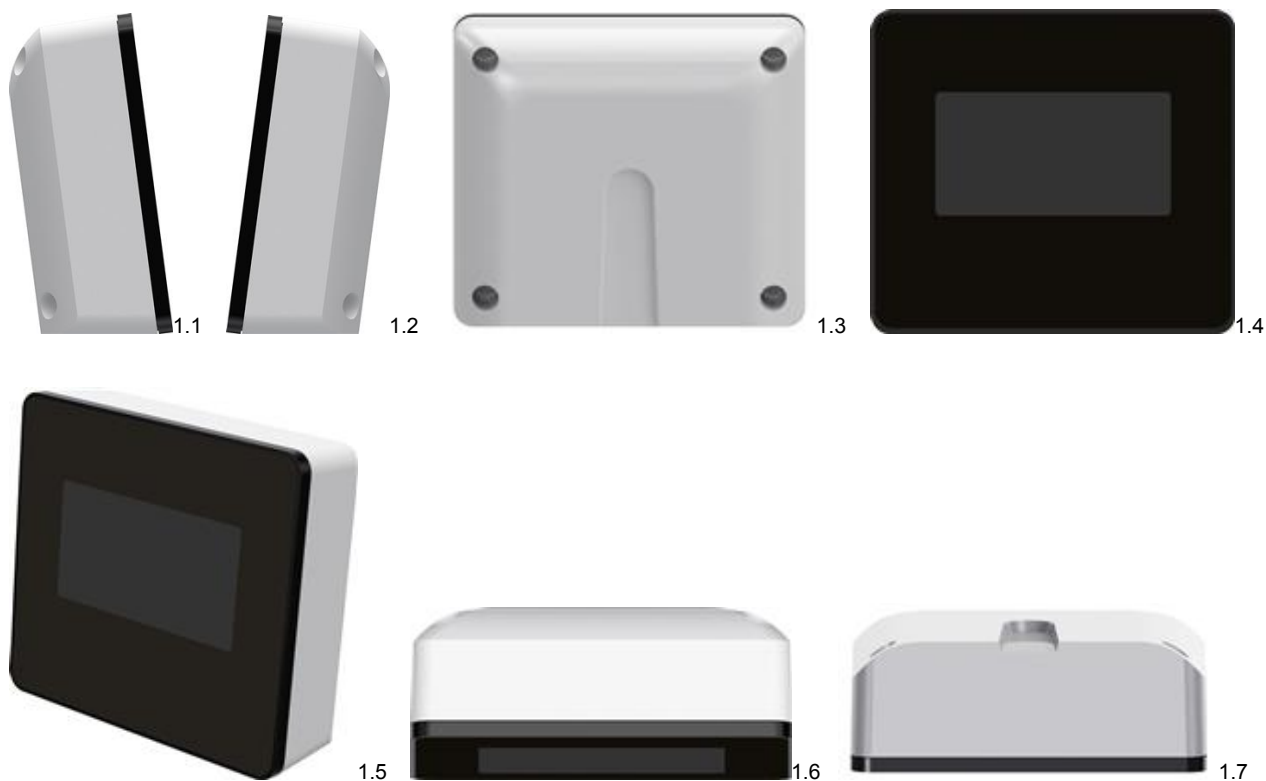



|      |                                |   |
|------|--------------------------------|---|
| (11) | <b>Reg.nr.:</b>                | <b>DM/202180</b>  |
| (21) | <b>Søkn.nr.:</b>               | 20191068  |
| (22) | <b>Inngitt i WIPO:</b>         | 2019.07.02  |
| (15) | <b>Registrert i WIPO:</b>      | 2019.07.02  |
| (24) | <b>Løpedag:</b>                | 2019.07.02  |
| (43) | <b>Allm. tilgj.:</b>           | 2019.08.09  |
| (15) | <b>Besluttet gjeldende NO:</b> | 2019.08.16  |
| (45) | <b>Kunngjort NO:</b>           | 2019.09.09  |
| (18) | <b>Reg. gjelder til:</b>       | 2024.07.02  |
| (73) | <b>Innehaver:</b>              | Xindao B.V., Verrijn Stuartlaan 1 d, 2288EK RIJSWIJK, Nederland |
| (50) | <b>Anmerkninger:</b>           | Registreringen gjelder samregistrering.                         |

**Design 1**

|      |                            |   |
|------|----------------------------|---|
| (54) | <b>Produkt:</b>            | Backpack  |
| (51) | <b>Klasse:</b>             | 03-01   |
| (72) | <b>Designer:</b>           | Feifei Tang, Rm. 603, No. 47, Lane 68, Qing Jian Rd. SHANGHAI,, Kina (CN) |
| (30) | <b>Prioritet:</b>          | 2019.06.27, IL, 63861, 1  |
| (55) | <b>Designavbildninger:</b> |   |

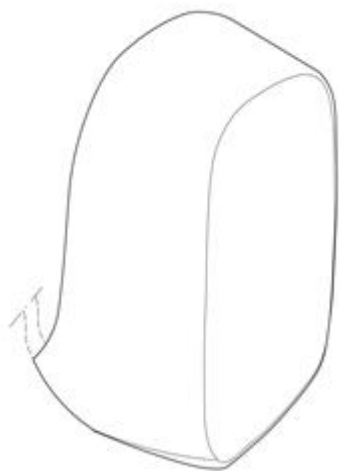

1.1

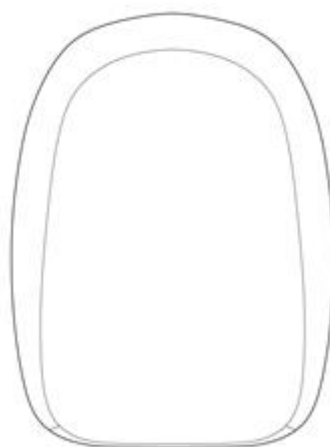

1.2

**Design 2**

|      |                            |   |
|------|----------------------------|---|
| (54) | <b>Produkt:</b>            | Backpack  |
| (51) | <b>Klasse:</b>             | 03-01   |
| (72) | <b>Designer:</b>           | Feifei Tang, Rm. 603, No. 47, Lane 68, Qing Jian Rd. SHANGHAI,, Kina (CN) |
| (55) | <b>Designavbildninger:</b> |   |



2.1



2.2

|      |                                |  |
|------|--------------------------------|--|
| (11) | <b>Reg.nr.:</b>                | <b>DM/202182</b>   |
| (21) | <b>Søkn.nr.:</b>               | 20191069   |
| (22) | <b>Inngitt i WIPO:</b>         | 2019.07.12   |
| (15) | <b>Registrert i WIPO:</b>      | 2019.07.12   |
| (24) | <b>Løpedag:</b>                | 2019.07.12   |
| (43) | <b>Allm. tilgj.:</b>           | 2019.08.09   |
| (15) | <b>Besluttet gjeldende NO:</b> | 2019.08.16   |
| (45) | <b>Kunngjort NO:</b>           | 2019.09.09   |
| (18) | <b>Reg. gjelder til:</b>       | 2024.07.12   |
| (73) | <b>Innehaver:</b>              | Bugatti International S.A., 412F route d'Esch, 1030 LUXEMBOURG, Luxembourg |
| (50) | <b>Anmerkninger:</b>           | Registreringen gjelder samregistrering.                                    |

**Design 1**

|      |                            |   |
|------|----------------------------|---|
| (54) | <b>Produkt:</b>            | Automobile                                      |
| (51) | <b>Klasse:</b>             | 12-08<br>12-16                                  |
| (72) | <b>Designer:</b>           |   |
| (30) | <b>Prioritet:</b>          | 2019.03.04, EM, 6276655, 1, 2, 3, 4, 5, 6, 7, 8 |
| (55) | <b>Designavbildninger:</b> |   |



1.1



1.2



1.3

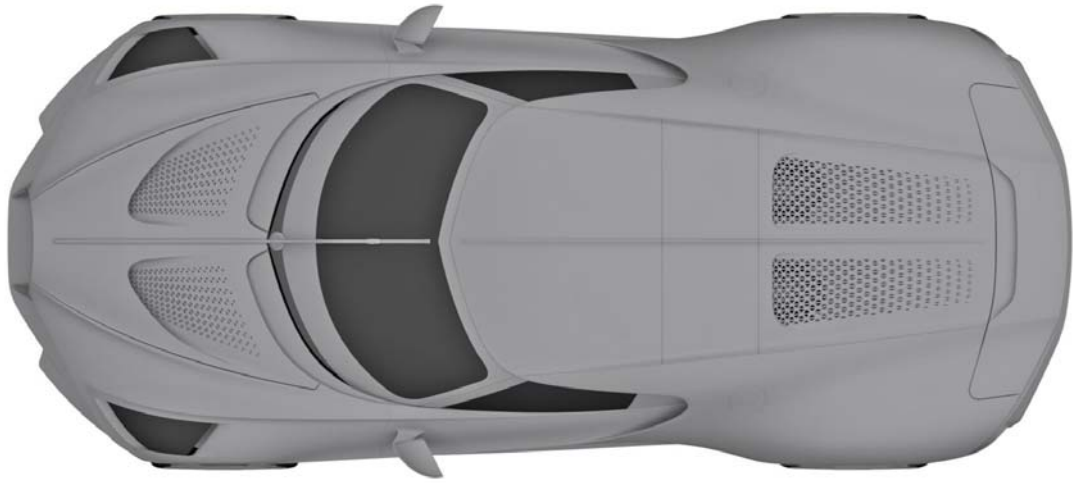

1.4



1.5



1.6

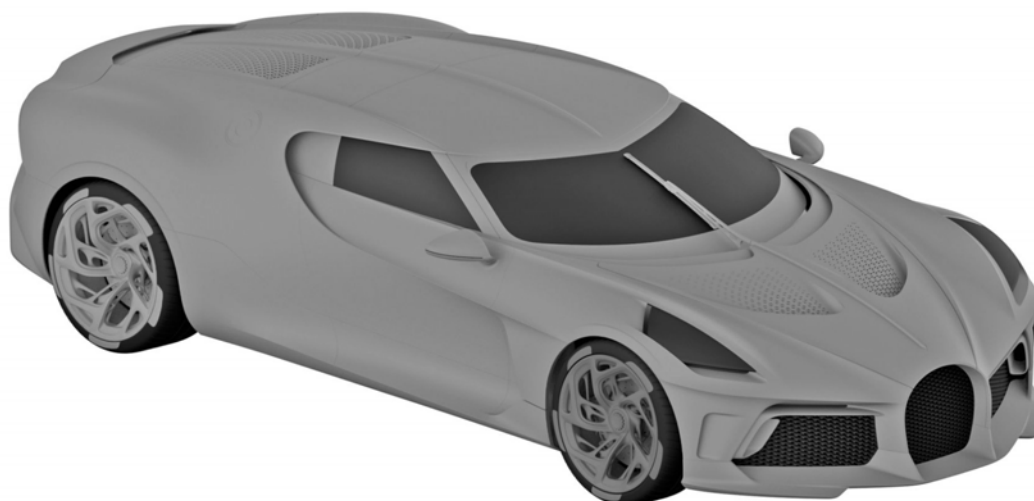

1.7

**Design 2**

(54) **Produkt:** Automobile  
(51) **Klasse:** 12-08  
12-16  
(72) **Designer:**  
(30) **Prioritet:** 2019.03.04, EM, 6276655, 1, 2, 3, 4, 5, 6, 7, 8  
(55) **Designavbildninger:**



2.1

**Design 3**

- (54) **Produkt:** Automobile  
(51) **Klasse:** 12-08  
12-16  
(72) **Designer:**  
(30) **Prioritet:** 2019.03.04, EM, 6276655, 1, 2, 3, 4, 5, 6, 7, 8  
(55) **Designavbildninger:**



3.1

**Design 4**

- (54) **Produkt:** Automobile  
(51) **Klasse:** 12-08  
12-16  
(72) **Designer:**  
(30) **Prioritet:** 2019.03.04, EM, 6276655, 1, 2, 3, 4, 5, 6, 7, 8  
(55) **Designavbildninger:**



4.1

**Design 5**

(54) **Produkt:** Automobile  
(51) **Klasse:** 12-08  
12-16  
(72) **Designer:**  
(30) **Prioritet:** 2019.03.04, EM, 6276655, 1, 2, 3, 4, 5, 6, 7, 8  
(55) **Designavbildninger:**

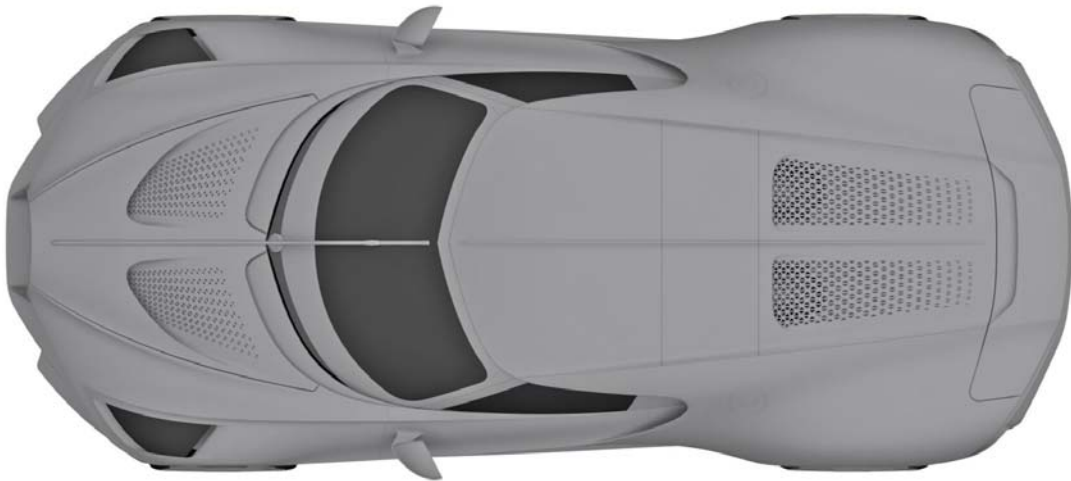

5.1

**Design 6**

(54) **Produkt:** Rim for vehicle wheels  
(51) **Klasse:** 12-08  
12-16  
(72) **Designer:**  
(30) **Prioritet:** 2019.03.04, EM, 6276655, 1, 2, 3, 4, 5, 6, 7, 8  
(55) **Designavbildninger:**



6.1



6.2



6.3



6.4

**Design 7**

(54) **Produkt:** Bonnet for vehicles  
 (51) **Klasse:** 12-08  
 12-16  
 (72) **Designer:**  
 (30) **Prioritet:** 2019.03.04, EM, 6276655, 1, 2, 3, 4, 5, 6, 7, 8  
 (55) **Designavbildninger:**

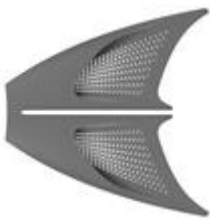

7.1



7.2



7.3



7.4

**Design 8**

(54) **Produkt:** Windscreen for vehicles  
 (51) **Klasse:** 12-08  
 12-16  
 (72) **Designer:**  
 (30) **Prioritet:** 2019.03.04, EM, 6276655, 1, 2, 3, 4, 5, 6, 7, 8  
 (55) **Designavbildninger:**



8.1



8.2



8.3



8.4

|      |                                |   |
|------|--------------------------------|---|
| (11) | <b>Reg.nr.:</b>                | <b>DM/202187</b>  |
| (21) | <b>Søkn.nr.:</b>               | 20191070  |
| (22) | <b>Inngitt i WIPO:</b>         | 2018.12.20  |
| (15) | <b>Registrert i WIPO:</b>      | 2018.12.20  |
| (24) | <b>Løpedag:</b>                | 2018.12.20  |
| (43) | <b>Allm. tilgj.:</b>           | 2019.08.09  |
| (15) | <b>Besluttet gjeldende NO:</b> | 2019.08.16  |
| (45) | <b>Kunngjort NO:</b>           | 2019.09.09  |
| (18) | <b>Reg. gjelder til:</b>       | 2023.12.20  |
| (73) | <b>Innehaver:</b>              | Stephen Patrick Wood, 201 Edgewood Drive, 96145 TAHOE CITY, USA |

**Design 1**

|      |                            |   |
|------|----------------------------|---|
| (54) | <b>Produkt:</b>            | Snow and ice removal paddle   |
| (51) | <b>Klasse:</b>             | 08-05   |
| (72) | <b>Designer:</b>           | Lorraine Wood, 201 Edgewood Drive, 96145 TAHOE CITY, USA (US)<br>Stephen Wood, 201 Edgewood Drive, 96145 TAHOE CITY, USA (US) |
| (30) | <b>Prioritet:</b>          | 2018.06.21, US, 29/654,189, 1   |
| (55) | <b>Designavbildninger:</b> |   |

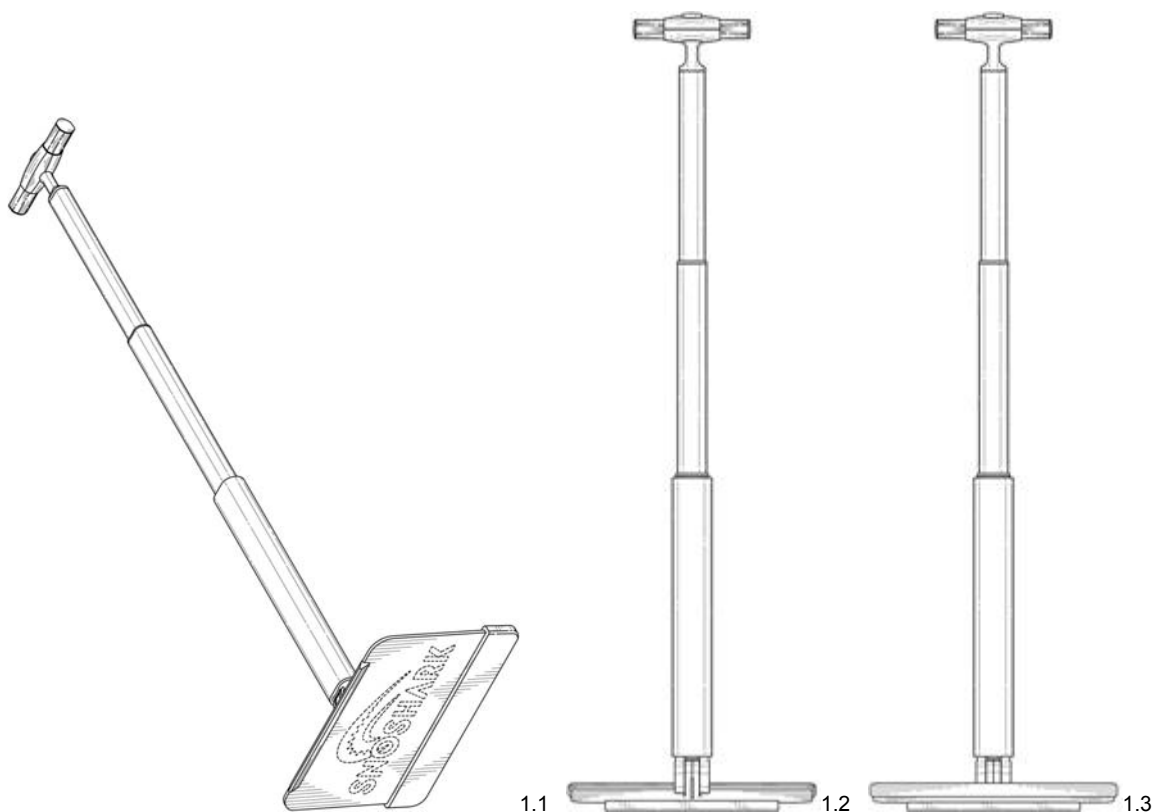



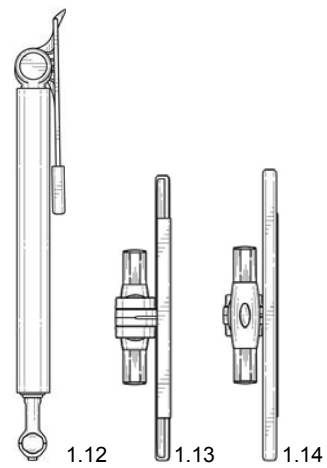
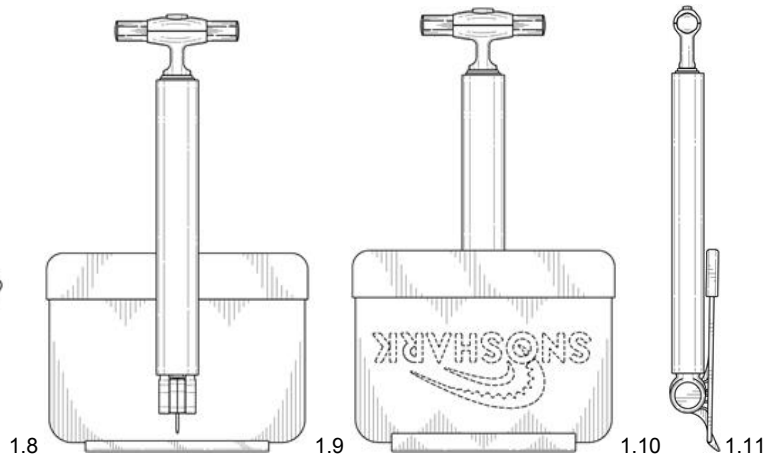
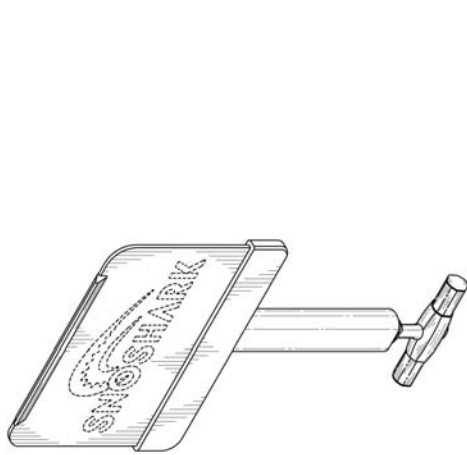
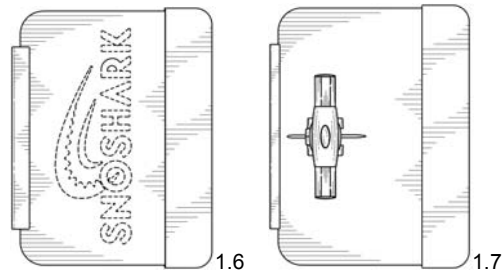
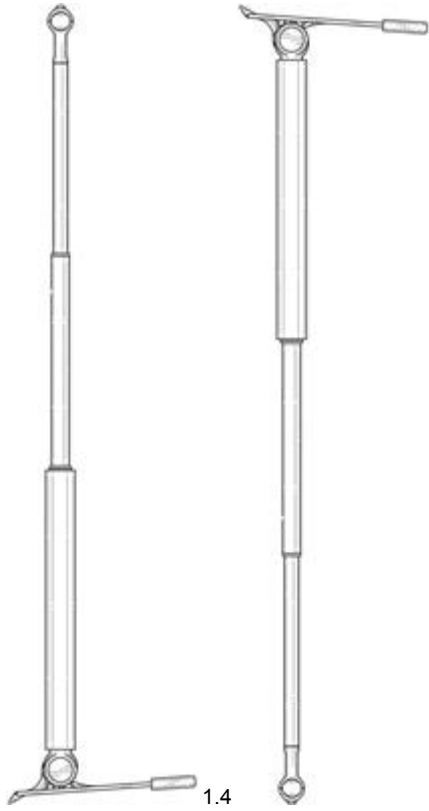

|                                     |   |
|-------------------------------------|---|
| (11) <b>Reg.nr.:</b>                | <b>DM/202188</b>  |
| (21) <b>Søkn.nr.:</b>               | 20191071  |
| (22) <b>Inngitt i WIPO:</b>         | 2019.02.07  |
| (15) <b>Registrert i WIPO:</b>      | 2019.02.07  |
| (24) <b>Løpedag:</b>                | 2019.02.07  |
| (43) <b>Allm. tilgj.:</b>           | 2019.08.09  |
| (15) <b>Besluttet gjeldende NO:</b> | 2019.08.16  |
| (45) <b>Kunngjort NO:</b>           | 2019.09.09  |
| (18) <b>Reg. gjelder til:</b>       | 2024.02.07  |
| (73) <b>Innehaver:</b>              | SAFETY SEAL EUROPE AB, Plogvägen 3, 46730 GRÄSTORP, Sverige |
| (50) <b>Anmerkninger:</b>           | Registreringen gjelder samregistrering.                     |

**Design 1**

|                                 |   |
|---------------------------------|---|
| (54) <b>Produkt:</b>            | Wheel-nut locking device  |
| (51) <b>Klasse:</b>             | 08-07   |
| (72) <b>Designer:</b>           | Bengt-Åke Nilsson, Hyringa Skrehalla 1, 467 95 GRÄSTORP, Sverige (SE) |
| (55) <b>Designavbildninger:</b> |   |

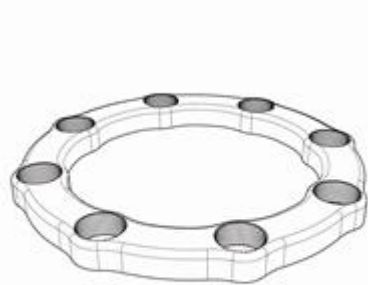

1.1

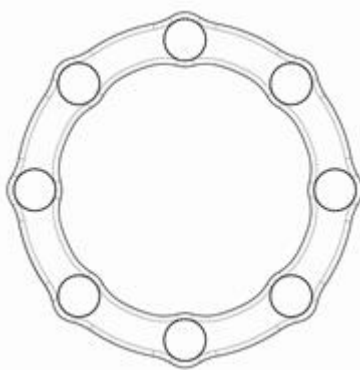

1.2



1.3



1.4



1.5



1.6

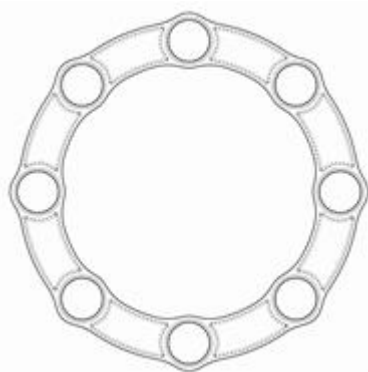

1.7

**Design 2**

- (54) **Produkt:** Wheel-nut locking device
- (51) **Klasse:** 08-07
- (72) **Designer:** Bengt-Åke Nilsson, Hyringa Skrehalla 1, 467 95 GRÄSTORP, Sverige (SE)
- (55) **Designavbildninger:**

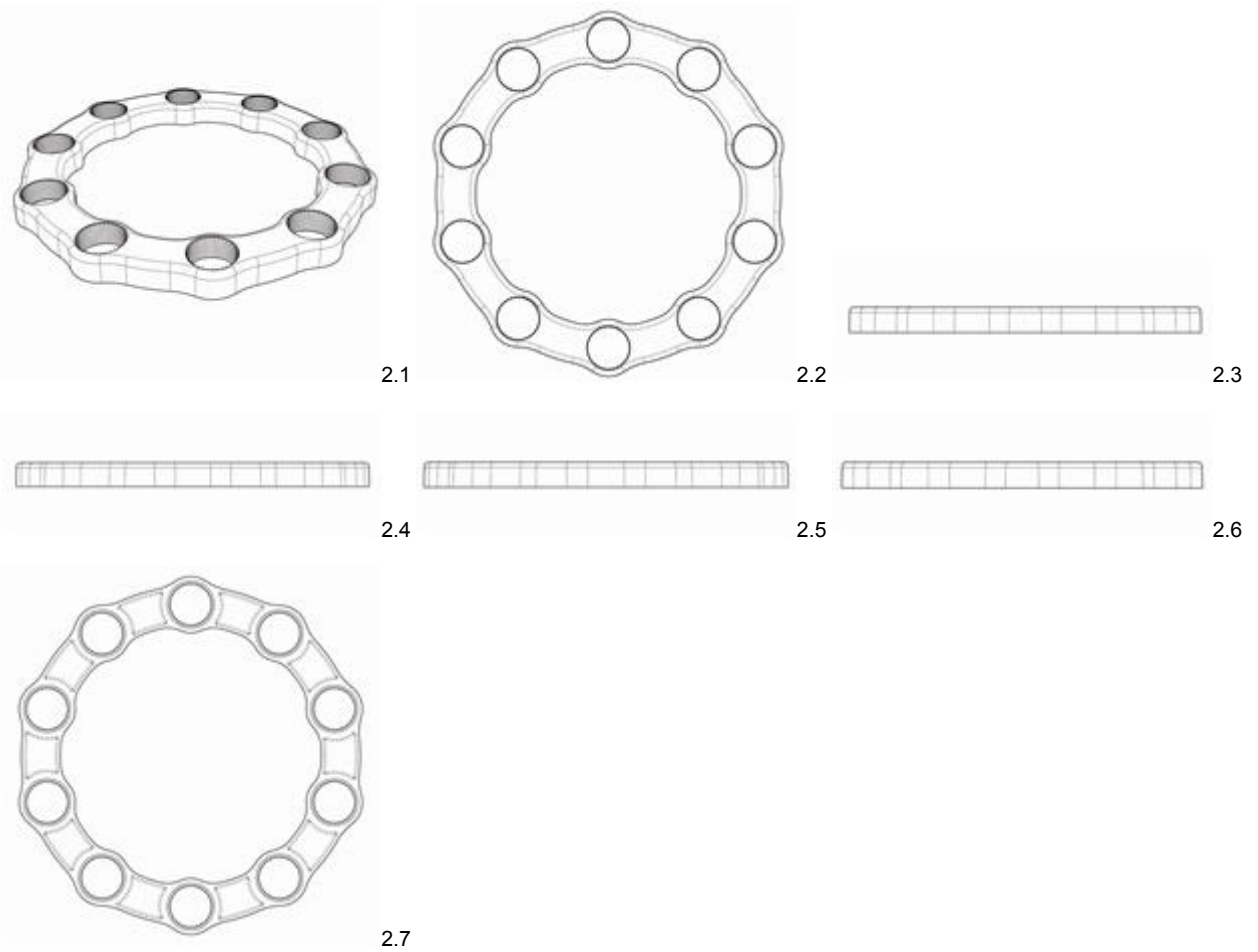

**Design 3**

- (54) **Produkt:** Wheel-nut locking device
- (51) **Klasse:** 08-07
- (72) **Designer:** Bengt-Åke Nilsson, Hyringa Skrehalla 1, 467 95 GRÄSTORP, Sverige (SE)
- (55) **Designavbildninger:**

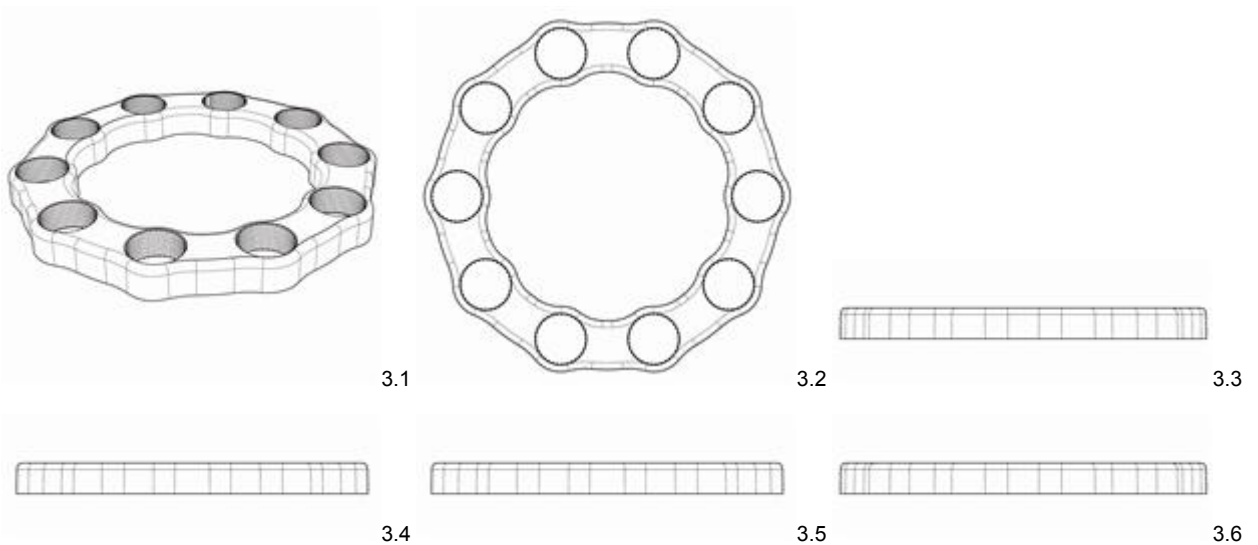

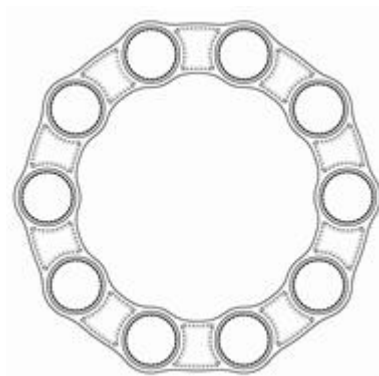

3.7

**Design 4**

(54) **Produkt:** Wheel-nut locking device  
 (51) **Klasse:** 08-07  
 (72) **Designer:** Bengt-Åke Nilsson, Hyringa Skrehalla 1, 467 95 GRÅSTORP, Sverige (SE)  
 (55) **Designavbildninger:**

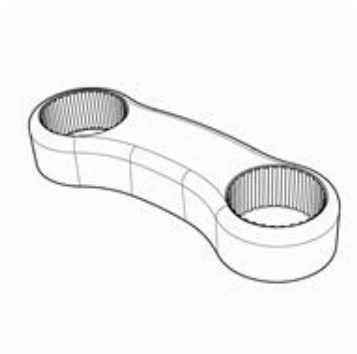

4.1



4.2



4.3

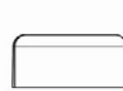

4.4



4.5



4.6

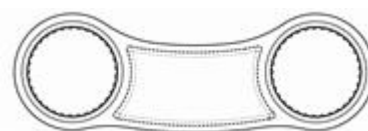

4.7

|      |                                |  |
|------|--------------------------------|--|
| (11) | <b>Reg.nr.:</b>                | <b>DM/202214</b>   |
| (21) | <b>Søkn.nr.:</b>               | 20191082   |
| (22) | <b>Inngitt i WIPO:</b>         | 2018.09.25   |
| (15) | <b>Registrert i WIPO:</b>      | 2018.09.25   |
| (24) | <b>Løpedag:</b>                | 2018.09.25   |
| (43) | <b>Allm. tilgj.:</b>           | 2019.08.16   |
| (15) | <b>Besluttet gjeldende NO:</b> | 2019.08.19   |
| (45) | <b>Kunngjort NO:</b>           | 2019.09.09   |
| (18) | <b>Reg. gjelder til:</b>       | 2023.09.25   |
| (73) | <b>Innehaver:</b>              | Sam David Joseph Collier, The Beeches, Perivale Lane, UB6 8TW GREENFORD, Storbritannia |
| (50) | <b>Anmerkninger:</b>           | Registreringen gjelder samregistrering.  |

**Design 1**

|      |                            |   |
|------|----------------------------|---|
| (54) | <b>Produkt:</b>            | Part of a case for mobile telephones  |
| (51) | <b>Klasse:</b>             | 03-01   |
| (72) | <b>Designer:</b>           | Sam David Joseph Collier, The Beeches, Perivale Lane, UB6 8TW GREENFORD, Storbritannia (GB) |
| (30) | <b>Prioritet:</b>          | 2018.03.26, GB, 6031680, 1  |
| (55) | <b>Designavbildninger:</b> |   |

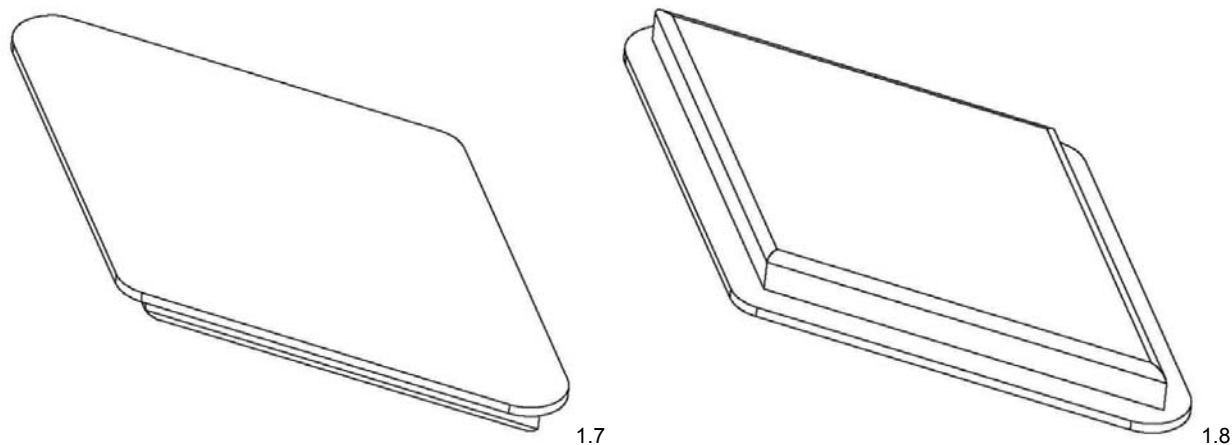
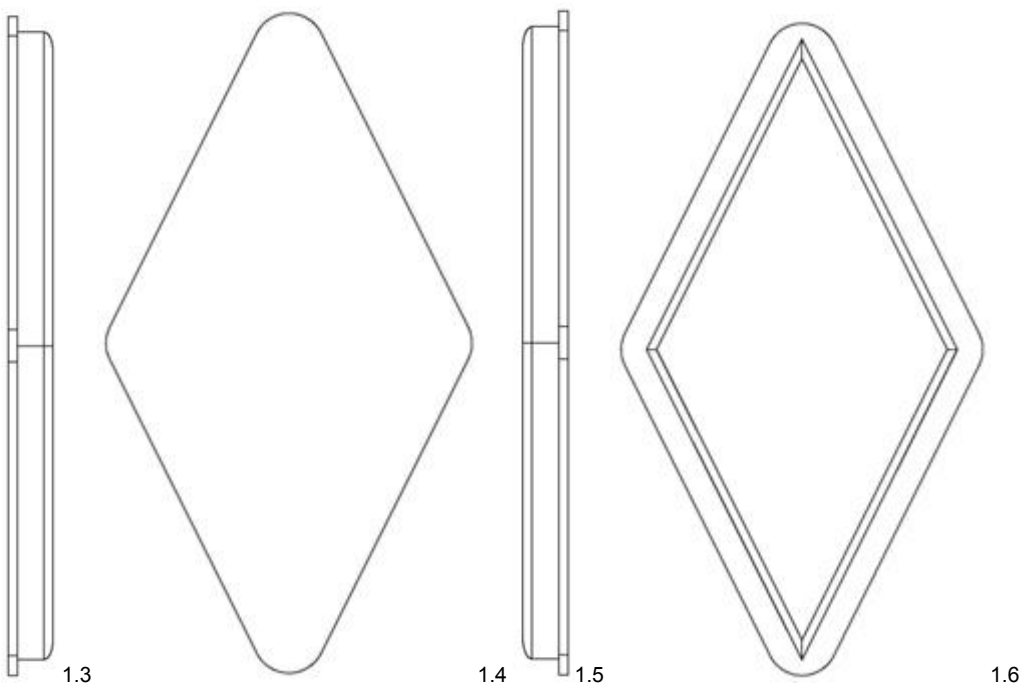
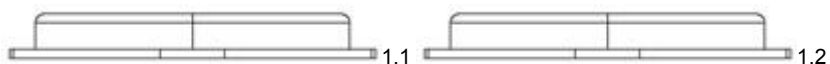

**Design 2**

- (54) **Produkt:** Part of a case for mobile telephones  
(51) **Klasse:** 03-01  
(72) **Designer:** Sam David Joseph Collier, The Beeches, Perivale Lane, UB6 8TW GREENFORD, Storbritannia (GB)  
(30) **Prioritet:** 2018.03.26, GB, 6031670, 2  
(55) **Designavbildninger:**

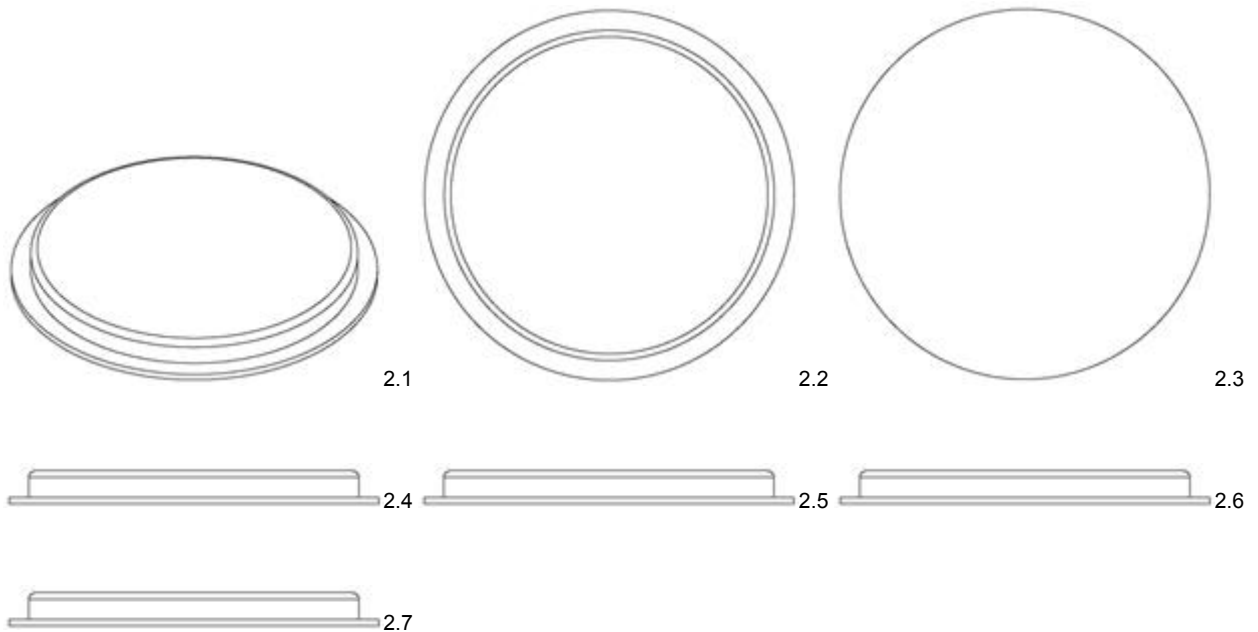
**Design 3**

- (54) **Produkt:** Case for mobile telephones  
(51) **Klasse:** 03-01  
(72) **Designer:** Sam David Joseph Collier, The Beeches, Perivale Lane, UB6 8TW GREENFORD, Storbritannia (GB)  
(30) **Prioritet:** 2018.03.26, GB, 6031681, 3  
(55) **Designavbildninger:**

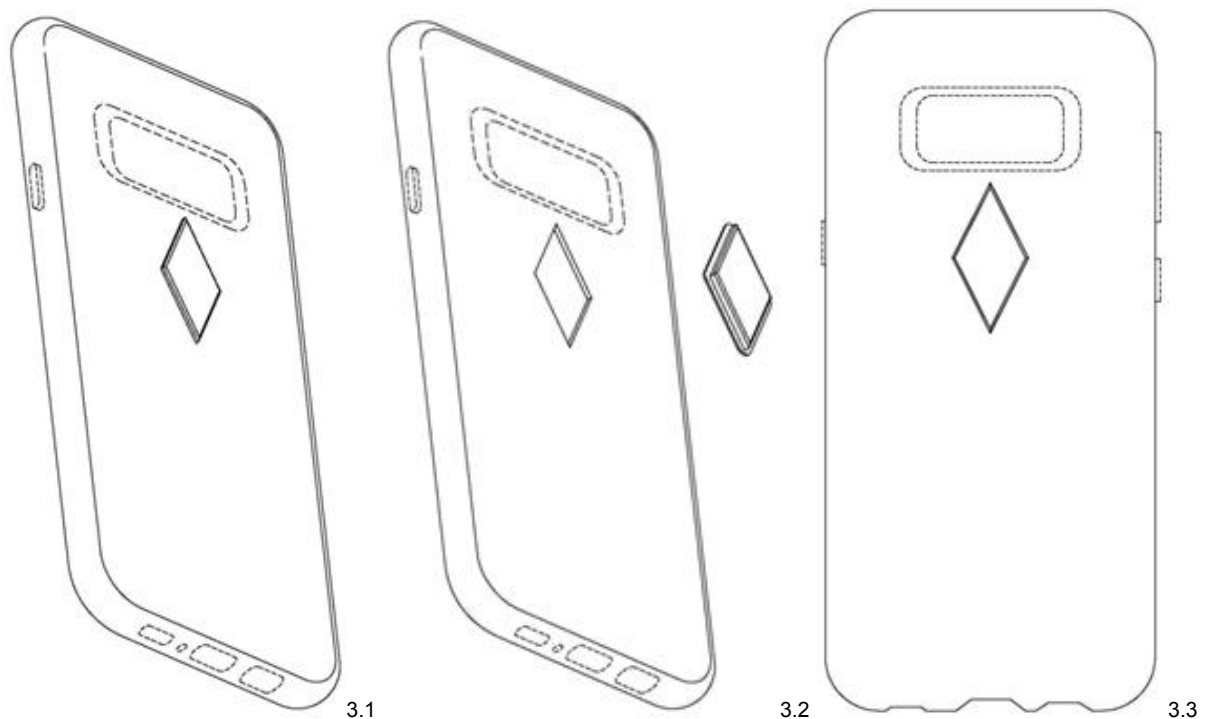

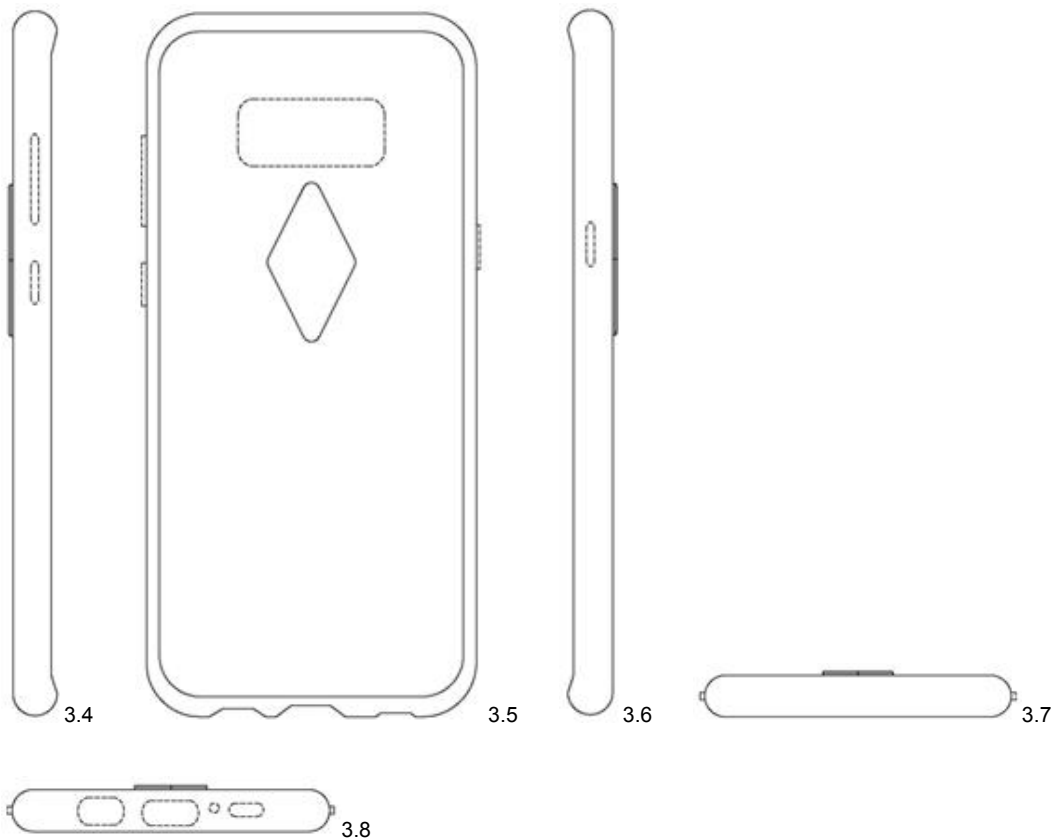

**Design 4**

- (54) **Produkt:** Case for mobile telephones
- (51) **Klasse:** 03-01
- (72) **Designer:** Sam David Joseph Collier, The Beeches, Perivale Lane, UB6 8TW GREENFORD, Storbritannia (GB)
- (30) **Prioritet:** 2018.03.26, GB, 6031678, 4
- (55) **Designavbildninger:**

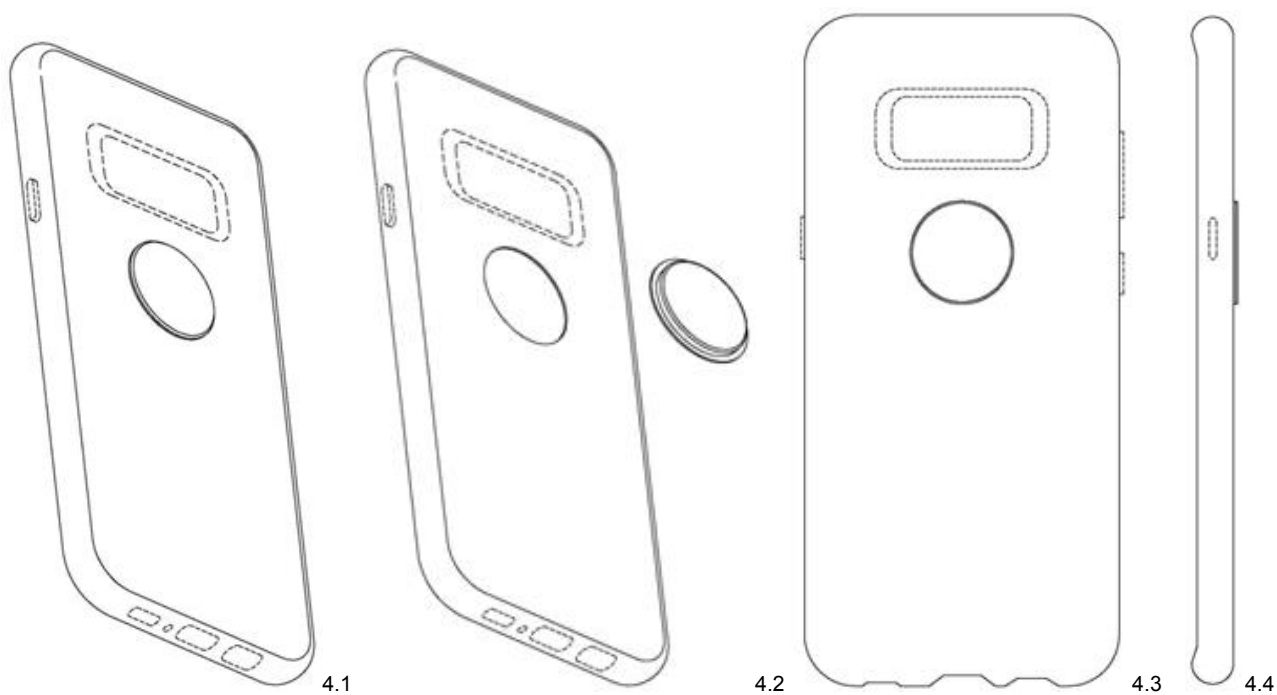

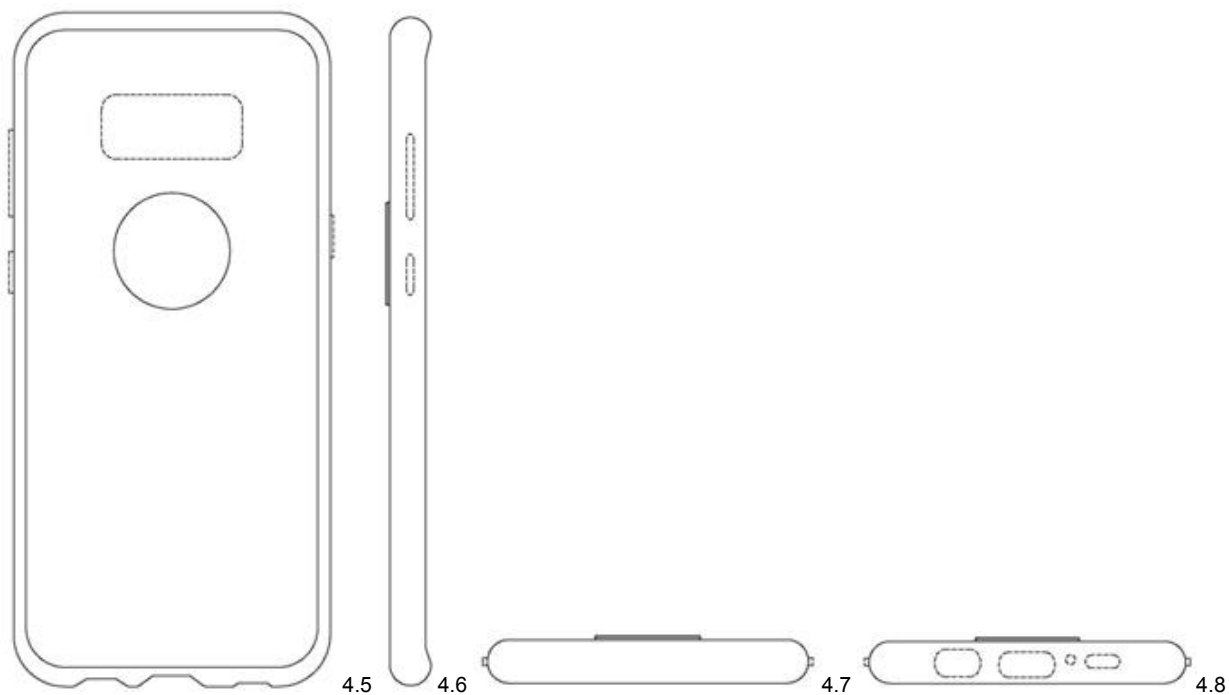



|      |                                |   |
|------|--------------------------------|---|
| (11) | <b>Reg.nr.:</b>                | <b>DM/202224</b>  |
| (21) | <b>Søkn.nr.:</b>               | 20191083  |
| (22) | <b>Inngitt i WIPO:</b>         | 2018.07.10  |
| (15) | <b>Registrert i WIPO:</b>      | 2018.07.10  |
| (24) | <b>Løpedag:</b>                | 2018.07.10  |
| (43) | <b>Allm. tilgj.:</b>           | 2019.08.16  |
| (15) | <b>Besluttet gjeldende NO:</b> | 2019.08.21  |
| (45) | <b>Kunngjort NO:</b>           | 2019.09.09  |
| (18) | <b>Reg. gjelder til:</b>       | 2023.07.10  |
| (73) | <b>Innehaver:</b>              | CURT G. JOA, INC., 100 Crocker Avenue, WI53085 SHEBOYGAN FALLS, USA |
| (50) | <b>Anmerkninger:</b>           | Registreringen gjelder samregistrering.                             |

**Design 1**

|      |                            |  |
|------|----------------------------|--|
| (54) | <b>Produkt:</b>            | Stretch laminate   |
| (51) | <b>Klasse:</b>             | 05-06  |
| (72) | <b>Designer:</b>           | Michael Schaap, 2828 Rammer Court, WI53081 SHEBOYGAN, USA (US) |
| (30) | <b>Prioritet:</b>          | 2018.03.29, US, 29/642,479, 1                                  |
| (55) | <b>Designavbildninger:</b> |  |

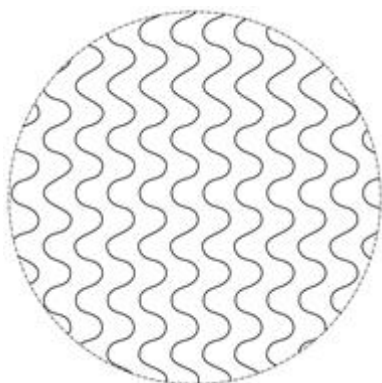
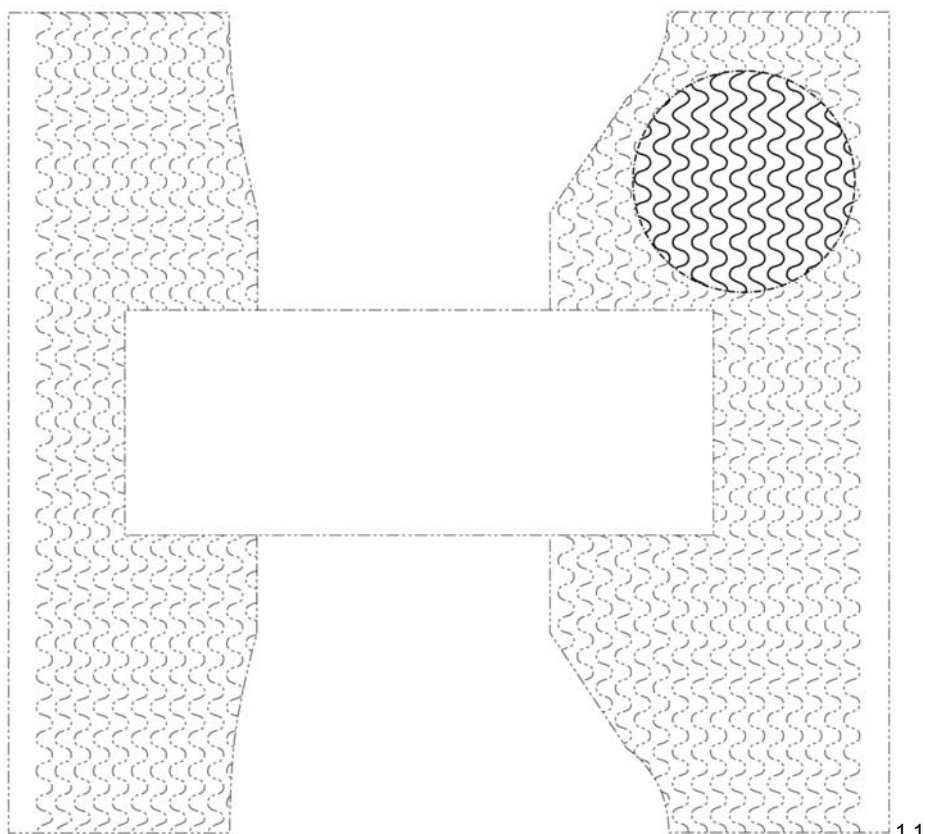

**Design 2**

(54) **Produkt:** Stretch laminate  
(51) **Klasse:** 05-06  
(72) **Designer:** Michael Schaap, 2828 Rammer Court, WI53081 SHEBOYGAN, USA (US)  
(30) **Prioritet:** 2018.03.29, US, 29/642,481, 2  
(55) **Designavbildninger:**

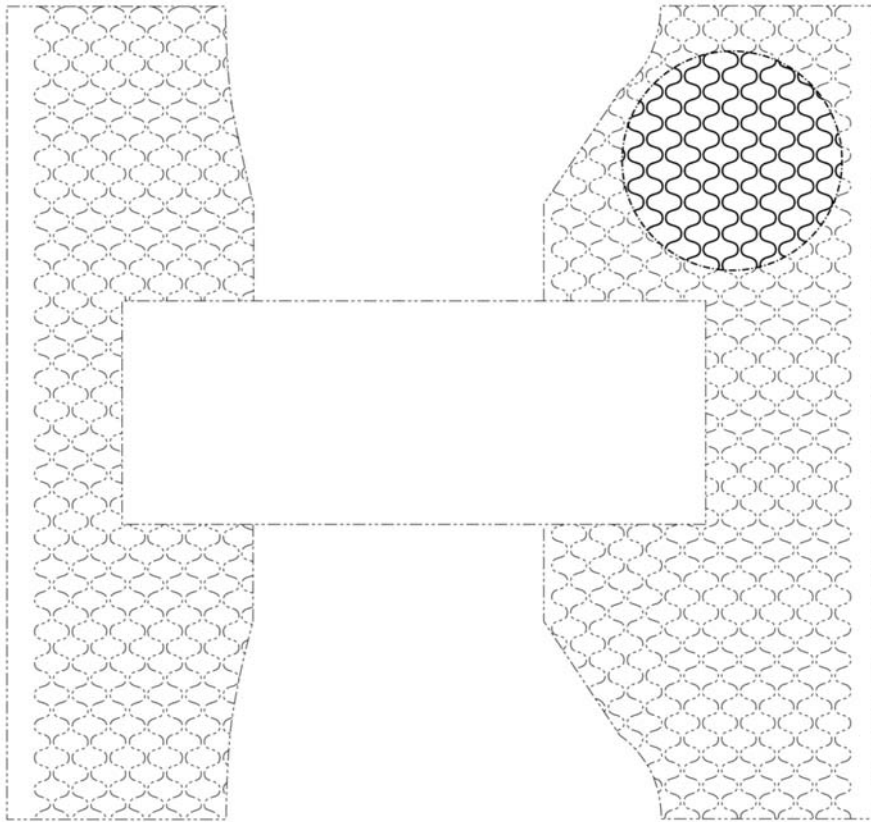

2.1

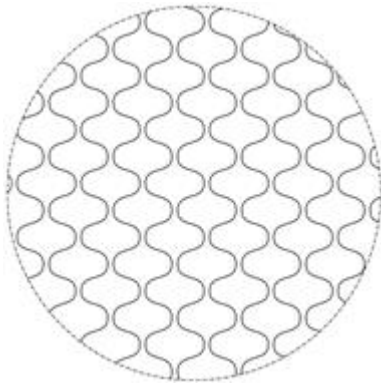

2.2

|                              |   |
|------------------------------|---|
| (11) Reg.nr.:                | DM/202227   |
| (21) Søkn.nr.:               | 20191084  |
| (22) Inngitt i WIPO:         | 2018.10.10  |
| (15) Registrert i WIPO:      | 2018.10.10  |
| (24) Løpedag:                | 2018.10.10  |
| (43) Allm. tilgj.:           | 2019.08.16  |
| (15) Besluttet gjeldende NO: | 2019.08.21  |
| (45) Kunngjort NO:           | 2019.09.09  |
| (18) Reg. gjelder til:       | 2023.10.10  |
| (73) Innehaver:              | Asgeir Moripen, Kristian Bognerudsvei 14A, 0956 OSLO, Norge |
| (50) Anmerkninger:           | Registreringen gjelder samregistrering.                     |

**Design 1**

|                          |                                       |
|--------------------------|---------------------------------------|
| (54) Produkt:            | Pouch for mobile telephones           |
| (51) Klasse:             | 03-01                                 |
| (72) Designer:           | EYEPOC AS, Tvetenveien 30B, 0666 OSLO |
| (30) Prioritet:          | 2019.06.28, NO, 201808577, 1, 2       |
| (55) Designavbildninger: |                                       |

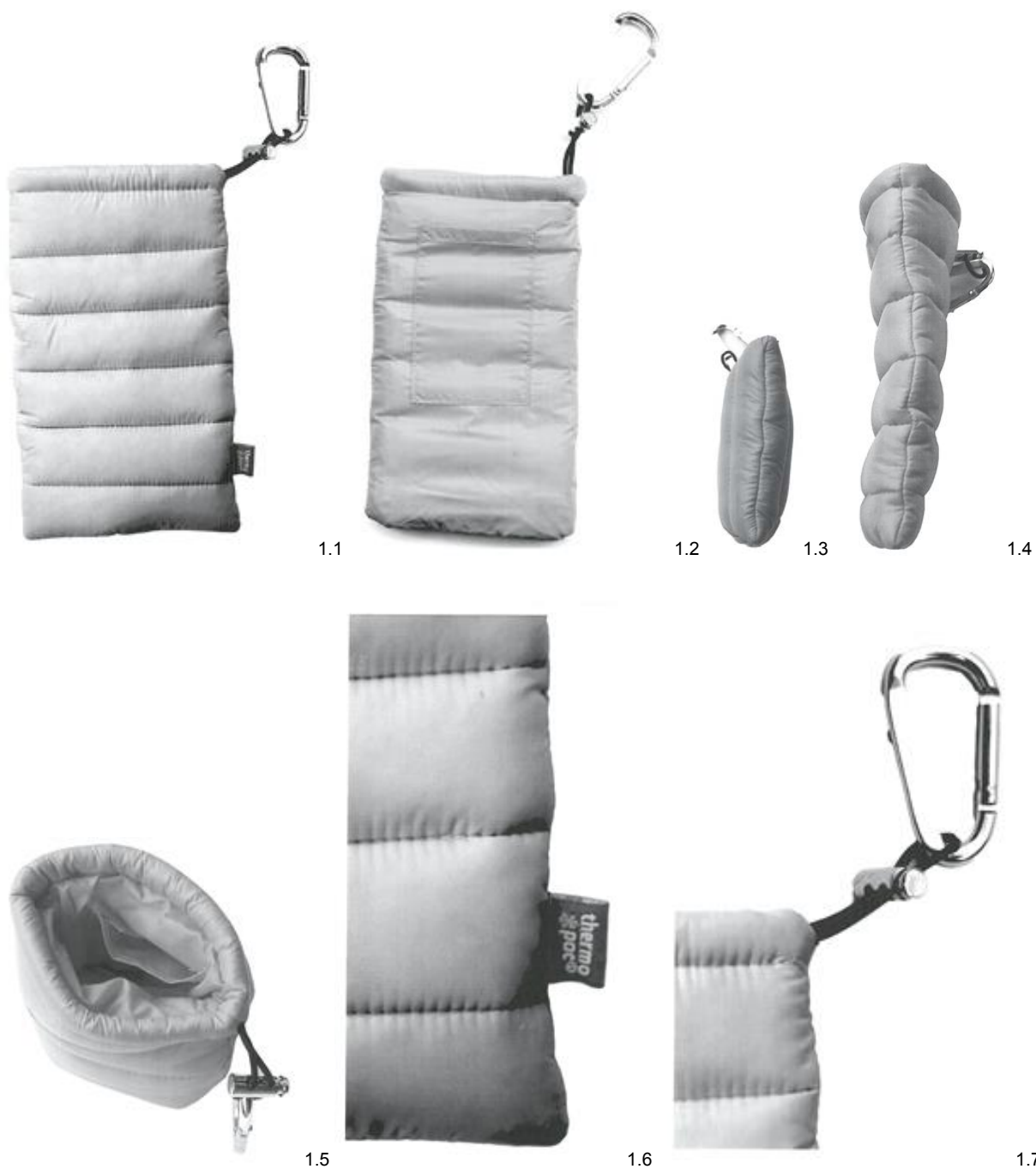

**Design 2**

- (54) **Produkt:** Pouch for mobile telephones  
(51) **Klasse:** 03-01  
(72) **Designer:** EYEPOC AS, Tvetenveien 30B, 0666 OSLO  
(30) **Prioritet:** 2019.06.28, NO, 201808577, 1, 2  
(55) **Designavbildninger:**



2.1

|      |                                |   |
|------|--------------------------------|---|
| (11) | <b>Reg.nr.:</b>                | <b>DM/202247</b>  |
| (21) | <b>Søkn.nr.:</b>               | 20191086  |
| (22) | <b>Inngitt i WIPO:</b>         | 2018.12.21  |
| (15) | <b>Registrert i WIPO:</b>      | 2018.12.21  |
| (24) | <b>Løpedag:</b>                | 2018.12.21  |
| (43) | <b>Allm. tilgj.:</b>           | 2019.08.16  |
| (15) | <b>Besluttet gjeldende NO:</b> | 2019.08.23  |
| (45) | <b>Kunngjort NO:</b>           | 2019.09.09  |
| (18) | <b>Reg. gjelder til:</b>       | 2023.12.21  |
| (73) | <b>Innehaver:</b>              | François Boisvert, 7461, 5E Avenue, H7R 2Z1 LAVAL, Canada |

**Design 1**

|      |                            |  |
|------|----------------------------|--|
| (54) | <b>Produkt:</b>            | Fixing hook  |
| (51) | <b>Klasse:</b>             | 08-08  |
| (72) | <b>Designer:</b>           | François Boisvert, 7461, 5E Avenue, H7R 2Z1 LAVAL, Canada (CA) |
| (55) | <b>Designavbildninger:</b> |  |

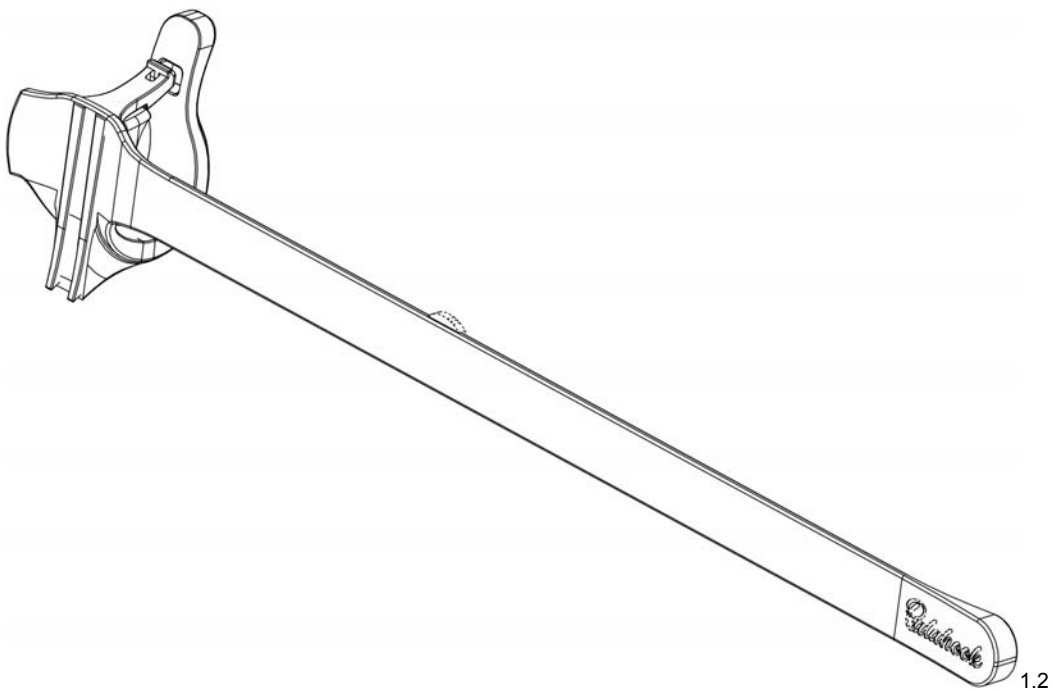
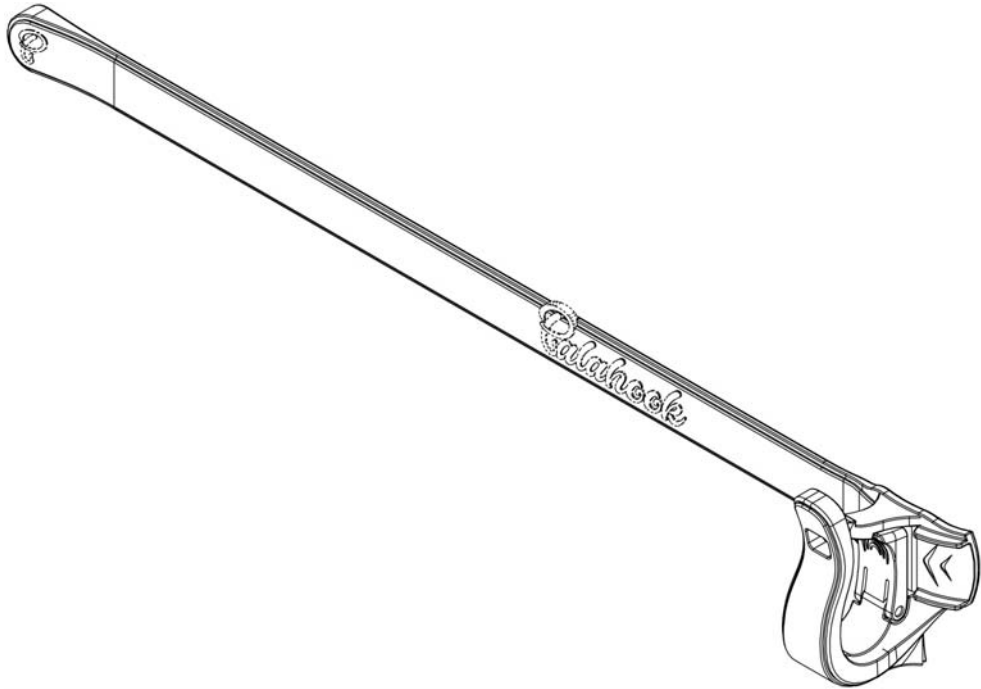

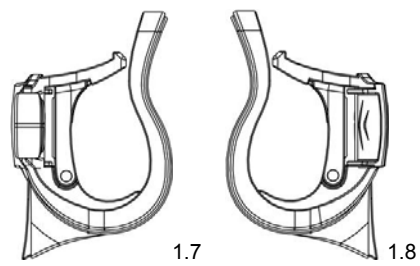
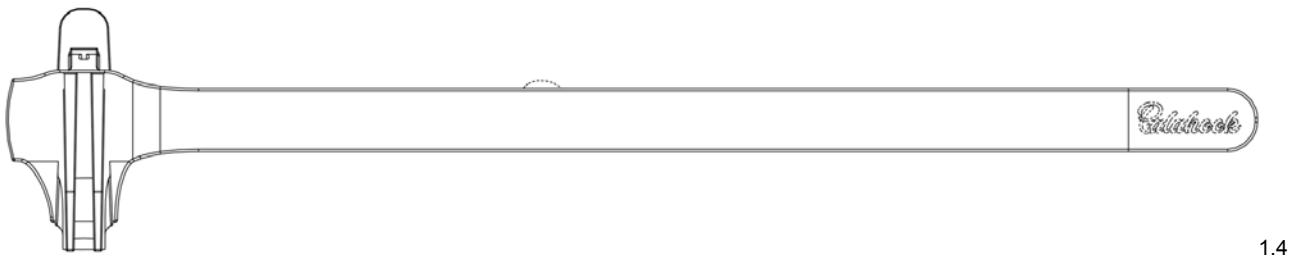
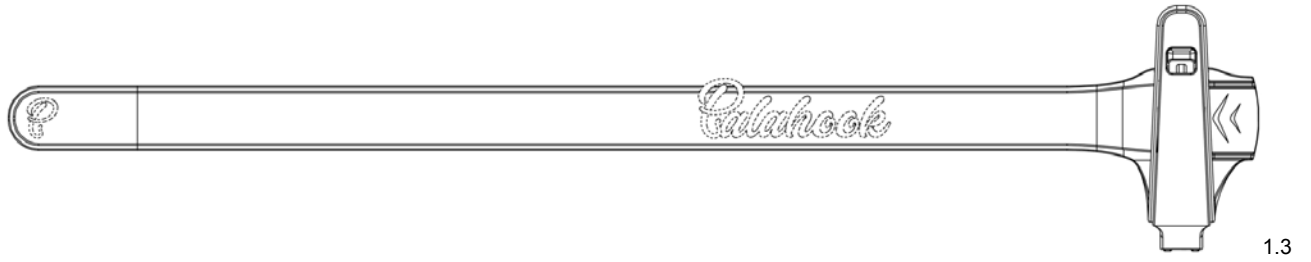

|                                     |  |
|-------------------------------------|--|
| (11) <b>Reg.nr.:</b>                | <b>DM/202250</b>   |
| (21) <b>Søkn.nr.:</b>               | 20191087   |
| (22) <b>Inngitt i WIPO:</b>         | 2018.09.26   |
| (15) <b>Registrert i WIPO:</b>      | 2018.09.26   |
| (24) <b>Løpedag:</b>                | 2018.09.26   |
| (43) <b>Allm. tilgj.:</b>           | 2019.08.16   |
| (15) <b>Besluttet gjeldende NO:</b> | 2019.08.23   |
| (45) <b>Kunngjort NO:</b>           | 2019.09.09   |
| (18) <b>Reg. gjelder til:</b>       | 2023.09.26   |
| (73) <b>Innehaver:</b>              | VITALCHAINS CORPORATION, 2710 Sandhill Road, CA94025 MENLO PARK, USA |
| (50) <b>Anmerkninger:</b>           | Registreringen gjelder samregistrering.                              |

**Design 1**

|                       |   |
|-----------------------|---|
| (54) <b>Produkt:</b>  | Electronic stethoscope  |
| (51) <b>Klasse:</b>   | 24-02   |
| (72) <b>Designer:</b> | Tzu-Chih Lin, No.169, Lushi 1st St., 307 QIONGLIN TOWNSHIP(HSINCHU COUNTY), Kina (CN)<br>Kun-Hsi Tsai, No. 12, Sec. 2, Shengyi Rd., 302 ZHUBEI CITY(HSINCHU COUNTY), Kina (CN)<br>Ching-Heng Lin, 3F., No. 26, Aly. 112, Ln. 352, Ren'ai Rd., Yonghe Dist., 234 NEW TAIPEI CITY, Kina (CN)<br>Yu-Cheng Huang, No. 99, Lushi 1st St., Qionglin Township, 307 HSINCHU COUNTY, Kina (CN) |

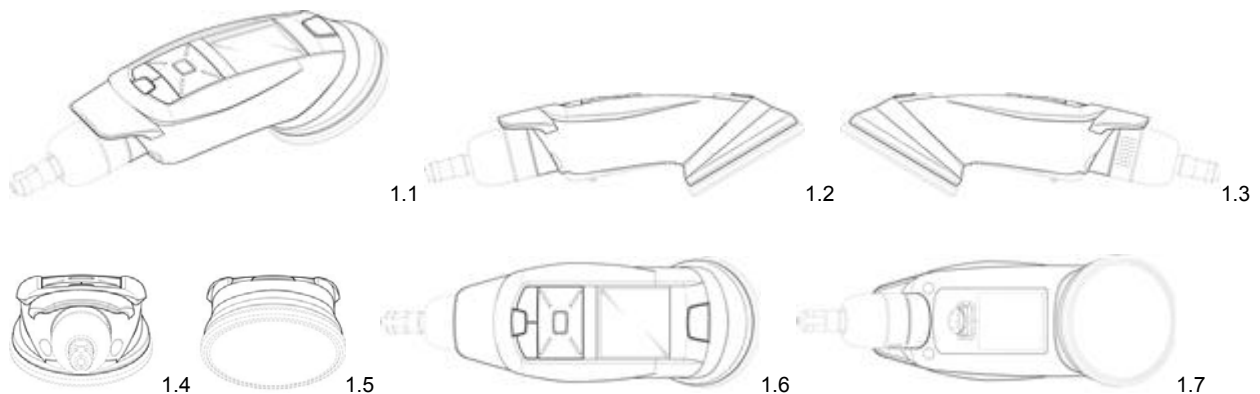
(55) **Designavbildninger:****Design 2**

|                       |   |
|-----------------------|---|
| (54) <b>Produkt:</b>  | Electronic stethoscope  |
| (51) <b>Klasse:</b>   | 24-02   |
| (72) <b>Designer:</b> | Yi-Ting Huang, 2F., No. 9, Ln. 27, Xinxing Rd., 302 ZHUBEI CITY, Kina (CN)<br>Tzu-Chih Lin, No.169, Lushi 1st St., 307 QIONGLIN TOWNSHIP(HSINCHU COUNTY), Kina (CN)<br>Ching-Heng Lin, 3F., No. 26, Aly. 112, Ln. 352, Ren'ai Rd., Yonghe Dist., 234 NEW TAIPEI CITY, Kina (CN) |

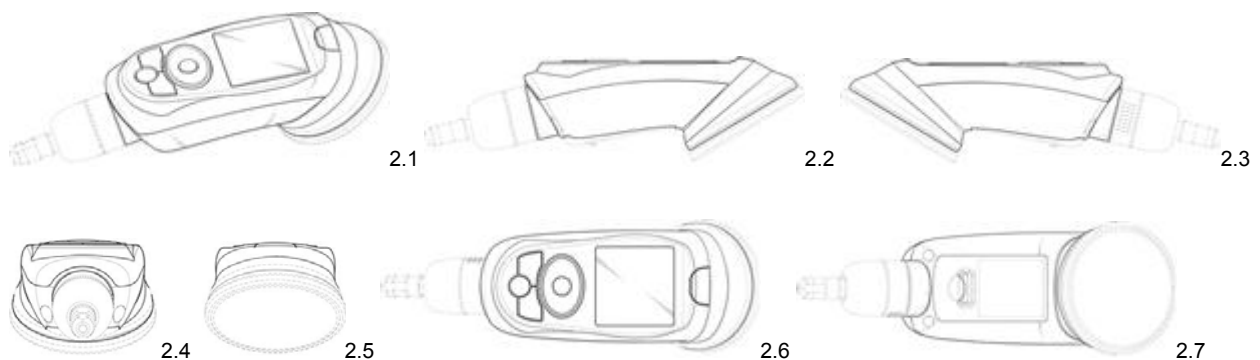
(55) **Designavbildninger:**

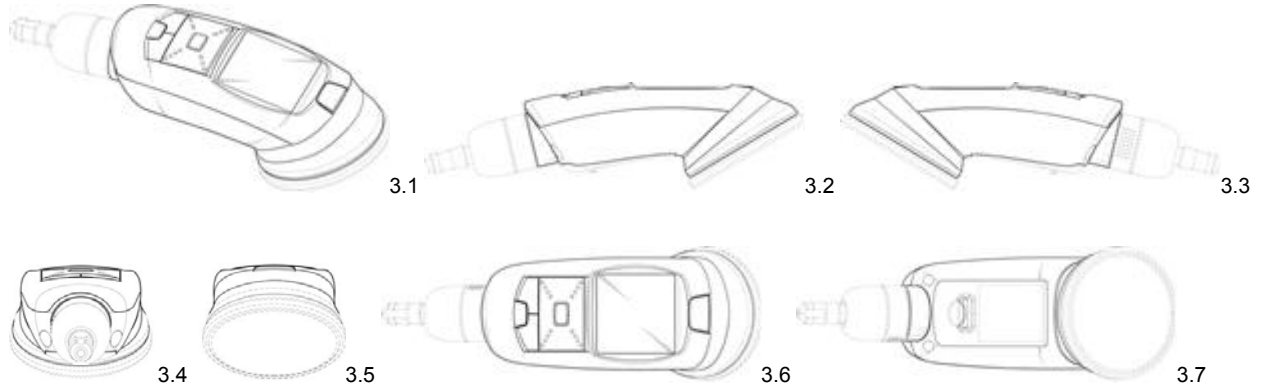
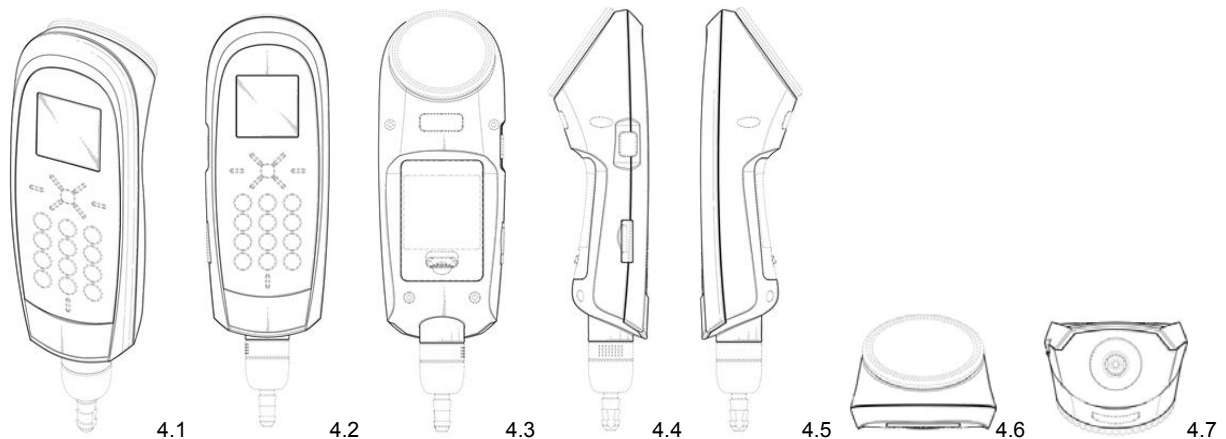
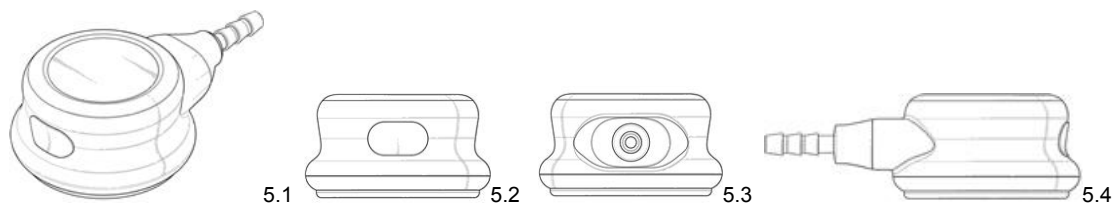
**Design 3**(54) **Produkt:** Electronic stethoscope(51) **Klasse:** 24-02(72) **Designer:** Tzu-Chih Lin, No.169, Lushi 1st St., 307 QIONGLIN TOWNSHIP(HSINCHU COUNTY), Kina (CN)  
Yu-Cheng Huang, No. 99, Lushi 1st St., Qionglin Township, 307 HSINCHU COUNTY, Kina (CN)  
Yu-Ting Tai, 3F., No. 14, Zhongming Rd., Zhongli Dist., 320 TAOYUAN CITY(HSINCHU COUNTY), Kina (CN)(55) **Designavbildninger:****Design 4**(54) **Produkt:** Electronic stethoscope(51) **Klasse:** 24-02(72) **Designer:** Tzu-Chih Lin, No.169, Lushi 1st St., 307 QIONGLIN TOWNSHIP(HSINCHU COUNTY), Kina (CN)  
Yu-Cheng Huang, No. 99, Lushi 1st St., Qionglin Township, 307 HSINCHU COUNTY, Kina (CN)  
Ke-Wen Wang, 1F., No. 38, Guosheng 2nd St., Taoyuan Dist., 330 TAOYUAN CITY, Kina (CN)(55) **Designavbildninger:****Design 5**(54) **Produkt:** Electronic stethoscope(51) **Klasse:** 24-02(72) **Designer:** Tzu-Chih Lin, No.169, Lushi 1st St., 307 QIONGLIN TOWNSHIP(HSINCHU COUNTY), Kina (CN)  
Kun-Hsi Tsai, No. 12, Sec. 2, Shengyi Rd., 302 ZHUBEI CITY(HSINCHU COUNTY), Kina (CN)(55) **Designavbildninger:**



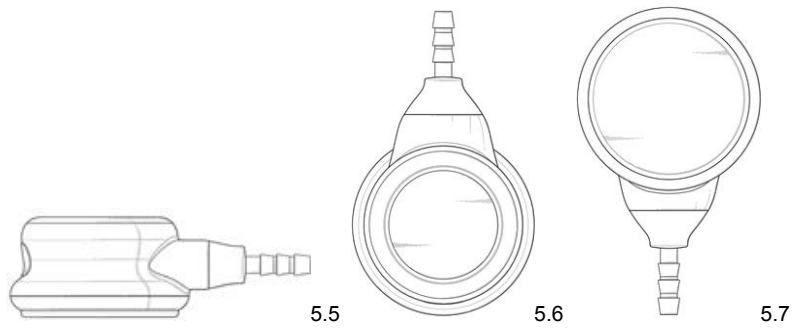

|      |                                |  |
|------|--------------------------------|--|
| (11) | <b>Reg.nr.:</b>                | <b>DM/202255</b>                                       |
| (21) | <b>Søkn.nr.:</b>               | 20191088   |
| (22) | <b>Inngitt i WIPO:</b>         | 2018.10.10   |
| (15) | <b>Registrert i WIPO:</b>      | 2018.10.10   |
| (24) | <b>Løpedag:</b>                | 2018.10.10   |
| (43) | <b>Allm. tilgj.:</b>           | 2019.08.16   |
| (15) | <b>Besluttet gjeldende NO:</b> | 2019.08.23   |
| (45) | <b>Kunngjort NO:</b>           | 2019.09.09   |
| (18) | <b>Reg. gjelder til:</b>       | 2023.10.10   |
| (73) | <b>Innehaver:</b>              | Sayyid Nadimi, 1200 Avenue H E, TX76011 ARLINGTON, USA |

**Design 1**

|      |                            |   |
|------|----------------------------|---|
| (54) | <b>Produkt:</b>            | Container for tobacco products                              |
| (51) | <b>Klasse:</b>             | 09-03   |
| (72) | <b>Designer:</b>           | Sayyid Nadimi, 1200 Avenue H E, TX76011 ARLINGTON, USA (US) |
| (30) | <b>Prioritet:</b>          | 2018.04.10, US, 29643680, 1                                 |
| (55) | <b>Designavbildninger:</b> |   |



1.1



1.2



1.3



1.4



1.5



1.6



1.7



1.8

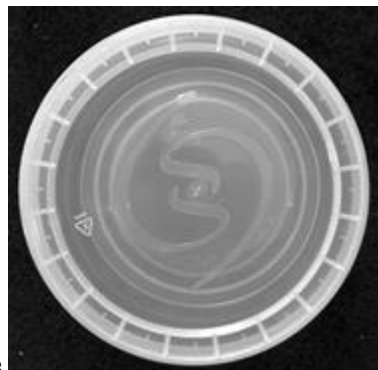

1.9



1.10



1.11

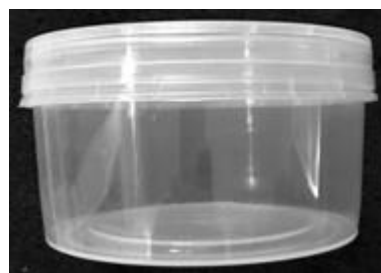

1.12



1.13



1.14

|      |                                |   |
|------|--------------------------------|---|
| (11) | <b>Reg.nr.:</b>                | <b>DM/202258</b>  |
| (21) | <b>Søkn.nr.:</b>               | 20191089  |
| (22) | <b>Inngitt i WIPO:</b>         | 2019.04.17  |
| (15) | <b>Registrert i WIPO:</b>      | 2019.04.17  |
| (24) | <b>Løpedag:</b>                | 2019.04.17  |
| (43) | <b>Allm. tilgj.:</b>           | 2019.08.16  |
| (15) | <b>Besluttet gjeldende NO:</b> | 2019.08.23  |
| (45) | <b>Kunngjort NO:</b>           | 2019.09.09  |
| (18) | <b>Reg. gjelder til:</b>       | 2024.04.17  |
| (73) | <b>Innehaver:</b>              | MIR SRL - MEDICAL INTERNATIONAL RESEARCH, Via del Maggiolino, 125, 00155 ROMA, Italia |

**Design 1**

|      |                            |  |
|------|----------------------------|--|
| (54) | <b>Produkt:</b>            | Medical instrument   |
| (51) | <b>Klasse:</b>             | 24-02  |
| (72) | <b>Designer:</b>           | Paolo Boschetti Sacco, Viale Cortina d'Ampezzo, 204, 00135 ROMA, Italia (IT) |
| (30) | <b>Prioritet:</b>          | 2018.10.29, EM, 005812369, 1   |
| (55) | <b>Designavbildninger:</b> |  |



1.1

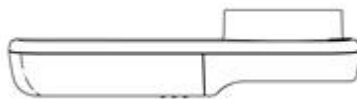

1.2

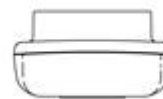

1.3

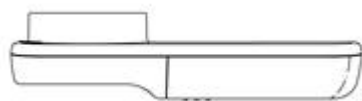

1.4



1.5

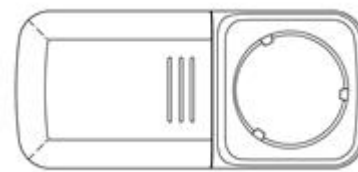

1.6

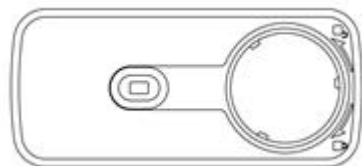

1.7

|      |                                |   |
|------|--------------------------------|---|
| (11) | <b>Reg.nr.:</b>                | <b>DM/202264</b>  |
| (21) | <b>Søkn.nr.:</b>               | 20191090  |
| (22) | <b>Inngitt i WIPO:</b>         | 2018.11.22  |
| (15) | <b>Registrert i WIPO:</b>      | 2018.11.22  |
| (24) | <b>Løpedag:</b>                | 2018.11.22  |
| (43) | <b>Allm. tilgj.:</b>           | 2019.08.16  |
| (15) | <b>Besluttet gjeldende NO:</b> | 2019.08.23  |
| (45) | <b>Kunngjort NO:</b>           | 2019.09.09  |
| (18) | <b>Reg. gjelder til:</b>       | 2023.11.22  |
| (73) | <b>Innehaver:</b>              | PSA AUTOMOBILES SA, 2-10 Boulevard de l'Europe, 78300 POISSY, Frankrike |
| (50) | <b>Anmerkninger:</b>           | Registreringen gjelder samregistrering.                                 |

**Design 1**

|      |                            |  |
|------|----------------------------|--|
| (54) | <b>Produkt:</b>            | Automobile   |
| (51) | <b>Klasse:</b>             | 12-08  |
| (72) | <b>Designer:</b>           | Jean Pierre Ploue, Route de Gisy, 78140 VELIZY, Frankrike (FR) |
| (30) | <b>Prioritet:</b>          | 2018.06.28, EM, 005328440, 1, 2, 3                             |
| (55) | <b>Designavbildninger:</b> |  |



1.1





*NIVEAU 3N - Inspiration 2*

1.5



*NIVEAU 3N - Inspiration 2*

1.6

**Design 2**

(54) **Produkt:** Automobile  
(51) **Klasse:** 12-08  
(72) **Designer:** Jean Pierre Ploue, Route de Gisy, 78140 VELIZY, Frankrike (FR)  
(30) **Prioritet:** 2018.06.28, EM, 005328440, 1, 2, 3  
(55) **Designavbildninger:**



VIEW 1 - Front view 1

2.1



VIEW 2 - Top view 1

2.2





*NIVEAU7 - Inspiration 5*

2.3



*NIVEAU7 - Inspiration 6*

2.4



*NIVEAU7 - Inspiration 8*

2.5

*MINICAR - DESIGN 3*

2.6

**Design 3**

- (54) **Produkt:** Car interior  
(51) **Klasse:** 12-16  
(72) **Designer:** Jean Pierre Ploue, Route de Gisy, 78140 VELIZY, Frankrike (FR)  
(30) **Prioritet:** 2018.06.28, EM, 005328440, 1, 2, 3  
(55) **Designavbildninger:**

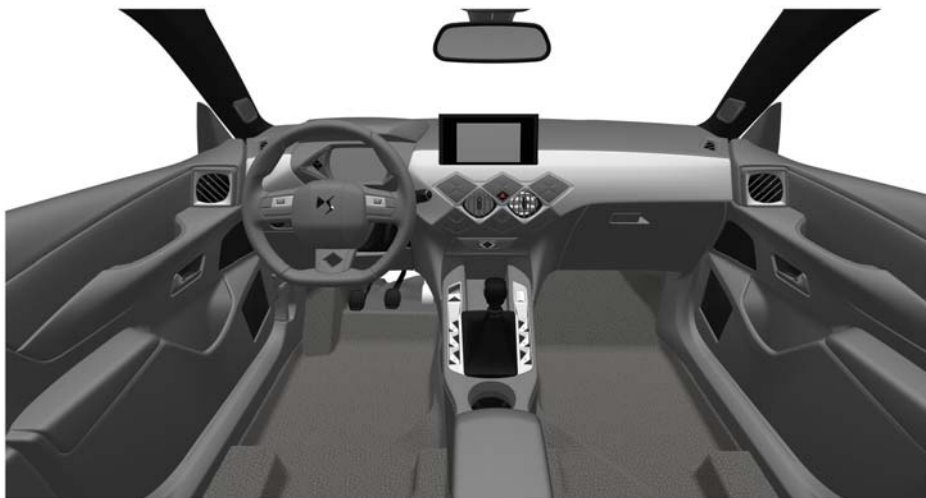

3.1

**Design 4**

- (54) **Produkt:** Dashboard for a vehicle  
(51) **Klasse:** 12-16  
(72) **Designer:** Jean Pierre Ploue, Route de Gisy, 78140 VELIZY, Frankrike (FR)  
(55) **Designavbildninger:**



4.1

**Design 5**

- (54) **Produkt:** Central console for a vehicle  
(51) **Klasse:** 12-16  
(72) **Designer:** Jean Pierre Ploue, Route de Gisy, 78140 VELIZY, Frankrike (FR)  
(55) **Designavbildninger:**

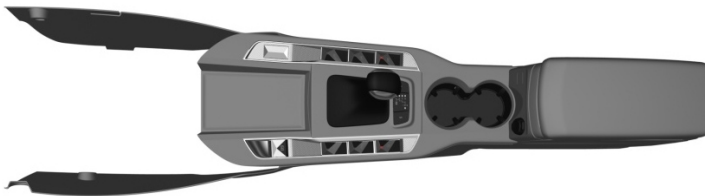

5.1



5.2

**Design 6**

- (54) **Produkt:** Interior door panel for a vehicle  
(51) **Klasse:** 12-16  
(72) **Designer:** Jean Pierre Ploue, Route de Gisy, 78140 VELIZY, Frankrike (FR)  
(55) **Designavbildninger:**



6.1



6.2

|      |                                |  |
|------|--------------------------------|--|
| (11) | <b>Reg.nr.:</b>                | <b>DM/202281</b>   |
| (21) | <b>Søkn.nr.:</b>               | 20191091   |
| (22) | <b>Inngitt i WIPO:</b>         | 2018.10.12   |
| (15) | <b>Registrert i WIPO:</b>      | 2018.10.12   |
| (24) | <b>Løpedag:</b>                | 2018.10.12   |
| (43) | <b>Allm. tilgj.:</b>           | 2019.08.16   |
| (15) | <b>Besluttet gjeldende NO:</b> | 2019.08.23   |
| (45) | <b>Kunngjort NO:</b>           | 2019.09.09   |
| (18) | <b>Reg. gjelder til:</b>       | 2023.10.12   |
| (73) | <b>Innehaver:</b>              | NORWEGIAN SPECIAL MISSION AS, Postboks 110, 2061 GARDERMOEN, Norge |

**Design 1**

|      |                            |  |
|------|----------------------------|--|
| (54) | <b>Produkt:</b>            | Computer terminal  |
| (51) | <b>Klasse:</b>             | 14-02  |
| (72) | <b>Designer:</b>           | Ulf Tølfen, Torsnesveien 101, 1634 GAMLE FREDRIKSTAD<br>Frank Robin Danielsen, Linneavegen 23, 2052 JESSHEIM<br>Bjørge Jacobsen, Orrekullindustriväg 19, 42536 HISINGS KÄRRÄ, Sverige (SE)<br>Kjetil Huuse, Märvegen 18, 1929 AULI |
| (30) | <b>Prioritet:</b>          | 2018.04.13, US, US29644008, 1  |
| (55) | <b>Designavbildninger:</b> |  |

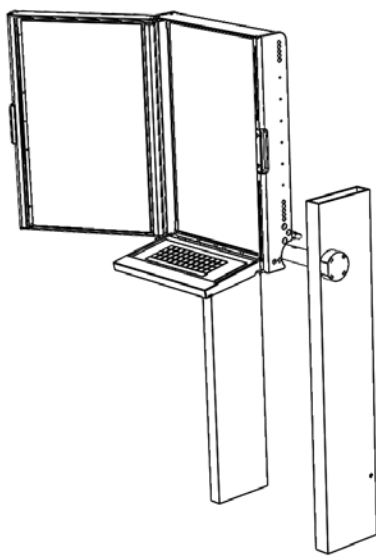

1.1

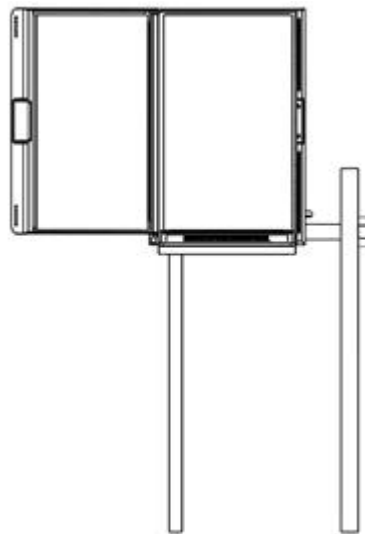

1.2

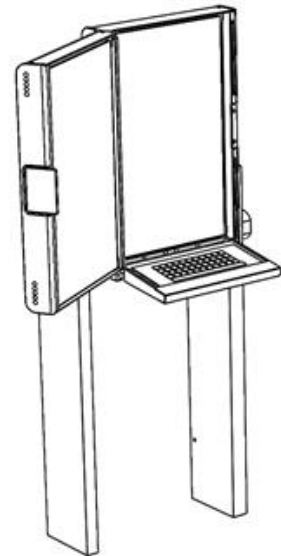

1.3

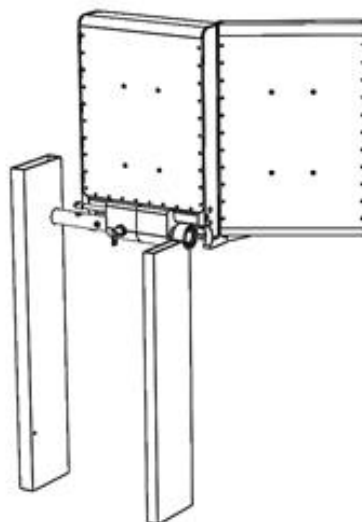

1.4

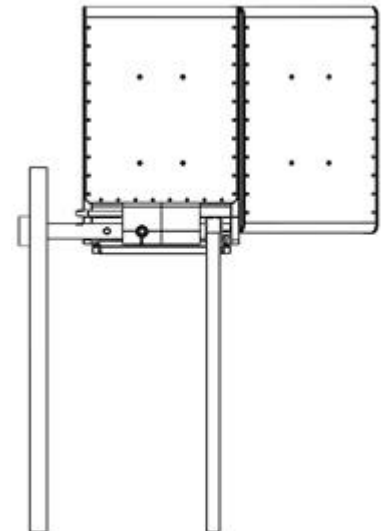

1.5

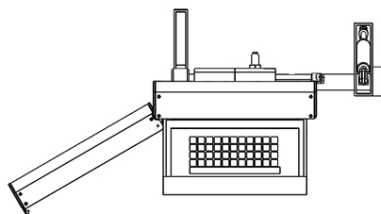

1.6

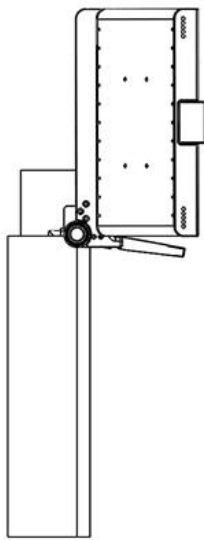

1.7

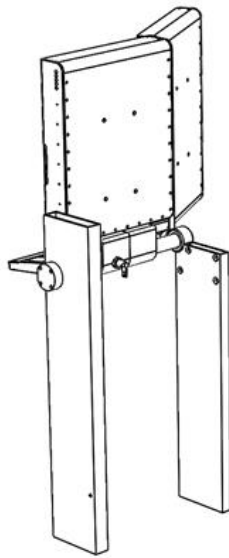

1.8

|      |                                |   |
|------|--------------------------------|---|
| (11) | <b>Reg.nr.:</b>                | <b>DM/202283</b>  |
| (21) | <b>Søkn.nr.:</b>               | 20191092  |
| (22) | <b>Inngitt i WIPO:</b>         | 2019.07.04  |
| (15) | <b>Registrert i WIPO:</b>      | 2019.07.04  |
| (24) | <b>Løpedag:</b>                | 2019.07.04  |
| (43) | <b>Allm. tilgj.:</b>           | 2019.08.16  |
| (15) | <b>Besluttet gjeldende NO:</b> | 2019.08.23  |
| (45) | <b>Kunngjort NO:</b>           | 2019.09.09  |
| (18) | <b>Reg. gjelder til:</b>       | 2024.07.04  |
| (73) | <b>Innehaver:</b>              | Vaillant GmbH, Berghauser Strasse 40, 42859 REMSCHEID, Tyskland |

**Design 1**

|      |                            |  |
|------|----------------------------|--|
| (54) | <b>Produkt:</b>            | Water heater [electric]  |
| (51) | <b>Klasse:</b>             | 23-03  |
| (72) | <b>Designer:</b>           | Tim Richter, c/o Vaillant GmbH Berghauser Strasse 40, 42859 REMSCHEID, Tyskland (DE) |
| (30) | <b>Prioritet:</b>          | 2019.02.27, EM, 1, 1   |
| (55) | <b>Designavbildninger:</b> |  |





1.7

|                                     |   |
|-------------------------------------|---|
| (11) <b>Reg.nr.:</b>                | <b>DM/202285</b>                                  |
| (21) <b>Søkn.nr.:</b>               | 20191093  |
| (22) <b>Inngitt i WIPO:</b>         | 2018.10.18  |
| (15) <b>Registrert i WIPO:</b>      | 2018.10.18  |
| (24) <b>Løpedag:</b>                | 2018.10.18  |
| (43) <b>Allm. tilgj.:</b>           | 2019.08.16  |
| (15) <b>Besluttet gjeldende NO:</b> | 2019.08.23  |
| (45) <b>Kunngjort NO:</b>           | 2019.09.09  |
| (18) <b>Reg. gjelder til:</b>       | 2023.10.18  |
| (73) <b>Innehaver:</b>              | MENU A/S, Hamborg Plads 2, 2150 NORDHAVN, Danmark |
| (50) <b>Anmerkninger:</b>           | Registreringen gjelder samregistrering.           |

**Design 1**

|                                 |  |
|---------------------------------|--|
| (54) <b>Produkt:</b>            | Flower vase  |
| (51) <b>Klasse:</b>             | 11-02  |
| (72) <b>Designer:</b>           | Gabriel Tan, 23 Hythe Road, 557504 SINGAPORE, Singapore (SG) |
| (55) <b>Designavbildninger:</b> |  |

**Design 2**

|                                 |  |
|---------------------------------|--|
| (54) <b>Produkt:</b>            | Flower vase  |
| (51) <b>Klasse:</b>             | 11-02  |
| (72) <b>Designer:</b>           | Gabriel Tan, 23 Hythe Road, 557504 SINGAPORE, Singapore (SG) |
| (55) <b>Designavbildninger:</b> |  |





## Fornyelse av registreringer

(11) **Reg.nr.:** 078764  
 (18) **Reg. gjelder til:** 2024.08.19  
 (73) **Innehaver:**  
 Unilever NV, Weena 455, 3013AL ROTTERDAM,  
 Nederland  
 (74) **Fullmektig:**  
 ZACCO NORWAY AS, Postboks 2003 Vika, 0125  
 OSLO, Norge

(11) **Reg.nr.:** 082024  
 (18) **Reg. gjelder til:** 2024.08.13  
 (73) **Innehaver:**  
 Electrolux Home Products Corp NV, Belgicastraat 17,  
 1930 ZAVENTEM, Belgia  
 (74) **Fullmektig:**  
 OSLO PATENTKONTOR AS, Postboks 7007 M, 0306  
 OSLO, Norge

(11) **Reg.nr.:** 084613  
 (18) **Reg. gjelder til:** 2024.10.07  
 (73) **Innehaver:**  
 NORGESMØLLENE AS, Postboks 1911 Nordnes,  
 5817 BERGEN, Norge  
 (74) **Fullmektig:**  
 ACAPO AS, Postboks 1880 Nordnes, 5817 BERGEN,  
 Norge

(11) **Reg.nr.:** 084716  
 (18) **Reg. gjelder til:** 2024.08.27  
 (73) **Innehaver:**  
 MODELLFABRIKKEN AS, Maridalsveien 3, 0178  
 OSLO, Norge

(11) **Reg.nr.:** DM/084114  
 (18) **Reg. gjelder til:** 2019.08.06  
 (73) **Innehaver:**  
 HERMES SELLIER (SOCIÉTÉ PAR ACTIONS  
 SIMPLIFIÉE), 24 rue du Faubourg Saint-Honoré,  
 75008 PARIS, Frankrike

(11) **Reg.nr.:** DM/084117  
 (18) **Reg. gjelder til:** 2019.08.07  
 (73) **Innehaver:**  
 HERMES SELLIER (SOCIÉTÉ PAR ACTIONS  
 SIMPLIFIÉE), 24 rue du Faubourg Saint-Honoré,  
 75008 PARIS, Frankrike

(11) **Reg.nr.:** DM/084147  
 (18) **Reg. gjelder til:** 2019.08.06  
 (73) **Innehaver:**  
 Ferrari SpA, Via Emilia Est, 1163, 41100 MODENA,  
 Italia

(11) **Reg.nr.:** DM/084153  
 (18) **Reg. gjelder til:** 2019.08.11  
 (73) **Innehaver:**  
 Diadora Sport Srl, Via Montello, 80, 31031 CAERANO  
 DI SAN MARCO (TV), Italia

(11) **Reg.nr.:** DM/084159  
 (18) **Reg. gjelder til:** 2019.08.10  
 (73) **Innehaver:**  
 Koninklijke Philips N.V., High Tech Campus 5, 5656AE  
 EINDHOVEN, Nederland

(11) **Reg.nr.:** DM/084166  
 (18) **Reg. gjelder til:** 2019.07.17  
 (73) **Innehaver:**  
 Novartis AG, Postfach, 4002 BASEL, Sveits

(11) **Reg.nr.:** DM/084184  
 (18) **Reg. gjelder til:** 2019.08.13  
 (73) **Innehaver:**  
 CORIOLIS SARL, 22, rue Charles Graindorge, 93170  
 BAGNOLET, Frankrike

(11) **Reg.nr.:** DM/084196  
 (18) **Reg. gjelder til:** 2019.08.13  
 (73) **Innehaver:**  
 NORKA Norddeutsche Kunststoff- und Elektro-  
 Gesellschaft Stäcker mbH & Co KG, Lange Str. 1,  
 27313 DÖRVERDEN, Tyskland

(11) **Reg.nr.:** DM/084230  
 (18) **Reg. gjelder til:** 2019.08.04  
 (73) **Innehaver:**  
 BAHAG BAUS HANDELSGES. AG -  
 ZWEIGNIEDERLASSUNG MANNHEIM,  
 Gutenbergstrasse 21, 68167 MANNHEIM, Tyskland

(11) **Reg.nr.:** DM/084310  
 (18) **Reg. gjelder til:** 2019.08.11  
 (73) **Innehaver:**  
 Rimowa GmbH, Mathias-Brüggen-Strasse 118, 50829  
 KÖLN, Tyskland

(11) **Reg.nr.:** DM/084468  
 (18) **Reg. gjelder til:** 2019.08.04  
 (73) **Innehaver:**  
 BAYER ANIMAL HEALTH GMBH, Kaiser-Wilhelm-  
 Allee 10, 51373 LEVERKUSEN, Tyskland

(11) **Reg.nr.:** DM/084484  
 (18) **Reg. gjelder til:** 2019.06.25  
 (73) **Innehaver:**  
 ORTHEX SWEDEN AB, Box 6, 36221 TINGSRYD,  
 Sverige

(11) **Reg.nr.:** DM/084698  
 (18) **Reg. gjelder til:** 2019.08.05  
 (73) **Innehaver:**  
 NORTH GRADE AB, Kuttervägen 3, 91932 ASELE,  
 Sverige

(11) **Reg.nr.:** **DM/084836**  
(18) **Reg. gjelder til:** 2019.08.06  
(73) **Innehaver:**  
LUMINA ITALIA S.R.L., Via Casorezzo, 63, 20010  
ARLUNO, Italia

---

(11) **Reg.nr.:** **DM/084879**  
(18) **Reg. gjelder til:** 2019.08.06  
(73) **Innehaver:**  
Ferrari SpA, Via Emilia Est, 1163, 41100 MODENA,  
Italia

---

## Overdragelser

Endring av innehaver, eller av innehavers navn og/eller adresse, i allment tilgjengelige designsøknader og registrerte design, jf. designloven § 54 og designforskriften § 20.

(21) **Søknadsnr.** 20190347  
(71) **Søker:**  
KRISTNE KONGREGASJON I NORGE, c/o Leander  
Zeiner, Fuglebakk 3, 3482 TOFTE, Norge  
**Melding innkommet patentstyret:**  
2019.07.21

---

(11) **Reg.nr.:** 081778  
(21) **Søknadsnr.** 20090006  
(73) **Innehaver:**  
RYDD REOLSYSTEM AS, Borgundfjordveien 58, 6017  
ÅLESUND, Norge  
**Melding innkommet patentstyret:**  
2019.07.16

---

(11) **Reg.nr.:** 081963  
(21) **Søknadsnr.** 20090222  
(73) **Innehaver:**  
Winnington AB, Stationsvagen 11, 52374 HÖKERUM,  
Sverige  
(74) **Fullmektig:**  
ZACCO NORWAY AS, Postboks 2003 Vika, 0125  
OSLO, Norge  
**Melding innkommet patentstyret:**  
2019.07.17

---

(11) **Reg.nr.:** 082402  
(21) **Søknadsnr.** 20090624  
(73) **Innehaver:**  
FLEX DESIGN AS, c/o Handeland Gard AS,  
Handelandsvegen 75, 5451 VALEN, Norge  
(74) **Fullmektig:**  
PROTECTOR IP AS, Pilestredet 33, 0166 OSLO, Norge  
**Melding innkommet patentstyret:**  
2019.08.09

---

## Endringer i fullmaktsforhold

- (21) **Søknadsnr.** 20180895  
(71) **Søker:**  
Hangzhou Ruiyi Outdoor Leisure Products Co.,LTD,  
169wuchang Avenue, Yuhang District, 310023  
HANGZHOU, Kina  
(74) **Fullmektig:**  
ACAPO AS, Postboks 1880 Nordnes, 5817 BERGEN,  
Norge  
**Melding innkommet patentstyret:**  
2019.08.08
- 

- (11) **Reg.nr.:** 081963  
(21) **Søknadsnr.** 20090222  
(73) **Innehaver:**  
Winnington AB, Stationsvagen 11, 52374 HÖKERUM,  
Sverige  
(74) **Fullmektig:**  
ZACCO NORWAY AS, Postboks 2003 Vika, 0125  
OSLO, Norge  
**Melding innkommet patentstyret:**  
2019.07.17
-

**Slettede, utgåtte og opphørte nasjonale designregistreringer**

|      |          |        |      |          |        |
|------|----------|--------|------|----------|--------|
| (11) | Reg.nr.: | 075147 | (11) | Reg.nr.: | 084353 |
| (11) | Reg.nr.: | 075163 | (11) | Reg.nr.: | 084362 |
| (11) | Reg.nr.: | 075245 | (11) | Reg.nr.: | 084458 |
| (11) | Reg.nr.: | 075319 | (11) | Reg.nr.: | 084462 |
| (11) | Reg.nr.: | 078445 |      |          |        |
| (11) | Reg.nr.: | 078473 |      |          |        |
| (11) | Reg.nr.: | 081676 |      |          |        |
| (11) | Reg.nr.: | 081686 |      |          |        |
| (11) | Reg.nr.: | 081692 |      |          |        |
| (11) | Reg.nr.: | 081696 |      |          |        |
| (11) | Reg.nr.: | 081699 |      |          |        |
| (11) | Reg.nr.: | 081730 |      |          |        |
| (11) | Reg.nr.: | 081868 |      |          |        |
| (11) | Reg.nr.: | 081870 |      |          |        |
| (11) | Reg.nr.: | 081879 |      |          |        |
| (11) | Reg.nr.: | 081885 |      |          |        |
| (11) | Reg.nr.: | 084245 |      |          |        |
| (11) | Reg.nr.: | 084253 |      |          |        |
| (11) | Reg.nr.: | 084254 |      |          |        |
| (11) | Reg.nr.: | 084255 |      |          |        |
| (11) | Reg.nr.: | 084256 |      |          |        |
| (11) | Reg.nr.: | 084257 |      |          |        |
| (11) | Reg.nr.: | 084258 |      |          |        |
| (11) | Reg.nr.: | 084259 |      |          |        |
| (11) | Reg.nr.: | 084260 |      |          |        |
| (11) | Reg.nr.: | 084261 |      |          |        |
| (11) | Reg.nr.: | 084262 |      |          |        |
| (11) | Reg.nr.: | 084263 |      |          |        |
| (11) | Reg.nr.: | 084271 |      |          |        |
| (11) | Reg.nr.: | 084286 |      |          |        |
| (11) | Reg.nr.: | 084287 |      |          |        |
| (11) | Reg.nr.: | 084292 |      |          |        |
| (11) | Reg.nr.: | 084301 |      |          |        |
| (11) | Reg.nr.: | 084307 |      |          |        |
| (11) | Reg.nr.: | 084310 |      |          |        |
| (11) | Reg.nr.: | 084315 |      |          |        |
| (11) | Reg.nr.: | 084316 |      |          |        |

## Slettede, utgåtte og opphørte internasjonale designregistreringer

(11) **Reg.nr.:** DM/082680  
(73) **Innehaver:**  
Armin Bernet Design, Ueberlandstr. 22, 8953  
DIETIKON, Sveits  
(75) **Adresse for korrespondanse:**  
Ammann Patent Attorneys Ltd, Schwarztorstrasse 31,  
3001 BERN, Switzerland (CH)

(11) **Reg.nr.:** DM/082721  
(73) **Innehaver:**  
Pi-Design AG, Kantonsstrasse 100, Postfach 463,  
6234 TRIENGEN, Sveits  
(75) **Adresse for korrespondanse:**  
Schreiber Hahn Sommerlad Partnerschaftsgesellschaft  
von Rechtsanwälten, Niedenau 13-19, 60325  
FRANKFURT AM MAIN, Germany (DE)

(11) **Reg.nr.:** DM/082722  
(73) **Innehaver:**  
GRANBERG AS, Bjoavegen 1442, 5584 BJOA, Norge  
(75) **Adresse for korrespondanse:**  
GRANBERG AS, Bjoavegen 1442, 5584 BJOA

(11) **Reg.nr.:** DM/082743  
(73) **Innehaver:**  
Swatch AG (Swatch SA) (Swatch Ltd), Jakob-Stämpfli-  
Strasse 94, 2502 BIEL/BIENNE, Sveits  
(75) **Adresse for korrespondanse:**  
The Swatch Group SA (The Swatch Group AG) (The  
Swatch Group Ltd), 6, Faubourg du Lac, 2501  
BIEL/BIENNE, Switzerland (CH)

(11) **Reg.nr.:** DM/082781  
(73) **Innehaver:**  
MASCOT INTERNATIONAL A/S, Silkeborgvej 14,  
Pårup, 7442 ENGESVANG, Danmark  
(74) **Fullmektig:**  
Bech-Bruun Law Firm, Værkmestergade 2, 8000  
AARHUS C, Danmark  
(75) **Adresse for korrespondanse:**  
Patrade A/S, Ceresbyen 75, 8000 AARHUS C,  
Denmark (DK)

(11) **Reg.nr.:** DM/082782  
(73) **Innehaver:**  
Irena Kilibarda, Internacionalnih Brigada 7, 11118  
BELGRADE, Serbia  
(75) **Adresse for korrespondanse:**  
Irena Kilibarda, Internacionalnih Brigada 7, 11118  
BELGRADE, Serbia (RS)

(11) **Reg.nr.:** DM/082867  
(73) **Innehaver:**  
AB Plast ApS, Skolemærksvej 12, 3220  
TISVILDELEJE, Danmark  
(75) **Adresse for korrespondanse:**  
DAHL Herning A/S, Kaj Munks Vej 4, 7400 HERNING,  
Denmark (DK)

(11) **Reg.nr.:** DM/082984  
(73) **Innehaver:**  
MICROSOFT MOBILE OY, Keilalahdentie 2-4, 02150  
ESBO, Finland  
(75) **Adresse for korrespondanse:**  
Banner & Witcoff Ltd, 1100 13th Street, N.W,  
DC20005 WASHINGTON, United States of America  
(US)

(11) **Reg.nr.:** DM/083013  
(73) **Innehaver:**  
Ferm Living ApS, Laplandsgade 11, 2300  
KØBENHAVN S, Danmark  
(75) **Adresse for korrespondanse:**  
Sandel Løje & Partnere, Postboks 812, 2100  
KØBENHAVN Ø, Denmark (DK)

(11) **Reg.nr.:** DM/083025  
(73) **Innehaver:**  
MICROSOFT MOBILE OY, Keilalahdentie 2-4, 02150  
ESBO, Finland  
(75) **Adresse for korrespondanse:**  
Banner & Witcoff Ltd, 1100 13th Street, N.W,  
DC20005 WASHINGTON, United States of America  
(US)

(11) **Reg.nr.:** DM/083103  
(73) **Innehaver:**  
Ferm Living ApS, Laplandsgade 11, 2300  
KØBENHAVN S, Danmark  
(75) **Adresse for korrespondanse:**  
Sandel Løje & Partnere, Postboks 812, 2100  
KØBENHAVN Ø, Denmark (DK)

## Innkomet krav om administrativ overprøving

(11) **Reg.nr.:** 086355  
(21) **Søkn.nr.:** 20190004  
(22) **Søknadsdato:** 2019.01.07  
(45) **Reg.dato:** 2019.07.17  
(73) **Innehaver:** TOOLSINVENT AS, c/o Rolf Egil Syrtveit, Torvmosløyfen 32, 4640, SØGNE, NO  
**Kravstiller:** Creative Stuff AB, Basarbovägen 7B, 75273, UPPSALA, SE  
**Krav innkommet:** 2019.07.26

### Design 1

(54) **Produkt:** Bergkile  
(51) **Klasse:** 08-08  
(72) **Designer:** TOOLSINVENT AS, c/o Rolf Egil Syrtveit, Torvmosløyfen 32, 4640 SØGNE  
(55) **Designavbildninger:**



1.1

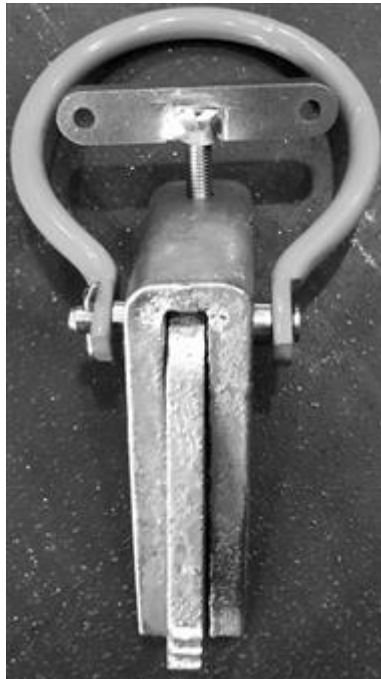

1.2



1.3

## Rettelse

I kunngjøringen av registrering nr. 086343 i Designtidende nr. 16/19, manglet et bilde. Korrekt registrering er som følger:

- (11) **Reg.nr.:** 086343
- (21) **Søkn.nr.:** 20190342
- (22) **Inngitt:** 2019.05.09
- (24) **Løpedag:** 2019.05.09
- (43) **Allm. tilgj.:** 2019.05.09
- (15) **Registrert:** 2019.07.02
- (45) **Kunngjort:** 2019.07.29
- (18) **Reg. gjelder til:** 2024.05.09
- (73) **Innehaver:** Method Products, PBC, 637 Commercial Street, Suite 300, CA94111 SAN FRANCISCO, USA
- (74) **Fullmektig:** PROTECTOR IP AS, Pilestredet 33, 0166 OSLO, Norge
- (50) **Anmerkninger:** Registreringen gjelder samregistrering.

### Design 1

- (54) **Produkt:** Flaske
- (51) **Klasse:** 09-01
- (72) **Designer:** Sean McGreevy, c/o Method Products, PBC 637 Commercial Street, Suite 300, CA94111 SAN FRANCISCO, USA (US)
- (30) **Prioritet:** 2018.11.09, US, 29/669,643, 1, 2
- (55) **Designavbildninger:**

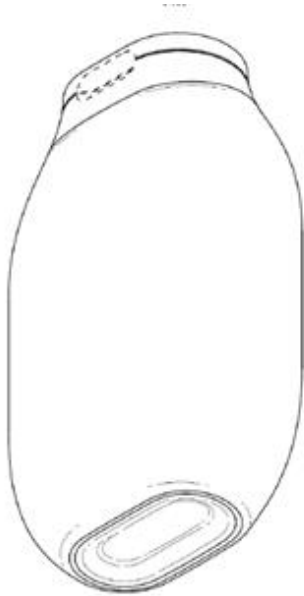

1.1

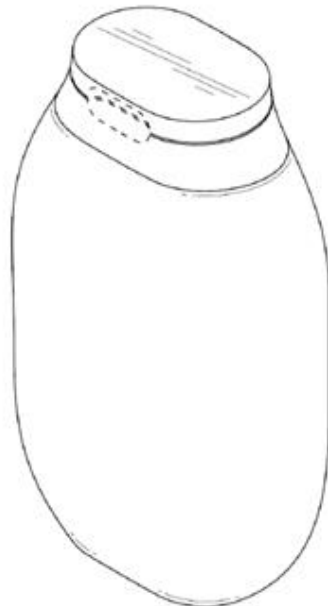

1.2

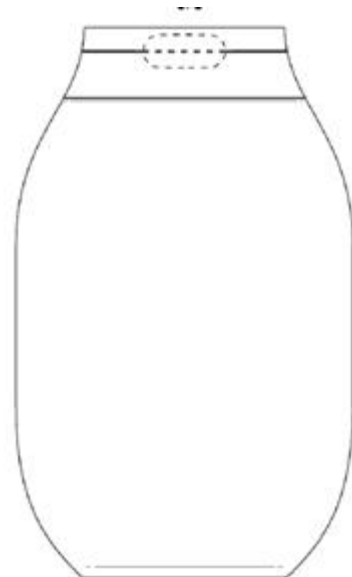

1.3

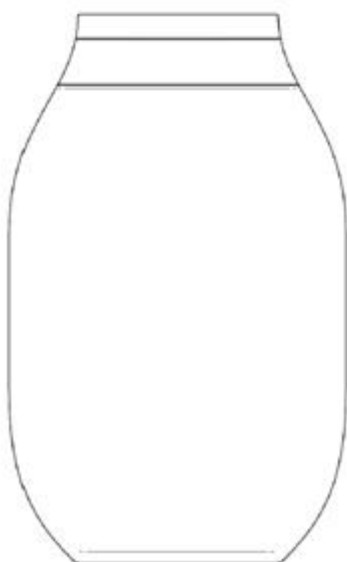

1.4



1.5

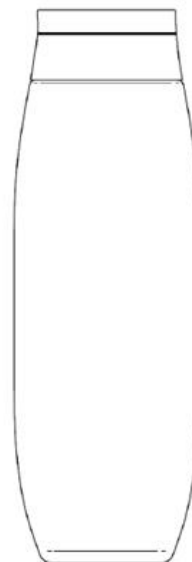

1.6



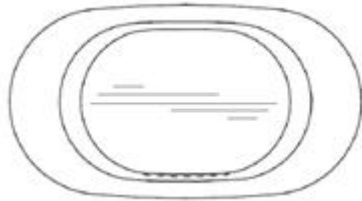

1.7

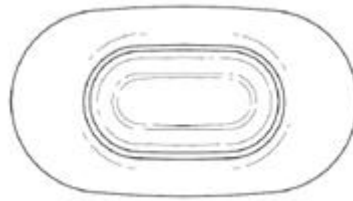

1.8

**Design 2**(54) **Produkt:** Flaske(51) **Klasse:** 09-01(72) **Designer:** Sean McGreevy, c/o Method Products, PBC 637 Commercial Street, Suite 300, CA94111 SAN FRANCISCO, USA (US)(30) **Prioritet:** 2018.11.09, US, 29/669,643, 1, 2(55) **Designavbildninger:**

2.1

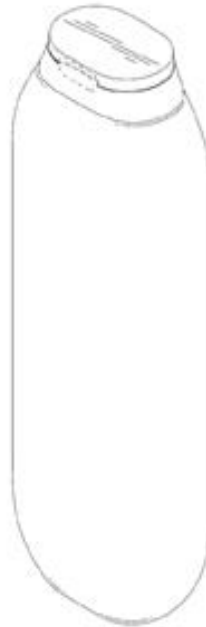

2.2

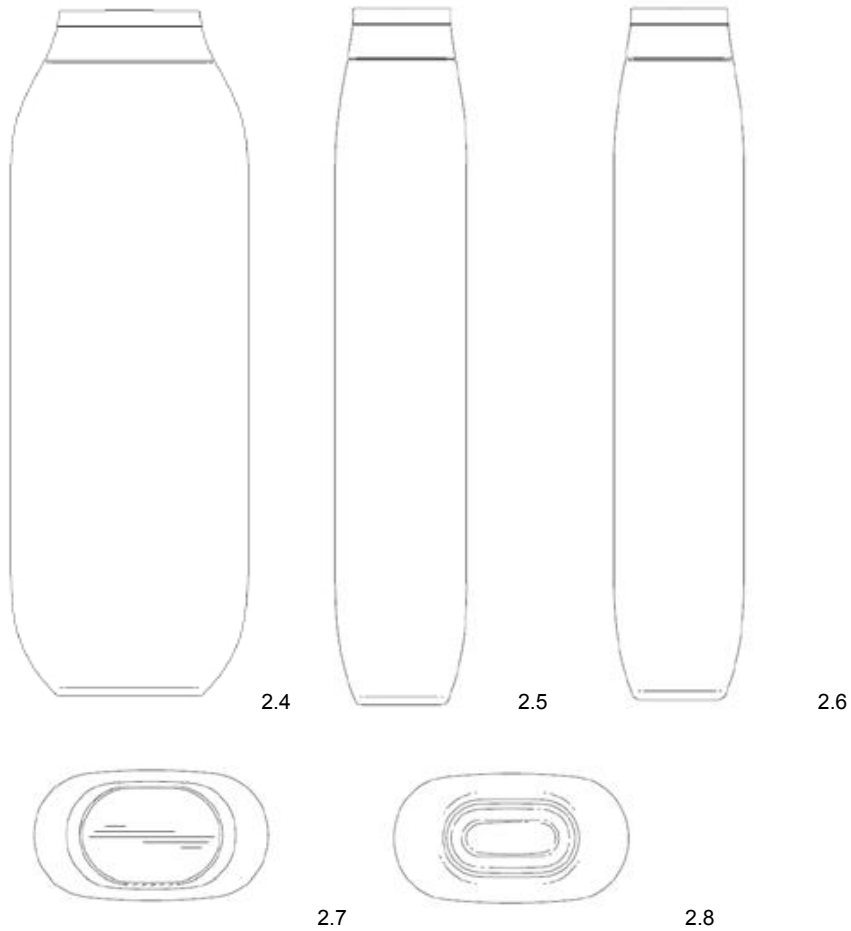

2.3

**Design 3**

- (54) **Produkt:** Flaske  
(51) **Klasse:** 09-01  
(72) **Designer:** Sean McGreevy, c/o Method Products, PBC 637 Commercial Street, Suite 300, CA94111 SAN FRANCISCO, USA (US)  
(30) **Prioritet:** 2018.11.09, US, 29/669,644, 3  
(55) **Designavbildninger:**

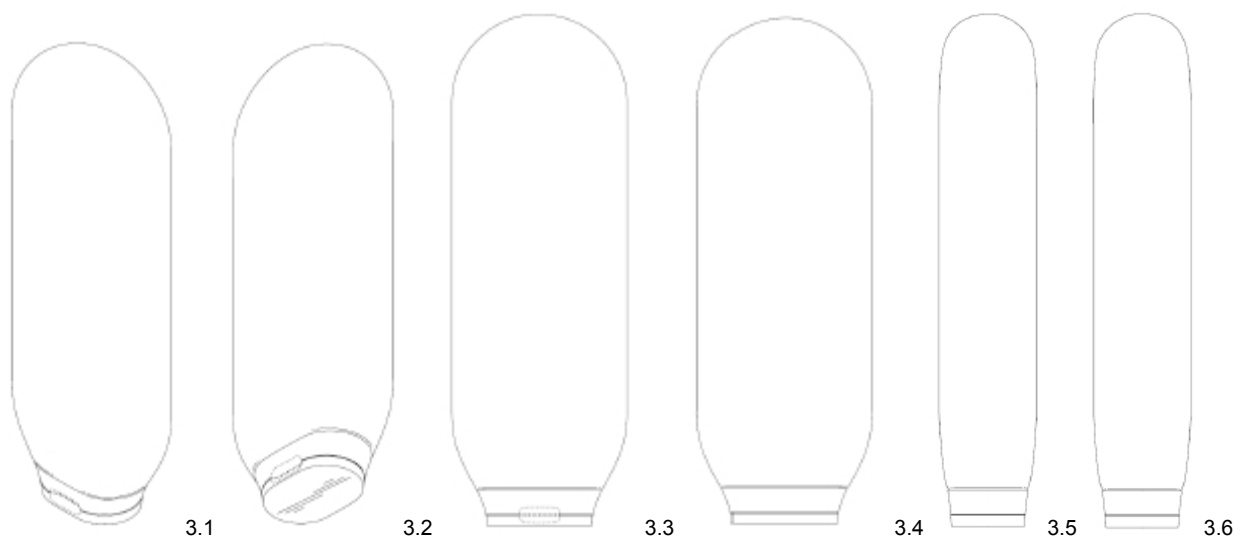

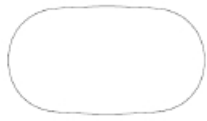

3.7

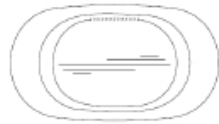

3.8