

Norsk

design tidende

www.patentstyret.no

Norsk designtidende er en publikasjon som inneholder kunngjøringer innenfor designområdet

BESØKSADRESSE

- ▶ Sandakerveien 64

POSTADRESSE

- ▶ Postboks 4863 Nydalen
0422 Oslo

E-POST

- ▶ post@patentstyret.no

TELEFON

- ▶ +47 22 38 73 00
8.00-15.45

Innholdsfortegnelse:

Meddelelse til søker/innehaver med ukjent adresse	3
Registrerte design	4
Internasjonale designregistreringer	42
Fornyelse av registreringer	295
Endringer i fullmaktsforhold	299
Slettede, utgåtte og opphørte nasjonale designregistreringer.....	300
Slettede, utgåtte og opphørte internasjonale designregistreringer.....	301

INID-koder

I kunngjøringene er de enkelte data forsynt med koder overensstemmende med INID-kodesystemet

(INID= Internationally agreed Numbers for the Identification of Data).

- (11) Registreringsnummer
- (15) Registreringsdato
- (18) Dato som registreringen gjelder til
- (21) Søknadsnummer
- (22) Inngivelsesdato
- (24) Løpedag
- (30) Prioritetsopplysninger
- (43) Allment tilgjengelig dato
- (51) Klasse
- (54) Produkt
- (55) Avbildning(er)
- (72) Designer
- (73) Innehaver
- (74) Fullmektig

Meddelelse til søker/innehaver med ukjent adresse

Meddelelse til innehaver av designregistrering nr. 083906, 083895, 083896, Vigdis Antonie Olausen.
Det foreligger avgjørelse om opphør på grunn av ikke betalt fornyelsesavgift i designregistrering nr. 083906, 083895, 083896.
Avgjørelsen kan fås hos Patentstyret.

Registrerte design

I henhold til designloven § 18 første ledd i.f. kunngjøres i dag følgende registrerte design.

Det kan fremsettes krav om at designregistreringen helt eller delvis skal oppheves, jf. designloven §§ 25 flg. og designforskriften §§ 26 flg.

Designregistreringen gjelder for den eller de periodene på fem år som søknaden er innlevert for, regnet fra søknadsdagen. Registreringen kan fornyes, jf. designloven §§ 23 og 24. Maksimal beskyttelsestid er 25 år. For reservedeler, se unntaket i designloven § 23 annet ledd.

(11)	Reg.nr.:	085943
(21)	Søkn.nr.:	20180259
(22)	Inngitt:	2018.03.14
(24)	Løpedag:	2018.03.14
(43)	Allm. tilgj.:	2018.06.18
(15)	Registrert:	2018.06.18
(45)	Kunngjort:	2018.07.16
(18)	Reg. gjelder til:	2023.03.14
(73)	Innehaver:	TINDE AS, Holskogveien 48, 4624 KRISTIANSAND S, Norge
(50)	Anmerkninger:	Registreringen gjelder samregistrering.

Design 1

(54)	Produkt:	Knagg
(51)	Klasse:	08-08
(72)	Designer:	TINDE AS, Holskogveien 48, 4624 KRISTIANSAND S
(55)	Designavbildninger:	

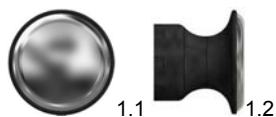

Design 2

(54)	Produkt:	Knagg
(51)	Klasse:	08-08
(72)	Designer:	TINDE AS, Holskogveien 48, 4624 KRISTIANSAND S
(55)	Designavbildninger:	



Design 3

(54)	Produkt:	Del til knaggrekke
(51)	Klasse:	08-08
(72)	Designer:	TINDE AS, Holskogveien 48, 4624 KRISTIANSAND S
(55)	Designavbildninger:	

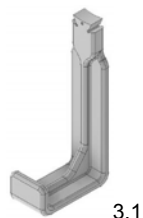

Design 4

- (54) **Produkt:** Knaggrekke
(51) **Klasse:** 08-08
(72) **Designer:** TINDE AS, Holskogveien 48, 4624 KRISTIANSAND S
(55) **Designavbildninger:**

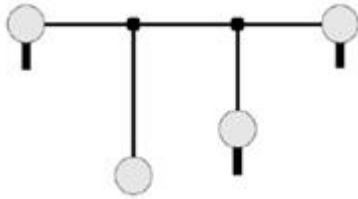

4.1

Design 5

- (54) **Produkt:** Knaggrekke
(51) **Klasse:** 08-08
(72) **Designer:** TINDE AS, Holskogveien 48, 4624 KRISTIANSAND S
(55) **Designavbildninger:**

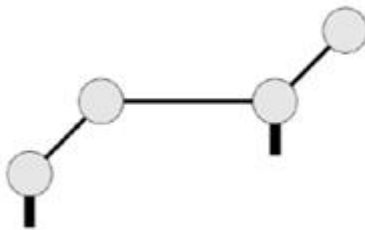

5.1

Design 6

- (54) **Produkt:** Knaggrekke
(51) **Klasse:** 08-08
(72) **Designer:** TINDE AS, Holskogveien 48, 4624 KRISTIANSAND S
(55) **Designavbildninger:**

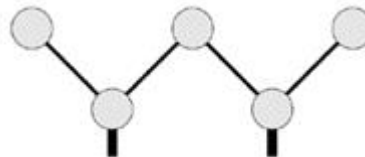

6.1

Design 7

- (54) **Produkt:** Knaggrekke
(51) **Klasse:** 08-08
(72) **Designer:** TINDE AS, Holskogveien 48, 4624 KRISTIANSAND S
(55) **Designavbildninger:**

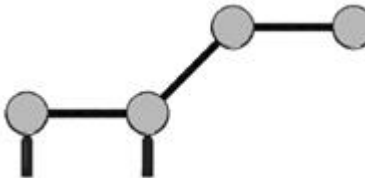

7.1

Design 8

- (54) **Produkt:** Knaggrekke
(51) **Klasse:** 08-08
(72) **Designer:** TINDE AS, Holskogveien 48, 4624 KRISTIANSAND S
(55) **Designavbildninger:**

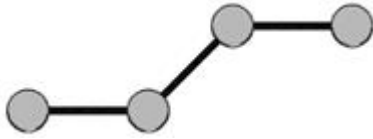

8.1

- (11) **Reg.nr.:** 085944
(21) **Søkn.nr.:** 20180306
(22) **Inngitt:** 2018.03.20
(24) **Løpedag:** 2018.03.20
(43) **Allm. tilgj.:** 2018.06.19
(15) **Registrert:** 2018.06.19
(45) **Kunngjort:** 2018.07.16
(18) **Reg. gjelder til:** 2023.03.20
(73) **Innehaver:** PUREFLAME NORGE AS, Gokstadveien 18, 3216 SANDEFJORD, Norge

Design 1

- (54) **Produkt:** Elektrisk lighter (USB-oppladbar)
(51) **Klasse:** 27-05
(72) **Designer:** PUREFLAME NORGE AS, Gokstadveien 18, 3216 SANDEFJORD
(55) **Designavbildninger:**



1.1

- (11) **Reg.nr.:** 085945
(21) **Søkn.nr.:** 20180491
(22) **Inngitt:** 2018.05.22
(24) **Løpedag:** 2018.05.22
(43) **Allm. tilgj.:** 2018.06.20
(15) **Registrert:** 2018.06.20
(45) **Kunngjort:** 2018.07.16
(18) **Reg. gjelder til:** 2023.05.22
(73) **Innehaver:** BENJAMIN VALAND, 4596 EIKEN, Norge

Design 1

- (54) **Produkt:** Kapsel
(51) **Klasse:** 09-05
(72) **Designer:** BENJAMIN VALAND, 4596 EIKEN
(55) **Designavbildninger:**



- (11) **Reg.nr.:** 085946
(21) **Søkn.nr.:** 20180148
(22) **Inngitt:** 2018.02.15
(24) **Løpedag:** 2018.02.15
(43) **Allm. tilgj.:** 2018.02.16
(15) **Registrert:** 2018.06.20
(45) **Kunngjort:** 2018.07.16
(18) **Reg. gjelder til:** 2023.02.15
(73) **Innehaver:** By Klipklap ApS, Gåseagervej 14, DK-8250 EGÅ, Danmark
(74) **Fullmektig:** Patrade A/S, Ceresbyen 75, DK-8000 AARHUS C, Danmark

Design 1

- (54) **Produkt:** Sittemøbel
(51) **Klasse:** 06-01
(72) **Designer:** Pia Lauritsen, Gåseagervej 14, 8250 EGÅ, Danmark (DK)
(55) **Designavbildninger:**



1.1



1.2

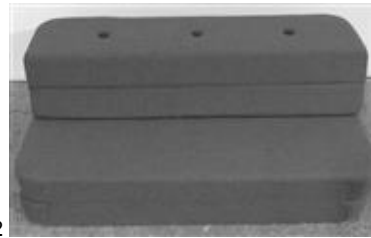

1.3



1.4



1.5

- (11) **Reg.nr.:** 085947
- (21) **Søkn.nr.:** 20180419
- (22) **Inngitt:** 2018.04.27
- (24) **Løpedag:** 2018.04.27
- (43) **Allm. tilgj.:** 2018.04.30
- (15) **Registrert:** 2018.06.21
- (45) **Kunngjort:** 2018.07.16
- (18) **Reg. gjelder til:** 2023.04.27
- (73) **Innehaver:** Dietmar Niederl, Lugitsch 63, AT-8091 JAGERBERG, Østerrike
- (74) **Fullmektig:** OSLO PATENTKONTOR AS, Postboks 7007 M, 0306 OSLO, Norge
- (50) **Anmerkninger:** Registreringen gjelder samregistrering.

Design 1

- (54) **Produkt:** Del til elektrisk kontakt
- (51) **Klasse:** 13-03
- (72) **Designer:** Dietmar Niederl, Lugitsch 63, 8091 JAGERBERG, Østerrike (AT)
- (30) **Prioritet:** 2017.10.31, EM, 004428084, 1, 2
- (55) **Designavbildninger:**

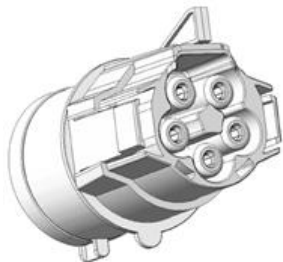

1.1

Design 2

- (54) **Produkt:** Del til elektrisk kontakt
- (51) **Klasse:** 13-03
- (72) **Designer:** Dietmar Niederl, Lugitsch 63, 8091 JAGERBERG, Østerrike (AT)
- (30) **Prioritet:** 2017.10.31, EM, 004428084, 1, 2
- (55) **Designavbildninger:**



2.1

- (11) **Reg.nr.:** 085948
(21) **Søkn.nr.:** 20180357
(22) **Inngitt:** 2018.04.16
(24) **Løpedag:** 2018.04.16
(43) **Allm. tilgj.:** 2018.04.16
(15) **Registrert:** 2018.06.22
(45) **Kunngjort:** 2018.07.16
(18) **Reg. gjelder til:** 2023.04.16
(73) **Innehaver:** VARVINBYGG KÅRE VARVIN, Løvenskioldsvei 15 a, 1358 JAR, Norge

Design 1

- (54) **Produkt:** Skipsskrog
(51) **Klasse:** 12-06
(72) **Designer:** VARVINBYGG KÅRE VARVIN, Løvenskioldsvei 15 a, 1358 JAR
(55) **Designavbildninger:**



1.1

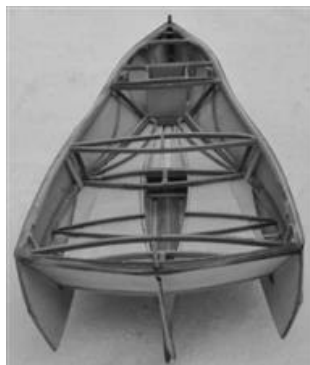

1.2

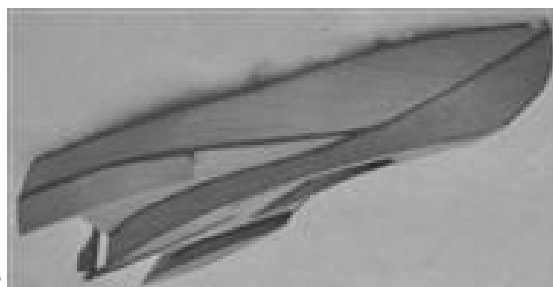

1.3

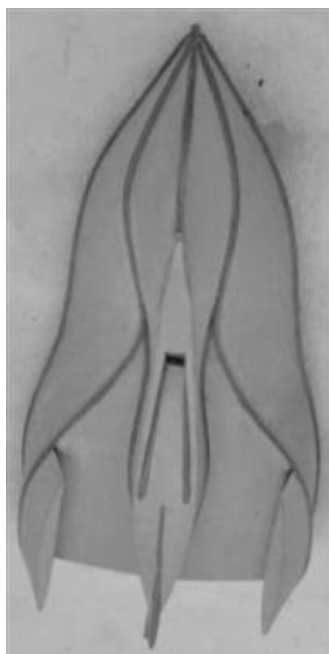

1.4

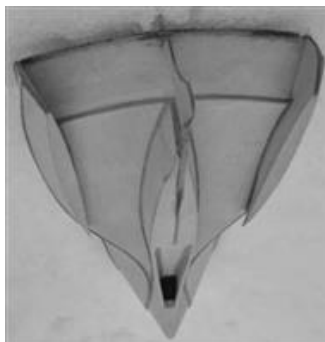

1.5



1.6

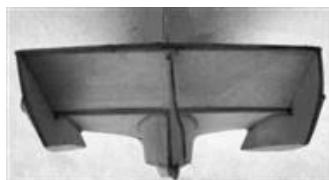

1.7

- (11) **Reg.nr.:** 085949
(21) **Søkn.nr.:** 20180412
(22) **Inngitt:** 2018.04.25
(24) **Løpedag:** 2018.04.25
(43) **Allm. tilgj.:** 2018.04.25
(15) **Registrert:** 2018.06.22
(45) **Kunngjort:** 2018.07.16
(18) **Reg. gjelder til:** 2023.04.25
(73) **Innehaver:** VEGARD MØMB, Østagerenda, 2485 RENDALEN, Norge

Design 1

- (54) **Produkt:** Emballasjeglass for honning
(51) **Klasse:** 09-01
(72) **Designer:** FRONTAL MEDIA AS, Bergmannsgata 11, 7374 RØROS
(55) **Designavbildninger:**



1.1



1.2



1.3

- (11) **Reg.nr.:** 085950
(21) **Søkn.nr.:** 20180410
(22) **Inngitt:** 2018.04.23
(24) **Løpedag:** 2018.04.23
(43) **Allm. tilgj.:** 2018.04.23
(15) **Registrert:** 2018.06.22
(45) **Kunngjort:** 2018.07.16
(18) **Reg. gjelder til:** 2023.04.23
(73) **Innehaver:** HOVIN TREVARE JESSHEIM GLASS SERVICE AS, Krokfossvegen 13, 2067 JESSHEIM, Norge
(74) **Fullmektig:** Andreas Ljones, Grøndalsvegen 274, 2055 NORDKISA, Norge

Design 1

- (54) **Produkt:** Sittebenk
(51) **Klasse:** 06-01
(72) **Designer:** Andreas Ljones, Grøndalsvegen 274, 2055 NORDKISA
(55) **Designavbildninger:**



- (11) **Reg.nr.:** 085951
(21) **Søkn.nr.:** 20180418
(22) **Inngitt:** 2018.04.26
(24) **Løpedag:** 2018.04.26
(43) **Allm. tilgj.:** 2018.04.26
(15) **Registrert:** 2018.06.22
(45) **Kunngjort:** 2018.07.16
(18) **Reg. gjelder til:** 2023.04.26
(73) **Innehaver:** Stiftelsen Erlik, Skippergata 14, 0152 OSLO, Norge
(74) **Fullmektig:** BRYN AARFLOT AS, Stortingsgata 8, 0161 OSLO, Norge
(50) **Anmerkninger:** Registreringen gjelder samregistrering.

Design 1

- (54) **Produkt:** Logo
(51) **Klasse:** 32-00
(72) **Designer:** Stiftelsen Erlik, Skippergata 14, 0152 OSLO
(55) **Designavbildninger:**



1.1

Design 2

- (54) **Produkt:** Logo
(51) **Klasse:** 32-00
(72) **Designer:** Stiftelsen Erlik, Skippergata 14, 0152 OSLO
(55) **Designavbildninger:**

**OSLO**

2.1

Design 3

- (54) **Produkt:** Logo
(51) **Klasse:** 32-00
(72) **Designer:** Stiftelsen Erlik, Skippergata 14, 0152 OSLO
(55) **Designavbildninger:**

**NORGE**

3.1

Design 4

- (54) **Produkt:** Logo
(51) **Klasse:** 32-00
(72) **Designer:** Stiftelsen Erlik, Skippergata 14, 0152 OSLO
(55) **Designavbildninger:**



KAFFE

4.1

- (11) **Reg.nr.:** 085952
(21) **Søkn.nr.:** 20171073
(22) **Inngitt:** 2017.11.16
(24) **Løpedag:** 2017.11.16
(43) **Allm. tilgj.:** 2018.03.27
(15) **Registrert:** 2018.06.22
(45) **Kunngjort:** 2018.07.16
(18) **Reg. gjelder til:** 2022.11.16
(73) **Innehaver:** STAYCLASSY AS, Ola Valdris vei 10, 1357 BEKKESTUA, Norge
(50) **Anmerkninger:** Registreringen gjelder samregistrering.

Design 1

- (54) **Produkt:** Ståhjuling
(51) **Klasse:** 12-11
(72) **Designer:** STAYCLASSY AS, Ola Valdris vei 10, 1357 BEKKESTUA
(55) **Designavbildninger:**

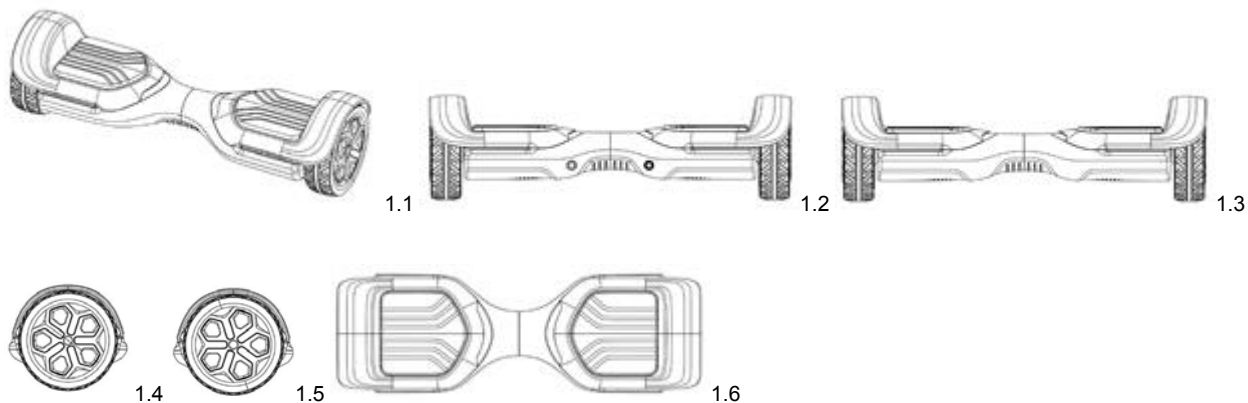
**Design 2**

- (54) **Produkt:** Ståhjuling
(51) **Klasse:**
(72) **Designer:** STAYCLASSY AS, Ola Valdris vei 10, 1357 BEKKESTUA
(55) **Designavbildninger:**



- (11) **Reg.nr.:** 085953
(21) **Søkn.nr.:** 20180122
(22) **Inngitt:** 2018.02.07
(24) **Løpedag:** 2018.02.07
(43) **Allm. tilgj.:** 2018.02.08
(15) **Registrert:** 2018.06.25
(45) **Kunngjort:** 2018.07.16
(18) **Reg. gjelder til:** 2023.02.07
(73) **Innehaver:** Raytheon Canada Ltd., 360 Albert Street, Suite 1640, CA-ONK1R7X7 OTTAWA, Canada
(74) **Fullmektig:** CURO AS, Vestre Rosten 81, 7075 TILLER, Norge
(50) **Anmerkninger:** Registreringen gjelder samregistrering.

Design 1

- (54) **Produkt:** Ornement
(51) **Klasse:** 32-00
(72) **Designer:** Brien D. Ross, 18 Dorcas Avenue, ONL0L2T0 WYEVALE, Canada (CA)
Ryan Nobes, 4971 County Road 9, ONL0M1N0 NEW LOWELL, Canada (CA)
Kevin B. Wagner, 45 Mary Jane Road, ONL0L2T0 WYEVALE, Canada (CA)
(30) **Prioritet:** 2017.08.08, US, 29/613,190, 1, 2, 3, 4, 5, 6
(55) **Designavbildninger:**



1.1

Design 2

- (54) **Produkt:** Ornement
(51) **Klasse:** 32-00
(72) **Designer:** Brien D. Ross, 18 Dorcas Avenue, ONL0L2T0 WYEVALE, Canada (CA)
Ryan Nobes, 4971 County Road 9, ONL0M1N0 NEW LOWELL, Canada (CA)
Kevin B. Wagner, 45 Mary Jane Road, ONL0L2T0 WYEVALE, Canada (CA)
(30) **Prioritet:** 2017.08.08, US, 29/613,190, 1, 2, 3, 4, 5, 6
(55) **Designavbildninger:**



2.1

Design 3

- (54) **Produkt:** Ornement
(51) **Klasse:** 32-00
(72) **Designer:** Brien D. Ross, 18 Dorcas Avenue, ONL0L2T0 WYEVALE, Canada (CA)
Ryan Nobes, 4971 County Road 9, ONL0M1N0 NEW LOWELL, Canada (CA)
Kevin B. Wagner, 45 Mary Jane Road, ONL0L2T0 WYEVALE, Canada (CA)
(30) **Prioritet:** 2017.08.08, US, 29/613,190, 1, 2, 3, 4, 5, 6
(55) **Designavbildninger:**

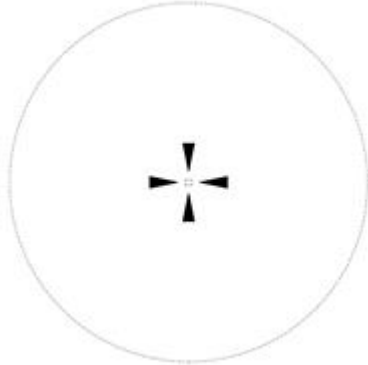

3.1

Design 4

- (54) **Produkt:** Ornement
(51) **Klasse:** 32-00
(72) **Designer:** Brien D. Ross, 18 Dorcas Avenue, ONL0L2T0 WYEVALE, Canada (CA)
Ryan Nobes, 4971 County Road 9, ONL0M1N0 NEW LOWELL, Canada (CA)
Kevin B. Wagner, 45 Mary Jane Road, ONL0L2T0 WYEVALE, Canada (CA)
(30) **Prioritet:** 2017.08.08, US, 29/613,190, 1, 2, 3, 4, 5, 6
(55) **Designavbildninger:**

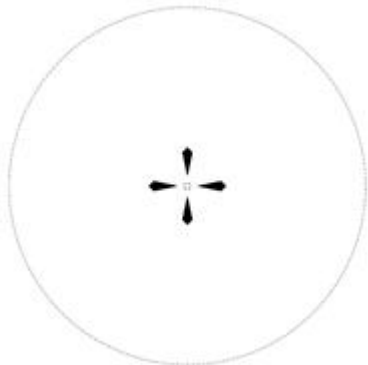

4.1

Design 5

- (54) **Produkt:** Ornement
(51) **Klasse:** 32-00
(72) **Designer:** Brien D. Ross, 18 Dorcas Avenue, ONL0L2T0 WYEVALE, Canada (CA)
Ryan Nobes, 4971 County Road 9, ONL0M1N0 NEW LOWELL, Canada (CA)
Kevin B. Wagner, 45 Mary Jane Road, ONL0L2T0 WYEVALE, Canada (CA)
(30) **Prioritet:** 2017.08.08, US, 29/613,190, 1, 2, 3, 4, 5, 6
(55) **Designavbildninger:**



5.1

Design 6

- (54) **Produkt:** Ornamment
(51) **Klasse:** 32-00
(72) **Designer:** Brien D. Ross, 18 Dorcas Avenue, ONL0L2T0 WYEVALE, Canada (CA)
Ryan Nobes, 4971 County Road 9, ONL0M1N0 NEW LOWELL, Canada (CA)
Kevin B. Wagner, 45 Mary Jane Road, ONL0L2T0 WYEVALE, Canada (CA)
(30) **Prioritet:** 2017.08.08, US, 29/613,190, 1, 2, 3, 4, 5, 6
(55) **Designavbildninger:**

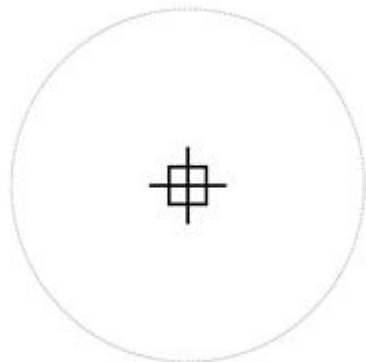

6.1

(11)	Reg.nr.:	085954
(21)	Søkn.nr.:	20180317
(22)	Inngitt:	2018.03.22
(24)	Løpedag:	2018.03.22
(43)	Allm. tilgj.:	2018.06.25
(15)	Registrert:	2018.06.25
(45)	Kunngjort:	2018.07.16
(18)	Reg. gjelder til:	2023.03.22
(73)	Innehaver:	Tengu Fitness AS, Hyllebærstien 18, 1405 LANGHUS, Norge
(74)	Fullmektig:	ATTORNEY ANGELICA COPPINI, c/o Trademack-Formir, Spinola Road 137, MT-STJ3011 ST. JULIANS, Malta

Design 1

(54)	Produkt:	Grafisk symbol
(51)	Klasse:	32-00
(72)	Designer:	Tengu Fitness AS, Hyllebærstien 18, 1405 LANGHUS
(50)	Anmerkning:	Designet er i farger.
(55)	Designavbildninger:	

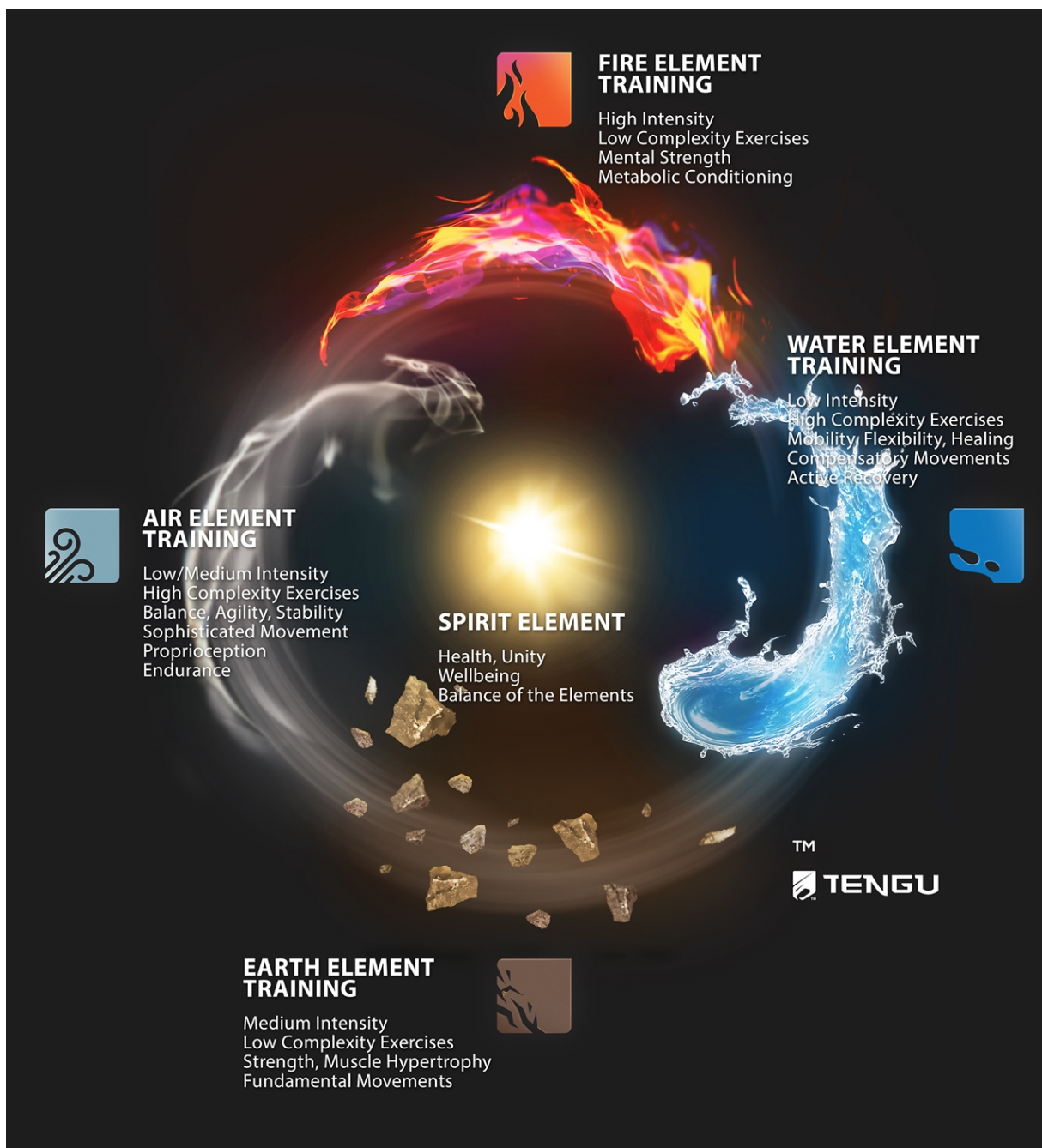

1.1

- (11) **Reg.nr.:** 085955
(21) **Søkn.nr.:** 20180446
(22) **Inngitt:** 2018.05.08
(24) **Løpedag:** 2018.05.08
(43) **Allm. tilgj.:** 2018.06.25
(15) **Registrert:** 2018.06.25
(45) **Kunngjort:** 2018.07.16
(18) **Reg. gjelder til:** 2023.05.08
(73) **Innehaver:** Shanghai Sincere Home Design Co. Ltd., Building No #4, 509 Street, Ren Qing RD, CN-P.C.201201 PU DONG, SHANGHAI, Kina
(74) **Fullmektig:** Otello Law firm, Dalgasgade 25, 8., DK-7400 HERNING, Danmark

Design 1

- (54) **Produkt:** Glassvare til pynt
(51) **Klasse:** 11-02
(72) **Designer:** Lisa Markfoged, Hyrdehøj Bygade 262, 4000 ROSKILDE, Danmark (DK)
(50) **Anmerkning:** Designet er i farger.
(55) **Designavbildninger:**



1.1



1.2



1.3



1.4



1.5



1.6



1.7

Design 2

- (54) **Produkt:** Glassvare til pynt
(51) **Klasse:** 11-02
(72) **Designer:** Lisa Markfoged, Hyrdehøj Bygade 262, 4000 ROSKILDE, Danmark (DK)
(50) **Anmerkning:** Designet er i farger.
(55) **Designavbildninger:**



2.1



2.2



2.3



2.4



2.5



2.6



2.7

Design 3

- (54) **Produkt:** Glassvare til pynt
(51) **Klasse:** 11-02
(72) **Designer:** Lisa Markfoged, Hyrdehøj Bygade 262, 4000 ROSKILDE, Danmark (DK)
(50) **Anmerkning:** Designet er i farger.
(55) **Designavbildninger:**



3.1



3.2

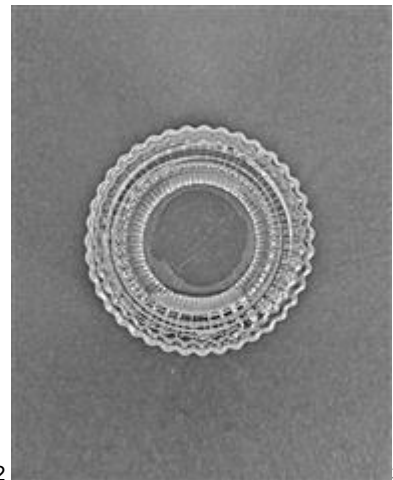

3.3



3.4



3.5



3.6

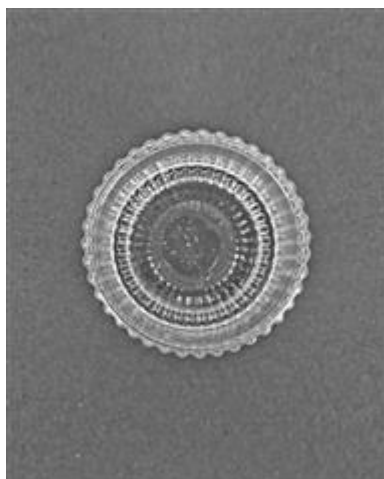

3.7

Design 4

- (54) **Produkt:** Glassvare til pynt
(51) **Klasse:** 11-02
(72) **Designer:** Lisa Markfoged, Hyrdehøj Bygade 262, 4000 ROSKILDE, Danmark (DK)
(50) **Anmerkning:** Designet er i farger.
(55) **Designavbildninger:**



4.1



4.2



4.3



4.4



4.5



4.6



4.7

Design 5

- (54) **Produkt:** Glassvare til pynt
(51) **Klasse:** 11-02
(72) **Designer:** Lisa Markfoged, Hyrdehøj Bygade 262, 4000 ROSKILDE, Danmark (DK)
(50) **Anmerkning:** Designet er i farger.
(55) **Designavbildninger:**



5.1



5.2



5.3



5.4



5.5



5.6



5.7

Design 6

- (54) **Produkt:** Glassvare til pynt
(51) **Klasse:** 11-02
(72) **Designer:** Lisa Markfoged, Hyrdehøj Bygade 262, 4000 ROSKILDE, Danmark (DK)
(50) **Anmerkning:** Designet er i farger.
(55) **Designavbildninger:**

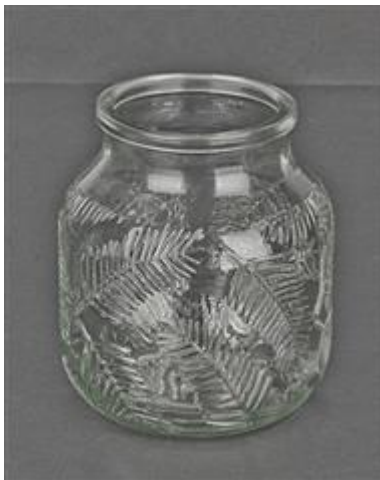

6.1



6.2



6.3



6.4



6.5



6.6



6.7

Design 7

- (54) **Produkt:** Glassvare til pynt
(51) **Klasse:** 11-02
(72) **Designer:** Lisa Markfoged, Hyrdehøj Bygade 262, 4000 ROSKILDE, Danmark (DK)
(50) **Anmerkning:** Designet er i farger.
(55) **Designavbildninger:**



7.1



7.2



7.3



7.4



7.5

Design 8

- (54) **Produkt:** Glassvare til pynt
(51) **Klasse:** 11-02
(72) **Designer:** Lisa Markfoged, Hyrdehøj Bygade 262, 4000 ROSKILDE, Danmark (DK)
(50) **Anmerkning:** Designet er i farger.
(55) **Designavbildninger:**



8.1



8.2



8.3



8.4



8.5



8.6



8.7

Design 9

- (54) **Produkt:** Glassvare til pynt
(51) **Klasse:** 11-02
(72) **Designer:** Lisa Markfoged, Hyrdehøj Bygade 262, 4000 ROSKILDE, Danmark (DK)
(50) **Anmerkning:** Designet er i farger.
(55) **Designavbildninger:**



9.1



9.2



9.3



9.4



9.5



9.6

Design 10

- (54) **Produkt:** Glassvare til pynt
(51) **Klasse:** 11-02
(72) **Designer:** Lisa Markfoged, Hyrdehøj Bygade 262, 4000 ROSKILDE, Danmark (DK)
(50) **Anmerkning:** Designet er i farger.
(55) **Designavbildninger:**



10.1



10.2



10.3



10.4



10.5



10.6



10.7

- (11) **Reg.nr.:** 085956
 (21) **Søkn.nr.:** 20180445
 (22) **Inngitt:** 2018.05.09
 (24) **Løpedag:** 2018.05.09
 (43) **Allm. tilgj.:** 2018.05.29
 (15) **Registrert:** 2018.06.25
 (45) **Kunngjort:** 2018.07.16
 (18) **Reg. gjelder til:** 2023.05.09
 (73) **Innehaver:** Västsvensk Byggskruv AB, Vävlagargatan 5, SE-50730 BRÄMHULT, Sverige
 (74) **Fullmektig:** CURO AS, Vestre Rosten 81, 7075 TILLER, Norge
 (50) **Anmerkninger:** Registreringen gjelder samregistrering.

Design 1

- (54) **Produkt:** Emballasje
 (51) **Klasse:** 09-03
 (72) **Designer:** Christian Forsström, Viltstigen 13, 51841 SJÖMARKEN, Sverige (SE)
 (30) **Prioritet:** 2017.11.29, EM, 004527505
 (55) **Designavbildninger:**

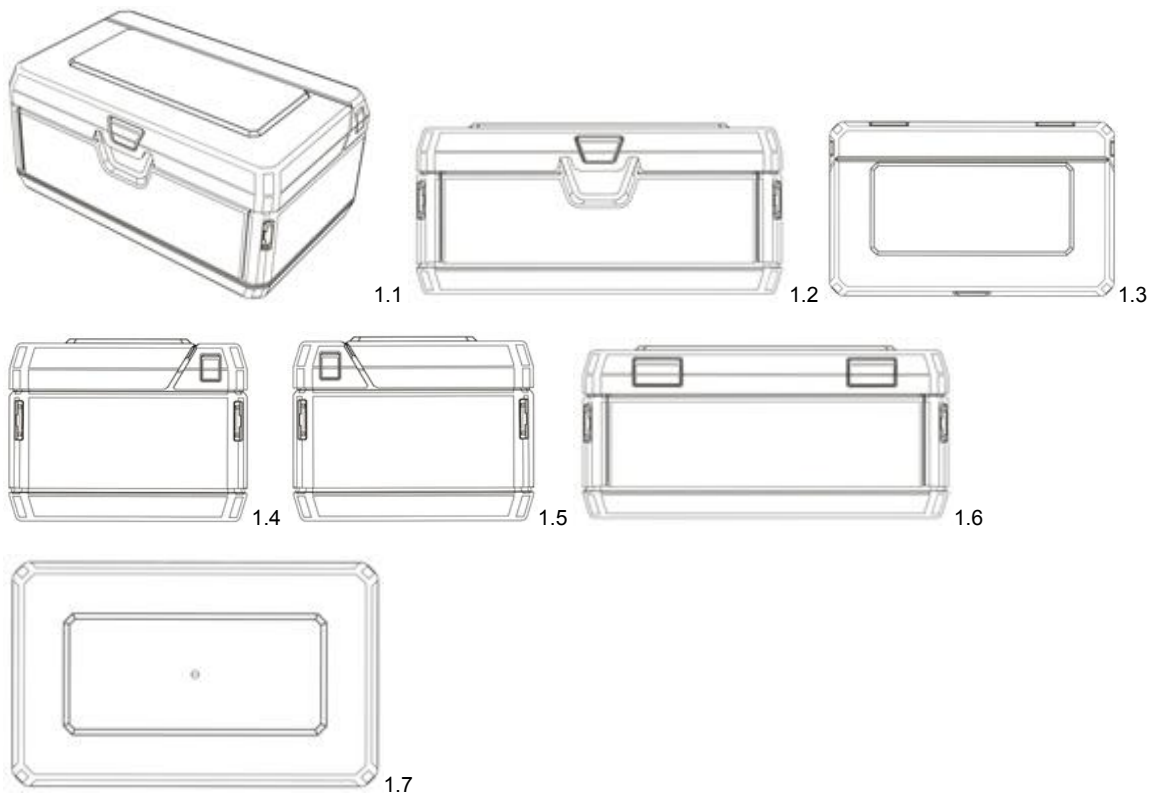
**Design 2**

- (54) **Produkt:** Emballasje
 (51) **Klasse:** 09-03
 (72) **Designer:** Christian Forsström, Viltstigen 13, 51841 SJÖMARKEN, Sverige (SE)
 (30) **Prioritet:** 2017.11.29, EM, 004527505
 (55) **Designavbildninger:**

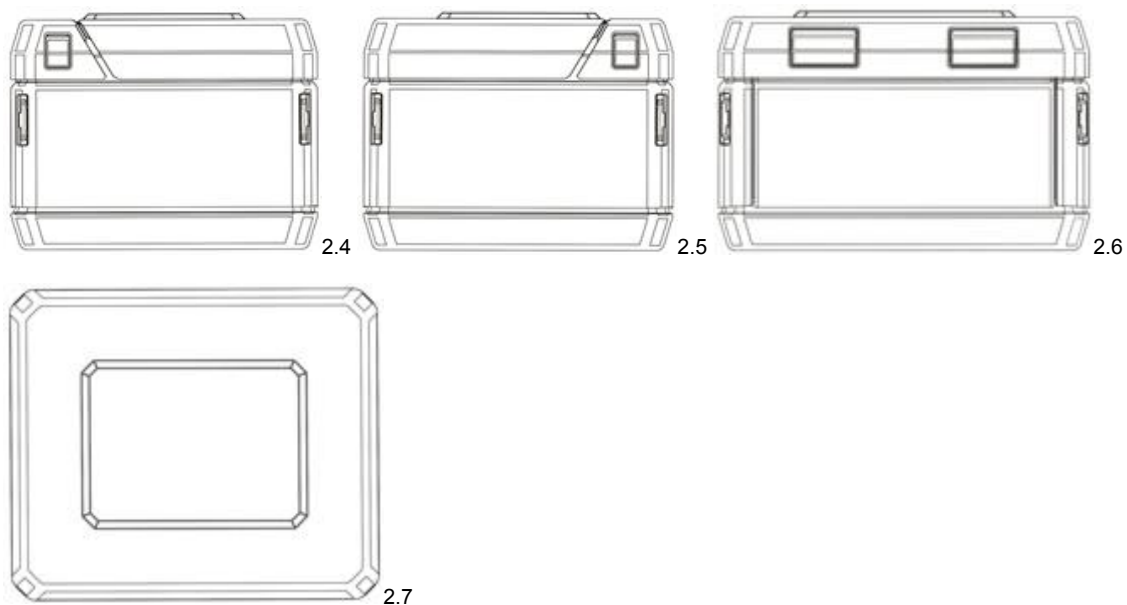

**Design 3**

- (54) **Produkt:** Emballasje
 (51) **Klasse:** 09-03
 (72) **Designer:** Christian Forsström, Viltstigen 13, 51841 SJÖMARKEN, Sverige (SE)
 (30) **Prioritet:** 2017.11.29, EM, 004527505
 (55) **Designavbildninger:**

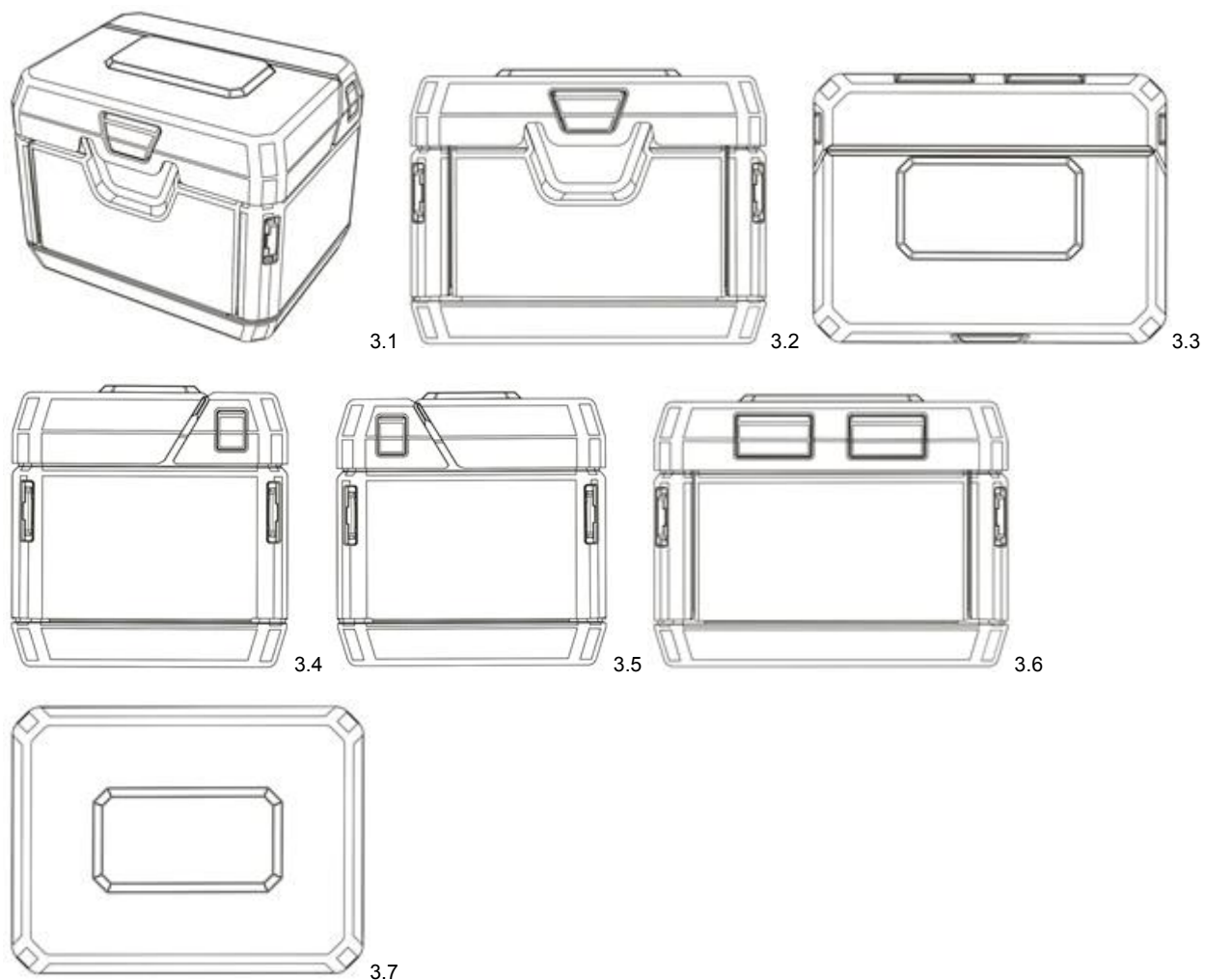

- (11) **Reg.nr.:** 085957
(21) **Søkn.nr.:** 20180455
(22) **Inngitt:** 2018.05.11
(24) **Løpedag:** 2018.05.11
(43) **Allm. tilgj.:** 2018.05.13
(15) **Registrert:** 2018.06.26
(45) **Kunngjort:** 2018.07.16
(18) **Reg. gjelder til:** 2023.05.11
(73) **Innehaver:** Robert Bosch GmbH, Postfach 30 02 20, DE-70442 STUTTGART, Tyskland
(74) **Fullmektig:** ZACCO NORWAY AS, Postboks 2003 Vika, 0125 OSLO, Norge
(50) **Anmerkninger:** Registreringen gjelder samregistrering.

Design 1

- (54) **Produkt:** Trykkmåler for dekk
(51) **Klasse:** 10-04
(72) **Designer:** Matthias Ludwig, Krokusweg 12, 72116 MOESSINGEN, Tyskland (DE)
(30) **Prioritet:** 2017.11.13, EM, 004504082, 1, 2, 3, 4
(55) **Designavbildninger:**

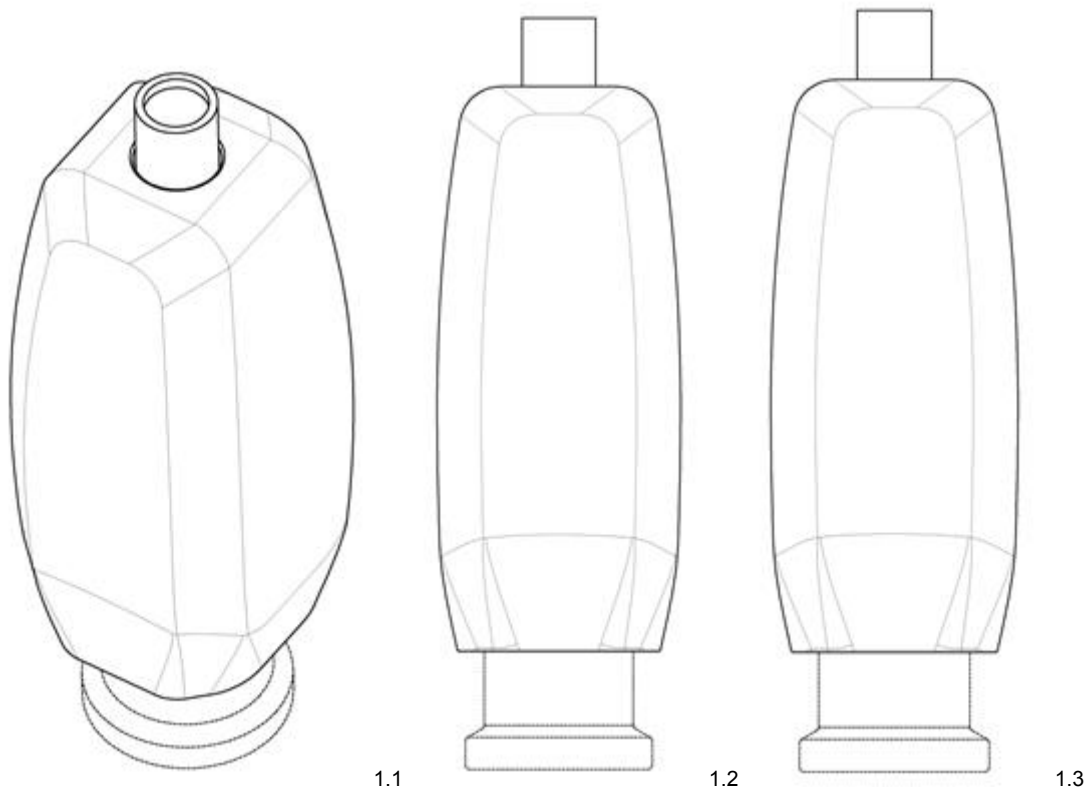

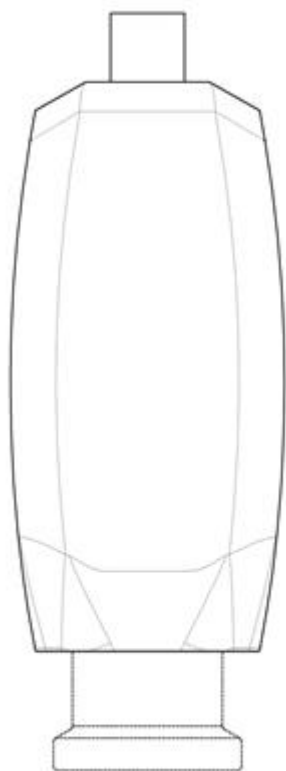

1.4

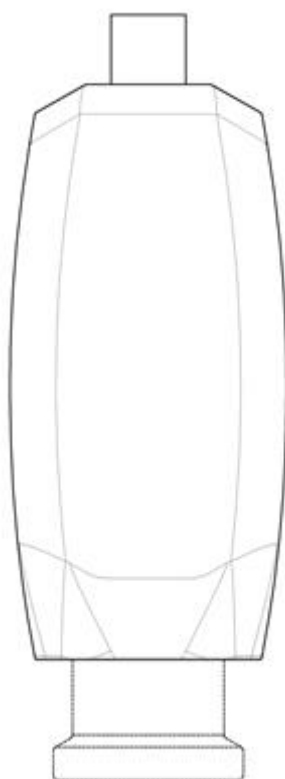

1.5

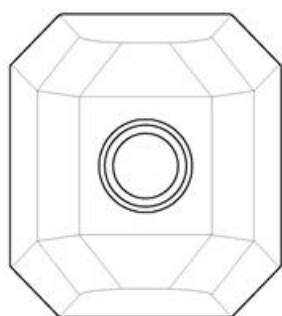

1.6

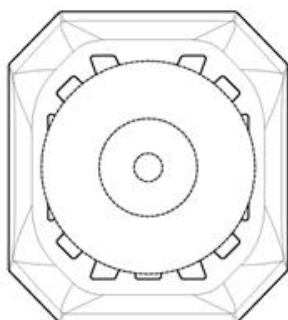

1.7

Design 2

- (54) **Produkt:** Trykkmåler for dekk
(51) **Klasse:** 10-04
(72) **Designer:** Matthias Ludwig, Krokusweg 12, 72116 MOESSINGEN, Tyskland (DE)
(30) **Prioritet:** 2017.11.13, EM, 004504082, 1, 2, 3, 4
(55) **Designavbildninger:**

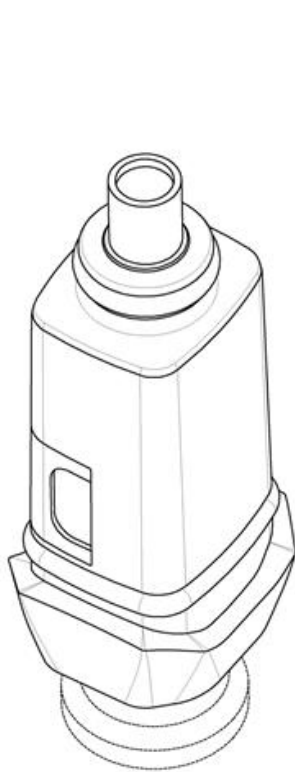

2.1

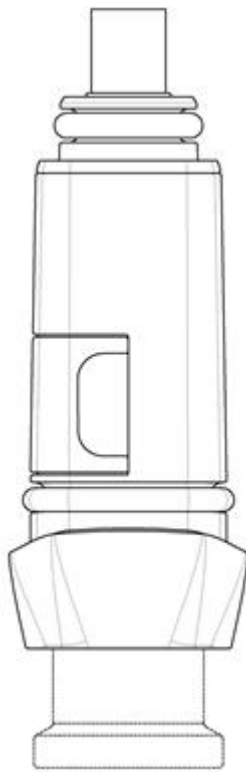

2.2

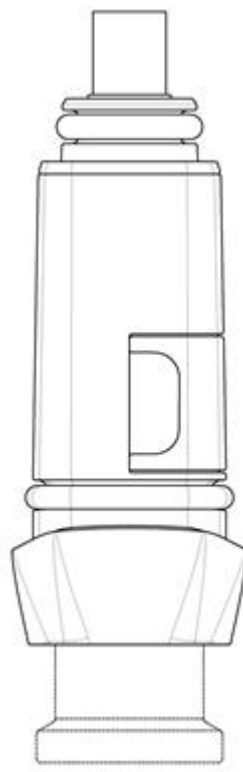

2.3

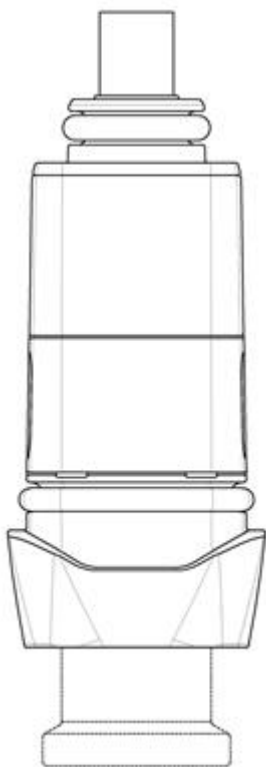

2.4

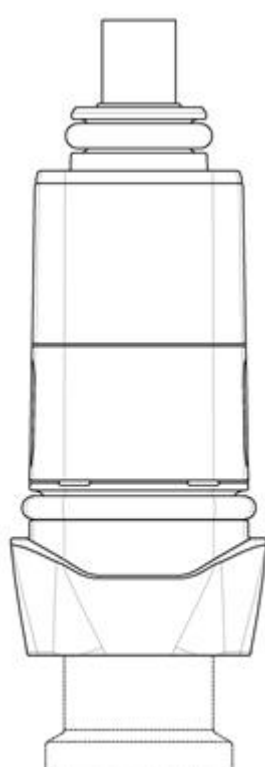

2.5

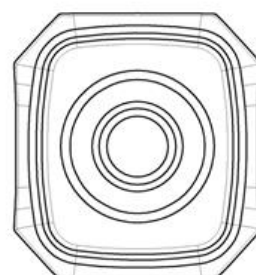

2.6

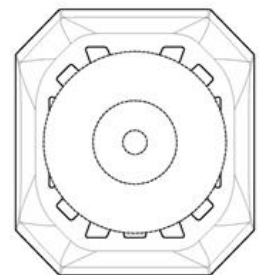

2.7

Design 3

- (54) **Produkt:** Trykkmåler for dekk
(51) **Klasse:** 10-04
(72) **Designer:** Matthias Ludwig, Krokusweg 12, 72116 MOESSINGEN, Tyskland (DE)
(30) **Prioritet:** 2017.11.13, EM, 004504082, 1, 2, 3, 4
(55) **Designavbildninger:**



3.1



3.2



3.3

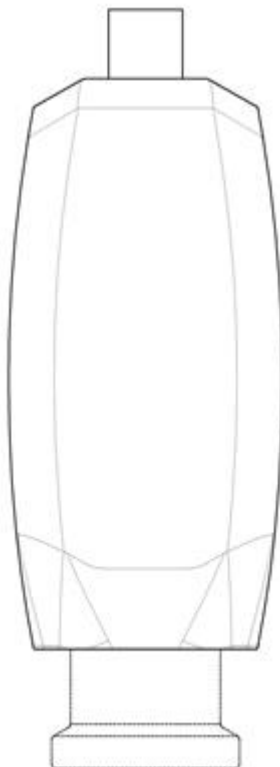

3.4

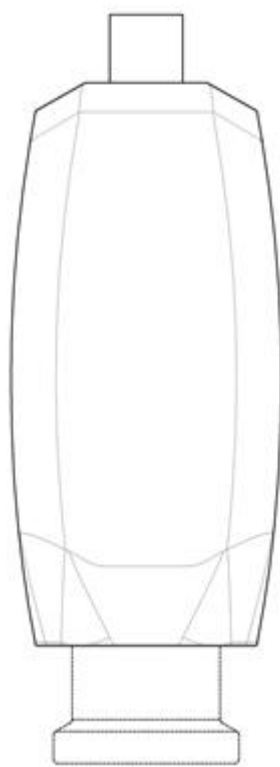

3.5

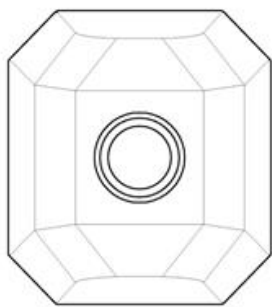

3.6

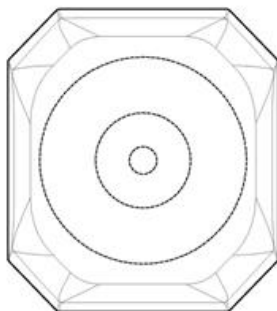

3.7

Design 4

- (54) **Produkt:** Trykkmåler for dekk
(51) **Klasse:** 10-04
(72) **Designer:** Matthias Ludwig, Krokusweg 12, 72116 MOESSINGEN, Tyskland (DE)
(30) **Prioritet:** 2017.11.13, EM, 004504082, 1, 2, 3, 4
(55) **Designavbildninger:**

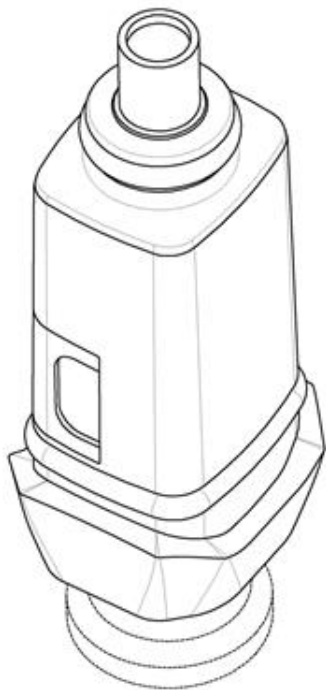

4.1

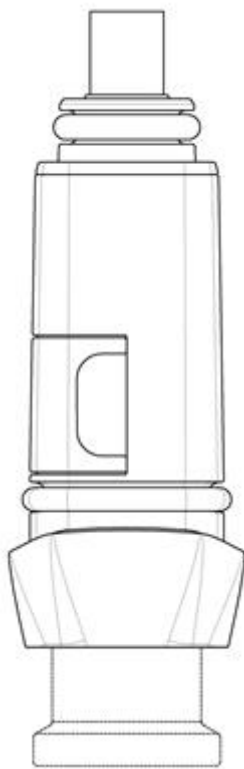

4.2

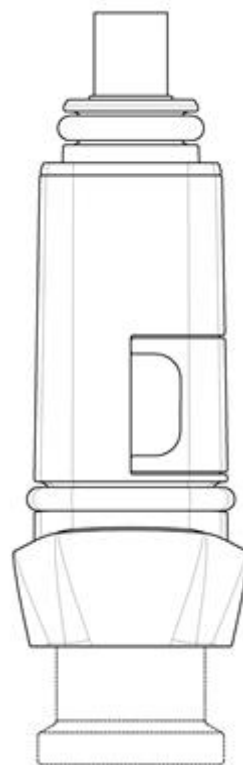

4.3

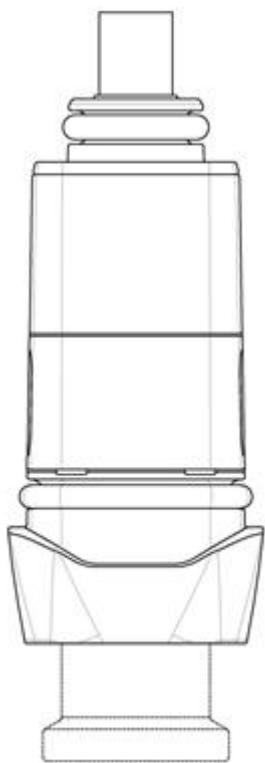

4.4



4.5

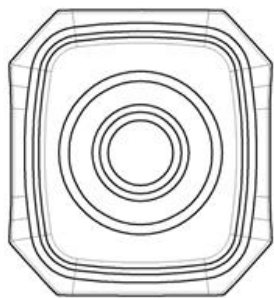

4.6

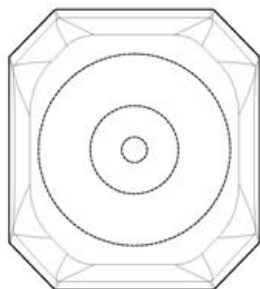

4.7

- (11) **Reg.nr.:** 085958
(21) **Søkn.nr.:** 20180457
(22) **Inngitt:** 2018.05.12
(24) **Løpedag:** 2018.05.12
(43) **Allm. tilgj.:** 2018.06.28
(15) **Registrert:** 2018.06.28
(45) **Kunngjort:** 2018.07.16
(18) **Reg. gjelder til:** 2023.05.12
(73) **Innehaver:** Svein Rune Loeng, Nedre Stibakken 22, 7562 SAKSVIK, Norge
(50) **Anmerkninger:** Registreringen gjelder samregistrering.

Design 1

- (54) **Produkt:** Fingerring
(51) **Klasse:** 11-01
(72) **Designer:** Svein Rune Loeng, Nedre Stibakken 22, 7562 SAKSVIK
(55) **Designavbildninger:**

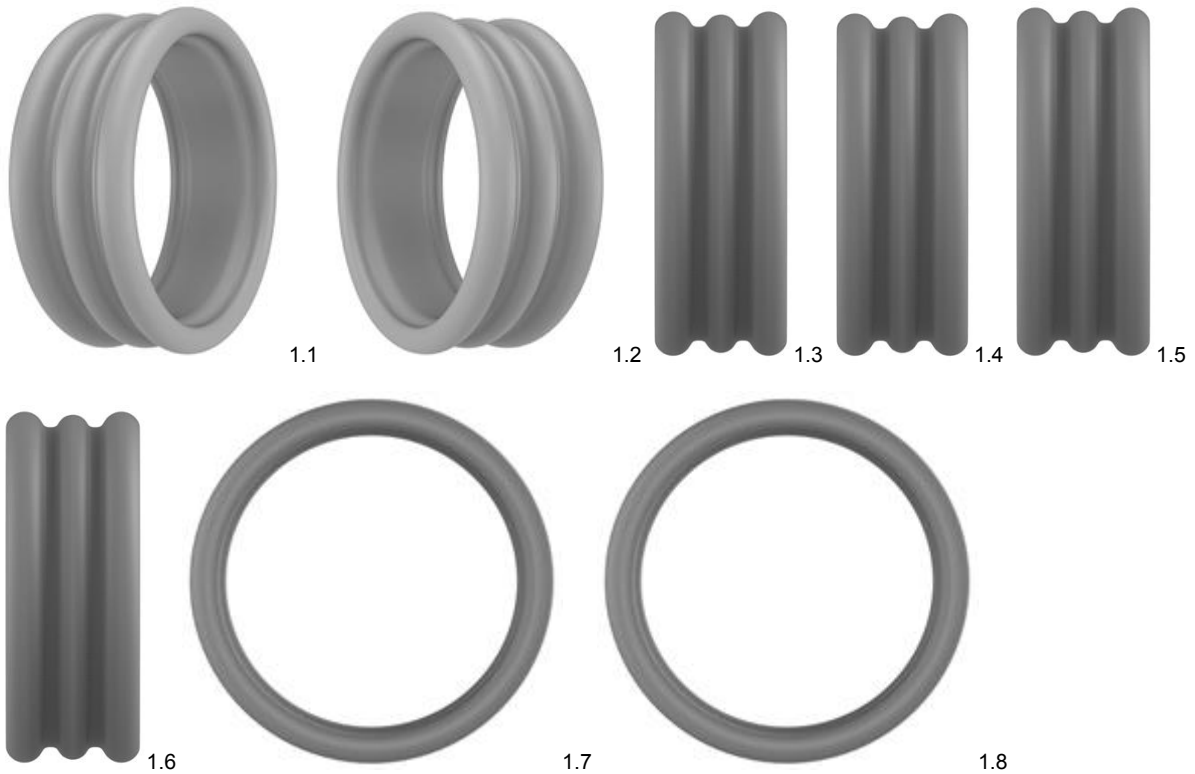
**Design 2**

- (54) **Produkt:** Fingerring
(51) **Klasse:** 11-01
(72) **Designer:** Svein Rune Loeng, Nedre Stibakken 22, 7562 SAKSVIK
(55) **Designavbildninger:**

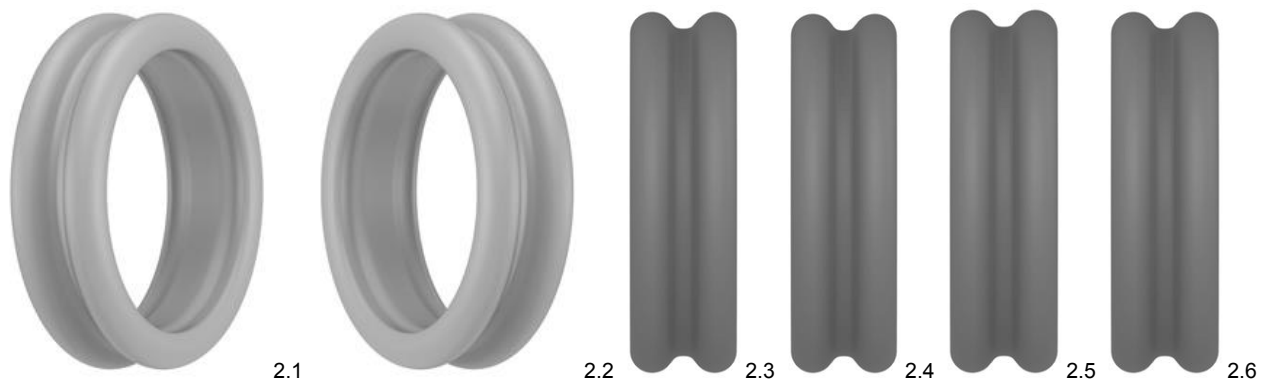



2.7



2.8

- (11) **Reg.nr.:** 085959
 (21) **Søkn.nr.:** 20180330
 (22) **Inngitt:** 2018.04.04
 (24) **Løpedag:** 2018.04.04
 (43) **Allm. tilgj.:** 2018.04.16
 (15) **Registrert:** 2018.06.28
 (45) **Kunngjort:** 2018.07.16
 (18) **Reg. gjelder til:** 2023.04.04
 (73) **Innehaver:** PLEWA Schornstein Technik und HeizSysteme GmbH, Tongrubenstr. 10, DE-92421 SCHWANDORF-KLARDORF, Tyskland
 (74) **Fullmektig:** PROTECTOR INTELLECTUAL PROPERTY CONSULTANTS AS, Oscars gate 20, 0352 OSLO, Norge
 (50) **Anmerkninger:** Registreringen gjelder samregistrering.

Design 1

- (54) **Produkt:** Ovn
 (51) **Klasse:** 23-03
 (72) **Designer:** Eugen Hennig, Brühlstrasse 17, 54636 SEFFERN, Tyskland (DE)
 (30) **Prioritet:** 2017.10.16, EM, 004407609, 1, 2, 3
 (50) **Anmerking:** Designet er i farger.
 (55) **Designavbildninger:**



1.1

Design 2

- (54) **Produkt:** Ovn
 (51) **Klasse:** 23-03
 (72) **Designer:** Eugen Hennig, Brühlstrasse 17, 54636 SEFFERN, Tyskland (DE)
 (30) **Prioritet:** 2017.10.16, EM, 004407609, 1, 2, 3
 (50) **Anmerking:** Designet er i farger.
 (55) **Designavbildninger:**



2.1



2.2



2.3



2.4



2.5



2.6

Design 3

- (54) **Produkt:** Ovn
(51) **Klasse:** 23-03
(72) **Designer:** Eugen Hennig, Brühlstrasse 17, 54636 SEFFERN, Tyskland (DE)
(30) **Prioritet:** 2017.10.16, EM, 004407609, 1, 2, 3
(55) **Designavbildninger:**

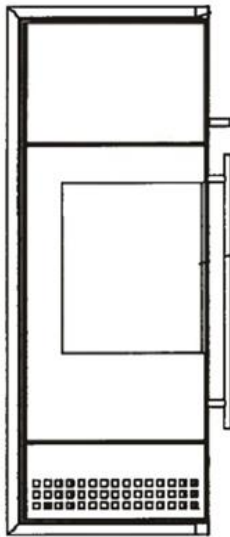

3.1

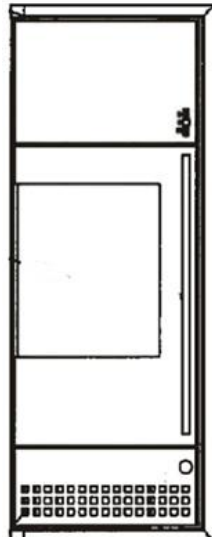

3.2

Internasjonale designregistreringer

I henhold til designloven § 57 fjerde ledd, kunngjøres i dag følgende internasjonale registreringer som har virkning i Norge.

Det kan fremsettes krav om at designregistreringen helt eller delvis skal oppheves, jf. designloven §§ 58 fjerde ledd og 25 flg. og designforskriften §§ 26 flg.

Virkningen av en internasjonal registrering gjelder for den eller de periodene på fem år som søknaden er innlevert for, regnet fra den dagen registreringen ved det Internasjonale byrået anses å ha skjedd. Registreringen kan fornyes etter bestemmelsene i Genèveavtalen, se dl § 58 tredje ledd. Maksimal beskyttelsestid er 25 år.

(11) Reg.nr.:	DM/098209
(21) Søkn.nr.:	20171110
(22) Inngitt i WIPO:	2017.10.20
(15) Registrert i WIPO:	2017.10.20
(24) Løpedag:	2017.10.20
(43) Allm. tilgj.:	2018.04.20
(15) Besluttet gjeldende NO:	2018.06.20
(45) Kunngjort NO:	2018.07.16
(18) Reg. gjelder til:	2022.10.20
(73) Innehaver:	Caneias ANS, Holteveien 11, 1410 KOLBOTN, Norge

Design 1

(54) Produkt:	Snow fence [for roofs]
(51) Klasse:	25-02
(72) Designer:	Knut Knutsen, Holteveien 11, 1410 KOLBOTN
(55) Designavbildninger:	

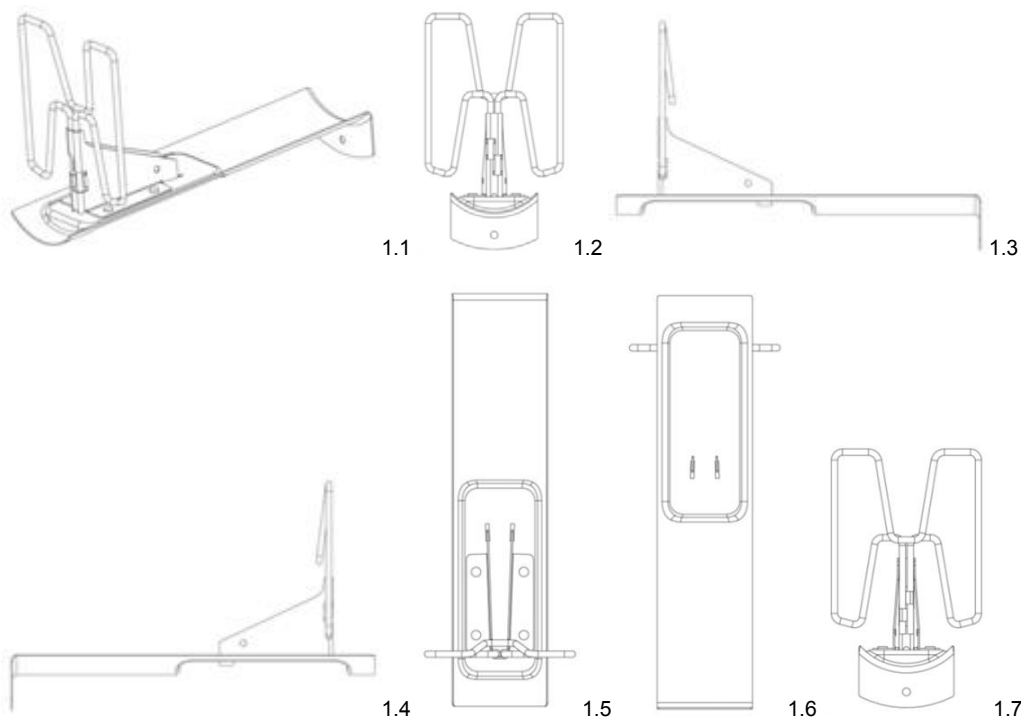

(11)	Reg.nr.:	DM/098234
(21)	Søkn.nr.:	20171111
(22)	Inngitt i WIPO:	2017.10.24
(15)	Registrert i WIPO:	2017.10.24
(24)	Løpedag:	2017.10.24
(43)	Allm. tilgj.:	2018.04.27
(15)	Besluttet gjeldende NO:	2018.06.20
(45)	Kunngjort NO:	2018.07.16
(18)	Reg. gjelder til:	2022.10.24
(73)	Innehaver:	SWATCH AG (SWATCH SA) (SWATCH LTD.), Jakob-Stämpfli-Strasse 94, CH-2502 BIEL/BIENNE, Sveits

Design 1

(54)	Produkt:	Wristwatch
(51)	Klasse:	10-02
(72)	Designer:	Bastien Leuba, Chemin des Charrières 10, 2024 ST-AUBIN-SAUGES, Sveits (CH)
(50)	Anmerkning:	Designet er i farger.
(55)	Designavbildninger:	



1.1



1.2



1.3

(11)	Reg.nr.:	DM/098237
(21)	Søkn.nr.:	20171112
(22)	Inngitt i WIPO:	2017.10.24
(15)	Registrert i WIPO:	2017.10.24
(24)	Løpedag:	2017.10.24
(43)	Allm. tilgj.:	2018.04.27
(15)	Besluttet gjeldende NO:	2018.06.20
(45)	Kunngjort NO:	2018.07.16
(18)	Reg. gjelder til:	2022.10.24
(73)	Innehaver:	SWATCH AG (SWATCH SA) (SWATCH LTD.), Jakob-Stämpfli-Strasse 94, CH-2502 BIEL/BIENNE, Sveits

Design 1

(54)	Produkt:	Wristwatch
(51)	Klasse:	10-02
(72)	Designer:	Anais KREBS, Faubourg de la Gare 3, 2000 NEUCHÂTEL, Sveits (CH)
(50)	Anmerkning:	Designet er i farger.
(55)	Designavbildninger:	



1.1



1.2



1.3

(11)	Reg.nr.:	DM/098238
(21)	Søkn.nr.:	20171113
(22)	Inngitt i WIPO:	2017.10.24
(15)	Registrert i WIPO:	2017.10.24
(24)	Løpedag:	2017.10.24
(43)	Allm. tilgj.:	2018.04.27
(15)	Besluttet gjeldende NO:	2018.06.20
(45)	Kunngjort NO:	2018.07.16
(18)	Reg. gjelder til:	2022.10.24
(73)	Innehaver:	SWATCH AG (SWATCH SA) (SWATCH LTD.), Jakob-Stämpfli-Strasse 94, CH-2502 BIEL/BIENNE, Sveits

Design 1

(54)	Produkt:	Wristwatch
(51)	Klasse:	10-02
(72)	Designer:	Stefano Novajra, Via Federico Campana 18/Bis, 10125 TORINO, Italia (IT)
(50)	Anmerkning:	Designet er i farger.
(55)	Designavbildninger:	



1.1



1.2



1.3

(11)	Reg.nr.:	DM/098241
(21)	Søkn.nr.:	20171102
(22)	Inngitt i WIPO:	2017.10.25
(15)	Registrert i WIPO:	2017.10.25
(24)	Løpedag:	2017.10.25
(43)	Allm. tilgj.:	2018.04.27
(15)	Besluttet gjeldende NO:	2018.06.20
(45)	Kunngjort NO:	2018.07.16
(18)	Reg. gjelder til:	2022.10.25
(73)	Innehaver:	PSA AUTOMOBILES SA, 2-10 Boulevard de l'Europe, FR-78300 POISSY, Frankrike
(50)	Anmerkninger:	Registreringen gjelder samregistrering.

Design 1

(54)	Produkt:	Left vehicle headlight
(51)	Klasse:	26-06
(72)	Designer:	Jean Pierre PLOUE, Route de Gisy, 78140 VELIZY VILLACOUBLAY, Frankrike (FR)
(55)	Designavbildninger:	

**Design 2**

(54)	Produkt:	Right vehicle headlight
(51)	Klasse:	26-06
(72)	Designer:	Jean Pierre PLOUE, Route de Gisy, 78140 VELIZY VILLACOUBLAY, Frankrike (FR)
(55)	Designavbildninger:	



**Design 3**

- (54) **Produkt:** Left vehicle headlight
(51) **Klasse:** 26-06
(72) **Designer:** Jean Pierre PLOUE, Route de Gisy, 78140 VELIZY VILLACOUBLAY, Frankrike (FR)
(55) **Designavbildninger:**



Design 4

- (54) **Produkt:** Right vehicle headlight
 (51) **Klasse:** 26-06
 (72) **Designer:** Jean Pierre PLOUE, Route de Gisy, 78140 VELIZY VILLACOUBLAY, Frankrike (FR)
 (55) **Designavbildninger:**

**Design 5**

- (54) **Produkt:** Right direction indicator for vehicles
 (51) **Klasse:** 26-06
 (72) **Designer:** Jean Pierre PLOUE, Route de Gisy, 78140 VELIZY VILLACOUBLAY, Frankrike (FR)
 (55) **Designavbildninger:**

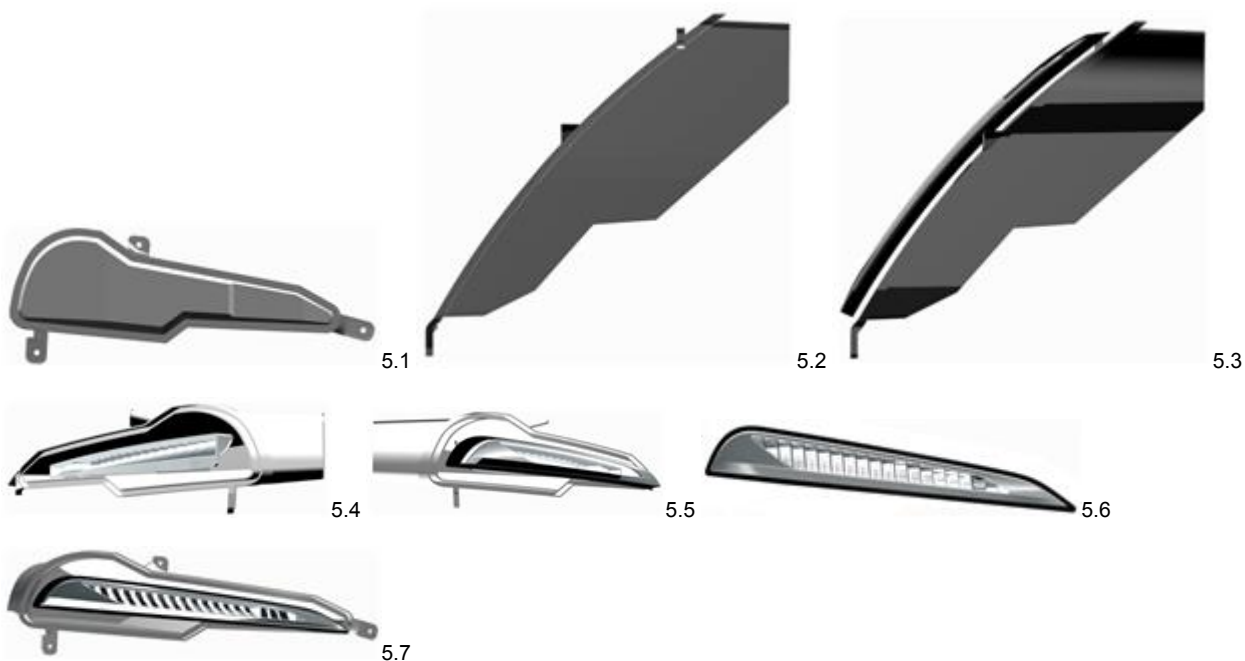

Design 6

- (54) **Produkt:** Left direction indicator for vehicles
(51) **Klasse:** 26-06
(72) **Designer:** Jean Pierre PLOUE, Route de Gisy, 78140 VELIZY VILLACOUBLAY, Frankrike (FR)
(55) **Designavbildninger:**



6.1



6.2



6.3



6.4



6.5



6.6



6.7

(11)	Reg.nr.:	DM/098295
(21)	Søkn.nr.:	20171201
(22)	Inngitt i WIPO:	2017.10.25
(15)	Registrert i WIPO:	2017.10.25
(24)	Løpedag:	2017.10.25
(43)	Allm. tilgj.:	2018.04.27
(15)	Besluttet gjeldende NO:	2018.06.20
(45)	Kunngjort NO:	2018.07.16
(18)	Reg. gjelder til:	2022.10.25
(73)	Innehaver:	The Procter & Gamble Company, One Procter & Gamble Plaza, US-OH45202 CINCINNATI, USA
(50)	Anmerkninger:	Registreringen gjelder samregistrering.

Design 1

(54)	Produkt:	Ornamentation
(51)	Klasse:	32-00
(72)	Designer:	Rob Clarke, c/o Elmwood 105 Water Lane, LS115WD LEEDS, ENGLAND, Storbritannia (GB) Alex Jessel, c/o Elmwood 105 Water Lane, LS115WD LEEDS, ENGLAND, Storbritannia (GB) Andy Lawrence, c/o Elmwood 105 Water Lane, LS115WD LEEDS, ENGLAND, Storbritannia (GB) Zoe Phillipson, c/o Elmwood 105 Water Lane, LS115WD LEEDS, ENGLAND, Storbritannia (GB)
(50)	Anmerkning:	Designet er i farger.
(55)	Designavbildninger:	



1.1

Design 2

(54)	Produkt:	Ornamentation
(51)	Klasse:	32-00
(72)	Designer:	Rob Clarke, c/o Elmwood 105 Water Lane, LS115WD LEEDS, ENGLAND, Storbritannia (GB) Alex Jessel, c/o Elmwood 105 Water Lane, LS115WD LEEDS, ENGLAND, Storbritannia (GB) Andy Lawrence, c/o Elmwood 105 Water Lane, LS115WD LEEDS, ENGLAND, Storbritannia (GB) Zoe Phillipson, c/o Elmwood 105 Water Lane, LS115WD LEEDS, ENGLAND, Storbritannia (GB)
(55)	Designavbildninger:	



2.1

Design 3

- (54) **Produkt:** Ornamentation
(51) **Klasse:** 32-00
(72) **Designer:** Rob Clarke, c/o Elmwood 105 Water Lane, LS115WD LEEDS, ENGLAND, Storbritannia (GB)
Alex Jessel, c/o Elmwood 105 Water Lane, LS115WD LEEDS, ENGLAND, Storbritannia (GB)
Andy Lawrence, c/o Elmwood 105 Water Lane, LS115WD LEEDS, ENGLAND, Storbritannia (GB)
Zoe Phillipson, c/o Elmwood 105 Water Lane, LS115WD LEEDS, ENGLAND, Storbritannia (GB)
- (50) **Anmerkning:** Designet er i farger.
(55) **Designavbildninger:**



3.1

Design 4

- (54) **Produkt:** Ornamentation
(51) **Klasse:** 32-00
(72) **Designer:** Rob Clarke, c/o Elmwood 105 Water Lane, LS115WD LEEDS, ENGLAND, Storbritannia (GB)
Alex Jessel, c/o Elmwood 105 Water Lane, LS115WD LEEDS, ENGLAND, Storbritannia (GB)
Andy Lawrence, c/o Elmwood 105 Water Lane, LS115WD LEEDS, ENGLAND, Storbritannia (GB)
Zoe Phillipson, c/o Elmwood 105 Water Lane, LS115WD LEEDS, ENGLAND, Storbritannia (GB)
- (50) **Anmerkning:** Designet er i farger.
(55) **Designavbildninger:**



4.1

Design 5

- (54) **Produkt:** Ornamentation
(51) **Klasse:** 32-00
(72) **Designer:** Rob Clarke, c/o Elmwood 105 Water Lane, LS115WD LEEDS, ENGLAND, Storbritannia (GB)
Alex Jessel, c/o Elmwood 105 Water Lane, LS115WD LEEDS, ENGLAND, Storbritannia (GB)
Andy Lawrence, c/o Elmwood 105 Water Lane, LS115WD LEEDS, ENGLAND, Storbritannia (GB)
Zoe Phillipson, c/o Elmwood 105 Water Lane, LS115WD LEEDS, ENGLAND, Storbritannia (GB)
- (50) **Anmerkning:** Designet er i farger.
(55) **Designavbildninger:**



5.1

Design 6

- (54) **Produkt:** Ornamentation
(51) **Klasse:** 32-00
(72) **Designer:** Rob Clarke, c/o Elmwood 105 Water Lane, LS115WD LEEDS, ENGLAND, Storbritannia (GB)
Alex Jessel, c/o Elmwood 105 Water Lane, LS115WD LEEDS, ENGLAND, Storbritannia (GB)
Andy Lawrence, c/o Elmwood 105 Water Lane, LS115WD LEEDS, ENGLAND, Storbritannia (GB)
Zoe Phillipson, c/o Elmwood 105 Water Lane, LS115WD LEEDS, ENGLAND, Storbritannia (GB)
- (50) **Anmerkning:** Designet er i farger.
(55) **Designavbildninger:**



6.1

Design 7

- (54) **Produkt:** Ornamentation
(51) **Klasse:** 32-00
(72) **Designer:** Rob Clarke, c/o Elmwood 105 Water Lane, LS115WD LEEDS, ENGLAND, Storbritannia (GB)
Alex Jessel, c/o Elmwood 105 Water Lane, LS115WD LEEDS, ENGLAND, Storbritannia (GB)
Andy Lawrence, c/o Elmwood 105 Water Lane, LS115WD LEEDS, ENGLAND, Storbritannia (GB)
Zoe Phillipson, c/o Elmwood 105 Water Lane, LS115WD LEEDS, ENGLAND, Storbritannia (GB)
- (50) **Anmerkning:** Designet er i farger.
(55) **Designavbildninger:**



7.1

Design 8

- (54) **Produkt:** Ornamentation
(51) **Klasse:** 32-00
(72) **Designer:** Rob Clarke, c/o Elmwood 105 Water Lane, LS115WD LEEDS, ENGLAND, Storbritannia (GB)
Alex Jessel, c/o Elmwood 105 Water Lane, LS115WD LEEDS, ENGLAND, Storbritannia (GB)
Andy Lawrence, c/o Elmwood 105 Water Lane, LS115WD LEEDS, ENGLAND, Storbritannia (GB)
Zoe Phillipson, c/o Elmwood 105 Water Lane, LS115WD LEEDS, ENGLAND, Storbritannia (GB)
- (50) **Anmerkning:** Designet er i farger.
(55) **Designavbildninger:**



8.1

Design 9

- (54) **Produkt:** Ornamentation
(51) **Klasse:** 32-00
(72) **Designer:** Rob Clarke, c/o Elmwood 105 Water Lane, LS115WD LEEDS, ENGLAND, Storbritannia (GB)
Alex Jessel, c/o Elmwood 105 Water Lane, LS115WD LEEDS, ENGLAND, Storbritannia (GB)
Andy Lawrence, c/o Elmwood 105 Water Lane, LS115WD LEEDS, ENGLAND, Storbritannia (GB)
Zoe Phillipson, c/o Elmwood 105 Water Lane, LS115WD LEEDS, ENGLAND, Storbritannia (GB)
- (50) **Anmerkning:** Designet er i farger.
(55) **Designavbildninger:**



9.1

Design 10

- (54) **Produkt:** Ornamentation
(51) **Klasse:** 32-00
(72) **Designer:** Rob Clarke, c/o Elmwood 105 Water Lane, LS115WD LEEDS, ENGLAND, Storbritannia (GB)
Alex Jessel, c/o Elmwood 105 Water Lane, LS115WD LEEDS, ENGLAND, Storbritannia (GB)
Andy Lawrence, c/o Elmwood 105 Water Lane, LS115WD LEEDS, ENGLAND, Storbritannia (GB)
Zoe Phillipson, c/o Elmwood 105 Water Lane, LS115WD LEEDS, ENGLAND, Storbritannia (GB)
- (50) **Anmerkning:** Designet er i farger.
(55) **Designavbildninger:**



10.1

Design 11

- (54) **Produkt:** Ornamentation
(51) **Klasse:** 32-00
(72) **Designer:** Rob Clarke, c/o Elmwood 105 Water Lane, LS115WD LEEDS, ENGLAND, Storbritannia (GB)
Alex Jessel, c/o Elmwood 105 Water Lane, LS115WD LEEDS, ENGLAND, Storbritannia (GB)
Andy Lawrence, c/o Elmwood 105 Water Lane, LS115WD LEEDS, ENGLAND, Storbritannia (GB)
Zoe Phillipson, c/o Elmwood 105 Water Lane, LS115WD LEEDS, ENGLAND, Storbritannia (GB)
- (50) **Anmerkning:** Designet er i farger.
(55) **Designavbildninger:**



11.1

Design 12

- (54) **Produkt:** Ornamentation
(51) **Klasse:** 32-00
(72) **Designer:** Rob Clarke, c/o Elmwood 105 Water Lane, LS115WD LEEDS, ENGLAND, Storbritannia (GB)
Alex Jessel, c/o Elmwood 105 Water Lane, LS115WD LEEDS, ENGLAND, Storbritannia (GB)
Andy Lawrence, c/o Elmwood 105 Water Lane, LS115WD LEEDS, ENGLAND, Storbritannia (GB)
Zoe Phillipson, c/o Elmwood 105 Water Lane, LS115WD LEEDS, ENGLAND, Storbritannia (GB)
- (50) **Anmerkning:** Designet er i farger.
(55) **Designavbildninger:**



12.1

Design 13

- (54) **Produkt:** Ornamentation
(51) **Klasse:** 32-00
(72) **Designer:** Rob Clarke, c/o Elmwood 105 Water Lane, LS115WD LEEDS, ENGLAND, Storbritannia (GB)
Alex Jessel, c/o Elmwood 105 Water Lane, LS115WD LEEDS, ENGLAND, Storbritannia (GB)
Andy Lawrence, c/o Elmwood 105 Water Lane, LS115WD LEEDS, ENGLAND, Storbritannia (GB)
Zoe Phillipson, c/o Elmwood 105 Water Lane, LS115WD LEEDS, ENGLAND, Storbritannia (GB)
- (50) **Anmerkning:** Designet er i farger.
(55) **Designavbildninger:**



13.1

Design 14

- (54) **Produkt:** Ornamentation
(51) **Klasse:** 32-00
(72) **Designer:** Rob Clarke, c/o Elmwood 105 Water Lane, LS115WD LEEDS, ENGLAND, Storbritannia (GB)
Alex Jessel, c/o Elmwood 105 Water Lane, LS115WD LEEDS, ENGLAND, Storbritannia (GB)
Andy Lawrence, c/o Elmwood 105 Water Lane, LS115WD LEEDS, ENGLAND, Storbritannia (GB)
Zoe Phillipson, c/o Elmwood 105 Water Lane, LS115WD LEEDS, ENGLAND, Storbritannia (GB)
- (50) **Anmerkning:** Designet er i farger.
(55) **Designavbildninger:**



14.1

Design 15

- (54) **Produkt:** Ornamentation
(51) **Klasse:** 32-00
(72) **Designer:** Rob Clarke, c/o Elmwood 105 Water Lane, LS115WD LEEDS, ENGLAND, Storbritannia (GB)
Alex Jessel, c/o Elmwood 105 Water Lane, LS115WD LEEDS, ENGLAND, Storbritannia (GB)
Andy Lawrence, c/o Elmwood 105 Water Lane, LS115WD LEEDS, ENGLAND, Storbritannia (GB)
Zoe Phillipson, c/o Elmwood 105 Water Lane, LS115WD LEEDS, ENGLAND, Storbritannia (GB)
- (50) **Anmerkning:** Designet er i farger.
(55) **Designavbildninger:**



15.1

Design 16

- (54) **Produkt:** Ornamentation
(51) **Klasse:** 32-00
(72) **Designer:** Rob Clarke, c/o Elmwood 105 Water Lane, LS115WD LEEDS, ENGLAND, Storbritannia (GB)
Alex Jessel, c/o Elmwood 105 Water Lane, LS115WD LEEDS, ENGLAND, Storbritannia (GB)
Andy Lawrence, c/o Elmwood 105 Water Lane, LS115WD LEEDS, ENGLAND, Storbritannia (GB)
Zoe Phillipson, c/o Elmwood 105 Water Lane, LS115WD LEEDS, ENGLAND, Storbritannia (GB)
- (50) **Anmerkning:** Designet er i farger.
(55) **Designavbildninger:**



16.1

Design 17

- (54) **Produkt:** Ornamentation
(51) **Klasse:** 32-00
(72) **Designer:** Rob Clarke, c/o Elmwood 105 Water Lane, LS115WD LEEDS, ENGLAND, Storbritannia (GB)
Alex Jessel, c/o Elmwood 105 Water Lane, LS115WD LEEDS, ENGLAND, Storbritannia (GB)
Andy Lawrence, c/o Elmwood 105 Water Lane, LS115WD LEEDS, ENGLAND, Storbritannia (GB)
Zoe Phillipson, c/o Elmwood 105 Water Lane, LS115WD LEEDS, ENGLAND, Storbritannia (GB)
- (50) **Anmerkning:** Designet er i farger.
(55) **Designavbildninger:**



17.1

Design 18

- (54) **Produkt:** Ornamentation
(51) **Klasse:** 32-00
(72) **Designer:** Rob Clarke, c/o Elmwood 105 Water Lane, LS115WD LEEDS, ENGLAND, Storbritannia (GB)
Alex Jessel, c/o Elmwood 105 Water Lane, LS115WD LEEDS, ENGLAND, Storbritannia (GB)
Andy Lawrence, c/o Elmwood 105 Water Lane, LS115WD LEEDS, ENGLAND, Storbritannia (GB)
Zoe Phillipson, c/o Elmwood 105 Water Lane, LS115WD LEEDS, ENGLAND, Storbritannia (GB)
- (50) **Anmerkning:** Designet er i farger.
(55) **Designavbildninger:**



18.1

Design 19

- (54) **Produkt:** Ornamentation
(51) **Klasse:** 32-00
(72) **Designer:** Rob Clarke, c/o Elmwood 105 Water Lane, LS115WD LEEDS, ENGLAND, Storbritannia (GB)
Alex Jessel, c/o Elmwood 105 Water Lane, LS115WD LEEDS, ENGLAND, Storbritannia (GB)
Andy Lawrence, c/o Elmwood 105 Water Lane, LS115WD LEEDS, ENGLAND, Storbritannia (GB)
Zoe Phillipson, c/o Elmwood 105 Water Lane, LS115WD LEEDS, ENGLAND, Storbritannia (GB)
- (50) **Anmerkning:** Designet er i farger.
(55) **Designavbildninger:**



19.1

(11)	Reg.nr.:	DM/098296
(21)	Søkn.nr.:	20171200
(22)	Inngitt i WIPO:	2017.10.25
(15)	Registrert i WIPO:	2017.10.25
(24)	Løpedag:	2017.10.25
(43)	Allm. tilgj.:	2018.04.27
(15)	Besluttet gjeldende NO:	2018.06.20
(45)	Kunngjort NO:	2018.07.16
(18)	Reg. gjelder til:	2022.10.25
(73)	Innehaver:	The Procter & Gamble Company, One Procter & Gamble Plaza, US-OH45202 CINCINNATI, USA
(50)	Anmerkninger:	Registreringen gjelder samregistrering.

Design 1

(54)	Produkt:	Ornamentation
(51)	Klasse:	32-00
(72)	Designer:	Rob Clarke, c/o Elmwood 105 Water Lane, LS115WD LEEDS, ENGLAND, Storbritannia (GB) Alex Jessel, c/o Elmwood 105 Water Lane, LS115WD LEEDS, ENGLAND, Storbritannia (GB) Andy Lawrence, c/o Elmwood 105 Water Lane, LS115WD LEEDS, ENGLAND, Storbritannia (GB) Zoe Phillipson, c/o Elmwood 105 Water Lane, LS115WD LEEDS, ENGLAND, Storbritannia (GB)
(50)	Anmerknig:	Designet er i farger.
(55)	Designavbildninger:	



1.1

Design 2

(54)	Produkt:	Ornamentation
(51)	Klasse:	32-00
(72)	Designer:	Rob Clarke, c/o Elmwood 105 Water Lane, LS115WD LEEDS, ENGLAND, Storbritannia (GB) Alex Jessel, c/o Elmwood 105 Water Lane, LS115WD LEEDS, ENGLAND, Storbritannia (GB) Andy Lawrence, c/o Elmwood 105 Water Lane, LS115WD LEEDS, ENGLAND, Storbritannia (GB) Zoe Phillipson, c/o Elmwood 105 Water Lane, LS115WD LEEDS, ENGLAND, Storbritannia (GB)
(55)	Designavbildninger:	



2.1

Design 3

- (54) **Produkt:** Ornamentation
(51) **Klasse:** 32-00
(72) **Designer:** Rob Clarke, c/o Elmwood 105 Water Lane, LS115WD LEEDS, ENGLAND, Storbritannia (GB)
Alex Jessel, c/o Elmwood 105 Water Lane, LS115WD LEEDS, ENGLAND, Storbritannia (GB)
Andy Lawrence, c/o Elmwood 105 Water Lane, LS115WD LEEDS, ENGLAND, Storbritannia (GB)
Zoe Phillipson, c/o Elmwood 105 Water Lane, LS115WD LEEDS, ENGLAND, Storbritannia (GB)
- (50) **Anmerkning:** Designet er i farger.
(55) **Designavbildninger:**



3.1

Design 4

- (54) **Produkt:** Ornamentation
(51) **Klasse:** 32-00
(72) **Designer:** Rob Clarke, c/o Elmwood 105 Water Lane, LS115WD LEEDS, ENGLAND, Storbritannia (GB)
Alex Jessel, c/o Elmwood 105 Water Lane, LS115WD LEEDS, ENGLAND, Storbritannia (GB)
Andy Lawrence, c/o Elmwood 105 Water Lane, LS115WD LEEDS, ENGLAND, Storbritannia (GB)
Zoe Phillipson, c/o Elmwood 105 Water Lane, LS115WD LEEDS, ENGLAND, Storbritannia (GB)
- (50) **Anmerkning:** Designet er i farger.
(55) **Designavbildninger:**



4.1

Design 5

- (54) **Produkt:** Ornamentation
(51) **Klasse:** 32-00
(72) **Designer:** Rob Clarke, c/o Elmwood 105 Water Lane, LS115WD LEEDS, ENGLAND, Storbritannia (GB)
Alex Jessel, c/o Elmwood 105 Water Lane, LS115WD LEEDS, ENGLAND, Storbritannia (GB)
Andy Lawrence, c/o Elmwood 105 Water Lane, LS115WD LEEDS, ENGLAND, Storbritannia (GB)
Zoe Phillipson, c/o Elmwood 105 Water Lane, LS115WD LEEDS, ENGLAND, Storbritannia (GB)
- (50) **Anmerkning:** Designet er i farger.
(55) **Designavbildninger:**



5.1

Design 6

- (54) **Produkt:** Ornamentation
(51) **Klasse:** 32-00
(72) **Designer:** Rob Clarke, c/o Elmwood 105 Water Lane, LS115WD LEEDS, ENGLAND, Storbritannia (GB)
Alex Jessel, c/o Elmwood 105 Water Lane, LS115WD LEEDS, ENGLAND, Storbritannia (GB)
Andy Lawrence, c/o Elmwood 105 Water Lane, LS115WD LEEDS, ENGLAND, Storbritannia (GB)
Zoe Phillipson, c/o Elmwood 105 Water Lane, LS115WD LEEDS, ENGLAND, Storbritannia (GB)
- (50) **Anmerkning:** Designet er i farger.
(55) **Designavbildninger:**



6.1

Design 7

- (54) **Produkt:** Ornamentation
(51) **Klasse:** 32-00
(72) **Designer:** Rob Clarke, c/o Elmwood 105 Water Lane, LS115WD LEEDS, ENGLAND, Storbritannia (GB)
Alex Jessel, c/o Elmwood 105 Water Lane, LS115WD LEEDS, ENGLAND, Storbritannia (GB)
Andy Lawrence, c/o Elmwood 105 Water Lane, LS115WD LEEDS, ENGLAND, Storbritannia (GB)
Zoe Phillipson, c/o Elmwood 105 Water Lane, LS115WD LEEDS, ENGLAND, Storbritannia (GB)
- (50) **Anmerkning:** Designet er i farger.
(55) **Designavbildninger:**



7.1

Design 8

- (54) **Produkt:** Ornamentation
(51) **Klasse:** 32-00
(72) **Designer:** Rob Clarke, c/o Elmwood 105 Water Lane, LS115WD LEEDS, ENGLAND, Storbritannia (GB)
Alex Jessel, c/o Elmwood 105 Water Lane, LS115WD LEEDS, ENGLAND, Storbritannia (GB)
Andy Lawrence, c/o Elmwood 105 Water Lane, LS115WD LEEDS, ENGLAND, Storbritannia (GB)
Zoe Phillipson, c/o Elmwood 105 Water Lane, LS115WD LEEDS, ENGLAND, Storbritannia (GB)
- (50) **Anmerkning:** Designet er i farger.
(55) **Designavbildninger:**



8.1

Design 9

- (54) **Produkt:** Ornamentation
(51) **Klasse:** 32-00
(72) **Designer:** Rob Clarke, c/o Elmwood 105 Water Lane, LS115WD LEEDS, ENGLAND, Storbritannia (GB)
Alex Jessel, c/o Elmwood 105 Water Lane, LS115WD LEEDS, ENGLAND, Storbritannia (GB)
Andy Lawrence, c/o Elmwood 105 Water Lane, LS115WD LEEDS, ENGLAND, Storbritannia (GB)
Zoe Phillipson, c/o Elmwood 105 Water Lane, LS115WD LEEDS, ENGLAND, Storbritannia (GB)
- (50) **Anmerkning:** Designet er i farger.
(55) **Designavbildninger:**



9.1

Design 10

- (54) **Produkt:** Ornamentation
(51) **Klasse:** 32-00
(72) **Designer:** Rob Clarke, c/o Elmwood 105 Water Lane, LS115WD LEEDS, ENGLAND, Storbritannia (GB)
Alex Jessel, c/o Elmwood 105 Water Lane, LS115WD LEEDS, ENGLAND, Storbritannia (GB)
Andy Lawrence, c/o Elmwood 105 Water Lane, LS115WD LEEDS, ENGLAND, Storbritannia (GB)
Zoe Phillipson, c/o Elmwood 105 Water Lane, LS115WD LEEDS, ENGLAND, Storbritannia (GB)
- (50) **Anmerkning:** Designet er i farger.
(55) **Designavbildninger:**



10.1

Design 11

- (54) **Produkt:** Ornamentation
(51) **Klasse:** 32-00
(72) **Designer:** Rob Clarke, c/o Elmwood 105 Water Lane, LS115WD LEEDS, ENGLAND, Storbritannia (GB)
Alex Jessel, c/o Elmwood 105 Water Lane, LS115WD LEEDS, ENGLAND, Storbritannia (GB)
Andy Lawrence, c/o Elmwood 105 Water Lane, LS115WD LEEDS, ENGLAND, Storbritannia (GB)
Zoe Phillipson, c/o Elmwood 105 Water Lane, LS115WD LEEDS, ENGLAND, Storbritannia (GB)
- (50) **Anmerkning:**
(55) **Designavbildninger:** Designet er i farger.



11.1

Design 12

- (54) **Produkt:** Ornamentation
(51) **Klasse:** 32-00
(72) **Designer:** Rob Clarke, c/o Elmwood 105 Water Lane, LS115WD LEEDS, ENGLAND, Storbritannia (GB)
Alex Jessel, c/o Elmwood 105 Water Lane, LS115WD LEEDS, ENGLAND, Storbritannia (GB)
Andy Lawrence, c/o Elmwood 105 Water Lane, LS115WD LEEDS, ENGLAND, Storbritannia (GB)
Zoe Phillipson, c/o Elmwood 105 Water Lane, LS115WD LEEDS, ENGLAND, Storbritannia (GB)
- (50) **Anmerkning:**
(55) **Designavbildninger:** Designet er i farger.



12.1

Design 13

- (54) **Produkt:** Ornamentation
(51) **Klasse:** 32-00
(72) **Designer:** Rob Clarke, c/o Elmwood 105 Water Lane, LS115WD LEEDS, ENGLAND, Storbritannia (GB)
Alex Jessel, c/o Elmwood 105 Water Lane, LS115WD LEEDS, ENGLAND, Storbritannia (GB)
Andy Lawrence, c/o Elmwood 105 Water Lane, LS115WD LEEDS, ENGLAND, Storbritannia (GB)
Zoe Phillipson, c/o Elmwood 105 Water Lane, LS115WD LEEDS, ENGLAND, Storbritannia (GB)
- (50) **Anmerkning:**
(55) **Designavbildninger:** Designet er i farger.



13.1

Design 14

- (54) **Produkt:** Ornamentation
(51) **Klasse:** 32-00
(72) **Designer:** Rob Clarke, c/o Elmwood 105 Water Lane, LS115WD LEEDS, ENGLAND, Storbritannia (GB)
Alex Jessel, c/o Elmwood 105 Water Lane, LS115WD LEEDS, ENGLAND, Storbritannia (GB)
Andy Lawrence, c/o Elmwood 105 Water Lane, LS115WD LEEDS, ENGLAND, Storbritannia (GB)
Zoe Phillipson, c/o Elmwood 105 Water Lane, LS115WD LEEDS, ENGLAND, Storbritannia (GB)
- (50) **Anmerkning:**
(55) **Designavbildninger:** Designet er i farger.



14.1

Design 15

- (54) **Produkt:** Ornamentation
(51) **Klasse:** 32-00
(72) **Designer:** Rob Clarke, c/o Elmwood 105 Water Lane, LS115WD LEEDS, ENGLAND, Storbritannia (GB)
Alex Jessel, c/o Elmwood 105 Water Lane, LS115WD LEEDS, ENGLAND, Storbritannia (GB)
Andy Lawrence, c/o Elmwood 105 Water Lane, LS115WD LEEDS, ENGLAND, Storbritannia (GB)
Zoe Phillipson, c/o Elmwood 105 Water Lane, LS115WD LEEDS, ENGLAND, Storbritannia (GB)
- (50) **Anmerkning:** Designet er i farger.
(55) **Designavbildninger:**



15.1

Design 16

- (54) **Produkt:** Ornamentation
(51) **Klasse:** 32-00
(72) **Designer:** Rob Clarke, c/o Elmwood 105 Water Lane, LS115WD LEEDS, ENGLAND, Storbritannia (GB)
Alex Jessel, c/o Elmwood 105 Water Lane, LS115WD LEEDS, ENGLAND, Storbritannia (GB)
Andy Lawrence, c/o Elmwood 105 Water Lane, LS115WD LEEDS, ENGLAND, Storbritannia (GB)
Zoe Phillipson, c/o Elmwood 105 Water Lane, LS115WD LEEDS, ENGLAND, Storbritannia (GB)
- (50) **Anmerkning:** Designet er i farger.
(55) **Designavbildninger:**



16.1

Design 17

- (54) **Produkt:** Ornamentation
(51) **Klasse:** 32-00
(72) **Designer:** Rob Clarke, c/o Elmwood 105 Water Lane, LS115WD LEEDS, ENGLAND, Storbritannia (GB)
Alex Jessel, c/o Elmwood 105 Water Lane, LS115WD LEEDS, ENGLAND, Storbritannia (GB)
Andy Lawrence, c/o Elmwood 105 Water Lane, LS115WD LEEDS, ENGLAND, Storbritannia (GB)
Zoe Phillipson, c/o Elmwood 105 Water Lane, LS115WD LEEDS, ENGLAND, Storbritannia (GB)
- (50) **Anmerkning:** Designet er i farger.
(55) **Designavbildninger:**



17.1

(11)	Reg.nr.:	DM/098347
(21)	Søkn.nr.:	20171197
(22)	Inngitt i WIPO:	2017.10.18
(15)	Registrert i WIPO:	2017.10.18
(24)	Løpedag:	2017.10.18
(43)	Allm. tilgj.:	2018.04.20
(15)	Besluttet gjeldende NO:	2018.06.20
(45)	Kunngjort NO:	2018.07.16
(18)	Reg. gjelder til:	2022.10.18
(73)	Innehaver:	Koninklijke Philips N.V., High Tech Campus 5, NL-5656AE EINDHOVEN, Nederland
(50)	Anmerkninger:	Registreringen gjelder samregistrering.

Design 1

(54)	Produkt:	Shavers
(51)	Klasse:	28-03
(72)	Designer:	Jens Peter Kophmann Andersson, Zacharias Jansestraat 532, 1097CK AMSTERDAM, Nederland (NL)
(30)	Prioritet:	2017.05.03, EM, 003926005, 1, 2
(55)	Designavbildninger:	

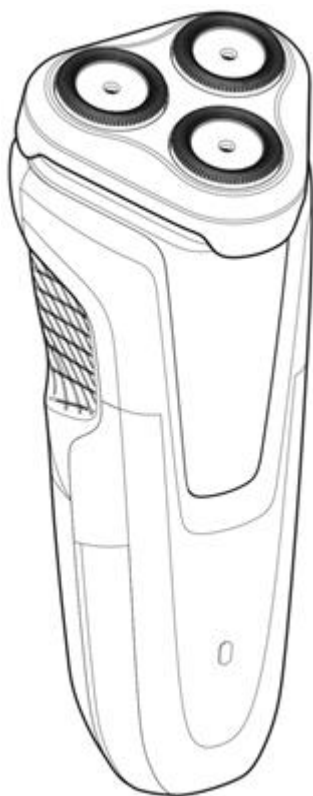

1.1

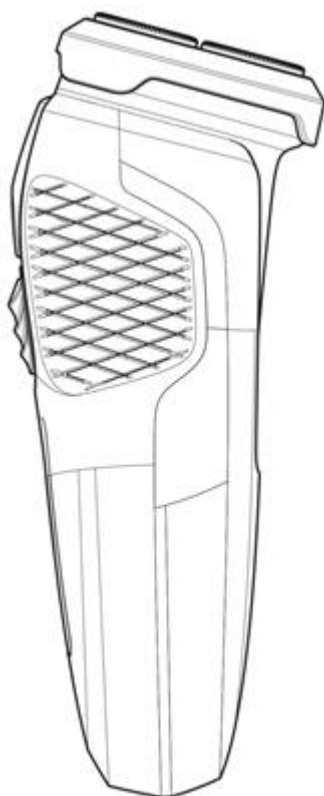

1.2

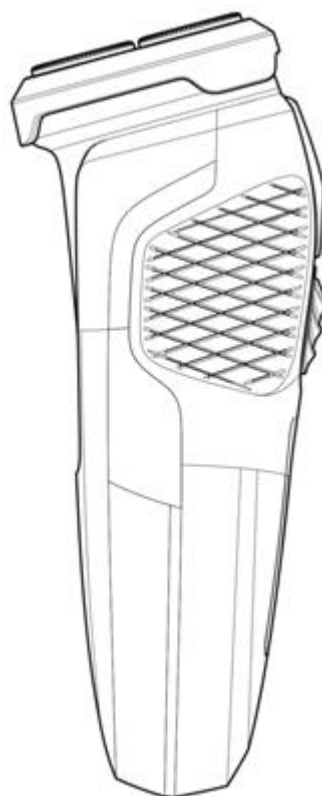

1.3

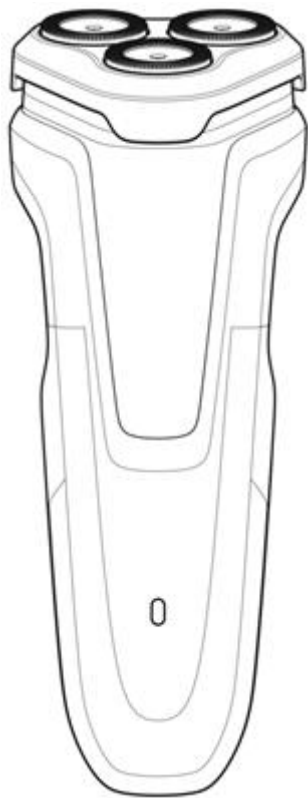

1.4

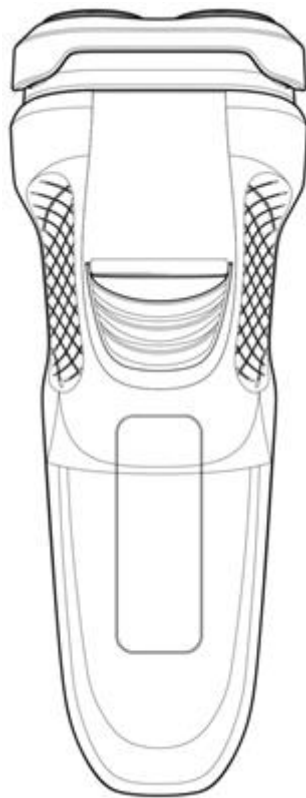

1.5

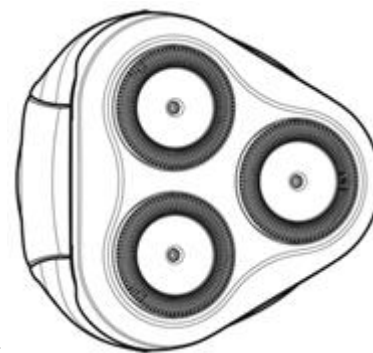

1.6

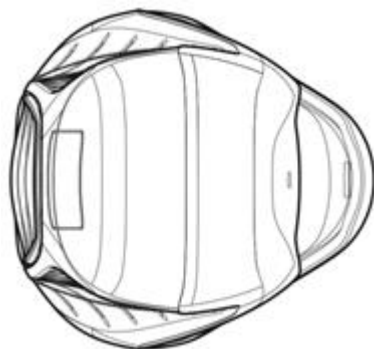

1.7

Design 2

- (54) **Produkt:** Shavers
(51) **Klasse:** 28-03
(72) **Designer:** Jens Peter Kophmann Andersson, Zacharias Jansestraat 532, 1097CK AMSTERDAM, Nederland (NL)
(30) **Prioritet:** 2017.05.03, EM, 003926005, 1, 2
(55) **Designavbildninger:**

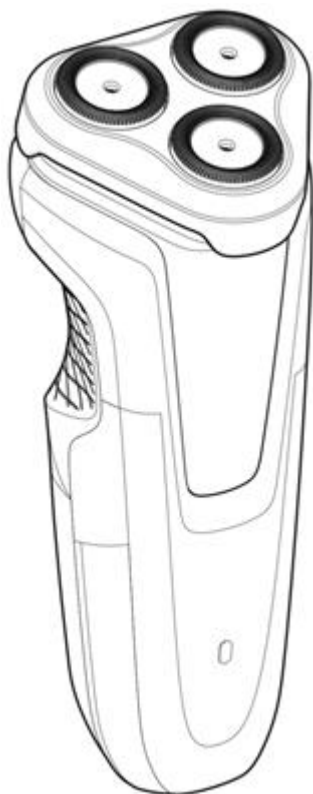

2.1

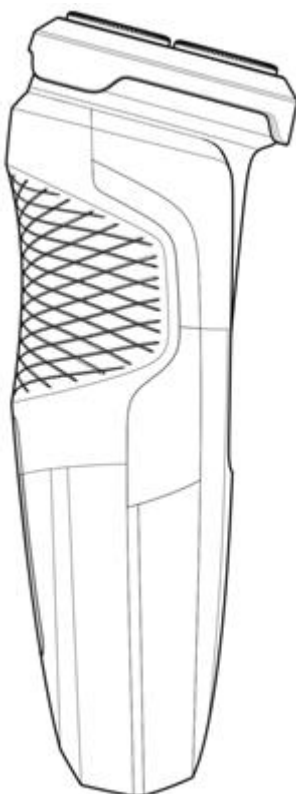

2.2

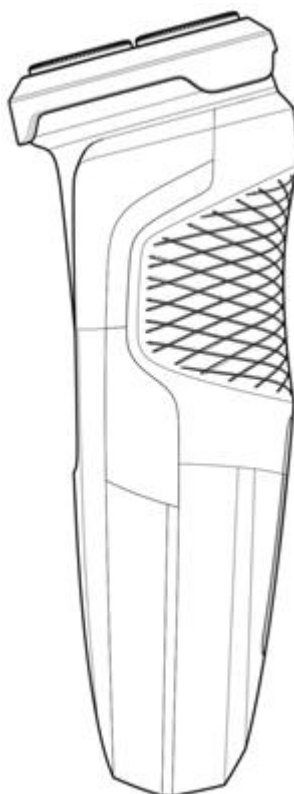

2.3

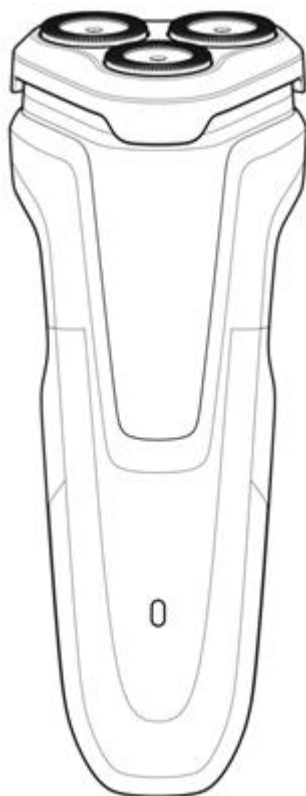

2.4

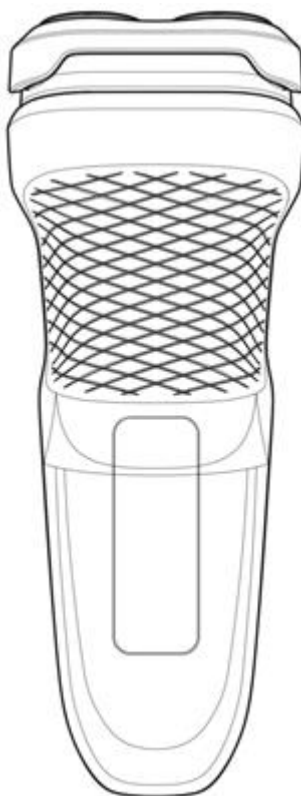

2.5

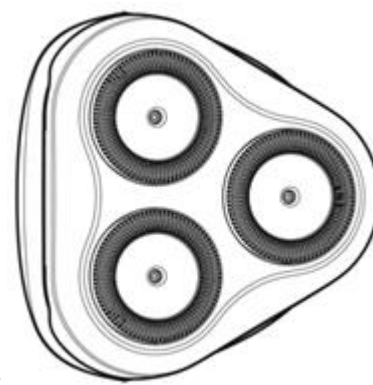

2.6

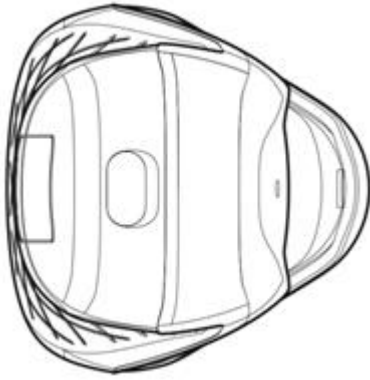

2.7

(11) Reg.nr.:	DM/098373
(21) Søkn.nr.:	20171198
(22) Inngitt i WIPO:	2017.10.20
(15) Registrert i WIPO:	2017.10.20
(24) Løpedag:	2017.10.20
(43) Allm. tilgj.:	2018.04.20
(15) Besluttet gjeldende NO:	2018.06.20
(45) Kunngjort NO:	2018.07.16
(18) Reg. gjelder til:	2022.10.20
(73) Innehaver:	O. Kleiner AG, Schützenmattweg 26, CH-5610 WOHLLEN, Sveits
(50) Anmerkninger:	Registreringen gjelder samregistrering.

Design 1

(54) Produkt:	Lids for a preserve can
(51) Klasse:	09-07
(72) Designer:	Martin KLEINER, Bankweg 33, 5610 WOHLLEN, Sveits (CH)
(55) Designavbildninger:	

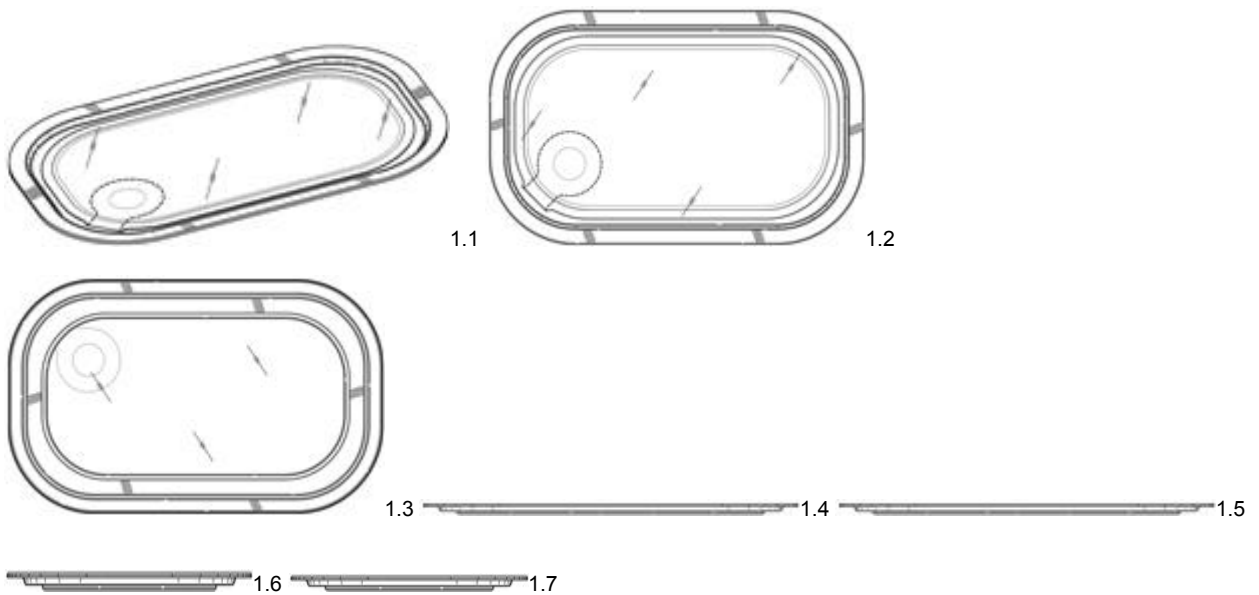
**Design 2**

(54) Produkt:	Lids for a preserve can
(51) Klasse:	09-07
(72) Designer:	Martin KLEINER, Bankweg 33, 5610 WOHLLEN, Sveits (CH)
(55) Designavbildninger:	

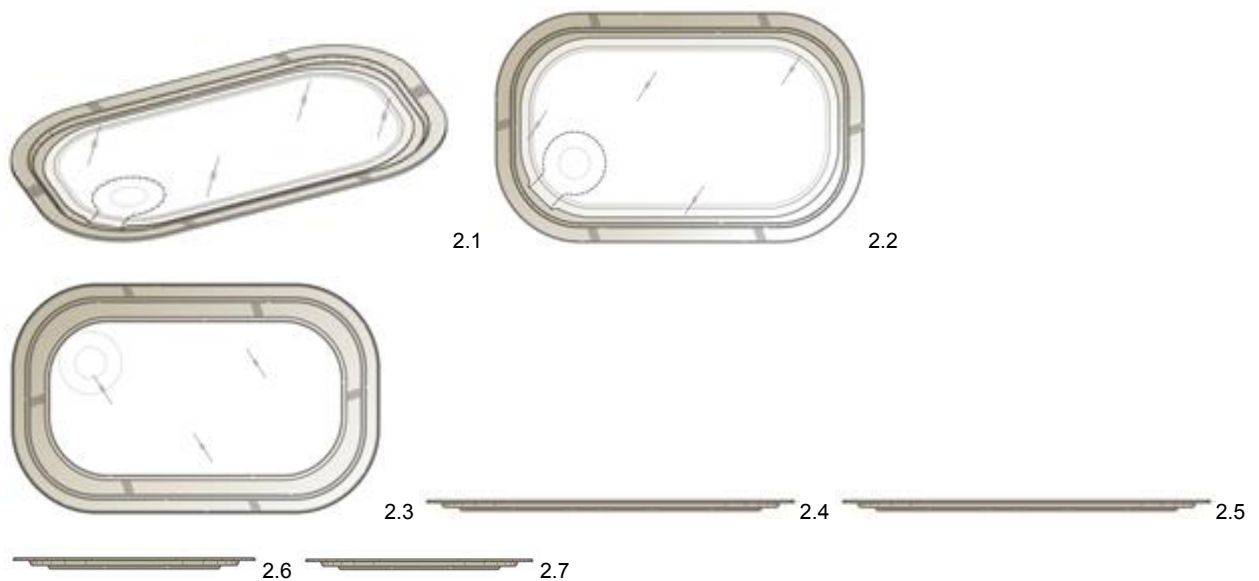

Design 3

- (54) **Produkt:** Preserve can
(51) **Klasse:** 09-03
(72) **Designer:** Martin KLEINER, Bankweg 33, 5610 WOHLLEN, Sveits (CH)
(55) **Designavbildninger:**

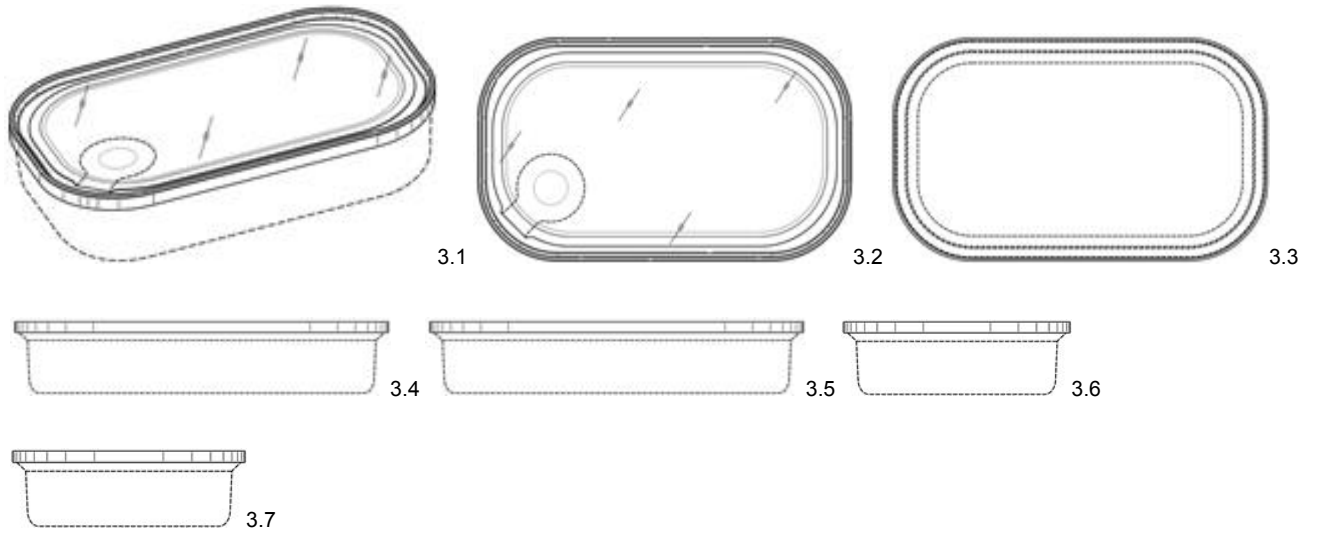

(11)	Reg.nr.:	DM/098415
(21)	Søkn.nr.:	20171199
(22)	Inngitt i WIPO:	2017.10.25
(15)	Registrert i WIPO:	2017.10.25
(24)	Løpedag:	2017.10.25
(43)	Allm. tilgj.:	2018.04.27
(15)	Besluttet gjeldende NO:	2018.06.20
(45)	Kunngjort NO:	2018.07.16
(18)	Reg. gjelder til:	2022.10.25
(73)	Innehaver:	EIS GMBH, Am Lenkwerk 3, DE-33609 BIELEFELD, Tyskland
(50)	Anmerkninger:	Registreringen gjelder samregistrering.

Design 1

(54)	Produkt:	Adult toys
(51)	Klasse:	28-03
(72)	Designer:	Paul Fally, Heinrich-Hertz-Strasse 37, 22085 HAMBURG, Tyskland (DE) Johanna Königsberger, c/o Tiemann, Treskowstrasse 30, 20257 HAMBURG, Tyskland (DE) Won-Gyung Lee, Boberger Strasse 17, 22111 HAMBURG, Tyskland (DE) Jan Meissner, Rellinger Str. 18, 20257 HAMBURG, Tyskland (DE) Tobias Schreier, Karolinenstr. 14, 20357 HAMBURG, Tyskland (DE)

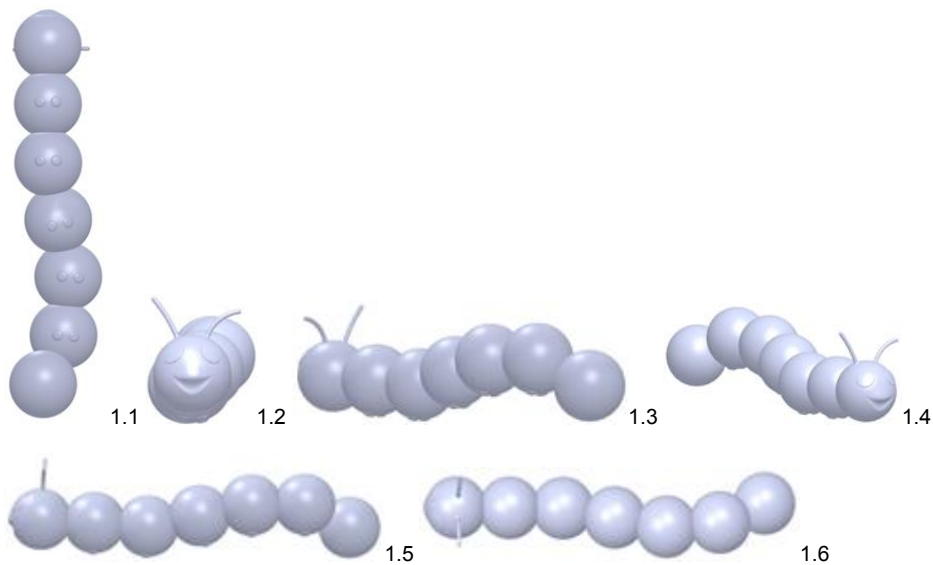
(55) **Designavbildninger:**

Design 2

- (54) **Produkt:** Adult toys
(51) **Klasse:** 28-03
(72) **Designer:** Paul Fally, Heinrich-Hertz-Strasse 37, 22085 HAMBURG, Tyskland (DE)
Johanna Königsberger, c/o Tiemann, Treskowstrasse 30, 20257 HAMBURG, Tyskland (DE)
Won-Gyung Lee, Boberger Strasse 17, 22111 HAMBURG, Tyskland (DE)
Jan Meissner, Rellinger Str. 18, 20257 HAMBURG, Tyskland (DE)
Tobias Schreier, Karolinenstr. 14, 20357 HAMBURG, Tyskland (DE)

(55) **Designavbildninger:**



Design 3

- (54) **Produkt:** Adult toys
(51) **Klasse:** 28-03
(72) **Designer:** Paul Fally, Heinrich-Hertz-Strasse 37, 22085 HAMBURG, Tyskland (DE)
Johanna Königsberger, c/o Tiemann, Treskowstrasse 30, 20257 HAMBURG, Tyskland (DE)
Won-Gyung Lee, Boberger Strasse 17, 22111 HAMBURG, Tyskland (DE)
Jan Meissner, Rellinger Str. 18, 20257 HAMBURG, Tyskland (DE)
Tobias Schreier, Karolinenstr. 14, 20357 HAMBURG, Tyskland (DE)

(55) **Designavbildninger:**



Design 4

- (54) **Produkt:** Adult toys
(51) **Klasse:** 28-03
(72) **Designer:** Paul Fally, Heinrich-Hertz-Strasse 37, 22085 HAMBURG, Tyskland (DE)
Johanna Königsberger, c/o Tiemann, Treskowstrasse 30, 20257 HAMBURG, Tyskland (DE)
Won-Gyung Lee, Boberger Strasse 17, 22111 HAMBURG, Tyskland (DE)
Jan Meissner, Rellinger Str. 18, 20257 HAMBURG, Tyskland (DE)
Tobias Schreier, Karolinenstr. 14, 20357 HAMBURG, Tyskland (DE)

(55) **Designavbildninger:**



Design 5

- (54) **Produkt:** Adult toys
(51) **Klasse:** 28-03
(72) **Designer:** Paul Fally, Heinrich-Hertz-Strasse 37, 22085 HAMBURG, Tyskland (DE)
Johanna Königsberger, c/o Tiemann, Treskowstrasse 30, 20257 HAMBURG, Tyskland (DE)
Won-Gyung Lee, Boberger Strasse 17, 22111 HAMBURG, Tyskland (DE)
Jan Meissner, Rellinger Str. 18, 20257 HAMBURG, Tyskland (DE)
Tobias Schreier, Karolinenstr. 14, 20357 HAMBURG, Tyskland (DE)

(55) Designavbildninger:

Design 6

- (54) **Produkt:** Adult toys
(51) **Klasse:** 28-03
(72) **Designer:** Paul Fally, Heinrich-Hertz-Strasse 37, 22085 HAMBURG, Tyskland (DE)
Johanna Königsberger, c/o Tiemann, Treskowstrasse 30, 20257 HAMBURG, Tyskland (DE)
Won-Gyung Lee, Boberger Strasse 17, 22111 HAMBURG, Tyskland (DE)
Jan Meissner, Rellinger Str. 18, 20257 HAMBURG, Tyskland (DE)
Tobias Schreier, Karolinenstr. 14, 20357 HAMBURG, Tyskland (DE)

(55) Designavbildninger:

6.1



6.2



6.3



6.4

Design 7

- (54) **Produkt:** Adult toys
(51) **Klasse:** 28-03
(72) **Designer:** Paul Fally, Heinrich-Hertz-Strasse 37, 22085 HAMBURG, Tyskland (DE)
Johanna Königsberger, c/o Tiemann, Treskowstrasse 30, 20257 HAMBURG, Tyskland (DE)
Won-Gyung Lee, Boberger Strasse 17, 22111 HAMBURG, Tyskland (DE)
Jan Meissner, Rellinger Str. 18, 20257 HAMBURG, Tyskland (DE)
Tobias Schreier, Karolinenstr. 14, 20357 HAMBURG, Tyskland (DE)
- (55) **Designavbildninger:**

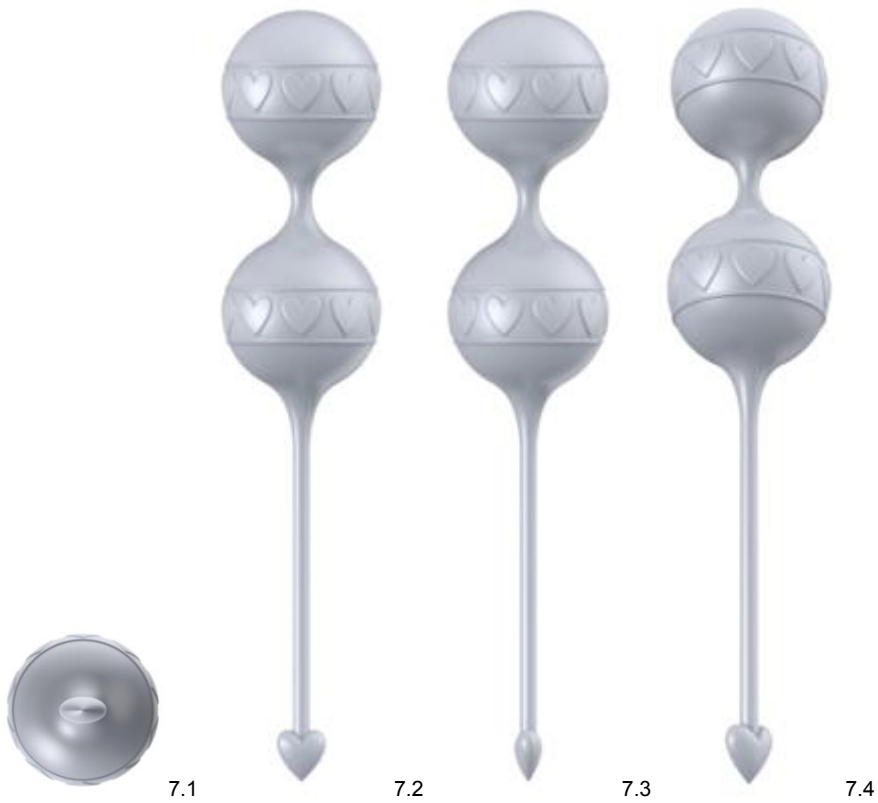

Design 8

- (54) **Produkt:** Adult toys
(51) **Klasse:** 28-03
(72) **Designer:** Paul Fally, Heinrich-Hertz-Strasse 37, 22085 HAMBURG, Tyskland (DE)
Johanna Königsberger, c/o Tiemann, Treskowstrasse 30, 20257 HAMBURG, Tyskland (DE)
Won-Gyung Lee, Boberger Strasse 17, 22111 HAMBURG, Tyskland (DE)
Jan Meissner, Rellinger Str. 18, 20257 HAMBURG, Tyskland (DE)
Tobias Schreier, Karolinenstr. 14, 20357 HAMBURG, Tyskland (DE)
- (55) **Designavbildninger:**

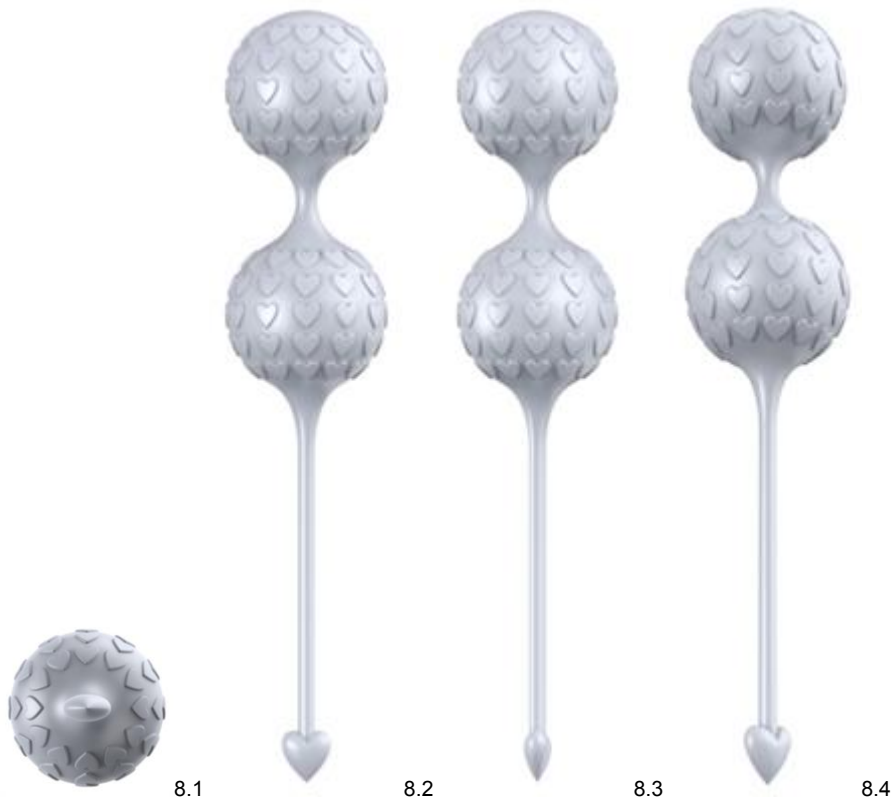

Design 9

- (54) **Produkt:** Adult toys
(51) **Klasse:** 28-03
(72) **Designer:** Paul Fally, Heinrich-Hertz-Strasse 37, 22085 HAMBURG, Tyskland (DE)
Johanna Königsberger, c/o Tiemann, Treskowstrasse 30, 20257 HAMBURG, Tyskland (DE)
Won-Gyung Lee, Boberger Strasse 17, 22111 HAMBURG, Tyskland (DE)
Jan Meissner, Rellinger Str. 18, 20257 HAMBURG, Tyskland (DE)
Tobias Schreier, Karolinenstr. 14, 20357 HAMBURG, Tyskland (DE)
- (55) **Designavbildninger:**

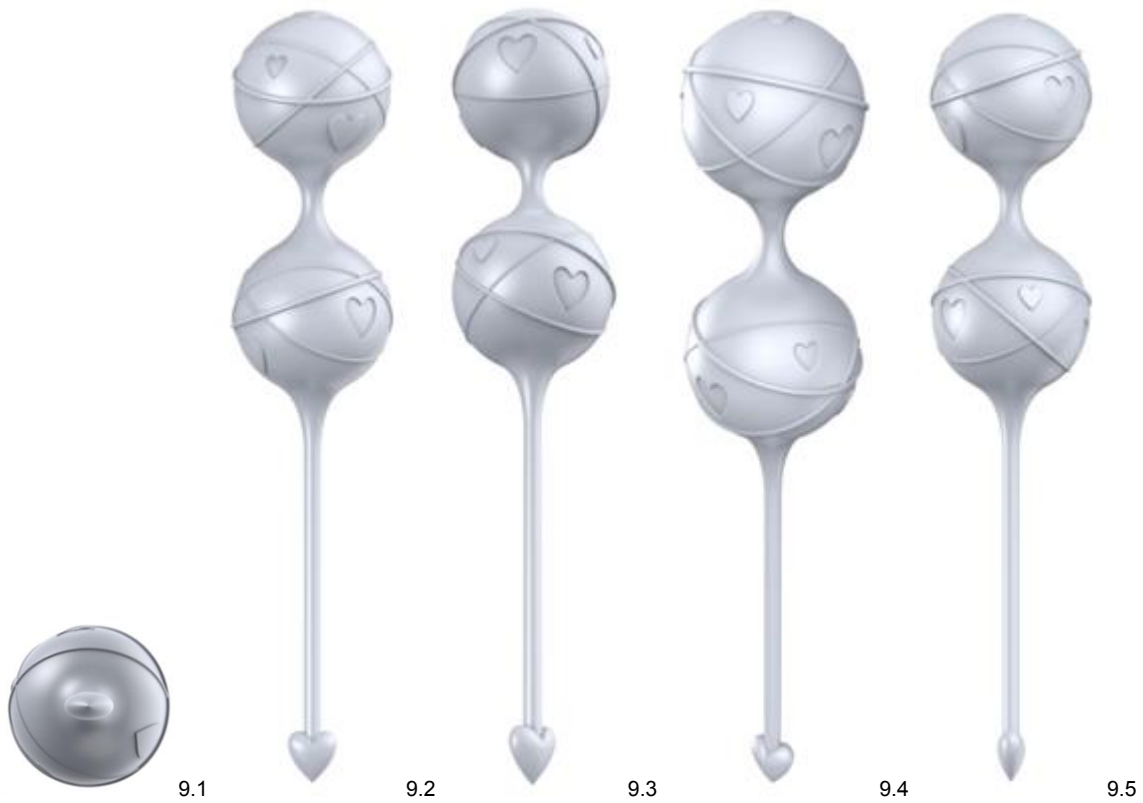

Design 10

- (54) **Produkt:** Adult toys
(51) **Klasse:** 28-03
(72) **Designer:** Paul Fally, Heinrich-Hertz-Strasse 37, 22085 HAMBURG, Tyskland (DE)
Johanna Königsberger, c/o Tiemann, Treskowstrasse 30, 20257 HAMBURG, Tyskland (DE)
Won-Gyung Lee, Boberger Strasse 17, 22111 HAMBURG, Tyskland (DE)
Jan Meissner, Rellinger Str. 18, 20257 HAMBURG, Tyskland (DE)
Tobias Schreier, Karolinenstr. 14, 20357 HAMBURG, Tyskland (DE)

(55) **Designavbildninger:**



10.1



10.2



10.3



10.4

Design 11

- (54) **Produkt:** Adult toys
(51) **Klasse:** 28-03
(72) **Designer:** Paul Fally, Heinrich-Hertz-Strasse 37, 22085 HAMBURG, Tyskland (DE)
Johanna Königsberger, c/o Tiemann, Treskowstrasse 30, 20257 HAMBURG, Tyskland (DE)
Won-Gyung Lee, Boberger Strasse 17, 22111 HAMBURG, Tyskland (DE)
Jan Meissner, Rellinger Str. 18, 20257 HAMBURG, Tyskland (DE)
Tobias Schreier, Karolinenstr. 14, 20357 HAMBURG, Tyskland (DE)

(55) **Designavbildninger:**

Design 12

- (54) **Produkt:** Adult toys
(51) **Klasse:** 28-03
(72) **Designer:** Paul Fally, Heinrich-Hertz-Strasse 37, 22085 HAMBURG, Tyskland (DE)
Johanna Königsberger, c/o Tiemann, Treskowstrasse 30, 20257 HAMBURG, Tyskland (DE)
Won-Gyung Lee, Boberger Strasse 17, 22111 HAMBURG, Tyskland (DE)
Jan Meissner, Rellinger Str. 18, 20257 HAMBURG, Tyskland (DE)
Tobias Schreier, Karolinenstr. 14, 20357 HAMBURG, Tyskland (DE)

(55) Designavbildninger:

12.1



12.2



12.3



12.4



12.5

Design 13

- (54) **Produkt:** Adult toys
(51) **Klasse:** 28-03
(72) **Designer:** Paul Fally, Heinrich-Hertz-Strasse 37, 22085 HAMBURG, Tyskland (DE)
Johanna Königsberger, c/o Tiemann, Treskowstrasse 30, 20257 HAMBURG, Tyskland (DE)
Won-Gyung Lee, Boberger Strasse 17, 22111 HAMBURG, Tyskland (DE)
Jan Meissner, Rellinger Str. 18, 20257 HAMBURG, Tyskland (DE)
Tobias Schreier, Karolinenstr. 14, 20357 HAMBURG, Tyskland (DE)

(55) **Designavbildninger:**



13.1



13.2



13.3



13.4

Design 14

- (54) **Produkt:** Adult toys
(51) **Klasse:** 28-03
(72) **Designer:** Paul Fally, Heinrich-Hertz-Strasse 37, 22085 HAMBURG, Tyskland (DE)
Johanna Königsberger, c/o Tiemann, Treskowstrasse 30, 20257 HAMBURG, Tyskland (DE)
Won-Gyung Lee, Boberger Strasse 17, 22111 HAMBURG, Tyskland (DE)
Jan Meissner, Rellinger Str. 18, 20257 HAMBURG, Tyskland (DE)
Tobias Schreier, Karolinenstr. 14, 20357 HAMBURG, Tyskland (DE)

(55) Designavbildninger:

14.1



14.2



14.3



14.4

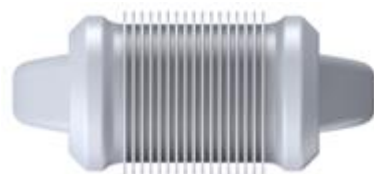

14.5

Design 15

(54) **Produkt:** Adult toys

(51) **Klasse:** 28-03

(72) **Designer:** Paul Fally, Heinrich-Hertz-Strasse 37, 22085 HAMBURG, Tyskland (DE)
Johanna Königsberger, c/o Tiemann, Treskowstrasse 30, 20257 HAMBURG, Tyskland (DE)
Won-Gyung Lee, Boberger Strasse 17, 22111 HAMBURG, Tyskland (DE)
Jan Meissner, Rellinger Str. 18, 20257 HAMBURG, Tyskland (DE)
Tobias Schreier, Karolinenstr. 14, 20357 HAMBURG, Tyskland (DE)

(55) **Designavbildninger:**



15.1



15.2



15.3



15.4

Design 16

- (54) **Produkt:** Adult toys
(51) **Klasse:** 28-03
(72) **Designer:** Paul Fally, Heinrich-Hertz-Strasse 37, 22085 HAMBURG, Tyskland (DE)
Johanna Königsberger, c/o Tiemann, Treskowstrasse 30, 20257 HAMBURG, Tyskland (DE)
Won-Gyung Lee, Boberger Strasse 17, 22111 HAMBURG, Tyskland (DE)
Jan Meissner, Rellinger Str. 18, 20257 HAMBURG, Tyskland (DE)
Tobias Schreier, Karolinenstr. 14, 20357 HAMBURG, Tyskland (DE)
- (55) **Designavbildninger:**



16.1



16.2



16.3



16.4

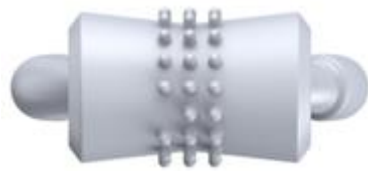

16.5

Design 17

- (54) **Produkt:** Adult toys
(51) **Klasse:** 28-03
(72) **Designer:** Paul Fally, Heinrich-Hertz-Strasse 37, 22085 HAMBURG, Tyskland (DE)
Johanna Königsberger, c/o Tiemann, Treskowstrasse 30, 20257 HAMBURG, Tyskland (DE)
Won-Gyung Lee, Boberger Strasse 17, 22111 HAMBURG, Tyskland (DE)
Jan Meissner, Rellinger Str. 18, 20257 HAMBURG, Tyskland (DE)
Tobias Schreier, Karolinenstr. 14, 20357 HAMBURG, Tyskland (DE)

(55) Designavbildninger:

17.1



17.2



17.3



17.4

Design 18

- (54) **Produkt:** Adult toys
(51) **Klasse:** 28-03
(72) **Designer:** Paul Fally, Heinrich-Hertz-Strasse 37, 22085 HAMBURG, Tyskland (DE)
Johanna Königsberger, c/o Tiemann, Treskowstrasse 30, 20257 HAMBURG, Tyskland (DE)
Won-Gyung Lee, Boberger Strasse 17, 22111 HAMBURG, Tyskland (DE)
Jan Meissner, Rellinger Str. 18, 20257 HAMBURG, Tyskland (DE)
Tobias Schreier, Karolinenstr. 14, 20357 HAMBURG, Tyskland (DE)

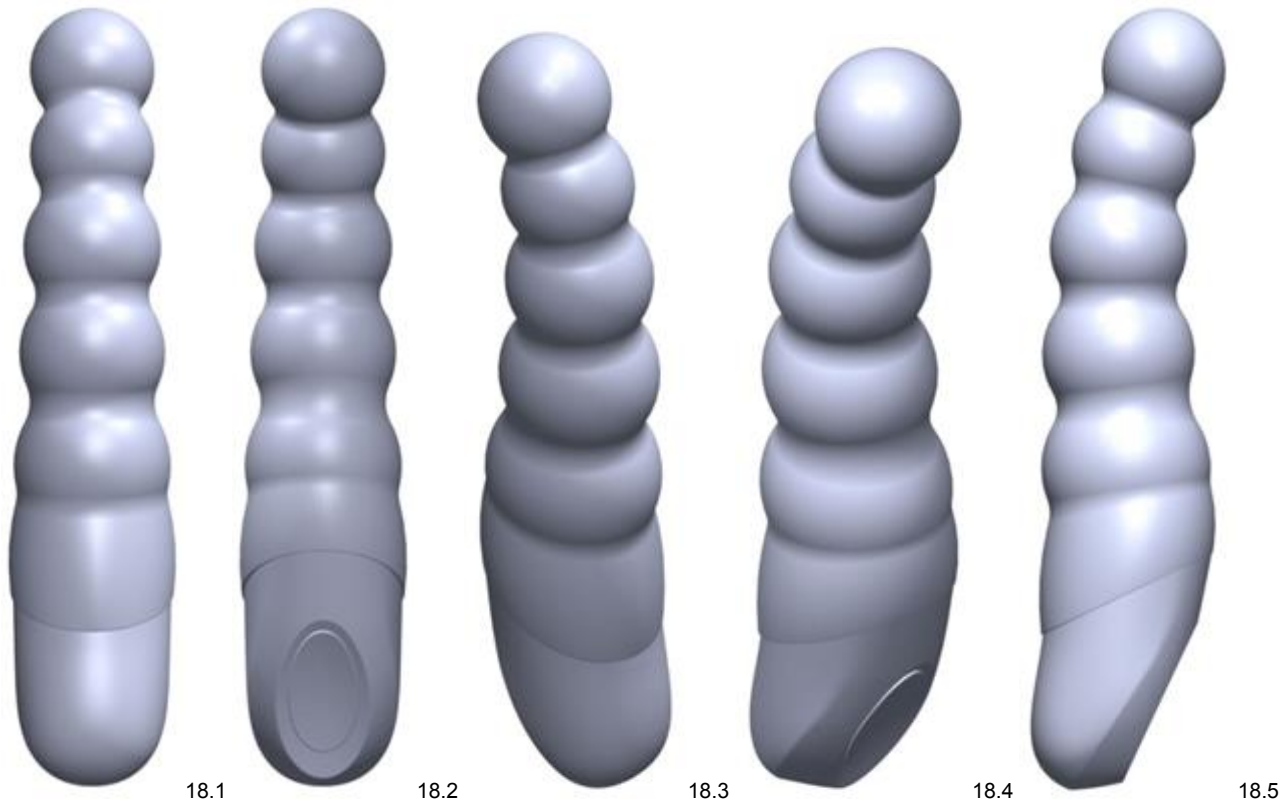
(55) Designavbildninger:**Design 19**

- (54) **Produkt:** Adult toys
(51) **Klasse:** 28-03
(72) **Designer:** Paul Fally, Heinrich-Hertz-Strasse 37, 22085 HAMBURG, Tyskland (DE)
Johanna Königsberger, c/o Tiemann, Treskowstrasse 30, 20257 HAMBURG, Tyskland (DE)
Won-Gyung Lee, Boberger Strasse 17, 22111 HAMBURG, Tyskland (DE)
Jan Meissner, Rellinger Str. 18, 20257 HAMBURG, Tyskland (DE)
Tobias Schreier, Karolinenstr. 14, 20357 HAMBURG, Tyskland (DE)

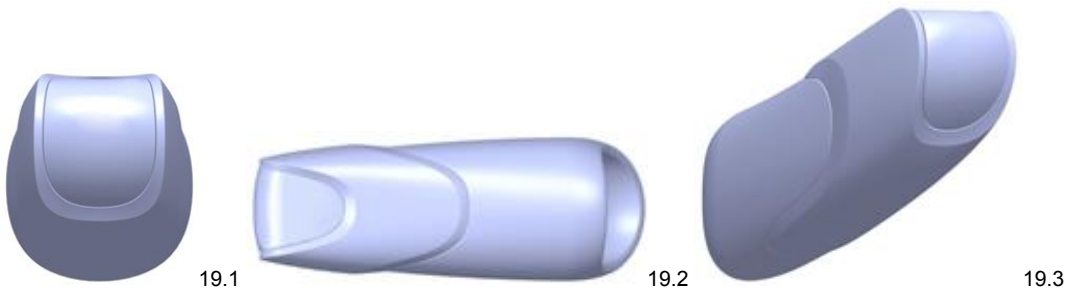
(55) Designavbildninger:

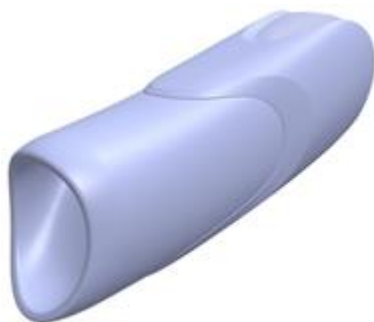

19.4

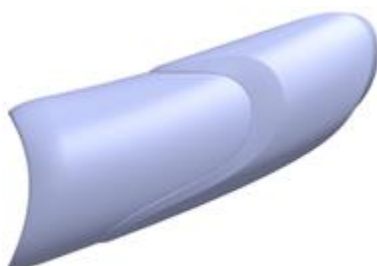

19.5

Design 20

- (54) **Produkt:**
(51) **Klasse:**
(72) **Designer:**

Adult toys

28-03

Paul Fally, Heinrich-Hertz-Strasse 37, 22085 HAMBURG, Tyskland (DE)

Johanna Königsberger, c/o Tiemann, Treskowstrasse 30, 20257 HAMBURG, Tyskland (DE)

Won-Gyung Lee, Boberger Strasse 17, 22111 HAMBURG, Tyskland (DE)

Jan Meissner, Rellinger Str. 18, 20257 HAMBURG, Tyskland (DE)

Tobias Schreier, Karolinenstr. 14, 20357 HAMBURG, Tyskland (DE)

- (55) **Designavbildninger:**



20.1



20.2



20.3



20.4



20.5



20.6

Design 21

- (54) **Produkt:** Adult toys
(51) **Klasse:** 28-03
(72) **Designer:** Paul Fally, Heinrich-Hertz-Strasse 37, 22085 HAMBURG, Tyskland (DE)
Johanna Königsberger, c/o Tiemann, Treskowstrasse 30, 20257 HAMBURG, Tyskland (DE)
Won-Gyung Lee, Boberger Strasse 17, 22111 HAMBURG, Tyskland (DE)
Jan Meissner, Rellinger Str. 18, 20257 HAMBURG, Tyskland (DE)
Tobias Schreier, Karolinenstr. 14, 20357 HAMBURG, Tyskland (DE)



21.1



21.2



21.3



21.4

Design 22

- (54) **Produkt:** Adult toys
 (51) **Klasse:** 28-03
 (72) **Designer:** Paul Fally, Heinrich-Hertz-Strasse 37, 22085 HAMBURG, Tyskland (DE)
 Johanna Königsberger, c/o Tiemann, Treskowstrasse 30, 20257 HAMBURG, Tyskland (DE)
 Won-Gyung Lee, Boberger Strasse 17, 22111 HAMBURG, Tyskland (DE)
 Jan Meissner, Rellinger Str. 18, 20257 HAMBURG, Tyskland (DE)
 Tobias Schreier, Karolinenstr. 14, 20357 HAMBURG, Tyskland (DE)

(55) **Designavbildninger:**

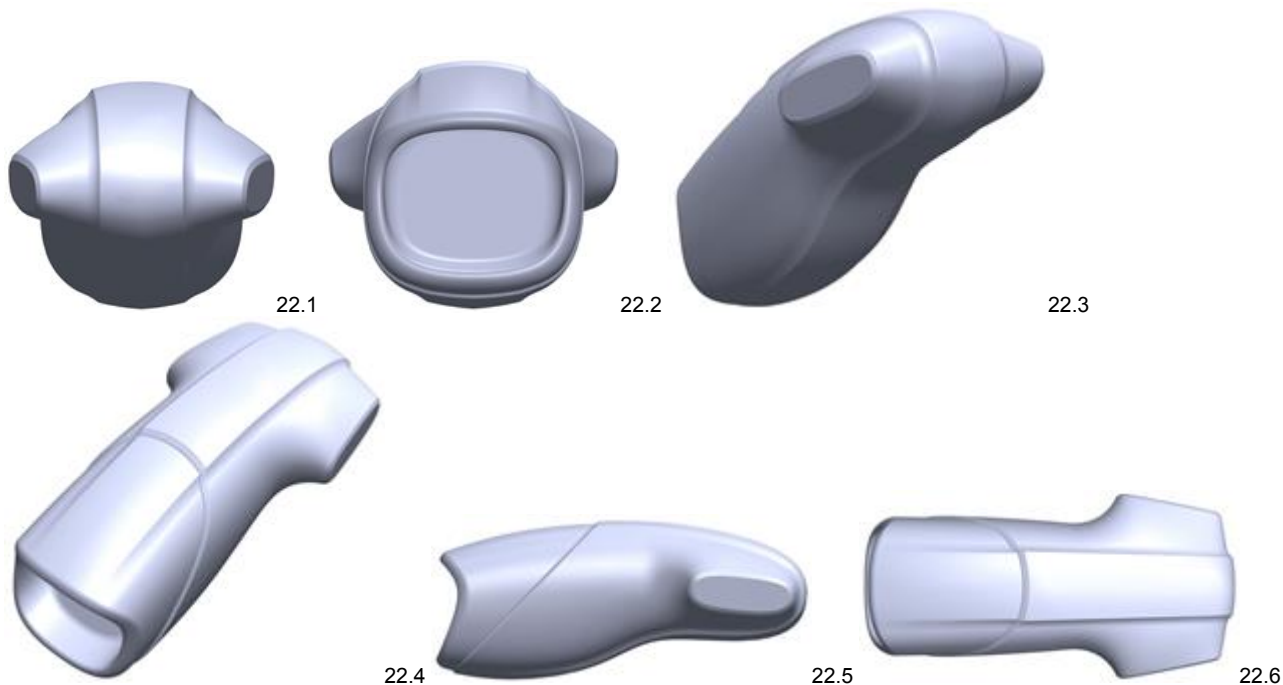
**Design 23**

- (54) **Produkt:** Adult toys
 (51) **Klasse:** 28-03
 (72) **Designer:** Paul Fally, Heinrich-Hertz-Strasse 37, 22085 HAMBURG, Tyskland (DE)
 Johanna Königsberger, c/o Tiemann, Treskowstrasse 30, 20257 HAMBURG, Tyskland (DE)
 Won-Gyung Lee, Boberger Strasse 17, 22111 HAMBURG, Tyskland (DE)
 Jan Meissner, Rellinger Str. 18, 20257 HAMBURG, Tyskland (DE)
 Tobias Schreier, Karolinenstr. 14, 20357 HAMBURG, Tyskland (DE)

(55) **Designavbildninger:**

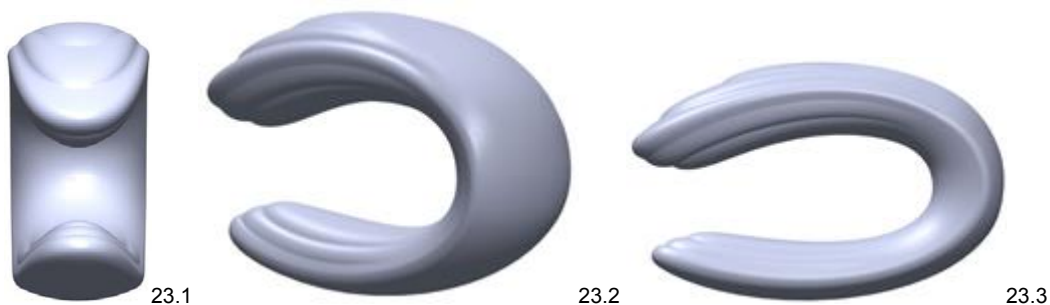

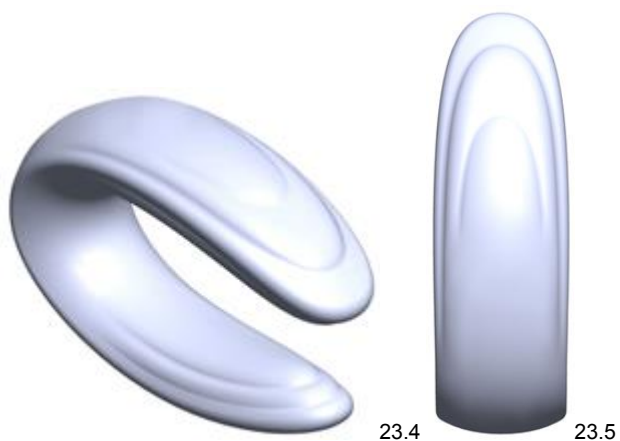
**Design 24**

(54) **Produkt:** Adult toys

(51) **Klasse:** 28-03

(72) **Designer:**

Paul Fally, Heinrich-Hertz-Strasse 37, 22085 HAMBURG, Tyskland (DE)
Johanna Königsberger, c/o Tiemann, Treskowstrasse 30, 20257 HAMBURG, Tyskland (DE)
Won-Gyung Lee, Boberger Strasse 17, 22111 HAMBURG, Tyskland (DE)
Jan Meissner, Rellinger Str. 18, 20257 HAMBURG, Tyskland (DE)
Tobias Schreier, Karolinenstr. 14, 20357 HAMBURG, Tyskland (DE)

(55) **Designavbildninger:**

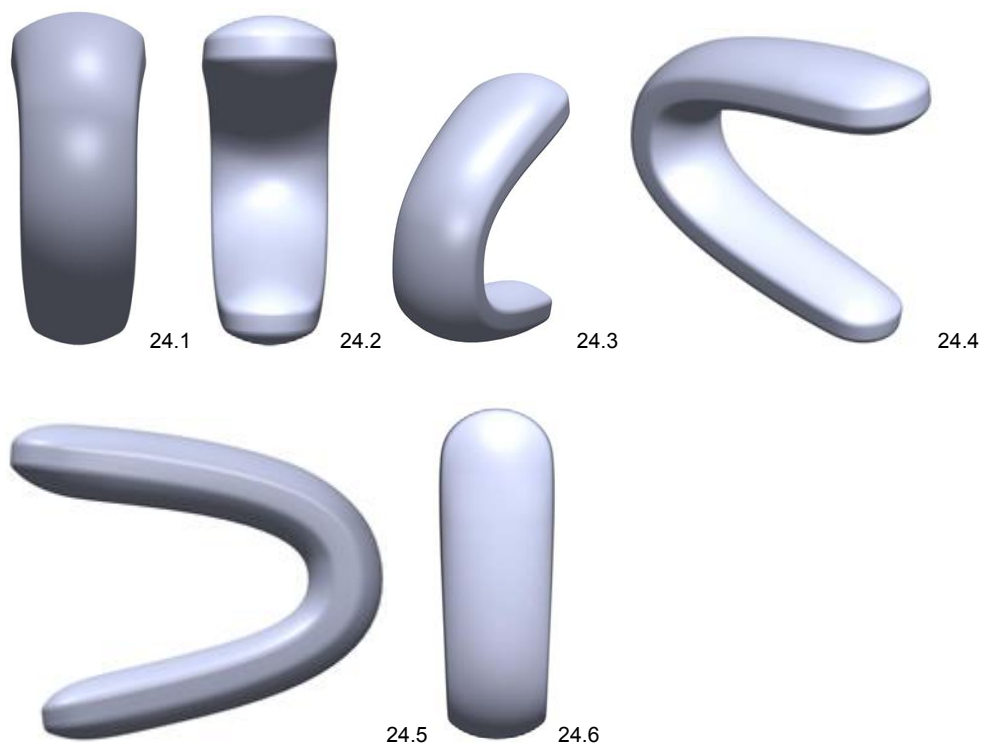

Design 25

- (54) **Produkt:** Adult toys
(51) **Klasse:** 28-03
(72) **Designer:** Paul Fally, Heinrich-Hertz-Strasse 37, 22085 HAMBURG, Tyskland (DE)
Johanna Königsberger, c/o Tiemann, Treskowstrasse 30, 20257 HAMBURG, Tyskland (DE)
Won-Gyung Lee, Boberger Strasse 17, 22111 HAMBURG, Tyskland (DE)
Jan Meissner, Rellinger Str. 18, 20257 HAMBURG, Tyskland (DE)
Tobias Schreier, Karolinenstr. 14, 20357 HAMBURG, Tyskland (DE)

(55) Designavbildninger:

25.1



25.2



25.3



25.4



25.5



25.6

Design 26

- (54) **Produkt:** Adult toys
(51) **Klasse:** 28-03
(72) **Designer:** Paul Fally, Heinrich-Hertz-Strasse 37, 22085 HAMBURG, Tyskland (DE)
Johanna Königsberger, c/o Tiemann, Treskowstrasse 30, 20257 HAMBURG, Tyskland (DE)
Won-Gyung Lee, Boberger Strasse 17, 22111 HAMBURG, Tyskland (DE)
Jan Meissner, Rellinger Str. 18, 20257 HAMBURG, Tyskland (DE)
Tobias Schreier, Karolinenstr. 14, 20357 HAMBURG, Tyskland (DE)

(55) Designavbildninger:

26.1



26.2



26.3



26.4



26.5



26.6

Design 27

- (54) **Produkt:** Adult toys
(51) **Klasse:** 28-03
(72) **Designer:** Paul Fally, Heinrich-Hertz-Strasse 37, 22085 HAMBURG, Tyskland (DE)
Johanna Königsberger, c/o Tiemann, Treskowstrasse 30, 20257 HAMBURG, Tyskland (DE)
Won-Gyung Lee, Boberger Strasse 17, 22111 HAMBURG, Tyskland (DE)
Jan Meissner, Rellinger Str. 18, 20257 HAMBURG, Tyskland (DE)
Tobias Schreier, Karolinenstr. 14, 20357 HAMBURG, Tyskland (DE)

(55) Designavbildninger:

27.1



27.2



27.3

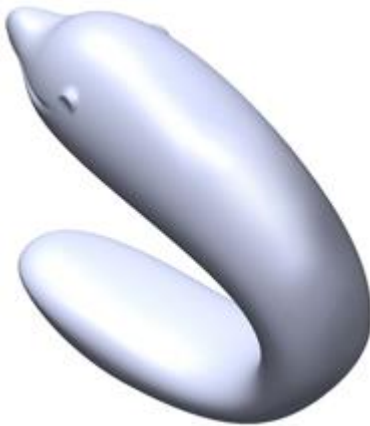

27.4



27.5



27.6

Design 28(54) **Produkt:** Adult toys(51) **Klasse:** 28-03(72) **Designer:**

Paul Fally, Heinrich-Hertz-Strasse 37, 22085 HAMBURG, Tyskland (DE)

Johanna Königsberger, c/o Tiemann, Treskowstrasse 30, 20257 HAMBURG, Tyskland (DE)

Won-Gyung Lee, Boberger Strasse 17, 22111 HAMBURG, Tyskland (DE)

Jan Meissner, Rellinger Str. 18, 20257 HAMBURG, Tyskland (DE)

Tobias Schreier, Karolinenstr. 14, 20357 HAMBURG, Tyskland (DE)

(55) **Designavbildninger:**

28.1



28.2



28.3



28.4



28.5



28.6

Design 29(54) **Produkt:** Adult toys(51) **Klasse:** 28-03(72) **Designer:**

Paul Fally, Heinrich-Hertz-Strasse 37, 22085 HAMBURG, Tyskland (DE)

Johanna Königsberger, c/o Tiemann, Treskowstrasse 30, 20257 HAMBURG, Tyskland (DE)

Won-Gyung Lee, Boberger Strasse 17, 22111 HAMBURG, Tyskland (DE)

Jan Meissner, Rellinger Str. 18, 20257 HAMBURG, Tyskland (DE)

Tobias Schreier, Karolinenstr. 14, 20357 HAMBURG, Tyskland (DE)

(55) **Designavbildninger:**

29.1



29.2



29.3

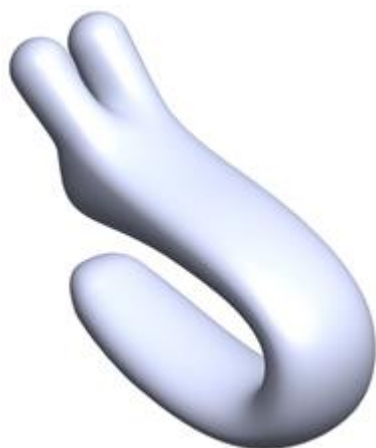

29.4



29.5



29.6

Design 30

(54) **Produkt:**
 (51) **Klasse:**
 (72) **Designer:**

Adult toys
 28-03

Paul Fally, Heinrich-Hertz-Strasse 37, 22085 HAMBURG, Tyskland (DE)

Johanna Königsberger, c/o Tiemann, Treskowstrasse 30, 20257 HAMBURG, Tyskland (DE)

Won-Gyung Lee, Boberger Strasse 17, 22111 HAMBURG, Tyskland (DE)

Jan Meissner, Rellinger Str. 18, 20257 HAMBURG, Tyskland (DE)

Tobias Schreier, Karolinenstr. 14, 20357 HAMBURG, Tyskland (DE)

(55) **Designavbildninger:**



30.1

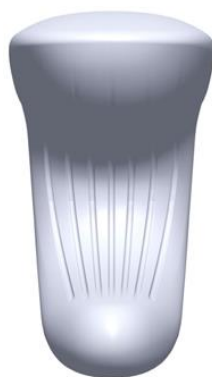

30.2



30.3



30.4



30.5

Design 31

- (54) **Produkt:** Adult toys
(51) **Klasse:** 28-03
(72) **Designer:** Paul Fally, Heinrich-Hertz-Strasse 37, 22085 HAMBURG, Tyskland (DE)
Johanna Königsberger, c/o Tiemann, Treskowstrasse 30, 20257 HAMBURG, Tyskland (DE)
Won-Gyung Lee, Boberger Strasse 17, 22111 HAMBURG, Tyskland (DE)
Jan Meissner, Rellinger Str. 18, 20257 HAMBURG, Tyskland (DE)
Tobias Schreier, Karolinenstr. 14, 20357 HAMBURG, Tyskland (DE)

(55) **Designavbildninger:**

31.1



31.2



31.3



31.4



31.5

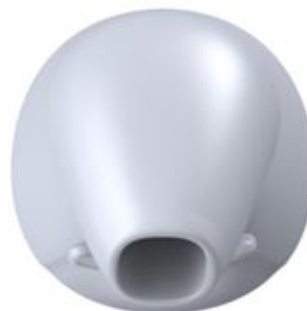

31.6

Design 32

- (54) **Produkt:** Adult toys
(51) **Klasse:** 28-03
(72) **Designer:** Paul Fally, Heinrich-Hertz-Strasse 37, 22085 HAMBURG, Tyskland (DE)
Johanna Königsberger, c/o Tiemann, Treskowstrasse 30, 20257 HAMBURG, Tyskland (DE)
Won-Gyung Lee, Boberger Strasse 17, 22111 HAMBURG, Tyskland (DE)
Jan Meissner, Rellinger Str. 18, 20257 HAMBURG, Tyskland (DE)
Tobias Schreier, Karolinenstr. 14, 20357 HAMBURG, Tyskland (DE)

(55) Designavbildninger:

32.1



32.2



32.3



32.4



32.5



32.6

Design 33

(54) **Produkt:** Adult toys

(51) **Klasse:** 28-03

(72) **Designer:**

Paul Fally, Heinrich-Hertz-Strasse 37, 22085 HAMBURG, Tyskland (DE)

Johanna Königsberger, c/o Tiemann, Treskowstrasse 30, 20257 HAMBURG, Tyskland (DE)

Won-Gyung Lee, Boberger Strasse 17, 22111 HAMBURG, Tyskland (DE)

Jan Meissner, Rellinger Str. 18, 20257 HAMBURG, Tyskland (DE)

Tobias Schreier, Karolinenstr. 14, 20357 HAMBURG, Tyskland (DE)

(55) **Designavbildninger:**



33.1



33.2



33.3



33.4

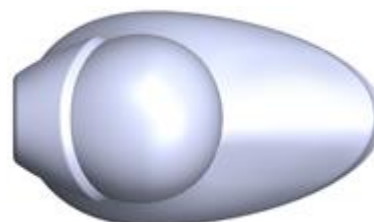

33.5



33.6

Design 34

- (54) **Produkt:** Adult toys
(51) **Klasse:** 28-03
(72) **Designer:** Paul Fally, Heinrich-Hertz-Strasse 37, 22085 HAMBURG, Tyskland (DE)
Johanna Königsberger, c/o Tiemann, Treskowstrasse 30, 20257 HAMBURG, Tyskland (DE)
Won-Gyung Lee, Boberger Strasse 17, 22111 HAMBURG, Tyskland (DE)
Jan Meissner, Rellinger Str. 18, 20257 HAMBURG, Tyskland (DE)
Tobias Schreier, Karolinenstr. 14, 20357 HAMBURG, Tyskland (DE)

(55) Designavbildninger:

34.1



34.2



34.3



34.4



34.5

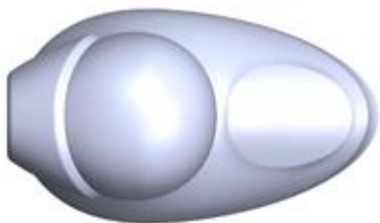

34.6

Design 35

- (54) **Produkt:** Adult toys
(51) **Klasse:** 28-03
(72) **Designer:** Paul Fally, Heinrich-Hertz-Strasse 37, 22085 HAMBURG, Tyskland (DE)
Johanna Königsberger, c/o Tiemann, Treskowstrasse 30, 20257 HAMBURG, Tyskland (DE)
Won-Gyung Lee, Boberger Strasse 17, 22111 HAMBURG, Tyskland (DE)
Jan Meissner, Rellinger Str. 18, 20257 HAMBURG, Tyskland (DE)
Tobias Schreier, Karolinenstr. 14, 20357 HAMBURG, Tyskland (DE)

(55) Designavbildninger:

35.1



35.2

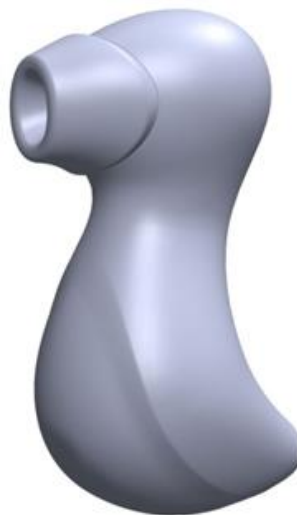

35.3

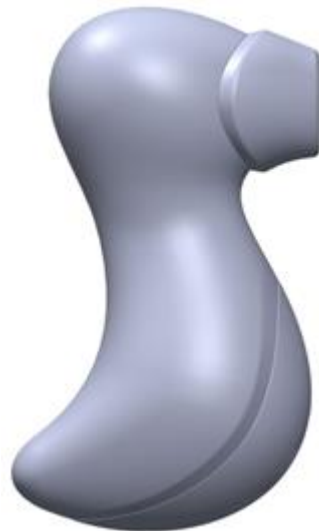

35.4

Design 36

- (54) **Produkt:** Adult toys
(51) **Klasse:** 28-03
(72) **Designer:** Paul Fally, Heinrich-Hertz-Strasse 37, 22085 HAMBURG, Tyskland (DE)
Johanna Königsberger, c/o Tiemann, Treskowstrasse 30, 20257 HAMBURG, Tyskland (DE)
Won-Gyung Lee, Boberger Strasse 17, 22111 HAMBURG, Tyskland (DE)
Jan Meissner, Rellinger Str. 18, 20257 HAMBURG, Tyskland (DE)
Tobias Schreier, Karolinenstr. 14, 20357 HAMBURG, Tyskland (DE)

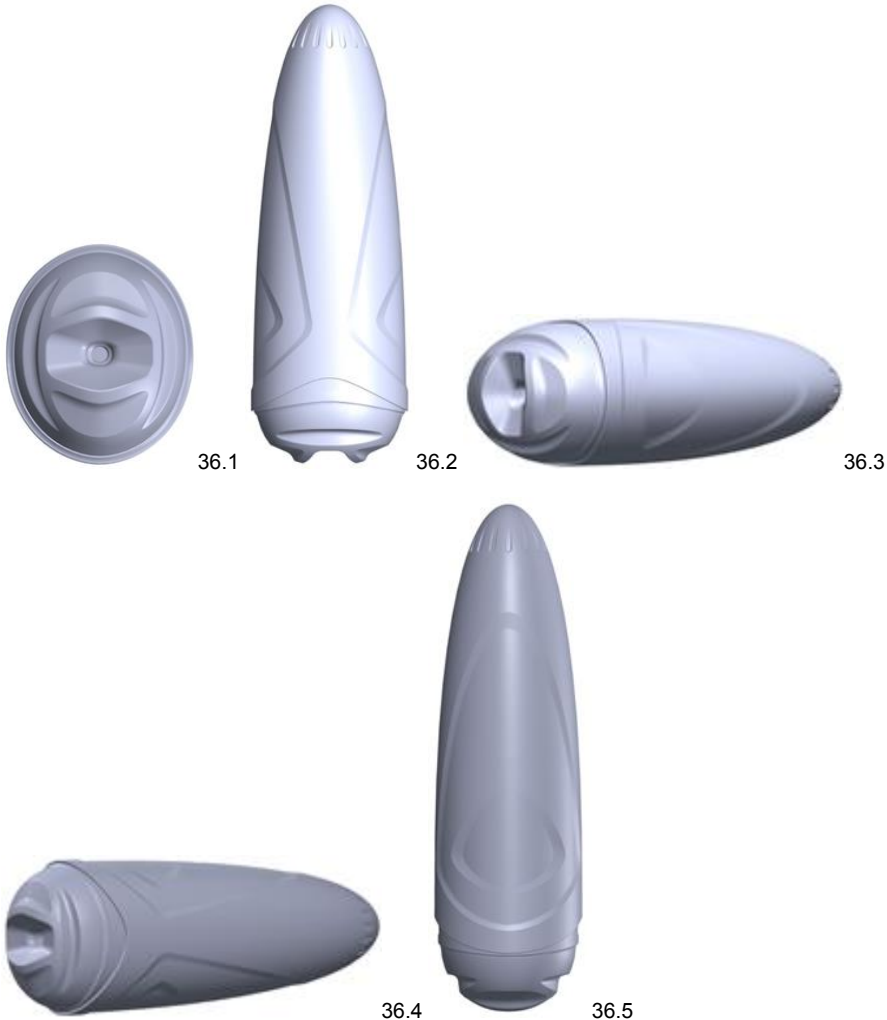
(55) Designavbildninger:

Design 37

- (54) **Produkt:** Adult toys
(51) **Klasse:** 28-03
(72) **Designer:** Paul Fally, Heinrich-Hertz-Strasse 37, 22085 HAMBURG, Tyskland (DE)
Johanna Königsberger, c/o Tiemann, Treskowstrasse 30, 20257 HAMBURG, Tyskland (DE)
Won-Gyung Lee, Boberger Strasse 17, 22111 HAMBURG, Tyskland (DE)
Jan Meissner, Rellinger Str. 18, 20257 HAMBURG, Tyskland (DE)
Tobias Schreier, Karolinenstr. 14, 20357 HAMBURG, Tyskland (DE)

(55) **Designavbildninger:**

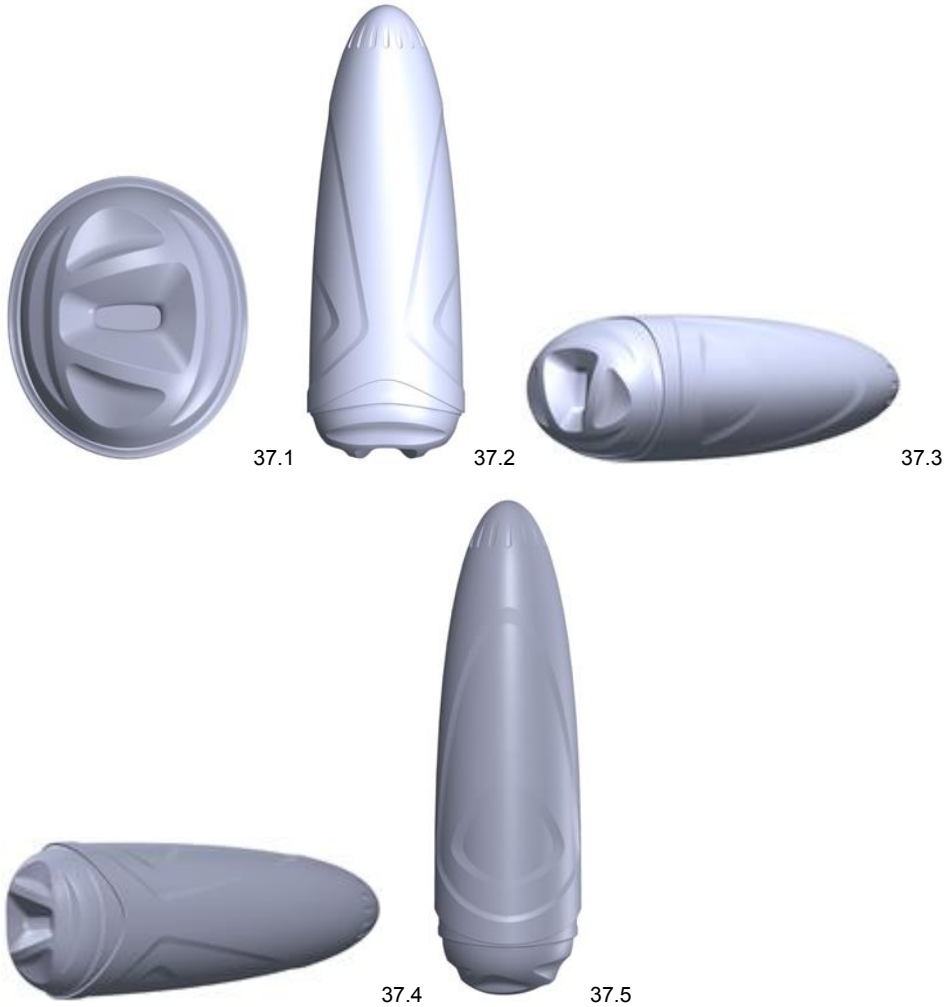

Design 38

- (54) **Produkt:** Adult toys
(51) **Klasse:** 28-03
(72) **Designer:** Paul Fally, Heinrich-Hertz-Strasse 37, 22085 HAMBURG, Tyskland (DE)
Johanna Königsberger, c/o Tiemann, Treskowstrasse 30, 20257 HAMBURG, Tyskland (DE)
Won-Gyung Lee, Boberger Strasse 17, 22111 HAMBURG, Tyskland (DE)
Jan Meissner, Rellinger Str. 18, 20257 HAMBURG, Tyskland (DE)
Tobias Schreier, Karolinenstr. 14, 20357 HAMBURG, Tyskland (DE)

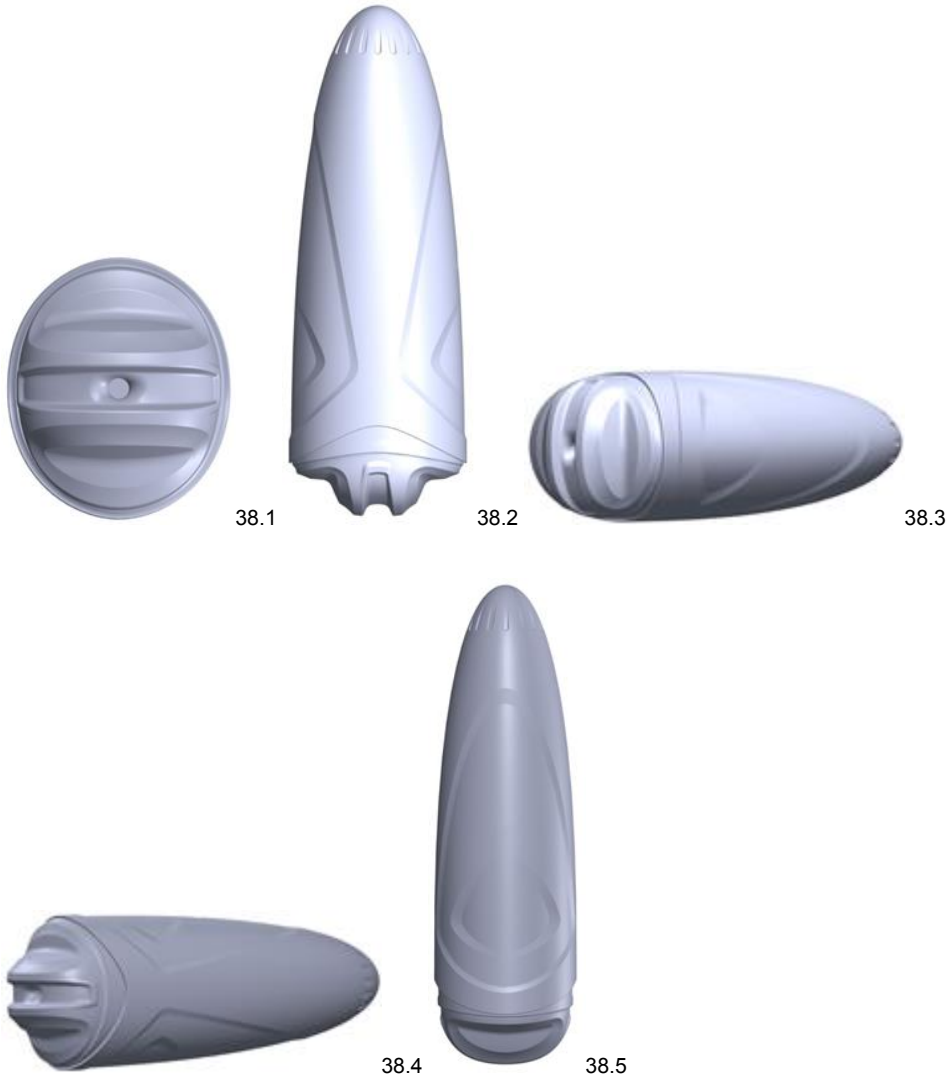
(55) Designavbildninger:

Design 39

(54) **Produkt:** Adult toys
 (51) **Klasse:** 28-03
 (72) **Designer:**

Paul Fally, Heinrich-Hertz-Strasse 37, 22085 HAMBURG, Tyskland (DE)
 Johanna Königsberger, c/o Tiemann, Treskowstrasse 30, 20257 HAMBURG, Tyskland (DE)
 Won-Gyung Lee, Boberger Strasse 17, 22111 HAMBURG, Tyskland (DE)
 Jan Meissner, Rellinger Str. 18, 20257 HAMBURG, Tyskland (DE)
 Tobias Schreier, Karolinenstr. 14, 20357 HAMBURG, Tyskland (DE)

(55) **Designavbildninger:**

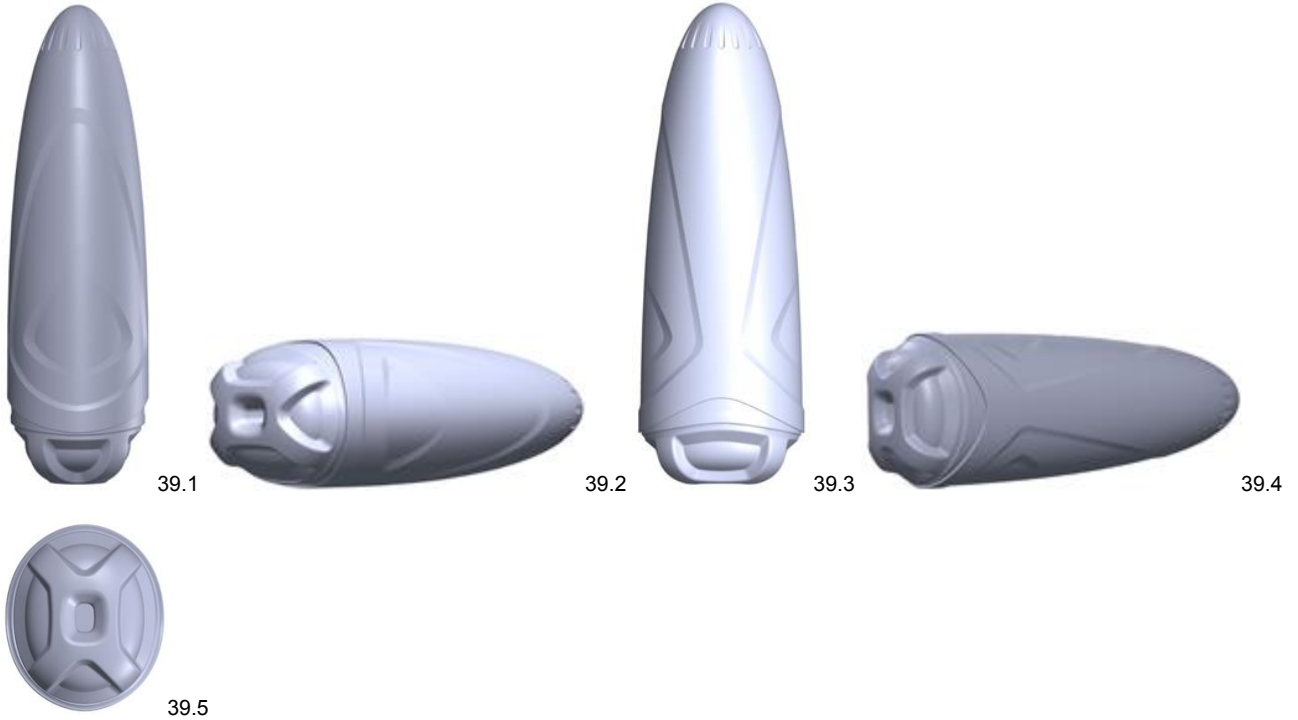
**Design 40**

(54) **Produkt:** Adult toys
 (51) **Klasse:** 28-03
 (72) **Designer:**

Paul Fally, Heinrich-Hertz-Strasse 37, 22085 HAMBURG, Tyskland (DE)
 Johanna Königsberger, c/o Tiemann, Treskowstrasse 30, 20257 HAMBURG, Tyskland (DE)
 Won-Gyung Lee, Boberger Strasse 17, 22111 HAMBURG, Tyskland (DE)
 Jan Meissner, Rellinger Str. 18, 20257 HAMBURG, Tyskland (DE)
 Tobias Schreier, Karolinenstr. 14, 20357 HAMBURG, Tyskland (DE)

(55) **Designavbildninger:**

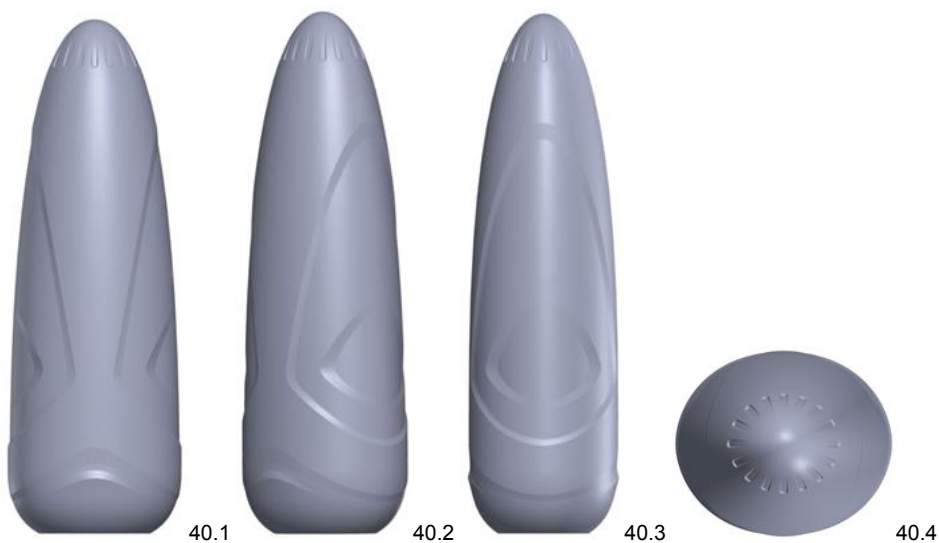

Design 41

- (54) **Produkt:** Adult toys
(51) **Klasse:** 28-03
(72) **Designer:** Paul Fally, Heinrich-Hertz-Strasse 37, 22085 HAMBURG, Tyskland (DE)
Johanna Königsberger, c/o Tiemann, Treskowstrasse 30, 20257 HAMBURG, Tyskland (DE)
Won-Gyung Lee, Boberger Strasse 17, 22111 HAMBURG, Tyskland (DE)
Jan Meissner, Rellinger Str. 18, 20257 HAMBURG, Tyskland (DE)
Tobias Schreier, Karolinenstr. 14, 20357 HAMBURG, Tyskland (DE)

(55) Designavbildninger:

41.1



41.2



41.3



41.4



41.5



41.6

Design 42

- (54) **Produkt:** Adult toys
(51) **Klasse:** 28-03
(72) **Designer:** Paul Fally, Heinrich-Hertz-Strasse 37, 22085 HAMBURG, Tyskland (DE)
Johanna Königsberger, c/o Tiemann, Treskowstrasse 30, 20257 HAMBURG, Tyskland (DE)
Won-Gyung Lee, Boberger Strasse 17, 22111 HAMBURG, Tyskland (DE)
Jan Meissner, Rellinger Str. 18, 20257 HAMBURG, Tyskland (DE)
Tobias Schreier, Karolinenstr. 14, 20357 HAMBURG, Tyskland (DE)

(55) Designavbildninger:

42.1



42.2



42.3



42.4



42.5



42.6

Design 43

- (54) **Produkt:** Adult toys
(51) **Klasse:** 28-03
(72) **Designer:** Paul Fally, Heinrich-Hertz-Strasse 37, 22085 HAMBURG, Tyskland (DE)
Johanna Königsberger, c/o Tiemann, Treskowstrasse 30, 20257 HAMBURG, Tyskland (DE)
Won-Gyung Lee, Boberger Strasse 17, 22111 HAMBURG, Tyskland (DE)
Jan Meissner, Rellinger Str. 18, 20257 HAMBURG, Tyskland (DE)
Tobias Schreier, Karolinenstr. 14, 20357 HAMBURG, Tyskland (DE)

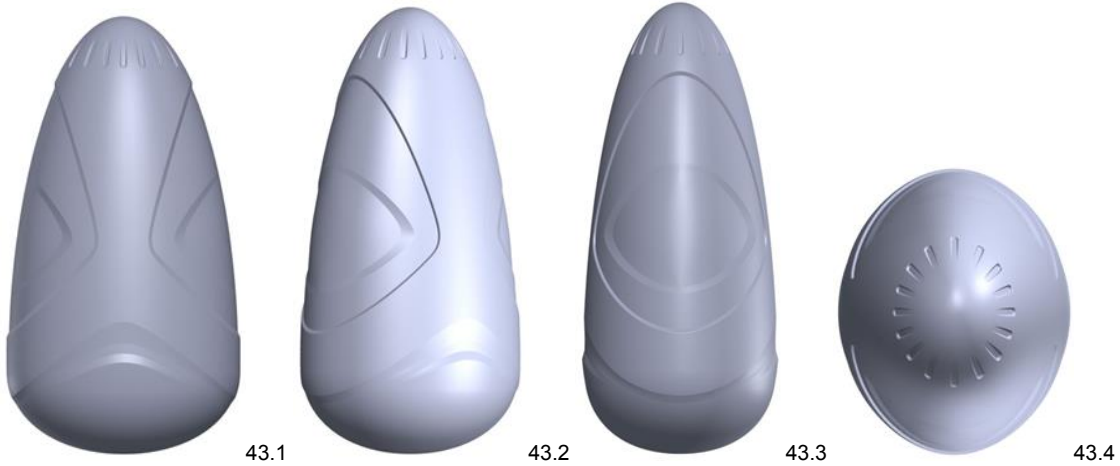
(55) Designavbildninger:**Design 44**

- (54) **Produkt:** Adult toys
(51) **Klasse:** 28-03
(72) **Designer:** Paul Fally, Heinrich-Hertz-Strasse 37, 22085 HAMBURG, Tyskland (DE)
Johanna Königsberger, c/o Tiemann, Treskowstrasse 30, 20257 HAMBURG, Tyskland (DE)
Won-Gyung Lee, Boberger Strasse 17, 22111 HAMBURG, Tyskland (DE)
Jan Meissner, Rellinger Str. 18, 20257 HAMBURG, Tyskland (DE)
Tobias Schreier, Karolinenstr. 14, 20357 HAMBURG, Tyskland (DE)

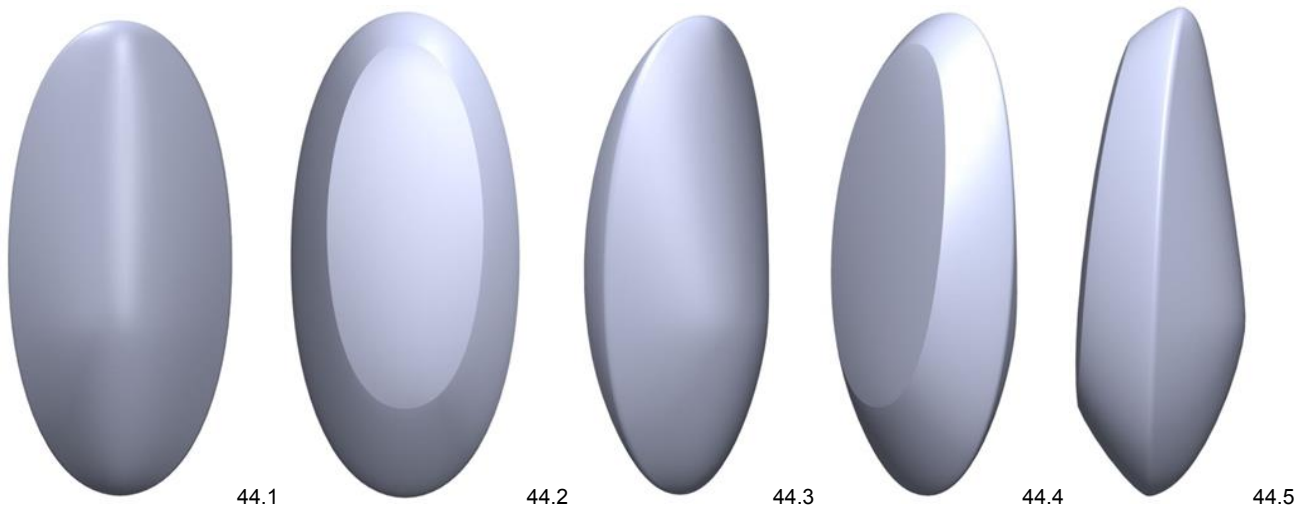
(55) Designavbildninger:

Design 45

- (54) **Produkt:** Adult toys
(51) **Klasse:** 28-03
(72) **Designer:** Paul Fally, Heinrich-Hertz-Strasse 37, 22085 HAMBURG, Tyskland (DE)
Johanna Königsberger, c/o Tiemann, Treskowstrasse 30, 20257 HAMBURG, Tyskland (DE)
Won-Gyung Lee, Boberger Strasse 17, 22111 HAMBURG, Tyskland (DE)
Jan Meissner, Rellinger Str. 18, 20257 HAMBURG, Tyskland (DE)
Tobias Schreier, Karolinenstr. 14, 20357 HAMBURG, Tyskland (DE)

(55) Designavbildninger:

45.1



45.2



45.3



45.4



45.5

Design 46

- (54) **Produkt:** Adult toys
(51) **Klasse:** 28-03
(72) **Designer:** Paul Fally, Heinrich-Hertz-Strasse 37, 22085 HAMBURG, Tyskland (DE)
Johanna Königsberger, c/o Tiemann, Treskowstrasse 30, 20257 HAMBURG, Tyskland (DE)
Won-Gyung Lee, Boberger Strasse 17, 22111 HAMBURG, Tyskland (DE)
Jan Meissner, Rellinger Str. 18, 20257 HAMBURG, Tyskland (DE)
Tobias Schreier, Karolinenstr. 14, 20357 HAMBURG, Tyskland (DE)

(55) Designavbildninger:

46.1



46.2



46.3



46.4



46.5

Design 47

- (54) **Produkt:** Adult toys
(51) **Klasse:** 28-03
(72) **Designer:** Paul Fally, Heinrich-Hertz-Strasse 37, 22085 HAMBURG, Tyskland (DE)
Johanna Königsberger, c/o Tiemann, Treskowstrasse 30, 20257 HAMBURG, Tyskland (DE)
Won-Gyung Lee, Boberger Strasse 17, 22111 HAMBURG, Tyskland (DE)
Jan Meissner, Rellinger Str. 18, 20257 HAMBURG, Tyskland (DE)
Tobias Schreier, Karolinenstr. 14, 20357 HAMBURG, Tyskland (DE)

(55) Designavbildninger:

47.1



47.2



47.3



47.4



47.5

Design 48

- (54) **Produkt:** Adult toys
(51) **Klasse:** 28-03
(72) **Designer:** Paul Fally, Heinrich-Hertz-Strasse 37, 22085 HAMBURG, Tyskland (DE)
Johanna Königsberger, c/o Tiemann, Treskowstrasse 30, 20257 HAMBURG, Tyskland (DE)
Won-Gyung Lee, Boberger Strasse 17, 22111 HAMBURG, Tyskland (DE)
Jan Meissner, Rellinger Str. 18, 20257 HAMBURG, Tyskland (DE)
Tobias Schreier, Karolinenstr. 14, 20357 HAMBURG, Tyskland (DE)

(55) Designavbildninger:

48.1



48.2



48.3



48.4



48.5

Design 49

- (54) **Produkt:** Adult toys
(51) **Klasse:** 28-03
(72) **Designer:** Paul Fally, Heinrich-Hertz-Strasse 37, 22085 HAMBURG, Tyskland (DE)
Johanna Königsberger, c/o Tiemann, Treskowstrasse 30, 20257 HAMBURG, Tyskland (DE)
Won-Gyung Lee, Boberger Strasse 17, 22111 HAMBURG, Tyskland (DE)
Jan Meissner, Rellinger Str. 18, 20257 HAMBURG, Tyskland (DE)
Tobias Schreier, Karolinenstr. 14, 20357 HAMBURG, Tyskland (DE)

(55) Designavbildninger:

49.1



49.2



49.3



49.4

Design 50

- (54) **Produkt:** Adult toys
(51) **Klasse:** 28-03
(72) **Designer:** Paul Fally, Heinrich-Hertz-Strasse 37, 22085 HAMBURG, Tyskland (DE)
Johanna Königsberger, c/o Tiemann, Treskowstrasse 30, 20257 HAMBURG, Tyskland (DE)
Won-Gyung Lee, Boberger Strasse 17, 22111 HAMBURG, Tyskland (DE)
Jan Meissner, Rellinger Str. 18, 20257 HAMBURG, Tyskland (DE)
Tobias Schreier, Karolinenstr. 14, 20357 HAMBURG, Tyskland (DE)

(55) Designavbildninger:

50.1



50.2



50.3



50.4

Design 51

- (54) **Produkt:** Adult toys
(51) **Klasse:** 28-03
(72) **Designer:** Paul Fally, Heinrich-Hertz-Strasse 37, 22085 HAMBURG, Tyskland (DE)
Johanna Königsberger, c/o Tiemann, Treskowstrasse 30, 20257 HAMBURG, Tyskland (DE)
Won-Gyung Lee, Boberger Strasse 17, 22111 HAMBURG, Tyskland (DE)
Jan Meissner, Rellinger Str. 18, 20257 HAMBURG, Tyskland (DE)
Tobias Schreier, Karolinenstr. 14, 20357 HAMBURG, Tyskland (DE)

(55) Designavbildninger:

51.1



51.2



51.3



51.4



51.5

Design 52

- (54) **Produkt:** Adult toys
(51) **Klasse:** 28-03
(72) **Designer:** Paul Fally, Heinrich-Hertz-Strasse 37, 22085 HAMBURG, Tyskland (DE)
Johanna Königsberger, c/o Tiemann, Treskowstrasse 30, 20257 HAMBURG, Tyskland (DE)
Won-Gyung Lee, Boberger Strasse 17, 22111 HAMBURG, Tyskland (DE)
Jan Meissner, Rellinger Str. 18, 20257 HAMBURG, Tyskland (DE)
Tobias Schreier, Karolinenstr. 14, 20357 HAMBURG, Tyskland (DE)

(55) Designavbildninger:

52.1



52.2



52.3



52.4



52.5

Design 53

- (54) **Produkt:** Adult toys
(51) **Klasse:** 28-03
(72) **Designer:** Paul Fally, Heinrich-Hertz-Strasse 37, 22085 HAMBURG, Tyskland (DE)
Johanna Königsberger, c/o Tiemann, Treskowstrasse 30, 20257 HAMBURG, Tyskland (DE)
Won-Gyung Lee, Boberger Strasse 17, 22111 HAMBURG, Tyskland (DE)
Jan Meissner, Rellinger Str. 18, 20257 HAMBURG, Tyskland (DE)
Tobias Schreier, Karolinenstr. 14, 20357 HAMBURG, Tyskland (DE)

(55) Designavbildninger:

53.1



53.2



53.3



53.4



53.5

Design 54

- (54) **Produkt:** Adult toys
(51) **Klasse:** 28-03
(72) **Designer:** Paul Fally, Heinrich-Hertz-Strasse 37, 22085 HAMBURG, Tyskland (DE)
Johanna Königsberger, c/o Tiemann, Treskowstrasse 30, 20257 HAMBURG, Tyskland (DE)
Won-Gyung Lee, Boberger Strasse 17, 22111 HAMBURG, Tyskland (DE)
Jan Meissner, Rellinger Str. 18, 20257 HAMBURG, Tyskland (DE)
Tobias Schreier, Karolinenstr. 14, 20357 HAMBURG, Tyskland (DE)

(55) Designavbildninger:

54.1



54.2



54.3



54.4



54.5

Design 55

- (54) **Produkt:** Adult toys
(51) **Klasse:** 28-03
(72) **Designer:** Paul Fally, Heinrich-Hertz-Strasse 37, 22085 HAMBURG, Tyskland (DE)
Johanna Königsberger, c/o Tiemann, Treskowstrasse 30, 20257 HAMBURG, Tyskland (DE)
Won-Gyung Lee, Boberger Strasse 17, 22111 HAMBURG, Tyskland (DE)
Jan Meissner, Rellinger Str. 18, 20257 HAMBURG, Tyskland (DE)
Tobias Schreier, Karolinenstr. 14, 20357 HAMBURG, Tyskland (DE)

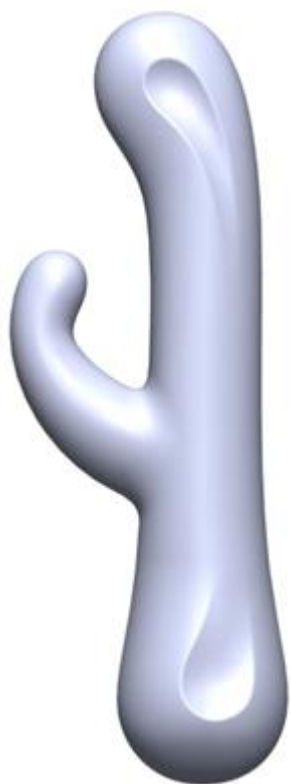
(55) Designavbildninger:

55.1



55.2

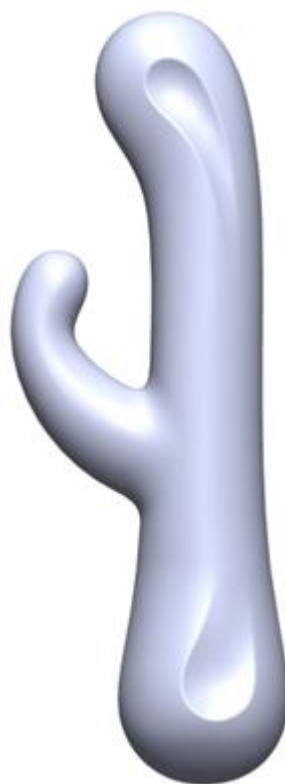

55.3



55.4



55.5



55.6

Design 56

- (54) **Produkt:** Adult toys
(51) **Klasse:** 28-03
(72) **Designer:** Paul Fally, Heinrich-Hertz-Strasse 37, 22085 HAMBURG, Tyskland (DE)
Johanna Königsberger, c/o Tiemann, Treskowstrasse 30, 20257 HAMBURG, Tyskland (DE)
Won-Gyung Lee, Boberger Strasse 17, 22111 HAMBURG, Tyskland (DE)
Jan Meissner, Rellinger Str. 18, 20257 HAMBURG, Tyskland (DE)
Tobias Schreier, Karolinenstr. 14, 20357 HAMBURG, Tyskland (DE)

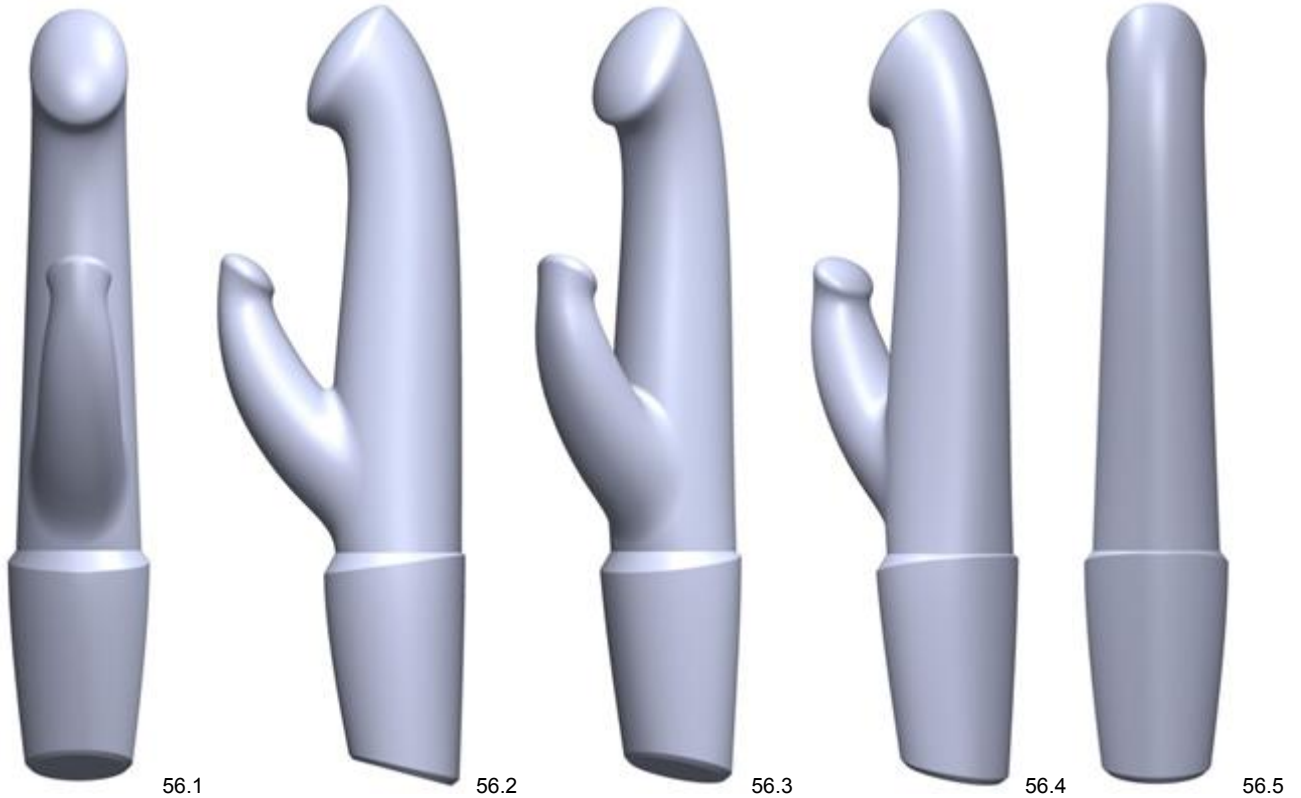
(55) Designavbildninger:

Design 57

- (54) **Produkt:** Adult toys
(51) **Klasse:** 28-03
(72) **Designer:** Paul Fally, Heinrich-Hertz-Strasse 37, 22085 HAMBURG, Tyskland (DE)
Johanna Königsberger, c/o Tiemann, Treskowstrasse 30, 20257 HAMBURG, Tyskland (DE)
Won-Gyung Lee, Boberger Strasse 17, 22111 HAMBURG, Tyskland (DE)
Jan Meissner, Rellinger Str. 18, 20257 HAMBURG, Tyskland (DE)
Tobias Schreier, Karolinenstr. 14, 20357 HAMBURG, Tyskland (DE)

(55) Designavbildninger:

57.1



57.2



57.3



57.4



57.5

Design 58

- (54) **Produkt:** Adult toys
(51) **Klasse:** 28-03
(72) **Designer:** Paul Fally, Heinrich-Hertz-Strasse 37, 22085 HAMBURG, Tyskland (DE)
Johanna Königsberger, c/o Tiemann, Treskowstrasse 30, 20257 HAMBURG, Tyskland (DE)
Won-Gyung Lee, Boberger Strasse 17, 22111 HAMBURG, Tyskland (DE)
Jan Meissner, Rellinger Str. 18, 20257 HAMBURG, Tyskland (DE)
Tobias Schreier, Karolinenstr. 14, 20357 HAMBURG, Tyskland (DE)

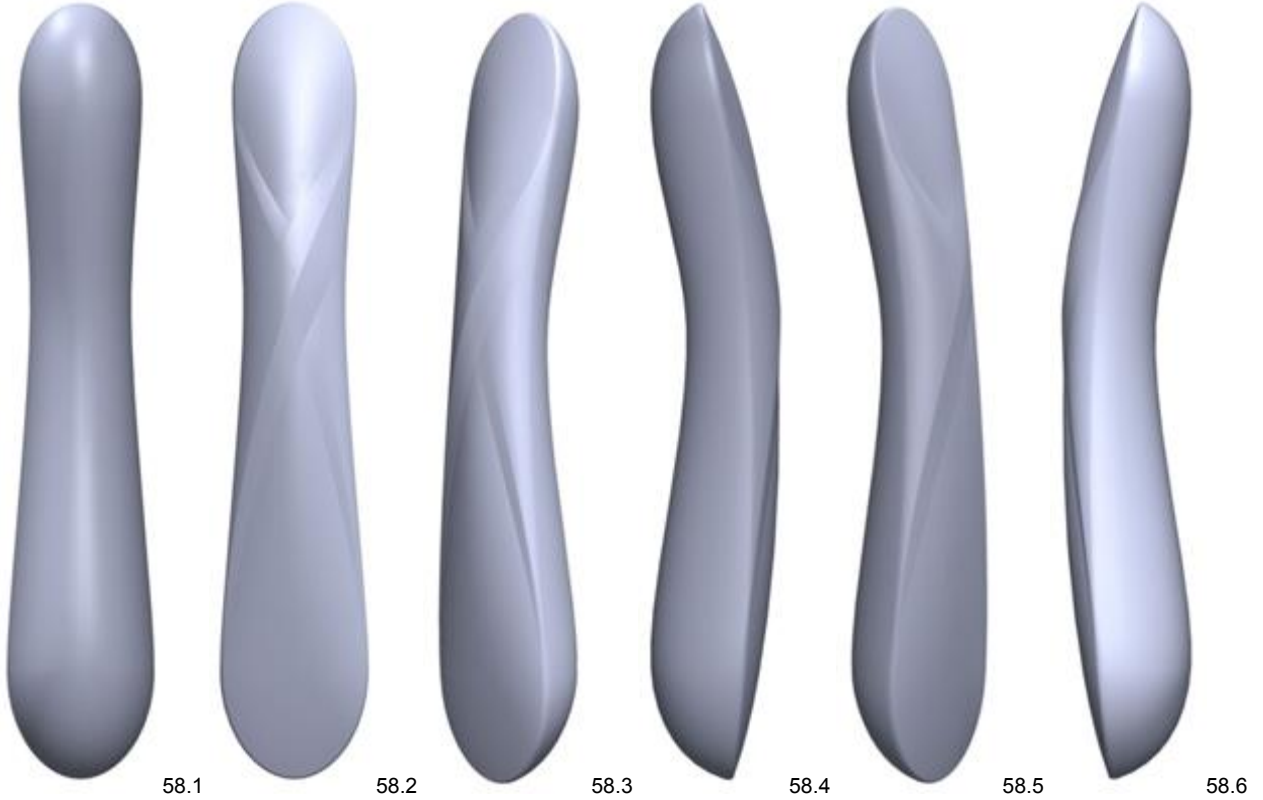
(55) Designavbildninger:

Design 59

- (54) **Produkt:** Adult toys
(51) **Klasse:** 28-03
(72) **Designer:** Paul Fally, Heinrich-Hertz-Strasse 37, 22085 HAMBURG, Tyskland (DE)
Johanna Königsberger, c/o Tiemann, Treskowstrasse 30, 20257 HAMBURG, Tyskland (DE)
Won-Gyung Lee, Boberger Strasse 17, 22111 HAMBURG, Tyskland (DE)
Jan Meissner, Rellinger Str. 18, 20257 HAMBURG, Tyskland (DE)
Tobias Schreier, Karolinenstr. 14, 20357 HAMBURG, Tyskland (DE)

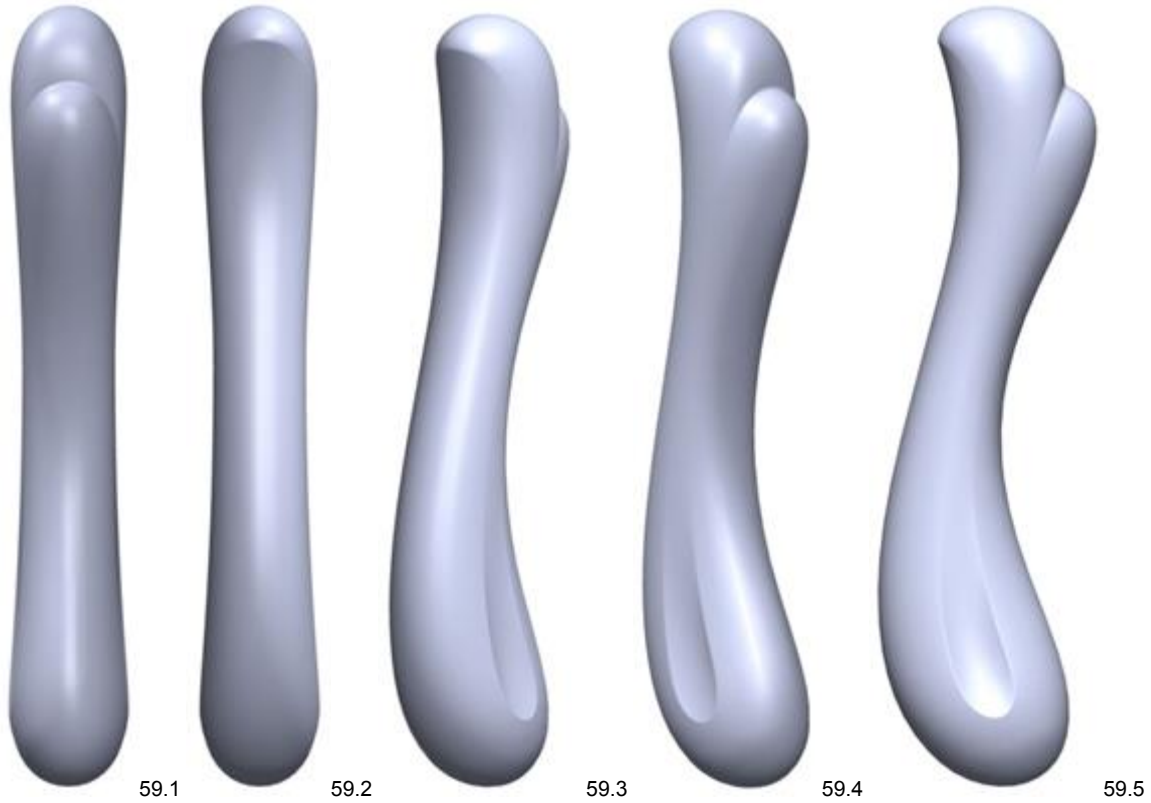
(55) Designavbildninger:

Design 60

- (54) **Produkt:** Adult toys
(51) **Klasse:** 28-03
(72) **Designer:** Paul Fally, Heinrich-Hertz-Strasse 37, 22085 HAMBURG, Tyskland (DE)
Johanna Königsberger, c/o Tiemann, Treskowstrasse 30, 20257 HAMBURG, Tyskland (DE)
Won-Gyung Lee, Boberger Strasse 17, 22111 HAMBURG, Tyskland (DE)
Jan Meissner, Rellinger Str. 18, 20257 HAMBURG, Tyskland (DE)
Tobias Schreier, Karolinenstr. 14, 20357 HAMBURG, Tyskland (DE)

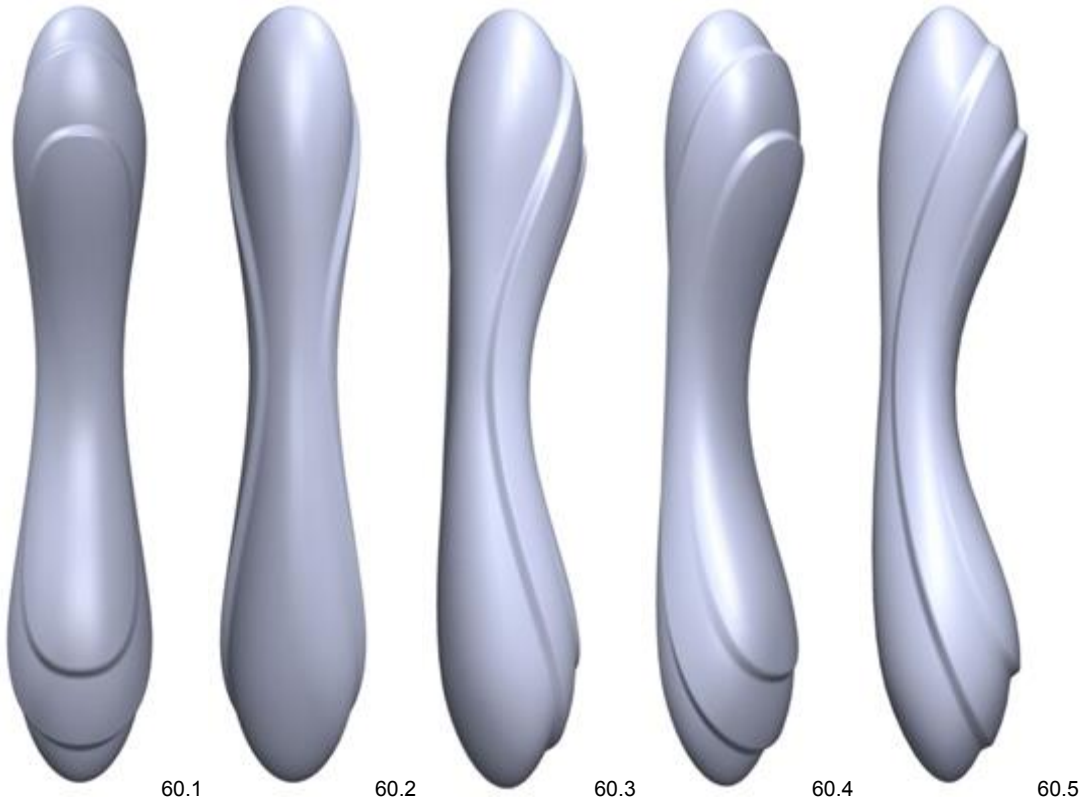
(55) Designavbildninger:

Design 61

- (54) **Produkt:** Adult toys
(51) **Klasse:** 28-03
(72) **Designer:** Paul Fally, Heinrich-Hertz-Strasse 37, 22085 HAMBURG, Tyskland (DE)
Johanna Königsberger, c/o Tiemann, Treskowstrasse 30, 20257 HAMBURG, Tyskland (DE)
Won-Gyung Lee, Boberger Strasse 17, 22111 HAMBURG, Tyskland (DE)
Jan Meissner, Rellinger Str. 18, 20257 HAMBURG, Tyskland (DE)
Tobias Schreier, Karolinenstr. 14, 20357 HAMBURG, Tyskland (DE)

(55) **Designavbildninger:**

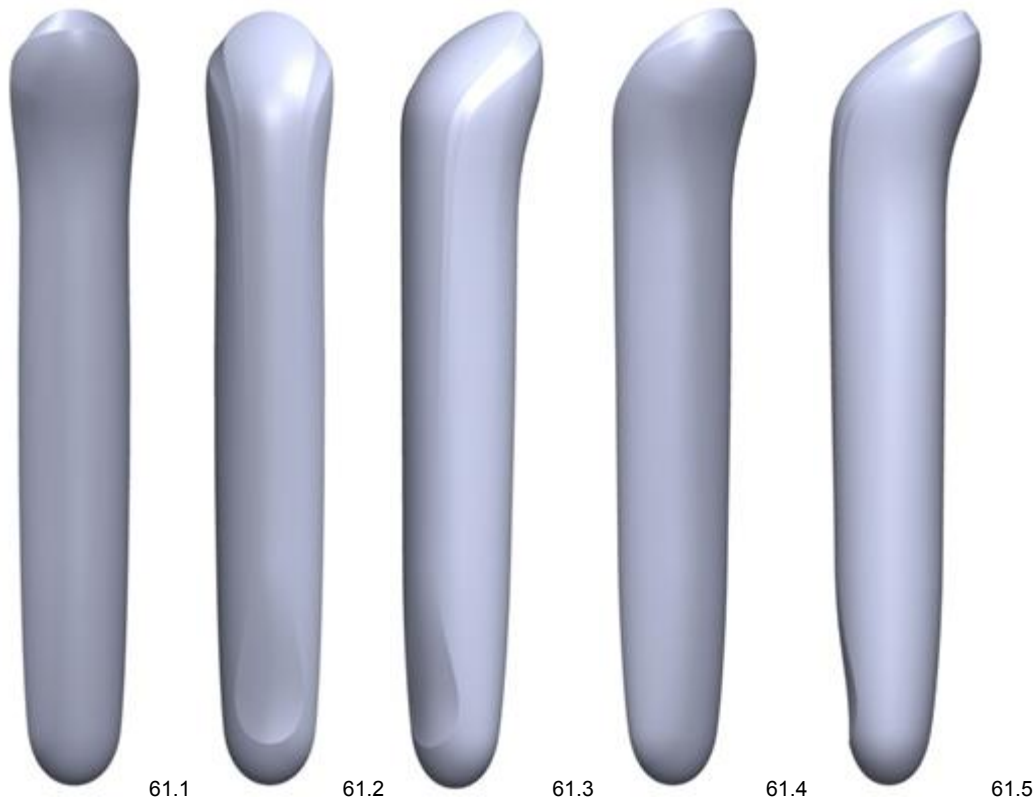

Design 62

- (54) **Produkt:** Adult toys
(51) **Klasse:** 28-03
(72) **Designer:** Paul Fally, Heinrich-Hertz-Strasse 37, 22085 HAMBURG, Tyskland (DE)
Johanna Königsberger, c/o Tiemann, Treskowstrasse 30, 20257 HAMBURG, Tyskland (DE)
Won-Gyung Lee, Boberger Strasse 17, 22111 HAMBURG, Tyskland (DE)
Jan Meissner, Rellinger Str. 18, 20257 HAMBURG, Tyskland (DE)
Tobias Schreier, Karolinenstr. 14, 20357 HAMBURG, Tyskland (DE)

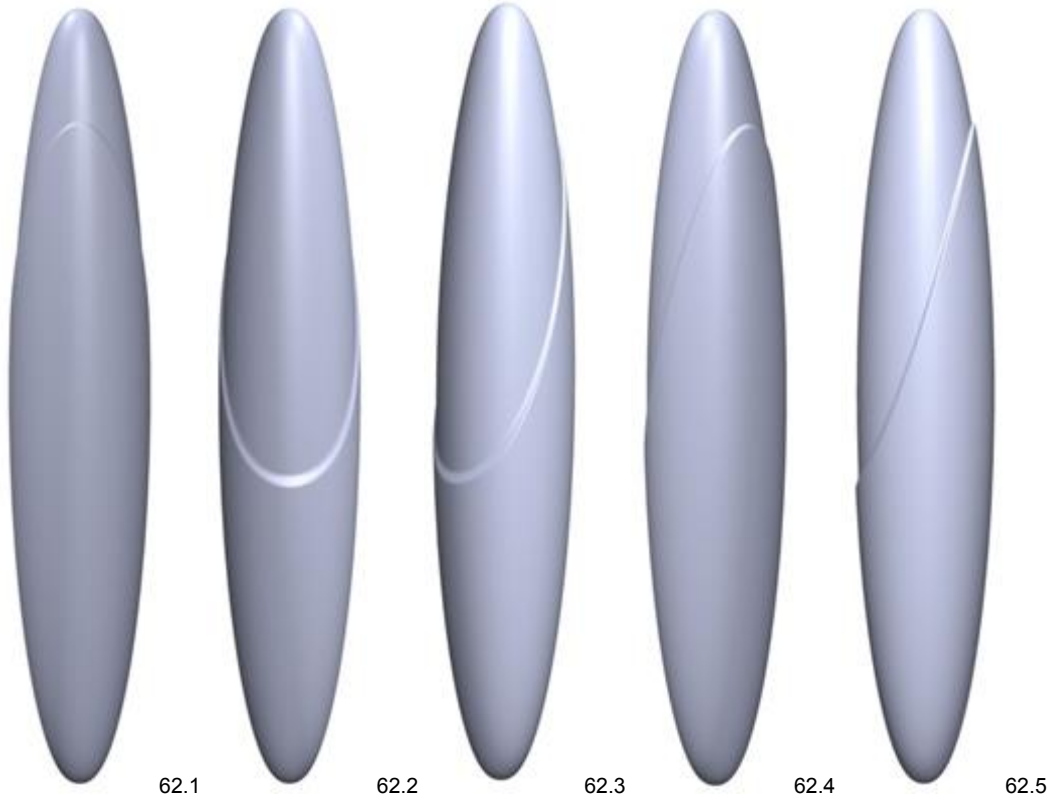
(55) Designavbildninger:

Design 63

- (54) **Produkt:** Adult toys
(51) **Klasse:** 28-03
(72) **Designer:** Paul Fally, Heinrich-Hertz-Strasse 37, 22085 HAMBURG, Tyskland (DE)
Johanna Königsberger, c/o Tiemann, Treskowstrasse 30, 20257 HAMBURG, Tyskland (DE)
Won-Gyung Lee, Boberger Strasse 17, 22111 HAMBURG, Tyskland (DE)
Jan Meissner, Rellinger Str. 18, 20257 HAMBURG, Tyskland (DE)
Tobias Schreier, Karolinenstr. 14, 20357 HAMBURG, Tyskland (DE)

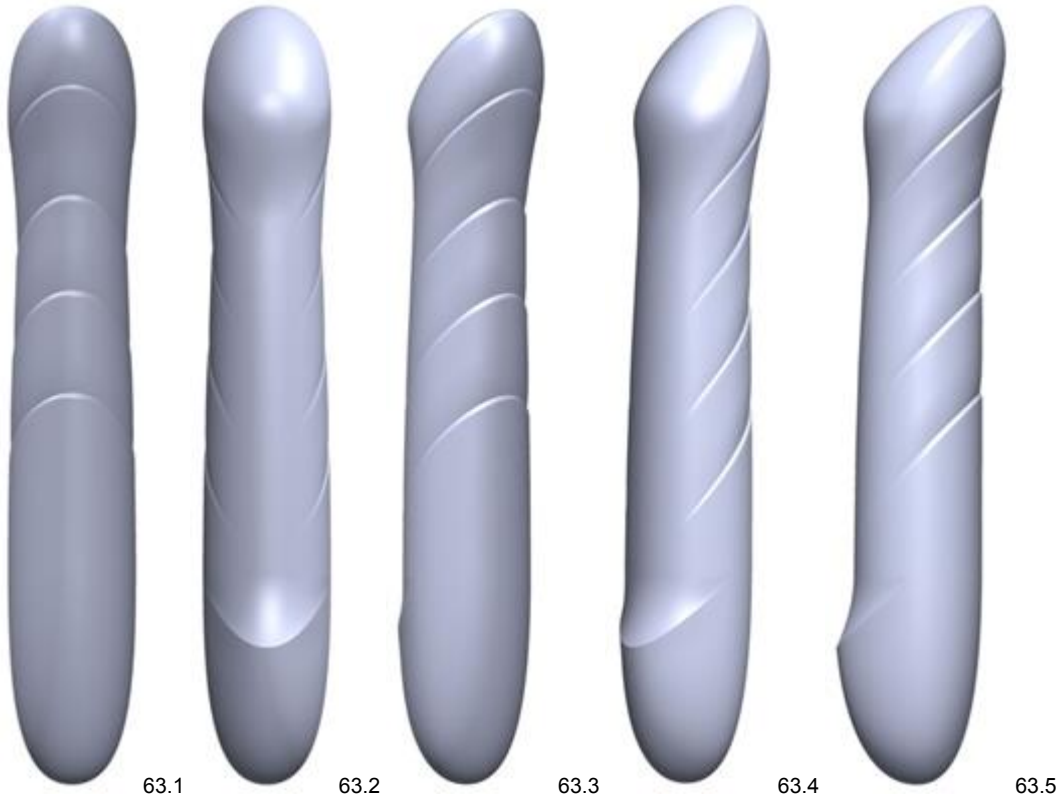
(55) Designavbildninger:

Design 64

- (54) **Produkt:** Adult toys
(51) **Klasse:** 28-03
(72) **Designer:** Paul Fally, Heinrich-Hertz-Strasse 37, 22085 HAMBURG, Tyskland (DE)
Johanna Königsberger, c/o Tiemann, Treskowstrasse 30, 20257 HAMBURG, Tyskland (DE)
Won-Gyung Lee, Boberger Strasse 17, 22111 HAMBURG, Tyskland (DE)
Jan Meissner, Rellinger Str. 18, 20257 HAMBURG, Tyskland (DE)
Tobias Schreier, Karolinenstr. 14, 20357 HAMBURG, Tyskland (DE)

(55) Designavbildninger:

64.1



64.2



64.3



64.4



64.5

Design 65

- (54) **Produkt:** Adult toys
(51) **Klasse:** 28-03
(72) **Designer:** Paul Fally, Heinrich-Hertz-Strasse 37, 22085 HAMBURG, Tyskland (DE)
Johanna Königsberger, c/o Tiemann, Treskowstrasse 30, 20257 HAMBURG, Tyskland (DE)
Won-Gyung Lee, Boberger Strasse 17, 22111 HAMBURG, Tyskland (DE)
Jan Meissner, Rellinger Str. 18, 20257 HAMBURG, Tyskland (DE)
Tobias Schreier, Karolinenstr. 14, 20357 HAMBURG, Tyskland (DE)

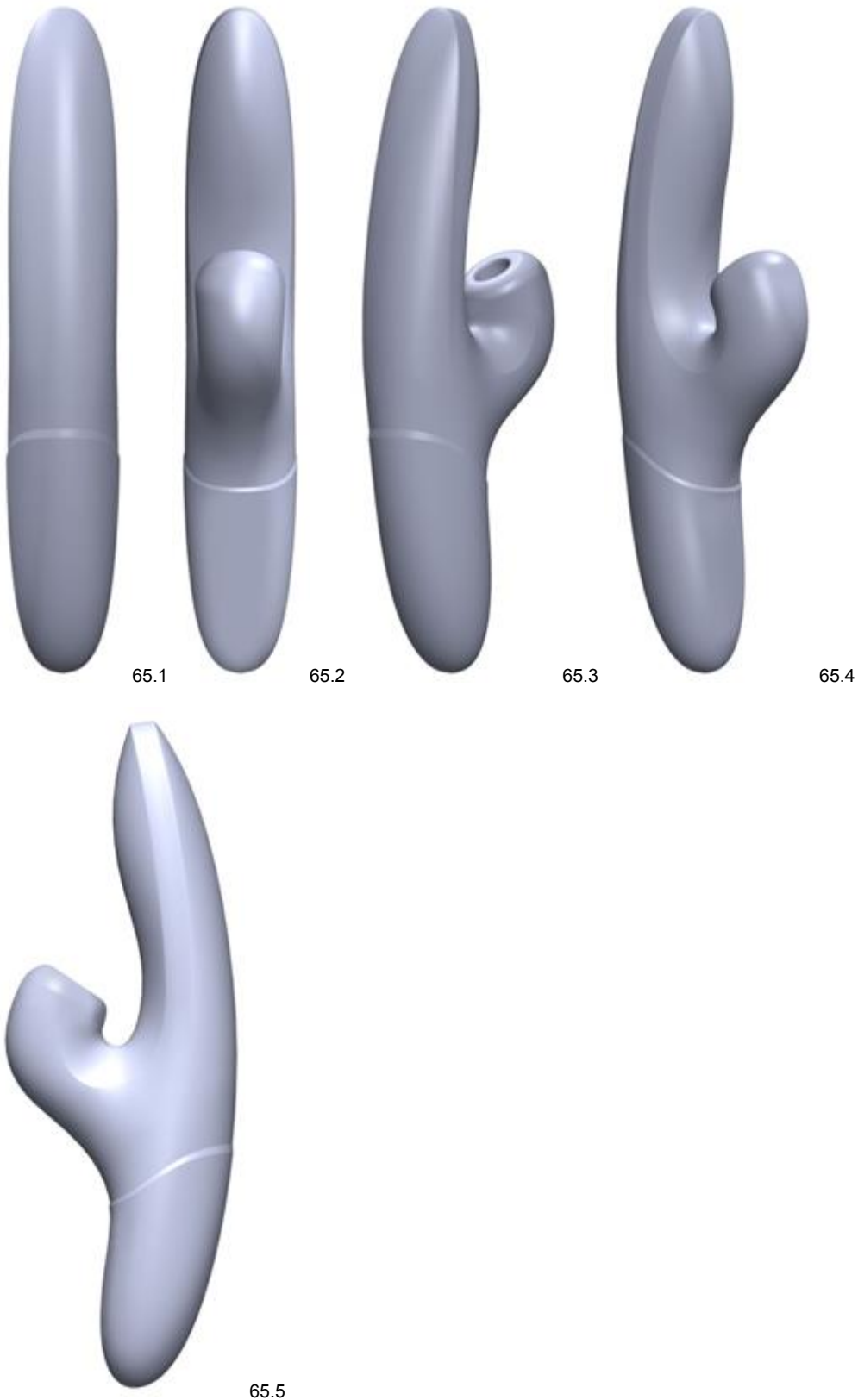
(55) Designavbildninger:

Design 66

- (54) **Produkt:** Adult toys
(51) **Klasse:** 28-03
(72) **Designer:** Paul Fally, Heinrich-Hertz-Strasse 37, 22085 HAMBURG, Tyskland (DE)
Johanna Königsberger, c/o Tiemann, Treskowstrasse 30, 20257 HAMBURG, Tyskland (DE)
Won-Gyung Lee, Boberger Strasse 17, 22111 HAMBURG, Tyskland (DE)
Jan Meissner, Rellinger Str. 18, 20257 HAMBURG, Tyskland (DE)
Tobias Schreier, Karolinenstr. 14, 20357 HAMBURG, Tyskland (DE)

(55) Designavbildninger:

66.1



66.2



66.3



66.4



66.5

Design 67

- (54) **Produkt:** Adult toys
(51) **Klasse:** 28-03
(72) **Designer:** Paul Fally, Heinrich-Hertz-Strasse 37, 22085 HAMBURG, Tyskland (DE)
Johanna Königsberger, c/o Tiemann, Treskowstrasse 30, 20257 HAMBURG, Tyskland (DE)
Won-Gyung Lee, Boberger Strasse 17, 22111 HAMBURG, Tyskland (DE)
Jan Meissner, Rellinger Str. 18, 20257 HAMBURG, Tyskland (DE)
Tobias Schreier, Karolinenstr. 14, 20357 HAMBURG, Tyskland (DE)

(55) **Designavbildninger:**

67.1



67.2



67.3



67.4



67.5

Design 68

- (54) **Produkt:** Adult toys
(51) **Klasse:** 28-03
(72) **Designer:** Paul Fally, Heinrich-Hertz-Strasse 37, 22085 HAMBURG, Tyskland (DE)
Johanna Königsberger, c/o Tiemann, Treskowstrasse 30, 20257 HAMBURG, Tyskland (DE)
Won-Gyung Lee, Boberger Strasse 17, 22111 HAMBURG, Tyskland (DE)
Jan Meissner, Rellinger Str. 18, 20257 HAMBURG, Tyskland (DE)
Tobias Schreier, Karolinenstr. 14, 20357 HAMBURG, Tyskland (DE)

(55) Designavbildninger:

68.1



68.2



68.3



68.4



68.5

Design 69

- (54) **Produkt:** Adult toys
(51) **Klasse:** 28-03
(72) **Designer:** Paul Fally, Heinrich-Hertz-Strasse 37, 22085 HAMBURG, Tyskland (DE)
Johanna Königsberger, c/o Tiemann, Treskowstrasse 30, 20257 HAMBURG, Tyskland (DE)
Won-Gyung Lee, Boberger Strasse 17, 22111 HAMBURG, Tyskland (DE)
Jan Meissner, Rellinger Str. 18, 20257 HAMBURG, Tyskland (DE)
Tobias Schreier, Karolinenstr. 14, 20357 HAMBURG, Tyskland (DE)

(55) Designavbildninger:

69.1



69.2



69.3



69.4



69.5

Design 70

- (54) **Produkt:** Adult toys
(51) **Klasse:** 28-03
(72) **Designer:** Paul Fally, Heinrich-Hertz-Strasse 37, 22085 HAMBURG, Tyskland (DE)
Johanna Königsberger, c/o Tiemann, Treskowstrasse 30, 20257 HAMBURG, Tyskland (DE)
Won-Gyung Lee, Boberger Strasse 17, 22111 HAMBURG, Tyskland (DE)
Jan Meissner, Rellinger Str. 18, 20257 HAMBURG, Tyskland (DE)
Tobias Schreier, Karolinenstr. 14, 20357 HAMBURG, Tyskland (DE)

(55) Designavbildninger:

70.1



70.2



70.3



70.4



70.5

Design 71

- (54) **Produkt:** Adult toys
(51) **Klasse:** 28-03
(72) **Designer:** Paul Fally, Heinrich-Hertz-Strasse 37, 22085 HAMBURG, Tyskland (DE)
Johanna Königsberger, c/o Tiemann, Treskowstrasse 30, 20257 HAMBURG, Tyskland (DE)
Won-Gyung Lee, Boberger Strasse 17, 22111 HAMBURG, Tyskland (DE)
Jan Meissner, Rellinger Str. 18, 20257 HAMBURG, Tyskland (DE)
Tobias Schreier, Karolinenstr. 14, 20357 HAMBURG, Tyskland (DE)

(55) Designavbildninger:

71.1



71.2



71.3



71.4



71.5

Design 72

- (54) **Produkt:** Adult toys
(51) **Klasse:** 28-03
(72) **Designer:** Paul Fally, Heinrich-Hertz-Strasse 37, 22085 HAMBURG, Tyskland (DE)
Johanna Königsberger, c/o Tiemann, Treskowstrasse 30, 20257 HAMBURG, Tyskland (DE)
Won-Gyung Lee, Boberger Strasse 17, 22111 HAMBURG, Tyskland (DE)
Jan Meissner, Rellinger Str. 18, 20257 HAMBURG, Tyskland (DE)
Tobias Schreier, Karolinenstr. 14, 20357 HAMBURG, Tyskland (DE)

(55) Designavbildninger:

72.1



72.2



72.3



72.4



72.5

Design 73

- (54) **Produkt:** Adult toys
(51) **Klasse:** 28-03
(72) **Designer:** Paul Fally, Heinrich-Hertz-Strasse 37, 22085 HAMBURG, Tyskland (DE)
Johanna Königsberger, c/o Tiemann, Treskowstrasse 30, 20257 HAMBURG, Tyskland (DE)
Won-Gyung Lee, Boberger Strasse 17, 22111 HAMBURG, Tyskland (DE)
Jan Meissner, Rellinger Str. 18, 20257 HAMBURG, Tyskland (DE)
Tobias Schreier, Karolinenstr. 14, 20357 HAMBURG, Tyskland (DE)

(55) Designavbildninger:

73.1



73.2



73.3



73.4



73.5

Design 74

- (54) **Produkt:** Adult toys
(51) **Klasse:** 28-03
(72) **Designer:** Paul Fally, Heinrich-Hertz-Strasse 37, 22085 HAMBURG, Tyskland (DE)
Johanna Königsberger, c/o Tiemann, Treskowstrasse 30, 20257 HAMBURG, Tyskland (DE)
Won-Gyung Lee, Boberger Strasse 17, 22111 HAMBURG, Tyskland (DE)
Jan Meissner, Rellinger Str. 18, 20257 HAMBURG, Tyskland (DE)
Tobias Schreier, Karolinenstr. 14, 20357 HAMBURG, Tyskland (DE)

(55) Designavbildninger:

74.1



74.2



74.3



74.4



74.5

Design 75

- (54) **Produkt:** Adult toys
(51) **Klasse:** 28-03
(72) **Designer:** Paul Fally, Heinrich-Hertz-Strasse 37, 22085 HAMBURG, Tyskland (DE)
Johanna Königsberger, c/o Tiemann, Treskowstrasse 30, 20257 HAMBURG, Tyskland (DE)
Won-Gyung Lee, Boberger Strasse 17, 22111 HAMBURG, Tyskland (DE)
Jan Meissner, Rellinger Str. 18, 20257 HAMBURG, Tyskland (DE)
Tobias Schreier, Karolinenstr. 14, 20357 HAMBURG, Tyskland (DE)

(55) Designavbildninger:

75.1



75.2



75.3



75.4

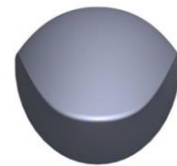

75.5



75.6

Design 76

- (54) **Produkt:** Adult toys
(51) **Klasse:** 28-03
(72) **Designer:** Paul Fally, Heinrich-Hertz-Strasse 37, 22085 HAMBURG, Tyskland (DE)
Johanna Königsberger, c/o Tiemann, Treskowstrasse 30, 20257 HAMBURG, Tyskland (DE)
Won-Gyung Lee, Boberger Strasse 17, 22111 HAMBURG, Tyskland (DE)
Jan Meissner, Rellinger Str. 18, 20257 HAMBURG, Tyskland (DE)
Tobias Schreier, Karolinenstr. 14, 20357 HAMBURG, Tyskland (DE)

(55) Designavbildninger:

76.1



76.2



76.3



76.4



76.5

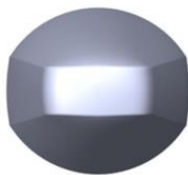

76.6

Design 77

- (54) **Produkt:** Adult toys
(51) **Klasse:** 28-03
(72) **Designer:** Paul Fally, Heinrich-Hertz-Strasse 37, 22085 HAMBURG, Tyskland (DE)
Johanna Königsberger, c/o Tiemann, Treskowstrasse 30, 20257 HAMBURG, Tyskland (DE)
Won-Gyung Lee, Boberger Strasse 17, 22111 HAMBURG, Tyskland (DE)
Jan Meissner, Rellinger Str. 18, 20257 HAMBURG, Tyskland (DE)
Tobias Schreier, Karolinenstr. 14, 20357 HAMBURG, Tyskland (DE)

(55) Designavbildninger:

77.1



77.2



77.3



77.4



77.5



77.6

Design 78(54) **Produkt:** Adult toys(51) **Klasse:** 28-03(72) **Designer:**

Paul Fally, Heinrich-Hertz-Strasse 37, 22085 HAMBURG, Tyskland (DE)

Johanna Königsberger, c/o Tiemann, Treskowstrasse 30, 20257 HAMBURG, Tyskland (DE)

Won-Gyung Lee, Boberger Strasse 17, 22111 HAMBURG, Tyskland (DE)

Jan Meissner, Rellinger Str. 18, 20257 HAMBURG, Tyskland (DE)

Tobias Schreier, Karolinenstr. 14, 20357 HAMBURG, Tyskland (DE)

(55) **Designavbildninger:**

78.1

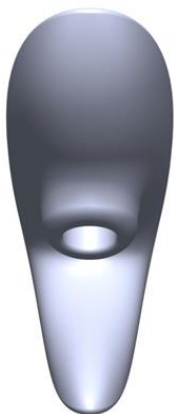

78.2



78.3



78.4



78.5



78.6

Design 79(54) **Produkt:** Adult toys(51) **Klasse:** 28-03(72) **Designer:**

Paul Fally, Heinrich-Hertz-Strasse 37, 22085 HAMBURG, Tyskland (DE)

Johanna Königsberger, c/o Tiemann, Treskowstrasse 30, 20257 HAMBURG, Tyskland (DE)

Won-Gyung Lee, Boberger Strasse 17, 22111 HAMBURG, Tyskland (DE)

Jan Meissner, Rellinger Str. 18, 20257 HAMBURG, Tyskland (DE)

Tobias Schreier, Karolinenstr. 14, 20357 HAMBURG, Tyskland (DE)

(55) **Designavbildninger:**

79.1



79.2



79.3



79.4



79.5

Design 80(54) **Produkt:**

Adult toys

(51) **Klasse:**

28-03

(72) **Designer:**

Paul Fally, Heinrich-Hertz-Strasse 37, 22085 HAMBURG, Tyskland (DE)

Johanna Königsberger, c/o Tiemann, Treskowstrasse 30, 20257 HAMBURG, Tyskland (DE)

Won-Gyung Lee, Boberger Strasse 17, 22111 HAMBURG, Tyskland (DE)

Jan Meissner, Rellinger Str. 18, 20257 HAMBURG, Tyskland (DE)

Tobias Schreier, Karolinenstr. 14, 20357 HAMBURG, Tyskland (DE)

(55) **Designavbildninger:**

80.1



80.2



80.3



80.4



80.5

Design 81

- (54) **Produkt:** Adult toys
(51) **Klasse:** 28-03
(72) **Designer:** Paul Fally, Heinrich-Hertz-Strasse 37, 22085 HAMBURG, Tyskland (DE)
Johanna Königsberger, c/o Tiemann, Treskowstrasse 30, 20257 HAMBURG, Tyskland (DE)
Won-Gyung Lee, Boberger Strasse 17, 22111 HAMBURG, Tyskland (DE)
Jan Meissner, Rellinger Str. 18, 20257 HAMBURG, Tyskland (DE)
Tobias Schreier, Karolinenstr. 14, 20357 HAMBURG, Tyskland (DE)

(55) Designavbildninger:

81.1



81.2



81.3



81.4



81.5

Design 82

(54) **Produkt:** Adult toys
(51) **Klasse:** 28-03
(72) **Designer:** Paul Fally, Heinrich-Hertz-Strasse 37, 22085 HAMBURG, Tyskland (DE)
Johanna Königsberger, c/o Tiemann, Treskowstrasse 30, 20257 HAMBURG, Tyskland (DE)
Won-Gyung Lee, Boberger Strasse 17, 22111 HAMBURG, Tyskland (DE)
Jan Meissner, Rellinger Str. 18, 20257 HAMBURG, Tyskland (DE)
Tobias Schreier, Karolinenstr. 14, 20357 HAMBURG, Tyskland (DE)

(55) Designavbildninger:

82.1



82.2



82.3



82.4



82.5

Design 83

(54) **Produkt:**
(51) **Klasse:**
(72) **Designer:**

Adult toys
28-03
Paul Fally, Heinrich-Hertz-Strasse 37, 22085 HAMBURG, Tyskland (DE)
Johanna Königsberger, c/o Tiemann, Treskowstrasse 30, 20257 HAMBURG, Tyskland (DE)
Won-Gyung Lee, Boberger Strasse 17, 22111 HAMBURG, Tyskland (DE)
Jan Meissner, Rellinger Str. 18, 20257 HAMBURG, Tyskland (DE)
Tobias Schreier, Karolinenstr. 14, 20357 HAMBURG, Tyskland (DE)

(55) **Designavbildninger:**



83.1



83.2



83.3



83.4



83.5

Design 84

(54) **Produkt:** Adult toys
(51) **Klasse:** 28-03
(72) **Designer:** Paul Fally, Heinrich-Hertz-Strasse 37, 22085 HAMBURG, Tyskland (DE)
Johanna Königsberger, c/o Tiemann, Treskowstrasse 30, 20257 HAMBURG, Tyskland (DE)
Won-Gyung Lee, Boberger Strasse 17, 22111 HAMBURG, Tyskland (DE)
Jan Meissner, Rellinger Str. 18, 20257 HAMBURG, Tyskland (DE)
Tobias Schreier, Karolinenstr. 14, 20357 HAMBURG, Tyskland (DE)

(55) Designavbildninger:

84.1



84.2



84.3



84.4

Design 85

(54) **Produkt:** Adult toys
(51) **Klasse:** 28-03
(72) **Designer:** Paul Fally, Heinrich-Hertz-Strasse 37, 22085 HAMBURG, Tyskland (DE)
Johanna Königsberger, c/o Tiemann, Treskowstrasse 30, 20257 HAMBURG, Tyskland (DE)
Won-Gyung Lee, Boberger Strasse 17, 22111 HAMBURG, Tyskland (DE)
Jan Meissner, Rellinger Str. 18, 20257 HAMBURG, Tyskland (DE)
Tobias Schreier, Karolinenstr. 14, 20357 HAMBURG, Tyskland (DE)

(55) Designavbildninger:

85.1



85.2



85.3



85.4



85.5

Design 86

(54) **Produkt:** Adult toys

(51) **Klasse:** 28-03

(72) **Designer:**

Paul Fally, Heinrich-Hertz-Strasse 37, 22085 HAMBURG, Tyskland (DE)

Johanna Königsberger, c/o Tiemann, Treskowstrasse 30, 20257 HAMBURG, Tyskland (DE)

Won-Gyung Lee, Boberger Strasse 17, 22111 HAMBURG, Tyskland (DE)

Jan Meissner, Rellinger Str. 18, 20257 HAMBURG, Tyskland (DE)

Tobias Schreier, Karolinenstr. 14, 20357 HAMBURG, Tyskland (DE)

(55) **Designavbildninger:**



86.1



86.2



86.3



86.4



86.5

Design 87

(54) **Produkt:** Adult toys
(51) **Klasse:** 28-03
(72) **Designer:** Paul Fally, Heinrich-Hertz-Strasse 37, 22085 HAMBURG, Tyskland (DE)
Johanna Königsberger, c/o Tiemann, Treskowstrasse 30, 20257 HAMBURG, Tyskland (DE)
Won-Gyung Lee, Boberger Strasse 17, 22111 HAMBURG, Tyskland (DE)
Jan Meissner, Rellinger Str. 18, 20257 HAMBURG, Tyskland (DE)
Tobias Schreier, Karolinenstr. 14, 20357 HAMBURG, Tyskland (DE)

(55) Designavbildninger:

87.1



87.2



87.3



87.4



87.5

Design 88

(54) **Produkt:** Adult toys
(51) **Klasse:** 28-03
(72) **Designer:** Paul Fally, Heinrich-Hertz-Strasse 37, 22085 HAMBURG, Tyskland (DE)
Johanna Königsberger, c/o Tiemann, Treskowstrasse 30, 20257 HAMBURG, Tyskland (DE)
Won-Gyung Lee, Boberger Strasse 17, 22111 HAMBURG, Tyskland (DE)
Jan Meissner, Rellinger Str. 18, 20257 HAMBURG, Tyskland (DE)
Tobias Schreier, Karolinenstr. 14, 20357 HAMBURG, Tyskland (DE)

(55) Designavbildninger:

88.1



88.2



88.3



88.4



88.5

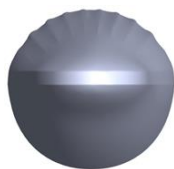

88.6

Design 89

- (54) **Produkt:** Adult toys
(51) **Klasse:** 28-03
(72) **Designer:** Paul Fally, Heinrich-Hertz-Strasse 37, 22085 HAMBURG, Tyskland (DE)
Johanna Königsberger, c/o Tiemann, Treskowstrasse 30, 20257 HAMBURG, Tyskland (DE)
Won-Gyung Lee, Boberger Strasse 17, 22111 HAMBURG, Tyskland (DE)
Jan Meissner, Rellinger Str. 18, 20257 HAMBURG, Tyskland (DE)
Tobias Schreier, Karolinenstr. 14, 20357 HAMBURG, Tyskland (DE)

(55) Designavbildninger:

89.1



89.2



89.3



89.4



89.5

Design 90

- (54) **Produkt:** Adult toys
(51) **Klasse:** 28-03
(72) **Designer:** Paul Fally, Heinrich-Hertz-Strasse 37, 22085 HAMBURG, Tyskland (DE)
Johanna Königsberger, c/o Tiemann, Treskowstrasse 30, 20257 HAMBURG, Tyskland (DE)
Won-Gyung Lee, Boberger Strasse 17, 22111 HAMBURG, Tyskland (DE)
Jan Meissner, Rellinger Str. 18, 20257 HAMBURG, Tyskland (DE)
Tobias Schreier, Karolinenstr. 14, 20357 HAMBURG, Tyskland (DE)

(55) Designavbildninger:

90.1



90.2



90.3



90.4



90.5

Design 91

- (54) **Produkt:** Adult toys
(51) **Klasse:** 28-03
(72) **Designer:** Paul Fally, Heinrich-Hertz-Strasse 37, 22085 HAMBURG, Tyskland (DE)
Johanna Königsberger, c/o Tiemann, Treskowstrasse 30, 20257 HAMBURG, Tyskland (DE)
Won-Gyung Lee, Boberger Strasse 17, 22111 HAMBURG, Tyskland (DE)
Jan Meissner, Rellinger Str. 18, 20257 HAMBURG, Tyskland (DE)
Tobias Schreier, Karolinenstr. 14, 20357 HAMBURG, Tyskland (DE)

(55) Designavbildninger:

91.1



91.2



91.3

Design 92

- (54) **Produkt:** Adult toys
(51) **Klasse:** 28-03
(72) **Designer:** Paul Fally, Heinrich-Hertz-Strasse 37, 22085 HAMBURG, Tyskland (DE)
Johanna Königsberger, c/o Tiemann, Treskowstrasse 30, 20257 HAMBURG, Tyskland (DE)
Won-Gyung Lee, Boberger Strasse 17, 22111 HAMBURG, Tyskland (DE)
Jan Meissner, Rellinger Str. 18, 20257 HAMBURG, Tyskland (DE)
Tobias Schreier, Karolinenstr. 14, 20357 HAMBURG, Tyskland (DE)

(55) Designavbildninger:

92.1



92.2



92.3

Design 93

- (54) **Produkt:** Adult toys
(51) **Klasse:** 28-03
(72) **Designer:** Paul Fally, Heinrich-Hertz-Strasse 37, 22085 HAMBURG, Tyskland (DE)
Johanna Königsberger, c/o Tiemann, Treskowstrasse 30, 20257 HAMBURG, Tyskland (DE)
Won-Gyung Lee, Boberger Strasse 17, 22111 HAMBURG, Tyskland (DE)
Jan Meissner, Rellinger Str. 18, 20257 HAMBURG, Tyskland (DE)
Tobias Schreier, Karolinenstr. 14, 20357 HAMBURG, Tyskland (DE)

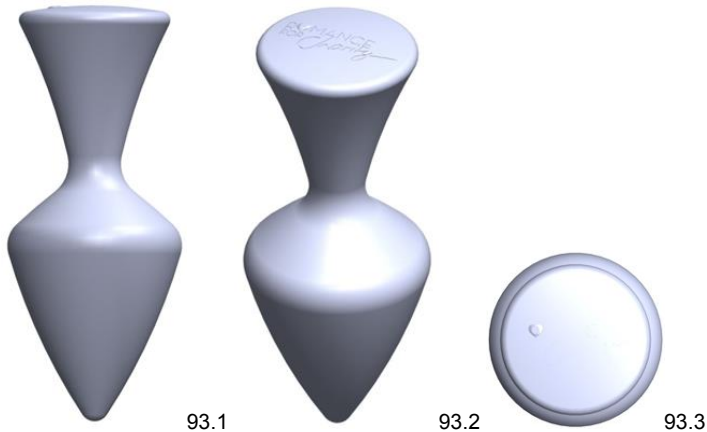
(55) Designavbildninger:**Design 94**

- (54) **Produkt:** Adult toys
(51) **Klasse:** 28-03
(72) **Designer:** Paul Fally, Heinrich-Hertz-Strasse 37, 22085 HAMBURG, Tyskland (DE)
Johanna Königsberger, c/o Tiemann, Treskowstrasse 30, 20257 HAMBURG, Tyskland (DE)
Won-Gyung Lee, Boberger Strasse 17, 22111 HAMBURG, Tyskland (DE)
Jan Meissner, Rellinger Str. 18, 20257 HAMBURG, Tyskland (DE)
Tobias Schreier, Karolinenstr. 14, 20357 HAMBURG, Tyskland (DE)

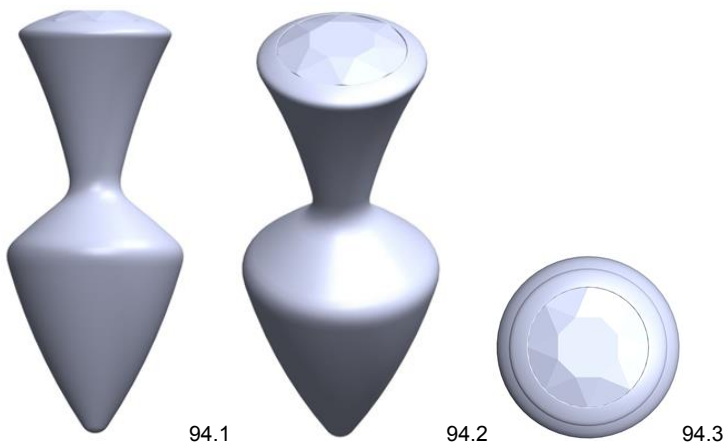
(55) Designavbildninger:

Design 95

- (54) **Produkt:** Adult toys
(51) **Klasse:** 28-03
(72) **Designer:** Paul Fally, Heinrich-Hertz-Strasse 37, 22085 HAMBURG, Tyskland (DE)
Johanna Königsberger, c/o Tiemann, Treskowstrasse 30, 20257 HAMBURG, Tyskland (DE)
Won-Gyung Lee, Boberger Strasse 17, 22111 HAMBURG, Tyskland (DE)
Jan Meissner, Rellinger Str. 18, 20257 HAMBURG, Tyskland (DE)
Tobias Schreier, Karolinenstr. 14, 20357 HAMBURG, Tyskland (DE)

(55) Designavbildninger:

95.1



95.2



95.3



95.4



95.5

Design 96

- (54) **Produkt:** Adult toys
(51) **Klasse:** 28-03
(72) **Designer:** Paul Fally, Heinrich-Hertz-Strasse 37, 22085 HAMBURG, Tyskland (DE)
Johanna Königsberger, c/o Tiemann, Treskowstrasse 30, 20257 HAMBURG, Tyskland (DE)
Won-Gyung Lee, Boberger Strasse 17, 22111 HAMBURG, Tyskland (DE)
Jan Meissner, Rellinger Str. 18, 20257 HAMBURG, Tyskland (DE)
Tobias Schreier, Karolinenstr. 14, 20357 HAMBURG, Tyskland (DE)

(55) Designavbildninger:

96.1



96.2



96.3



96.4



96.5

Design 97

- (54) **Produkt:** Adult toys
(51) **Klasse:** 28-03
(72) **Designer:** Paul Fally, Heinrich-Hertz-Strasse 37, 22085 HAMBURG, Tyskland (DE)
Johanna Königsberger, c/o Tiemann, Treskowstrasse 30, 20257 HAMBURG, Tyskland (DE)
Won-Gyung Lee, Boberger Strasse 17, 22111 HAMBURG, Tyskland (DE)
Jan Meissner, Rellinger Str. 18, 20257 HAMBURG, Tyskland (DE)
Tobias Schreier, Karolinenstr. 14, 20357 HAMBURG, Tyskland (DE)

(55) Designavbildninger:

97.1



97.2



97.3



97.4



97.5

Design 98

- (54) **Produkt:** Adult toys
(51) **Klasse:** 28-03
(72) **Designer:** Paul Fally, Heinrich-Hertz-Strasse 37, 22085 HAMBURG, Tyskland (DE)
Johanna Königsberger, c/o Tiemann, Treskowstrasse 30, 20257 HAMBURG, Tyskland (DE)
Won-Gyung Lee, Boberger Strasse 17, 22111 HAMBURG, Tyskland (DE)
Jan Meissner, Rellinger Str. 18, 20257 HAMBURG, Tyskland (DE)
Tobias Schreier, Karolinenstr. 14, 20357 HAMBURG, Tyskland (DE)

(55) Designavbildninger:

98.1



98.2



98.3



98.4

(11)	Reg.nr.:	DM/098425
(21)	Søkn.nr.:	20171207
(22)	Inngitt i WIPO:	2017.11.08
(15)	Registrert i WIPO:	2017.11.08
(24)	Løpedag:	2017.11.08
(43)	Allm. tilgj.:	2018.05.11
(15)	Besluttet gjeldende NO:	2018.06.18
(45)	Kunngjort NO:	2018.07.16
(18)	Reg. gjelder til:	2022.11.08
(73)	Innehaver:	Volkswagen Aktiengesellschaft, Berliner Ring 2, DE-38440 WOLFSBURG, Tyskland
(50)	Anmerkninger:	Registreringen gjelder samregistrering.

Design 1

(54)	Produkt:	Wheel rims
(51)	Klasse:	12-16
(72)	Designer:	Ranbir Kalha, c/o Volkswagen AG, Brieffach 1843, 38436 WOLFSBURG, Tyskland (DE)
(30)	Prioritet:	2017.07.25, DE, 402017100852.1, 1, 2, 3, 4, 5, 6, 7, 8, 9
(55)	Designavbildninger:	



1.1



1.2

Design 2

(54)	Produkt:	Wheel rims
(51)	Klasse:	12-16
(72)	Designer:	Ranbir Kalha, c/o Volkswagen AG, Brieffach 1843, 38436 WOLFSBURG, Tyskland (DE)
(30)	Prioritet:	2017.07.25, DE, 402017100852.1, 1, 2, 3, 4, 5, 6, 7, 8, 9
(55)	Designavbildninger:	



2.1



2.2

Design 3

(54) **Produkt:** Wheel rims
(51) **Klasse:** 12-16
(72) **Designer:** Raina Wada, c/o Volkswagen AG, Brieffach 1843, 38436 WOLFSBURG, Tyskland (DE)
(30) **Prioritet:** 2017.07.25, DE, 402017100852.1, 1, 2, 3, 4, 5, 6, 7, 8, 9
(55) **Designavbildninger:**



3.1



3.2

Design 4

(54) **Produkt:** Wheel rims
(51) **Klasse:** 12-16
(72) **Designer:** Raina Wada, c/o Volkswagen AG, Brieffach 1843, 38436 WOLFSBURG, Tyskland (DE)
(30) **Prioritet:** 2017.07.25, DE, 402017100852.1, 1, 2, 3, 4, 5, 6, 7, 8, 9
(55) **Designavbildninger:**



4.1



4.2

Design 5

(54) **Produkt:** Wheel rims
(51) **Klasse:** 12-16
(72) **Designer:** Ranbir Kalha, c/o Volkswagen AG, Brieffach 1843, 38436 WOLFSBURG, Tyskland (DE)
(30) **Prioritet:** 2017.07.25, DE, 402017100852.1, 1, 2, 3, 4, 5, 6, 7, 8, 9
(55) **Designavbildninger:**



5.1



5.2

Design 6

- (54) **Produkt:** Wheel rims
(51) **Klasse:** 12-16
(72) **Designer:** Matthias Valencia, c/o Volkswagen AG, Postfach 1843, 38436 WOLFSBURG, Tyskland (DE)
(30) **Prioritet:** 2017.07.25, DE, 402017100852.1, 1, 2, 3, 4, 5, 6, 7, 8, 9
(55) **Designavbildninger:**



6.1



6.2

Design 7

- (54) **Produkt:** Wheel rims
(51) **Klasse:** 12-16
(72) **Designer:** Matthias Valencia, c/o Volkswagen AG, Postfach 1843, 38436 WOLFSBURG, Tyskland (DE)
(30) **Prioritet:** 2017.07.25, DE, 402017100852.1, 1, 2, 3, 4, 5, 6, 7, 8, 9
(55) **Designavbildninger:**



7.1



7.2

Design 8

- (54) **Produkt:** Wheel rims
(51) **Klasse:** 12-16
(72) **Designer:** Miguel Angel García L., c/o Volkswagen AG, Brieffach 1770, 38436 WOLFSBURG, Tyskland (DE)
(30) **Prioritet:** 2017.07.25, DE, 402017100852.1, 1, 2, 3, 4, 5, 6, 7, 8, 9
(55) **Designavbildninger:**



8.1



8.2

Design 9

(54) **Produkt:** Wheel rims
(51) **Klasse:** 12-16
(72) **Designer:** Matthias Valencia, c/o Volkswagen AG, Postfach 1843, 38436 WOLFSBURG, Tyskland (DE)
(30) **Prioritet:** 2017.07.25, DE, 402017100852.1, 1, 2, 3, 4, 5, 6, 7, 8, 9
(55) **Designavbildninger:**



9.1



9.2

(11)	Reg.nr.:	DM/098532
(21)	Søkn.nr.:	20171209
(22)	Inngitt i WIPO:	2017.11.14
(15)	Registrert i WIPO:	2017.11.14
(24)	Løpedag:	2017.11.14
(43)	Allm. tilgj.:	2018.05.18
(15)	Besluttet gjeldende NO:	2018.06.25
(45)	Kunngjort NO:	2018.07.16
(18)	Reg. gjelder til:	2022.11.14
(73)	Innehaver:	RADO UHREN AG (RADO WATCH CO.LTD.) (MONTRES RADO SA), Bielstrasse 45, CH-2543 LENGNAU, Sveits

Design 1

(54)	Produkt:	Watch
(51)	Klasse:	10-02
(72)	Designer:	Mélanie Armenti, Mittelstrasse 29, 2560 NIDAU, Sveits (CH)
(55)	Designavbildninger:	

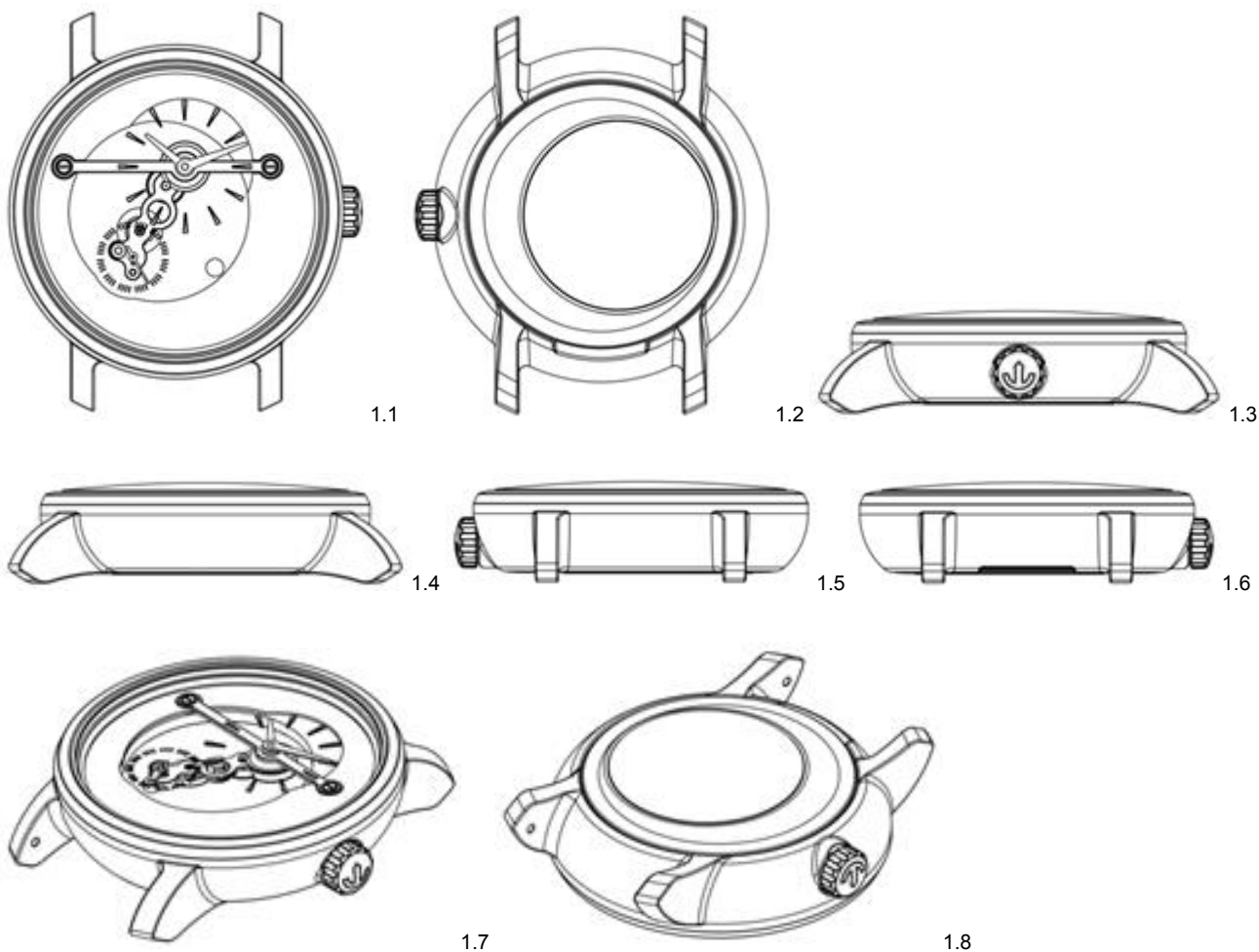

(11)	Reg.nr.:	DM/098534
(21)	Søkn.nr.:	20171210
(22)	Inngitt i WIPO:	2017.11.14
(15)	Registrert i WIPO:	2017.11.14
(24)	Løpedag:	2017.11.14
(43)	Allm. tilgj.:	2018.05.18
(15)	Besluttet gjeldende NO:	2018.06.25
(45)	Kunngjort NO:	2018.07.16
(18)	Reg. gjelder til:	2022.11.14
(73)	Innehaver:	RADO UHREN AG (RADO WATCH CO.LTD.) (MONTRES RADO SA), Bielstrasse 45, CH-2543 LENGNAU, Sveits

Design 1

(54)	Produkt:	Watch
(51)	Klasse:	10-02
(72)	Designer:	Stéphanie Lacroix-Gachet, Rue de St-Jean 92, 1201 GENÈVE, Sveits (CH)
(55)	Designavbildninger:	

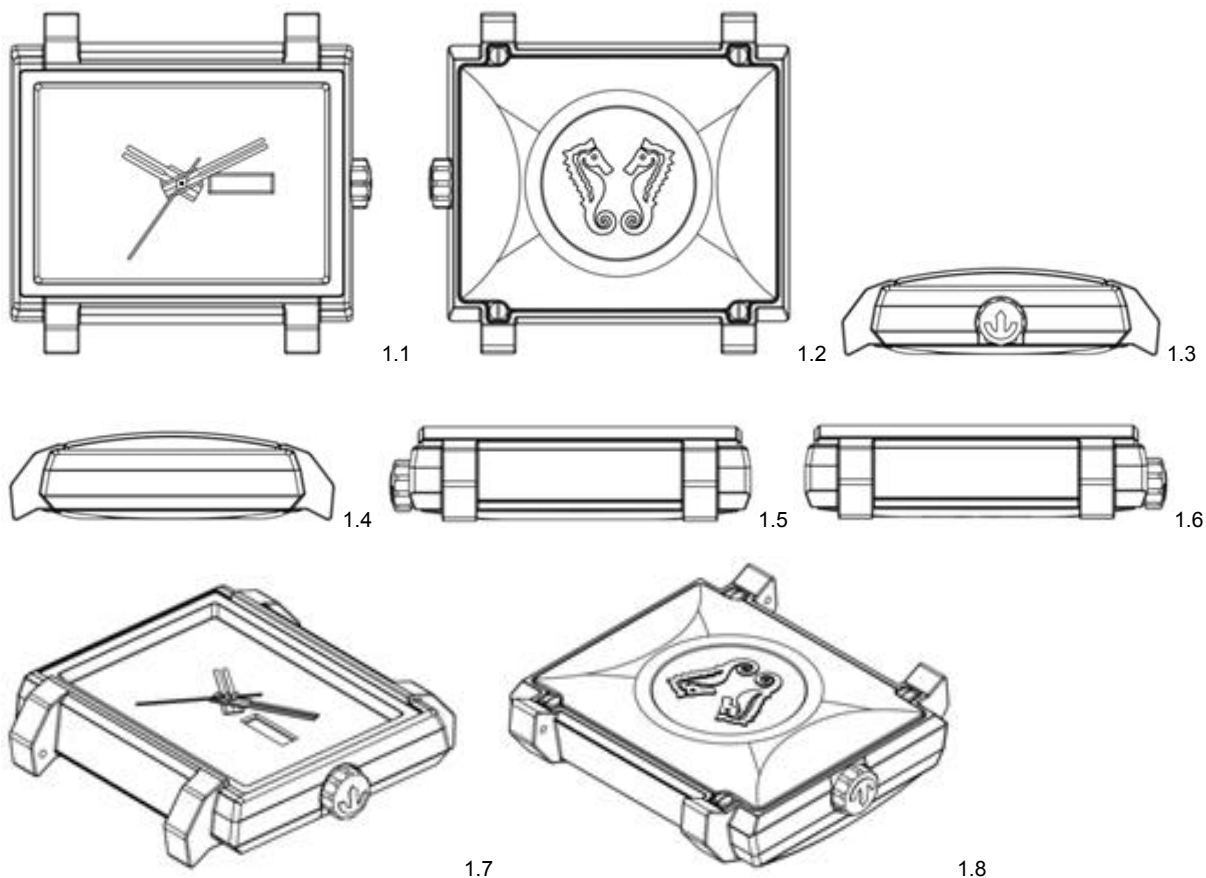

(11)	Reg.nr.:	DM/098535
(21)	Søkn.nr.:	20171211
(22)	Inngitt i WIPO:	2017.11.14
(15)	Registrert i WIPO:	2017.11.14
(24)	Løpedag:	2017.11.14
(43)	Allm. tilgj.:	2018.05.18
(15)	Besluttet gjeldende NO:	2018.06.25
(45)	Kunngjort NO:	2018.07.16
(18)	Reg. gjelder til:	2022.11.14
(73)	Innehaver:	RADO UHREN AG (RADO WATCH CO.LTD.) (MONTRES RADO SA), Bielstrasse 45, CH-2543 LENGNAU, Sveits

Design 1

(54)	Produkt:	Wristwatch
(51)	Klasse:	10-02
(72)	Designer:	Fabrice Duport, Avenue de la Gare, 4, 2000 NEUCHÂTEL, Sveits (CH)
(55)	Designavbildninger:	



1.1

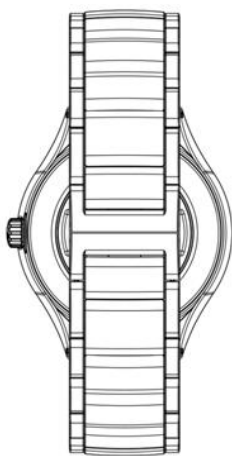

1.2



1.3



1.4

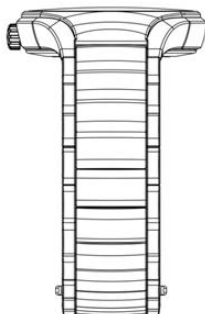

1.5

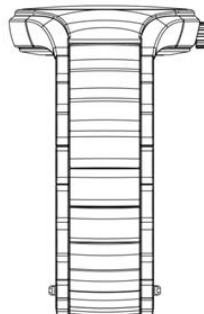

1.6



1.7



1.8

(11)	Reg.nr.:	DM/098546
(21)	Søkn.nr.:	20171206
(22)	Inngitt i WIPO:	2017.11.06
(15)	Registrert i WIPO:	2017.11.06
(24)	Løpedag:	2017.11.06
(43)	Allm. tilgj.:	2018.05.11
(15)	Besluttet gjeldende NO:	2018.06.18
(45)	Kunngjort NO:	2018.07.16
(18)	Reg. gjelder til:	2022.11.06
(73)	Innehaver:	SWATCH AG (SWATCH SA) (SWATCH LTD.), Jakob-Stämpfli-Strasse 94, CH-2502 BIEL/BIENNE, Sveits
(50)	Anmerkninger:	Registreringen gjelder samregistrering.

Design 1

(54)	Produkt:	Watch
(51)	Klasse:	10-02
(72)	Designer:	Shay TAKO, Sieberstrasse 14, 8055 ZURICH, Sveits (CH)
(50)	Anmerkning:	Designet er i farger.
(55)	Designavbildninger:	



1.1



1.2



1.3

Design 2

(54)	Produkt:	Watch support
(51)	Klasse:	10-02
(72)	Designer:	Shay TAKO, Sieberstrasse 14, 8055 ZURICH, Sveits (CH)
(50)	Anmerkning:	Designet er i farger.
(55)	Designavbildninger:	



2.1



2.2



2.3



2.4

(11)	Reg.nr.:	DM/098567
(21)	Søkn.nr.:	20171203
(22)	Inngitt i WIPO:	2017.11.03
(15)	Registrert i WIPO:	2017.11.03
(24)	Løpedag:	2017.11.03
(43)	Allm. tilgj.:	2018.05.04
(15)	Besluttet gjeldende NO:	2018.06.20
(45)	Kunngjort NO:	2018.07.16
(18)	Reg. gjelder til:	2022.11.03
(73)	Innehaver:	Pi-Design AG, Kantonsstrasse 100, CH-6234 TRIENGEN, Sveits

Design 1

(54)	Produkt:	Hold handle for coffee maker
(51)	Klasse:	07-02
(72)	Designer:	Jorgen Bodum, Käppelistrasse 15, 6045 MEGGEN, Sveits (CH)
(50)	Anmerkning:	Designet er i farger.
(55)	Designavbildninger:	





1.6



1.7

(11)	Reg.nr.:	DM/098590
(21)	Søkn.nr.:	20171202
(22)	Inngitt i WIPO:	2017.11.02
(15)	Registrert i WIPO:	2017.11.02
(24)	Løpedag:	2017.11.02
(43)	Allm. tilgj.:	2018.05.04
(15)	Besluttet gjeldende NO:	2018.06.20
(45)	Kunngjort NO:	2018.07.16
(18)	Reg. gjelder til:	2022.11.02
(73)	Innehaver:	TOMRA SYSTEMS ASA, Drengsrudhagen 2, 1372 ASKER, Norge
(50)	Anmerkninger:	Registreringen gjelder samregistrering.

Design 1

(54)	Produkt:	Panels for a reverse vending machine
(51)	Klasse:	20-01
(72)	Designer:	Silje Sandahl Näs, c/o Tomra Systems ASA, Drengsrudhagen 2, 1372 ASKER
(55)	Designavbildninger:	

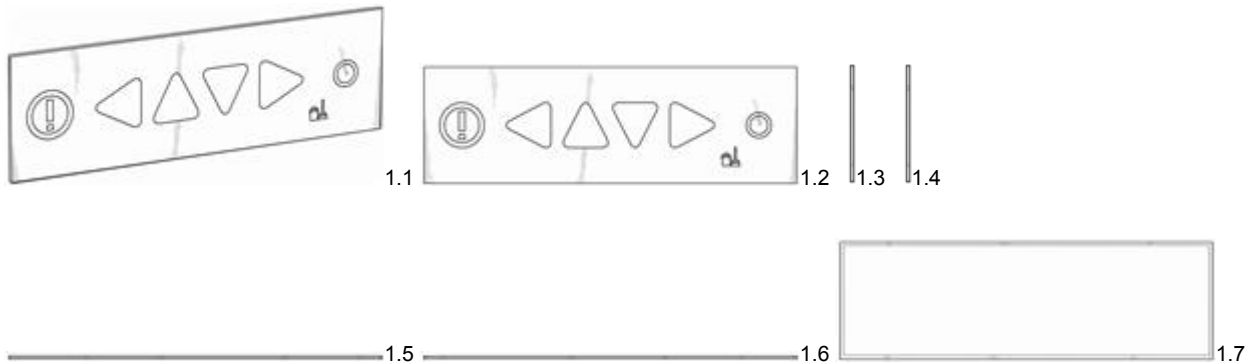
**Design 2**

(54)	Produkt:	Panels for a reverse vending machine
(51)	Klasse:	20-01
(72)	Designer:	Silje Sandahl Näs, c/o Tomra Systems ASA, Drengsrudhagen 2, 1372 ASKER
(55)	Designavbildninger:	

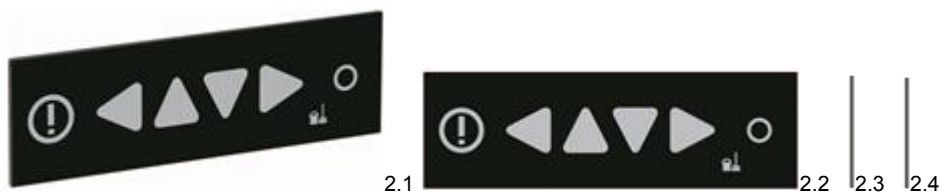



Design 3

- (54) **Produkt:** Panels for a reverse vending machine
- (51) **Klasse:** 20-01
- (72) **Designer:** Silje Sandahl Näs, c/o Tomra Systems ASA, Drengsrudhagen 2, 1372 ASKER
- (50) **Anmerkning:** Designet er farger.
- (55) **Designavbildninger:**

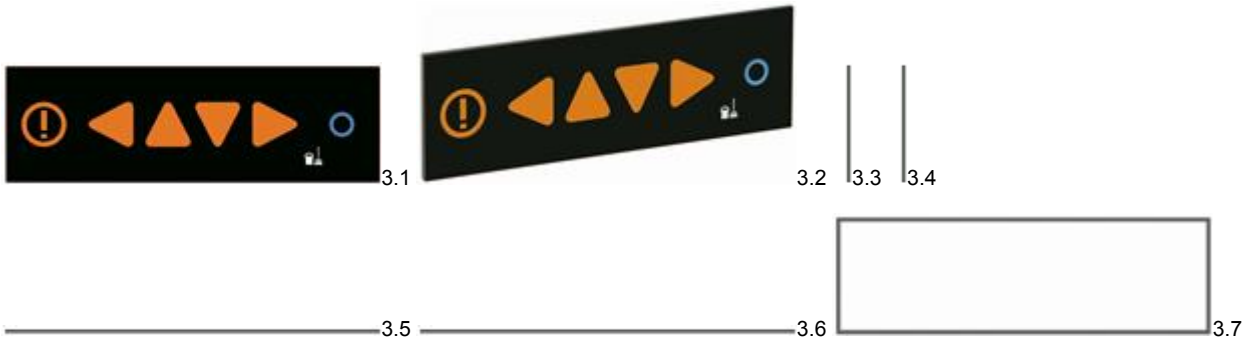

Design 4

- (54) **Produkt:** Panels for a reverse vending machine
- (51) **Klasse:** 20-01
- (72) **Designer:** Silje Sandahl Näs, c/o Tomra Systems ASA, Drengsrudhagen 2, 1372 ASKER
- (50) **Anmerkning:** Designet er farger.
- (55) **Designavbildninger:**

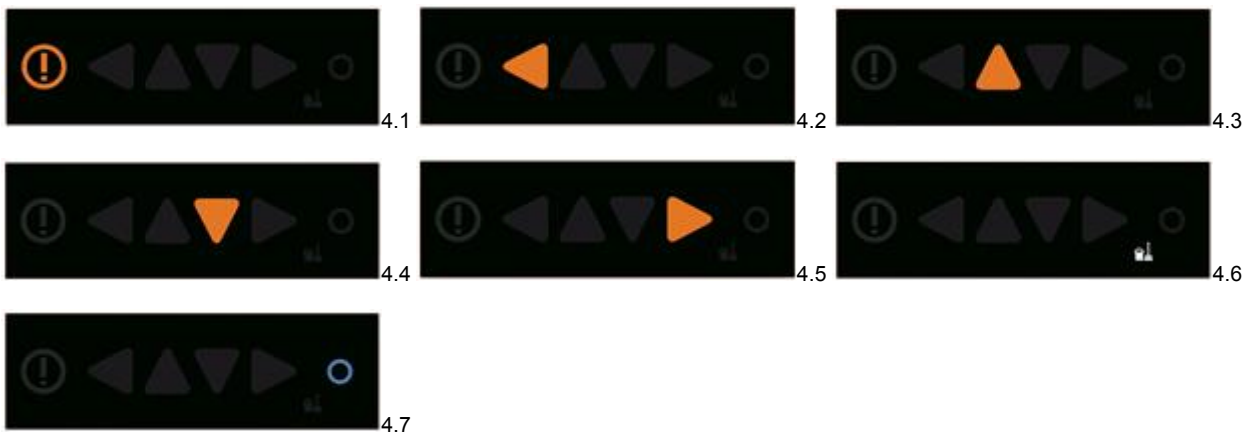

(11)	Reg.nr.:	DM/098630
(21)	Søkn.nr.:	20171212
(22)	Inngitt i WIPO:	2017.11.17
(15)	Registrert i WIPO:	2017.11.17
(24)	Løpedag:	2017.11.17
(43)	Allm. tilgj.:	2018.05.18
(15)	Besluttet gjeldende NO:	2018.06.27
(45)	Kunngjort NO:	2018.07.16
(18)	Reg. gjelder til:	2022.11.17
(73)	Innehaver:	Petit Bateau, 15, rue du Lieutenant Pierre Murard, FR-10000 TROYES, Frankrike

Design 1

(54)	Produkt:	Pajama
(51)	Klasse:	02-01
(72)	Designer:	Adélaïde D'Andigne, 81 Boulevard Saint Michel, 75005 PARIS, Frankrike (FR)
(55)	Designavbildninger:	

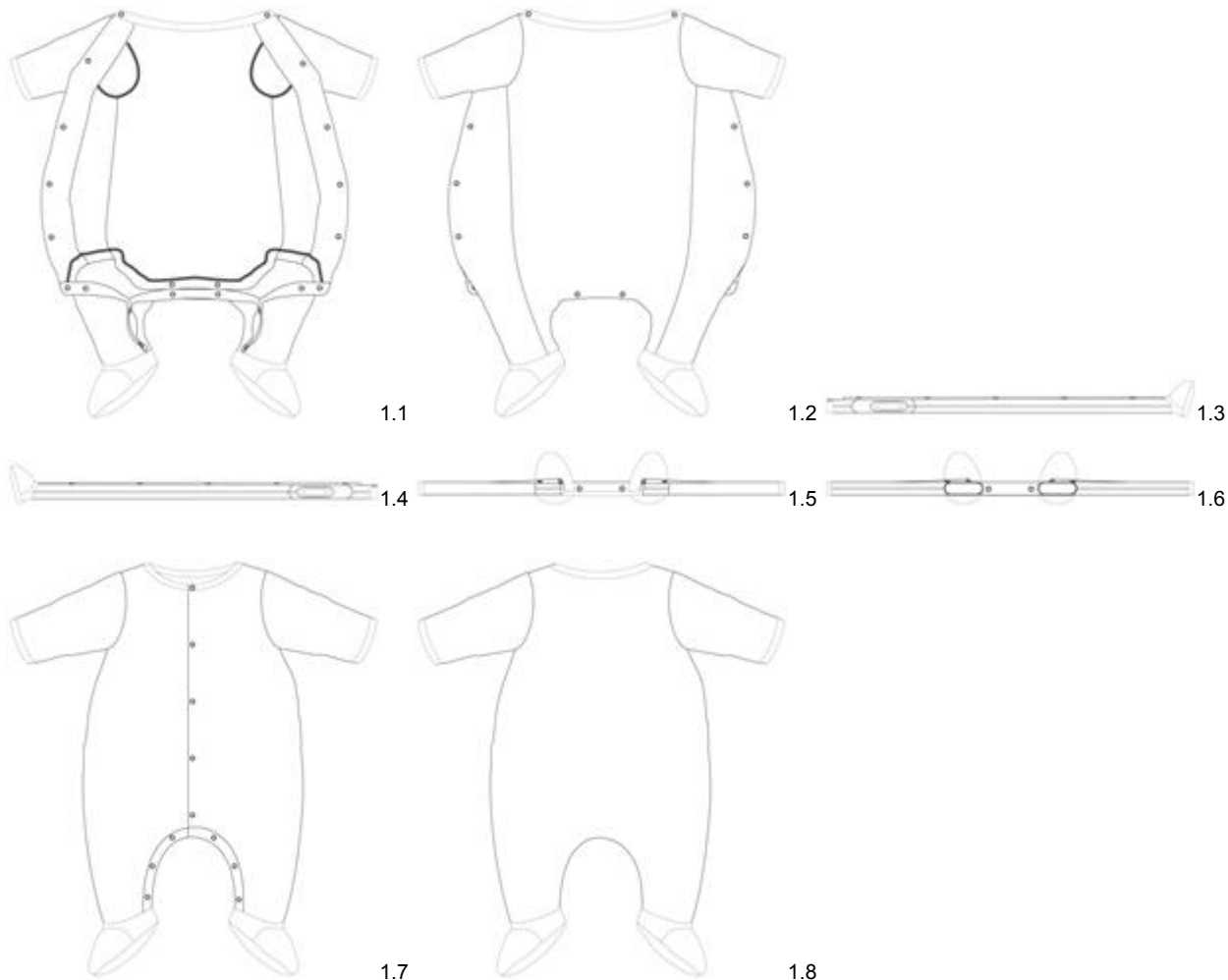

(11)	Reg.nr.:	DM/098635
(21)	Søkn.nr.:	20171214
(22)	Inngitt i WIPO:	2017.11.23
(15)	Registrert i WIPO:	2017.11.23
(24)	Løpedag:	2017.11.23
(43)	Allm. tilgj.:	2018.05.25
(15)	Besluttet gjeldende NO:	2018.06.27
(45)	Kunngjort NO:	2018.07.16
(18)	Reg. gjelder til:	2022.11.23
(73)	Innehaver:	SEAT, S.A., Autovia A-2, Km. 585, ES-08760 MARTORELL (BARCELONA), Spania
(50)	Anmerkninger:	Registreringen gjelder samregistrering.

Design 1

(54)	Produkt:	Automobile
(51)	Klasse:	12-08
(72)	Designer:	SEAT, S.A., Autovia A-2, Km. 585, 08760 MARTORELL (BARCELONA), Spania (ES)
(30)	Prioritet:	2017.05.25, EM, 004018430, 1, 2, 3, 4, 5, 6, 7, 8
(50)	Anmerkning:	Designet er i farger.
(55)	Designavbildninger:	



1.1



1.2



1.3



1.4



1.5



1.6

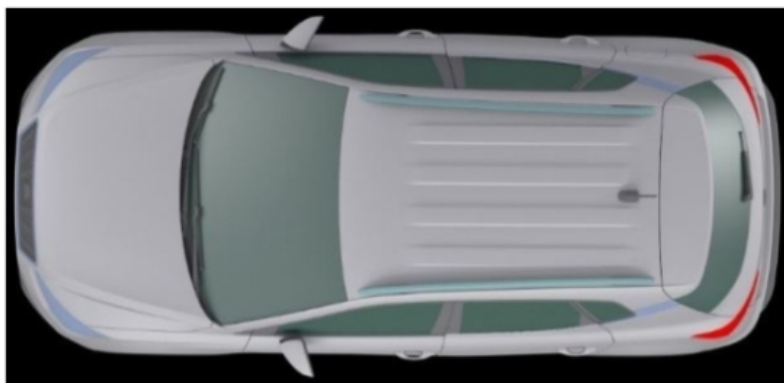

1.7

Design 2

- (54) **Produkt:** Decorative trim
 (51) **Klasse:** 12-16
 (72) **Designer:** SEAT, S.A., Autovia A-2, Km. 585, 08760 MARTORELL (BARCELONA), Spania (ES)
 (30) **Prioritet:** 2017.05.25, EM, 004018430, 1, 2, 3, 4, 5, 6, 7, 8
 (55) **Designavbildninger:**



2.1

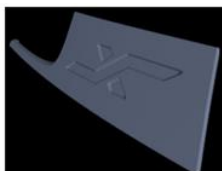

2.2

Design 3

- (54) **Produkt:** Full front bumpers
 (51) **Klasse:** 12-16
 (72) **Designer:** SEAT, S.A., Autovia A-2, Km. 585, 08760 MARTORELL (BARCELONA), Spania (ES)
 (30) **Prioritet:** 2017.05.25, EM, 004018430, 1, 2, 3, 4, 5, 6, 7, 8
 (50) **Anmerkning:** Designet er i farger.
 (55) **Designavbildninger:**



3.1



3.2

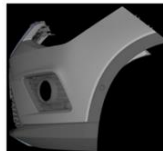

3.3



3.4

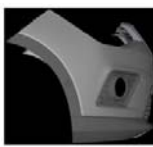

3.5



3.6



3.7

Design 4

- (54) **Produkt:** Full front bumpers
(51) **Klasse:** 12-16
(72) **Designer:** SEAT, S.A., Autovia A-2, Km. 585, 08760 MARTORELL (BARCELONA), Spania (ES)
(30) **Prioritet:** 2017.05.25, EM, 004018430, 1, 2, 3, 4, 5, 6, 7, 8
(50) **Anmerkning:** Designet er i farger.
(55) **Designavbildninger:**



4.1



4.2

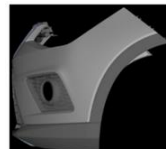

4.3



4.4

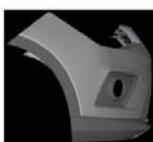

4.5



4.6



4.7

Design 5

- (54) **Produkt:** Full front bumpers
(51) **Klasse:** 12-16
(72) **Designer:** SEAT, S.A., Autovia A-2, Km. 585, 08760 MARTORELL (BARCELONA), Spania (ES)
(30) **Prioritet:** 2017.05.25, EM, 004018430, 1, 2, 3, 4, 5, 6, 7, 8
(55) **Designavbildninger:**



5.1



5.2

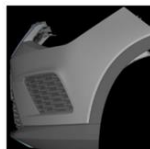

5.3



5.4



5.5



5.6

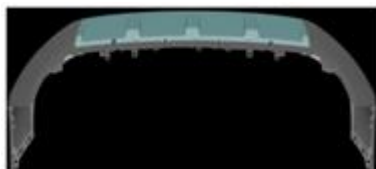

5.7

Design 6

- (54) **Produkt:** Full rear bumper
 (51) **Klasse:** 12-16
 (72) **Designer:** SEAT, S.A., Autovia A-2, Km. 585, 08760 MARTORELL (BARCELONA), Spania (ES)
 (30) **Prioritet:** 2017.05.25, EM, 004018430, 1, 2, 3, 4, 5, 6, 7, 8
 (50) **Anmerkning:** Designet er i farger.
 (55) **Designavbildninger:**

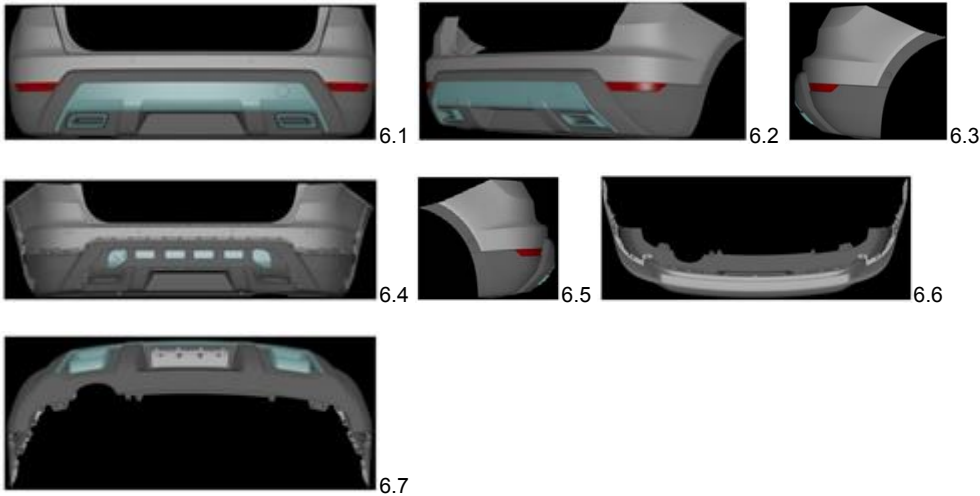
**Design 7**

- (54) **Produkt:** Vehicle air stream deflector
 (51) **Klasse:** 12-16
 (72) **Designer:** SEAT, S.A., Autovia A-2, Km. 585, 08760 MARTORELL (BARCELONA), Spania (ES)
 (30) **Prioritet:** 2017.05.25, EM, 004018430, 1, 2, 3, 4, 5, 6, 7, 8
 (50) **Anmerkning:** Designet er i farger.
 (55) **Designavbildninger:**

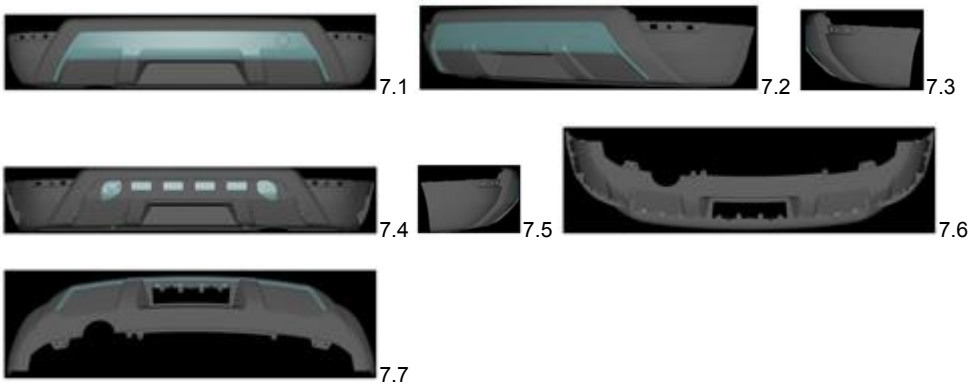
**Design 8**

- (54) **Produkt:** Full rear bumper
 (51) **Klasse:** 12-16
 (72) **Designer:** SEAT, S.A., Autovia A-2, Km. 585, 08760 MARTORELL (BARCELONA), Spania (ES)
 (30) **Prioritet:** 2017.05.25, EM, 004018430, 1, 2, 3, 4, 5, 6, 7, 8
 (50) **Anmerkning:** Designet er i farger.
 (55) **Designavbildninger:**





8.4



8.5

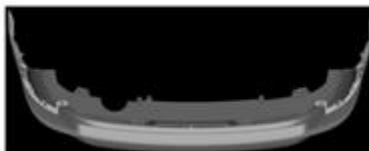

8.6



8.7

(11) Reg.nr.:	DM/098693
(21) Søkn.nr.:	20171208
(22) Inngitt i WIPO:	2017.11.13
(15) Registrert i WIPO:	2017.11.13
(24) Løpedag:	2017.11.13
(43) Allm. tilgj.:	2018.05.18
(15) Besluttet gjeldende NO:	2018.06.25
(45) Kunngjort NO:	2018.07.16
(18) Reg. gjelder til:	2022.11.13
(73) Innehaver:	Zweibrüder Optoelectronics GmbH & Co KG, Kronenstrasse 5-7, DE-42699 SOLINGEN, Tyskland Ledlenser GmbH & Co. KG, Kronenstrasse 5-7, DE-42699 SOLINGEN, Tyskland
(50) Anmerkninger:	Registreringen gjelder samregistrering.

Design 1

(54) Produkt:	Forehead lamps [e.g. for miners and speleologists]
(51) Klasse:	26-02
(72) Designer:	Andre Kunzendorfer, Froweinstrasse 17, 42105 WUPPERTAL, Tyskland (DE)
(55) Designavbildninger:	

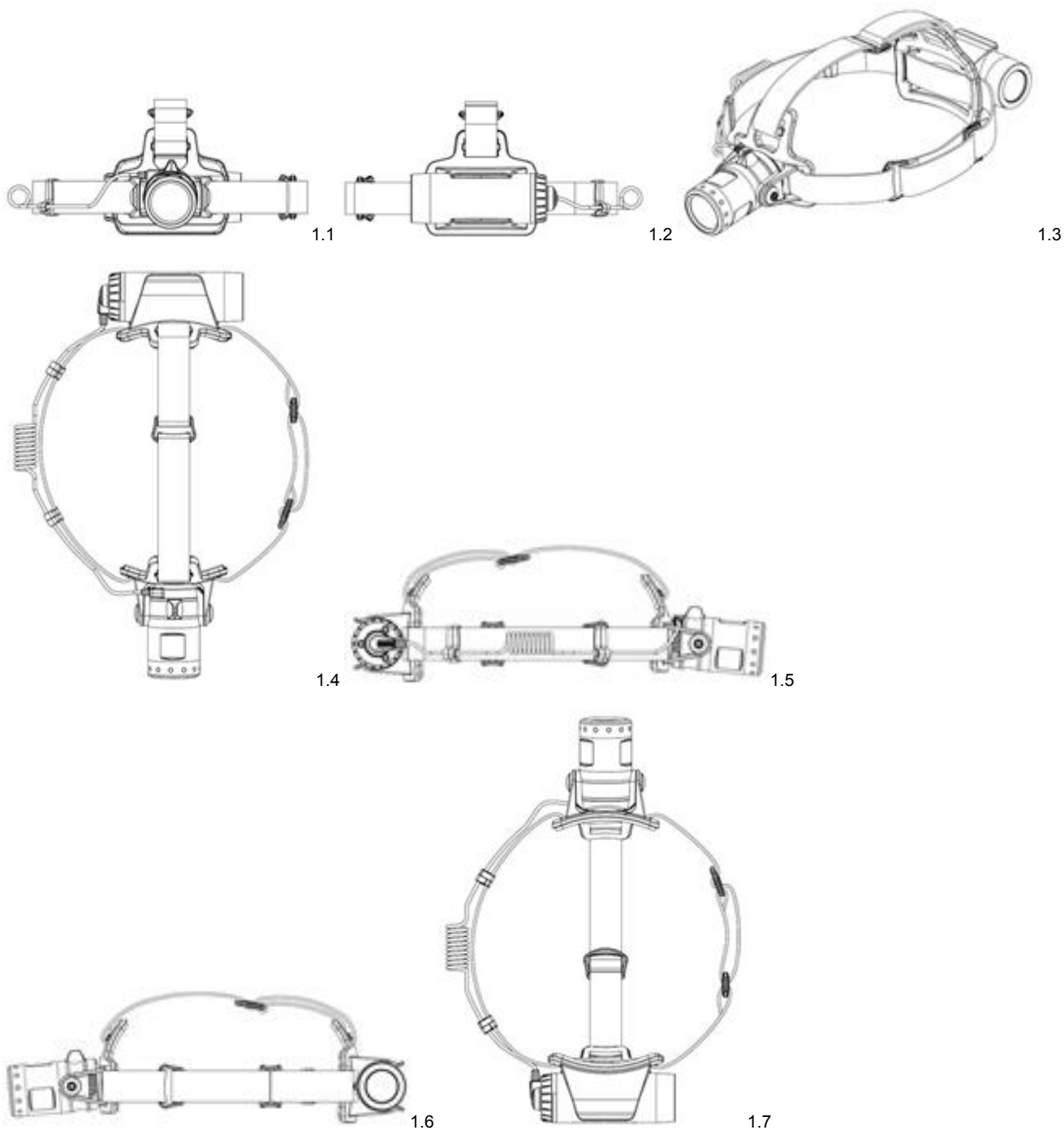

Design 2

- (54) **Produkt:** Forehead lamps [e.g. for miners and speleologists]
 (51) **Klasse:** 26-02
 (72) **Designer:** Andre Kunzendorfer, Froweinstrasse 17, 42105 WUPPERTAL, Tyskland (DE)
 (50) **Anmerkning:** Designet er i farger.
 (55) **Designavbildninger:**



2.1



2.2



2.3



2.4

Design 3

- (54) **Produkt:** Forehead lamps [e.g. for miners and speleologists]
 (51) **Klasse:** 26-02
 (72) **Designer:** Andre Kunzendorfer, Froweinstrasse 17, 42105 WUPPERTAL, Tyskland (DE)
 (50) **Anmerkning:** Designet er i farger.
 (55) **Designavbildninger:**



3.1



3.2



3.3



3.4



3.5



3.6



3.7

Design 4

- (54) **Produkt:** Forehead lamps [e.g. for miners and speleologists]
(51) **Klasse:** 26-02
(72) **Designer:** Andre Kunzendorfer, Froweinstrasse 17, 42105 WUPPERTAL, Tyskland (DE)
(55) **Designavbildninger:**

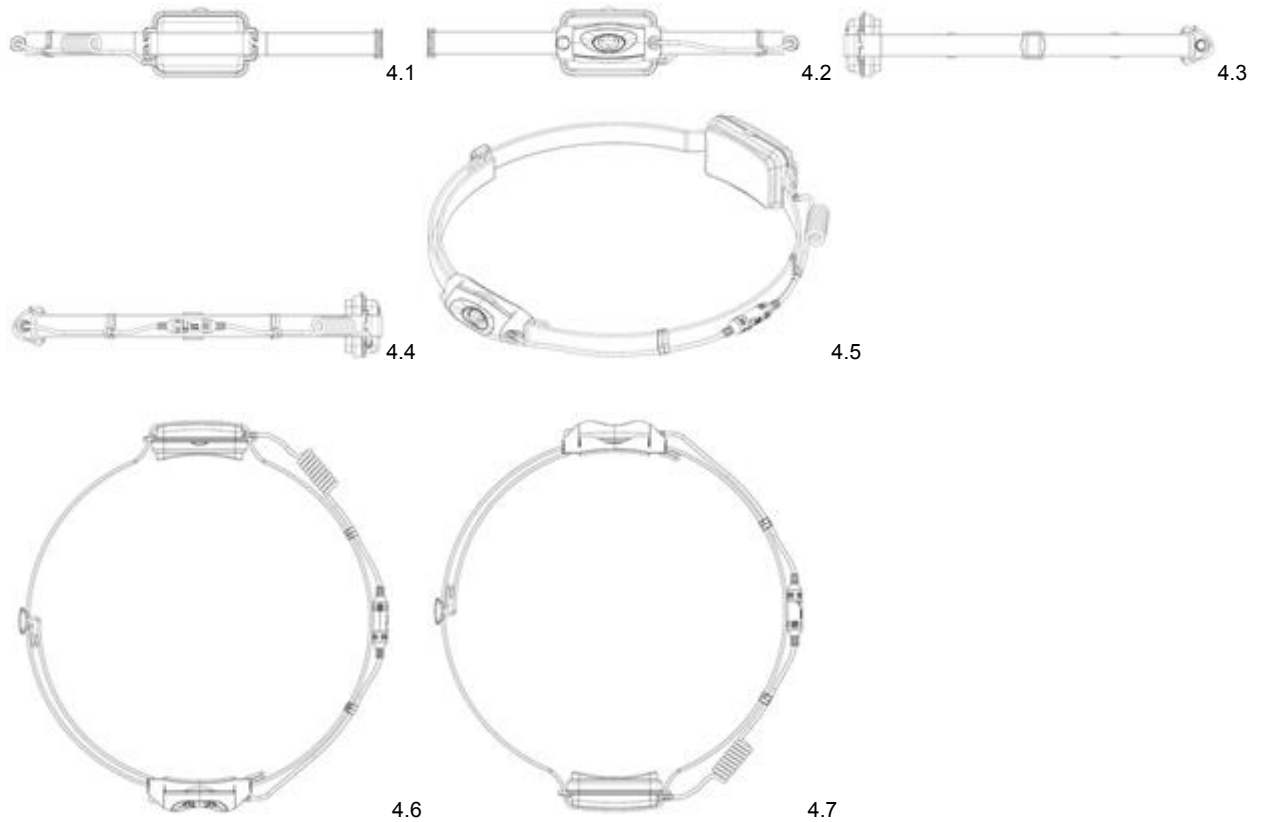

(11) Reg.nr.:	DM/098769
(21) Søkn.nr.:	20180039
(22) Inngitt i WIPO:	2017.11.14
(15) Registrert i WIPO:	2017.11.14
(24) Løpedag:	2017.11.14
(43) Allm. tilgj.:	2018.05.18
(15) Besluttet gjeldende NO:	2018.06.27
(45) Kunngjort NO:	2018.07.16
(18) Reg. gjelder til:	2022.11.14
(73) Innehaver:	TRISTEL PLC, Unit 4C, Lynx Business Park, Fordham Road, GB-CB87NY SNAILWELL, NEWMARKET, Storbritannia
(50) Anmerkninger:	Registreringen gjelder samregistrering.

Design 1

(54) Produkt:	Spray bottles
(51) Klasse:	09-01
(72) Designer:	Paul Swinney, Unit 4C, Lynx Business Park, Fordham Road, CB87NY SNAILWELL, NEWMARKET, Storbritannia (GB) Elizabeth Dixon, Unit 4C, Lynx Business Park, Fordham Road, CB87NY SNAILWELL, NEWMARKET, Storbritannia (GB) Jeremy Turner, 22 McDonnell Street, 3114 OMOROKOA, New Zealand (NZ)
(30) Prioritet:	2017.05.19, EM, 004008779, 1, 2
(55) Designavbildninger:	

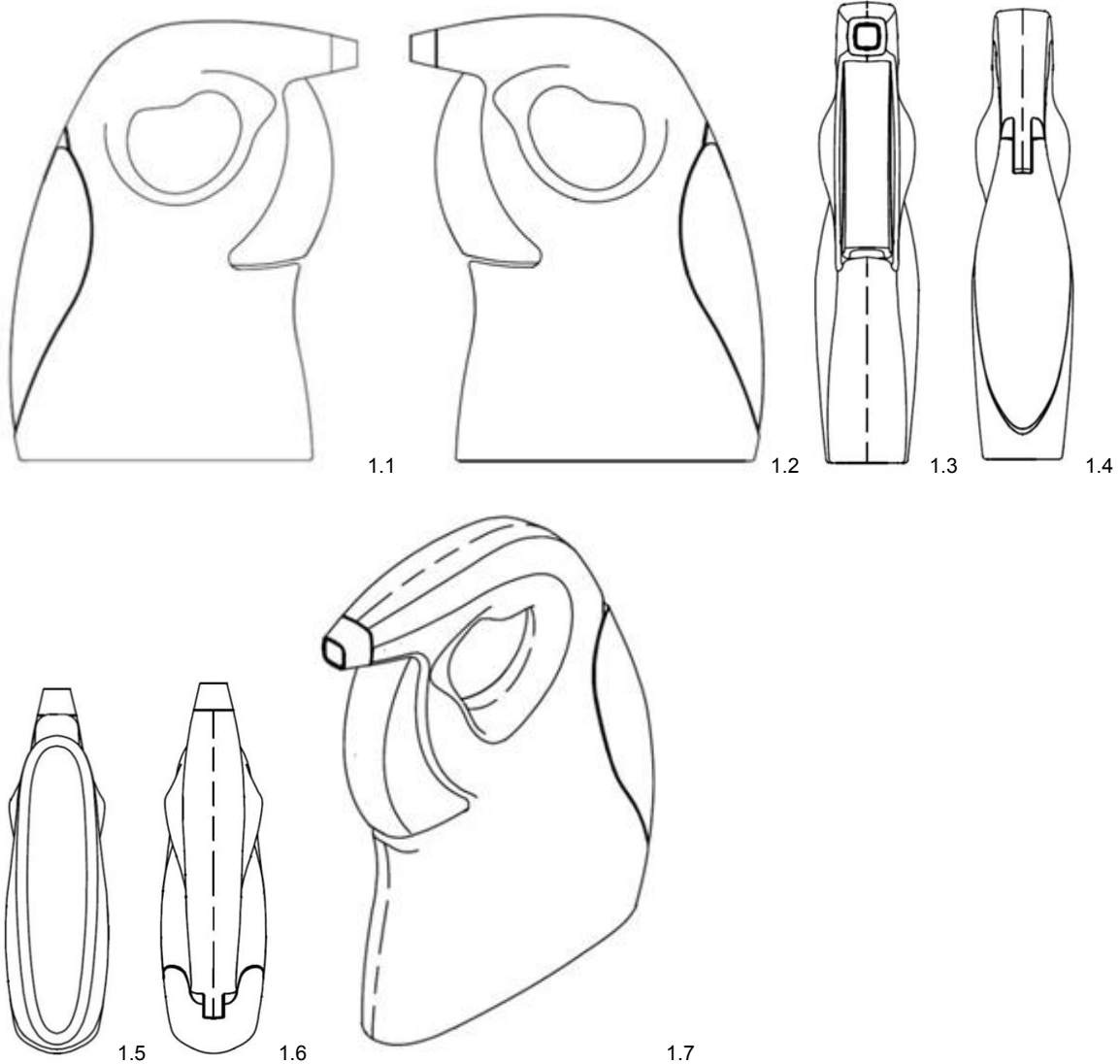

Design 2

- (54) **Produkt:** Spray bottles
(51) **Klasse:** 09-01
(72) **Designer:** Paul Swinney, Unit 4C, Lynx Business Park, Fordham Road, CB87NY SNAILWELL, NEWMARKET, Storbritannia (GB)
Elizabeth Dixon, Unit 4C, Lynx Business Park, Fordham Road, CB87NY SNAILWELL, NEWMARKET, Storbritannia (GB)
Jeremy Turner, 22 McDonnell Street, 3114 OMOROKOA, New Zealand (NZ)
2017.05.19, EM, 004008779, 1, 2
- (30) **Prioritet:**
(55) **Designavbildninger:**

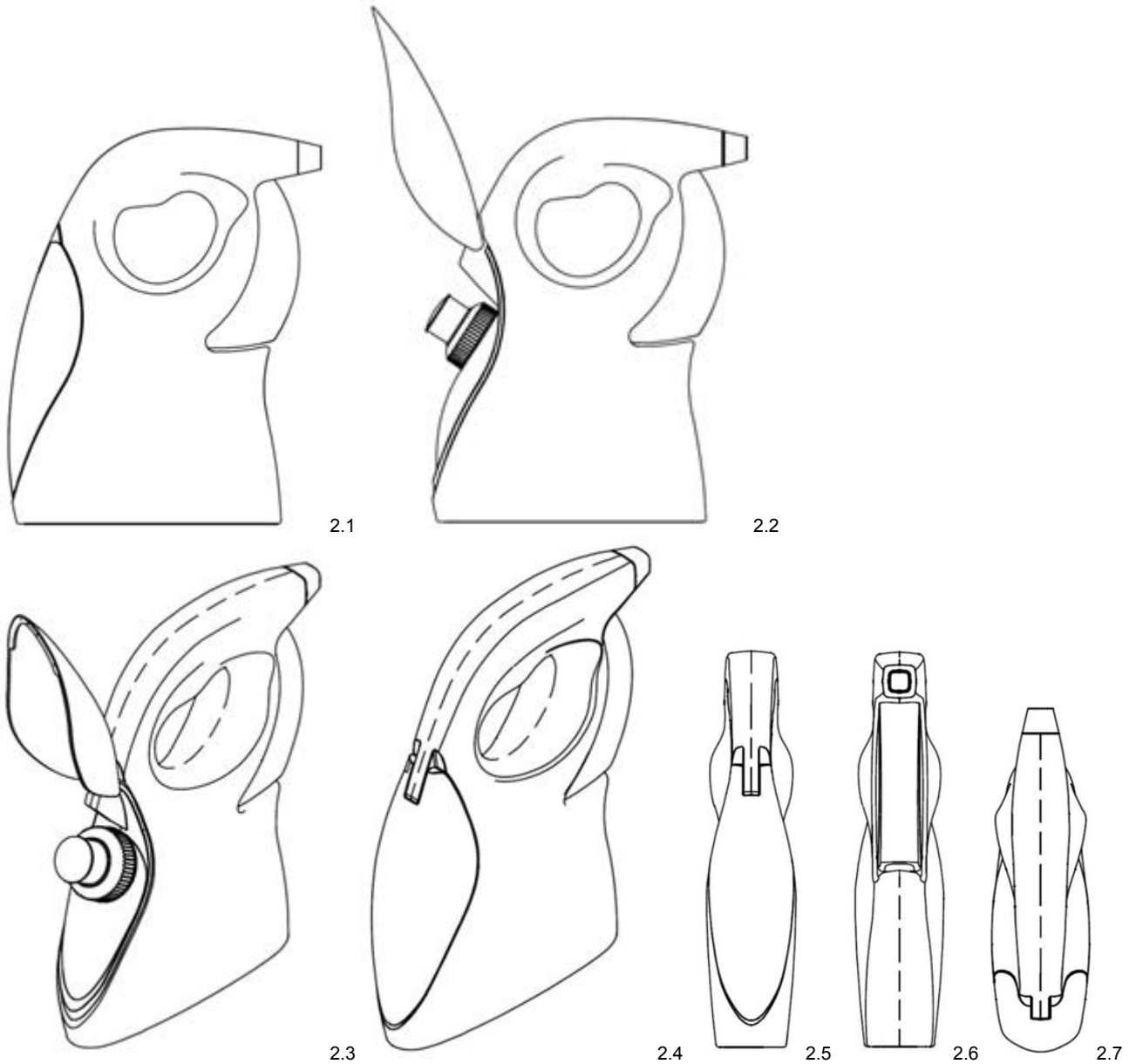

(11)	Reg.nr.:	DM/098853
(21)	Søkn.nr.:	20180038
(22)	Inngitt i WIPO:	2017.11.13
(15)	Registrert i WIPO:	2017.11.13
(24)	Løpedag:	2017.11.13
(43)	Allm. tilgj.:	2018.05.18
(15)	Besluttet gjeldende NO:	2018.06.27
(45)	Kunngjort NO:	2018.07.16
(18)	Reg. gjelder til:	2022.11.13
(73)	Innehaver:	Koninklijke Philips N.V., High Tech Campus 5, NL-5656AE EINDHOVEN, Nederland
(50)	Anmerkninger:	Registreringen gjelder samregistrering.

Design 1

(54)	Produkt:	Garment stand steamer without ironing board
(51)	Klasse:	07-05
(72)	Designer:	Peter Jonathan Smith, Veerstraat 4 III, 1075ST AMSTERDAM, Nederland (NL) Wenwen Yang, Leidsekruisstraat 17, 1017RE AMSTERDAM, Nederland (NL)
(30)	Prioritet:	2017.05.15, EM, 004001816, 1, 2, 3, 4
(55)	Designavbildninger:	

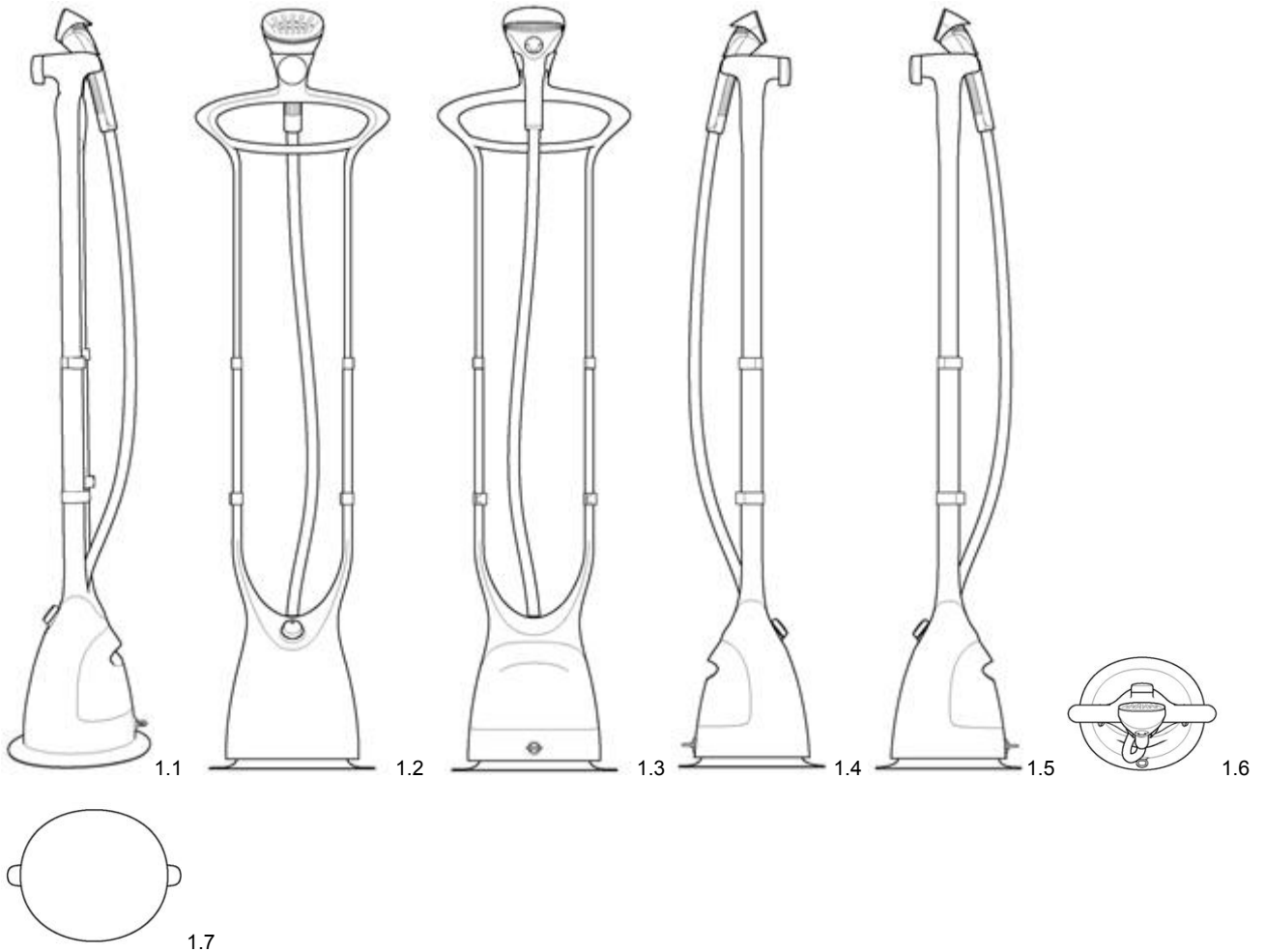

Design 2

- (54) **Produkt:** Garment stand steamer with ironing board
07-05
(51) **Klasse:**
(72) **Designer:** Peter Jonathan Smith, Veerstraat 4 III, 1075ST AMSTERDAM, Nederland (NL)
Wenwen Yang, Leidsekruistraat 17, 1017RE AMSTERDAM, Nederland (NL)
(30) **Prioritet:** 2017.05.15, EM, 004001816, 1, 2, 3, 4
(55) **Designavbildninger:**

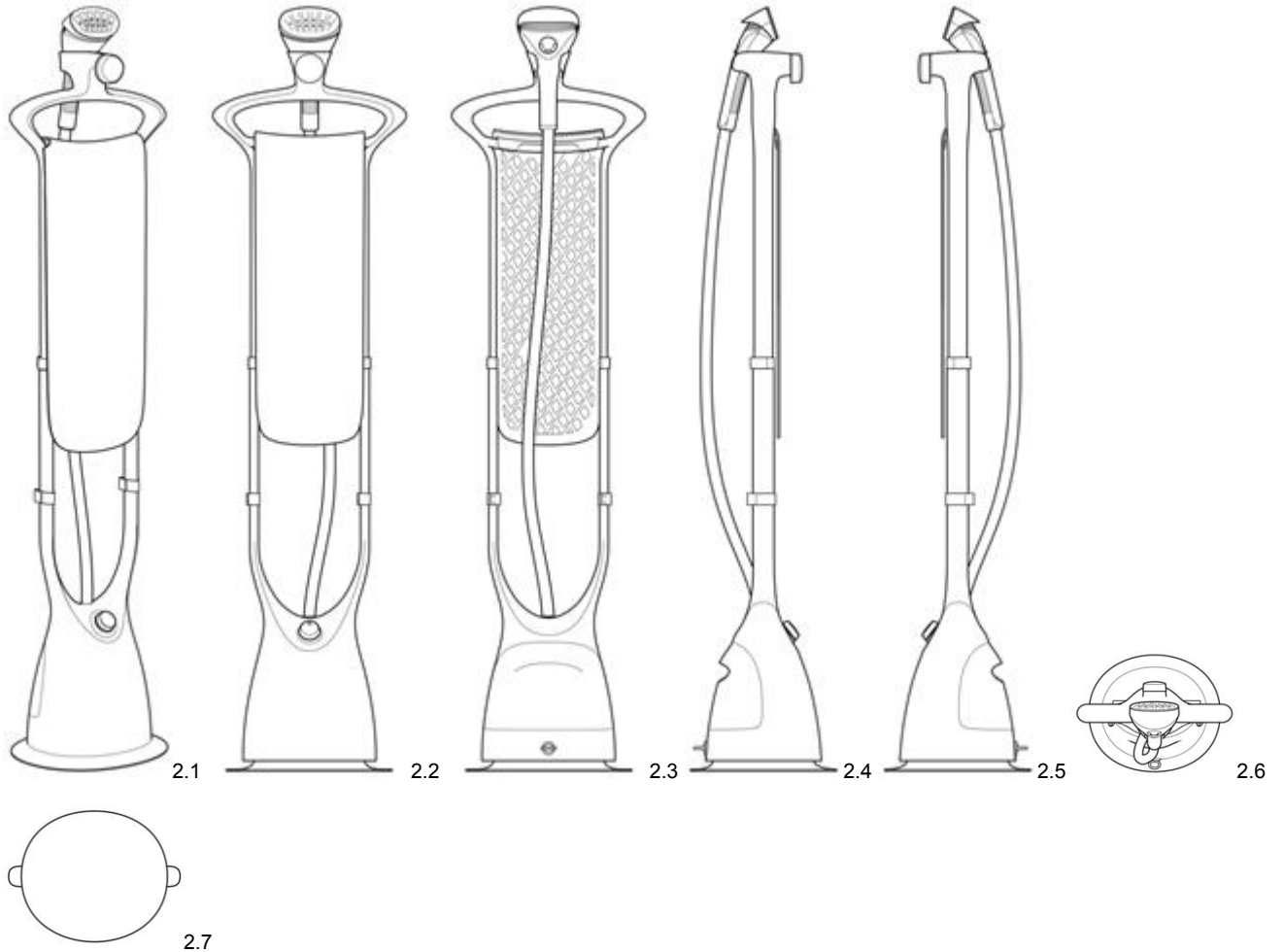

Design 3

- (54) **Produkt:** Steamer head for garment stand steamer
(51) **Klasse:** 07-05
(72) **Designer:** Peter Jonathan Smith, Veerstraat 4 III, 1075ST AMSTERDAM, Nederland (NL)
Wenwen Yang, Leidsekruisstraat 17, 1017RE AMSTERDAM, Nederland (NL)
(30) **Prioritet:** 2017.05.15, EM, 004001816, 1, 2, 3, 4
(55) **Designavbildninger:**

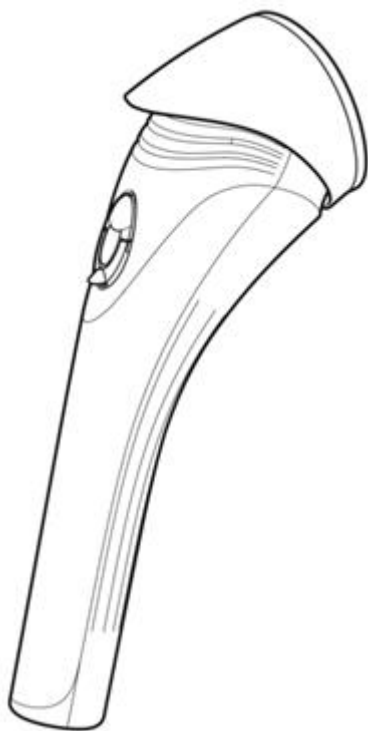

3.1

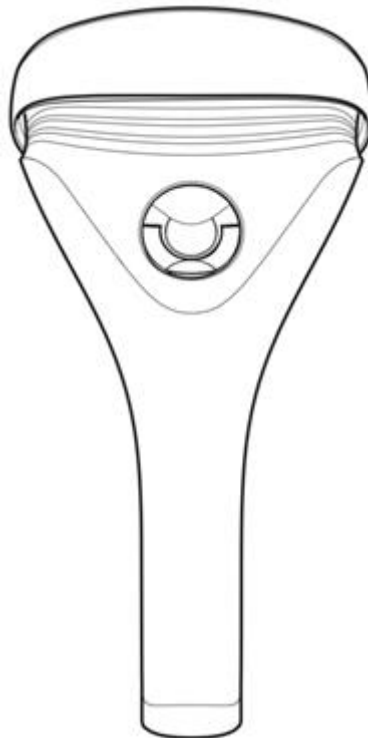

3.2

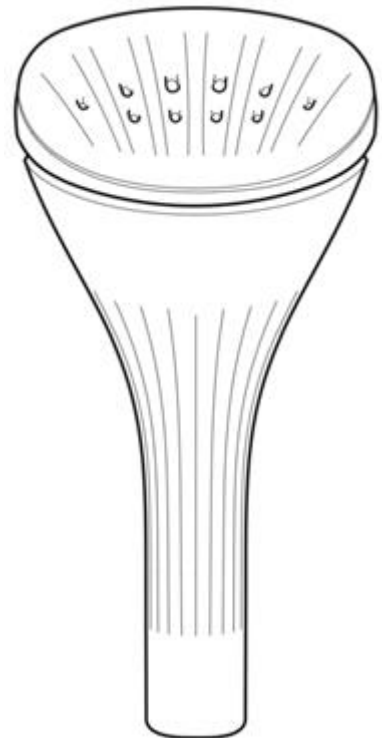

3.3



3.4



3.5



3.6



3.7

Design 4

- (54) **Produkt:** Garment stand steamer with ironing board
- (51) **Klasse:** 07-05
- (72) **Designer:** Peter Jonathan Smith, Veerstraat 4 III, 1075ST AMSTERDAM, Nederland (NL)
Wenwen Yang, Leidsekruistraat 17, 1017RE AMSTERDAM, Nederland (NL)
- (30) **Prioritet:** 2017.05.15, EM, 004001816, 1, 2, 3, 4
- (55) **Designavbildninger:**

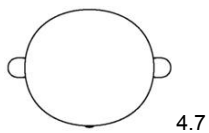
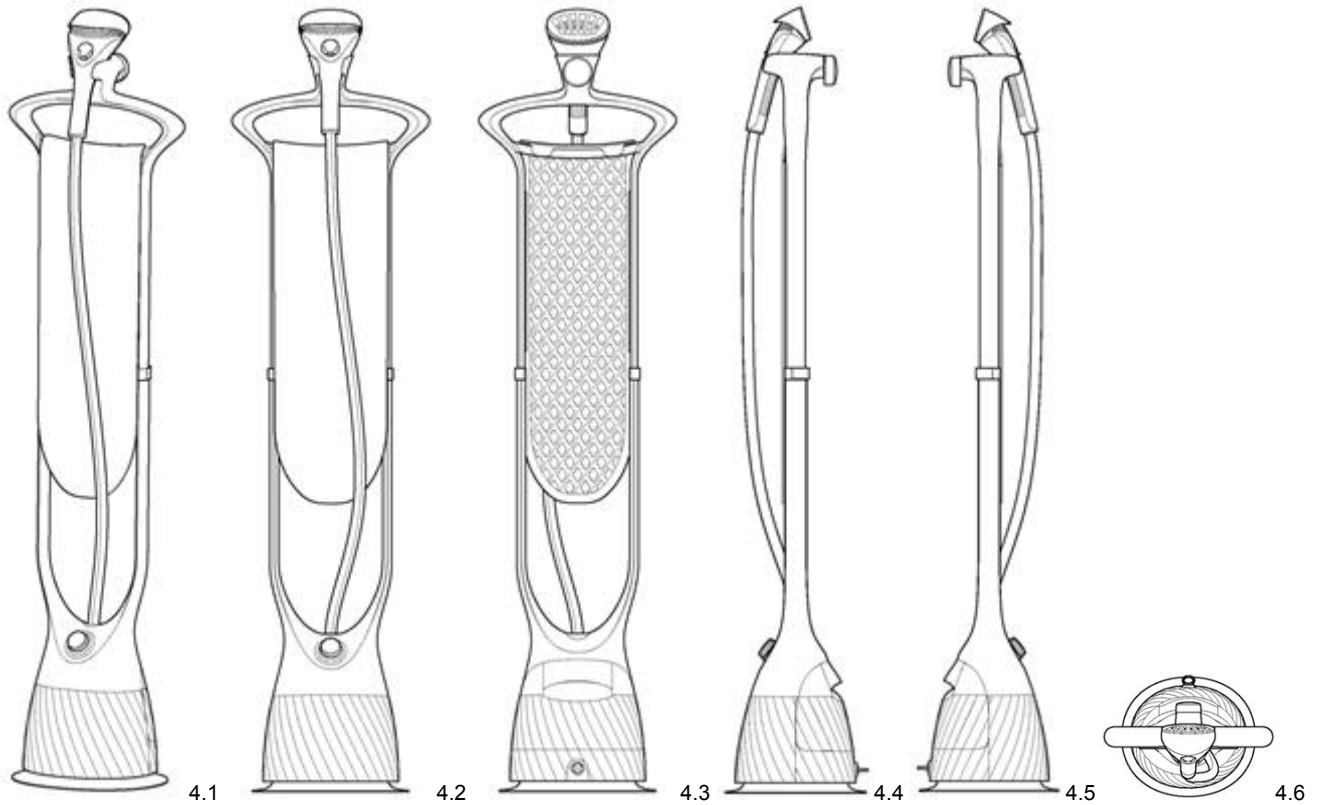

4.7

(11)	Reg.nr.:	DM/098878
(21)	Søkn.nr.:	20180043
(22)	Inngitt i WIPO:	2017.11.28
(15)	Registrert i WIPO:	2017.11.28
(24)	Løpedag:	2017.11.28
(43)	Allm. tilgj.:	2018.06.01
(15)	Besluttet gjeldende NO:	2018.06.27
(45)	Kunngjort NO:	2018.07.16
(18)	Reg. gjelder til:	2022.11.28
(73)	Innehaver:	Rosti Mepal Support B.V., Aalsvoort 101, NL-7241MB LOCHEM, Nederland

Design 1

(54)	Produkt:	Drinking bottle
(51)	Klasse:	09-01
(72)	Designer:	Johan Weernink, Loohof 14, 7478BL DIEPENHEIM, Nederland (NL)
(55)	Designavbildninger:	





1.5

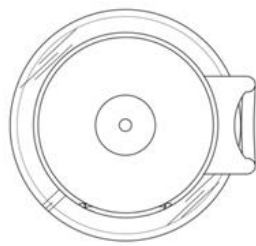

1.6

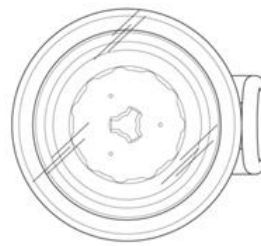

1.7

(11)	Reg.nr.:	DM/098881
(21)	Søkn.nr.:	20180036
(22)	Inngitt i WIPO:	2017.11.09
(15)	Registrert i WIPO:	2017.11.09
(24)	Løpedag:	2017.11.09
(43)	Allm. tilgj.:	2018.05.11
(15)	Besluttet gjeldende NO:	2018.06.18
(45)	Kunngjort NO:	2018.07.16
(18)	Reg. gjelder til:	2022.11.09
(73)	Innehaver:	BAC GMBH BLUE AQUA COLOGNE, Am Zollhafen 24, DE-50678 KÖLN, Tyskland
(50)	Anmerkninger:	Registreringen gjelder samregistrering.

Design 1

(54)	Produkt:	Water dispensers
(51)	Klasse:	20-01
(72)	Designer:	Cyrril Haas, Mittelweg 16, 60318 FRANKFURT AM MAIN, Tyskland (DE)
(30)	Prioritet:	2017.05.16, EM, 004003242, 1, 2
(50)	Anmerkning:	Designet er i farger.
(55)	Designavbildninger:	



1.1



1.2



1.3



1.4



1.5



1.6



1.7



1.8



1.9



1.10

Design 2

- (54) **Produkt:** Water dispensers
(51) **Klasse:** 20-01
(72) **Designer:** Cyrill Haas, Mittelweg 16, 60318 FRANKFURT AM MAIN, Tyskland (DE)
(30) **Prioritet:** 2017.05.16, EM, 004003242, 1, 2
(50) **Anmerking:** Designet er i farger.
(55) **Designavbildninger:**



2.1



2.2



2.3



2.4



2.5



2.6



2.7



2.8



2.9



2.10

(11)	Reg.nr.:	DM/098885
(21)	Søkn.nr.:	20180040
(22)	Inngitt i WIPO:	2017.11.16
(15)	Registrert i WIPO:	2017.11.16
(24)	Løpedag:	2017.11.16
(43)	Allm. tilgj.:	2018.05.18
(15)	Besluttet gjeldende NO:	2018.06.27
(45)	Kunngjort NO:	2018.07.16
(18)	Reg. gjelder til:	2022.11.16
(73)	Innehaver:	Nabeel Shaibani, Hardwick House, 21 Lilestone Street, GB-NW88TE LONDON, Storbritannia

Design 1

(54)	Produkt:	Shopping trolley bag
(51)	Klasse:	03-01
(72)	Designer:	Nabeel Shaibani, Hardwick House, 21 Lilestone Street, NW88TE LONDON, Storbritannia (GB)
(55)	Designavbildninger:	

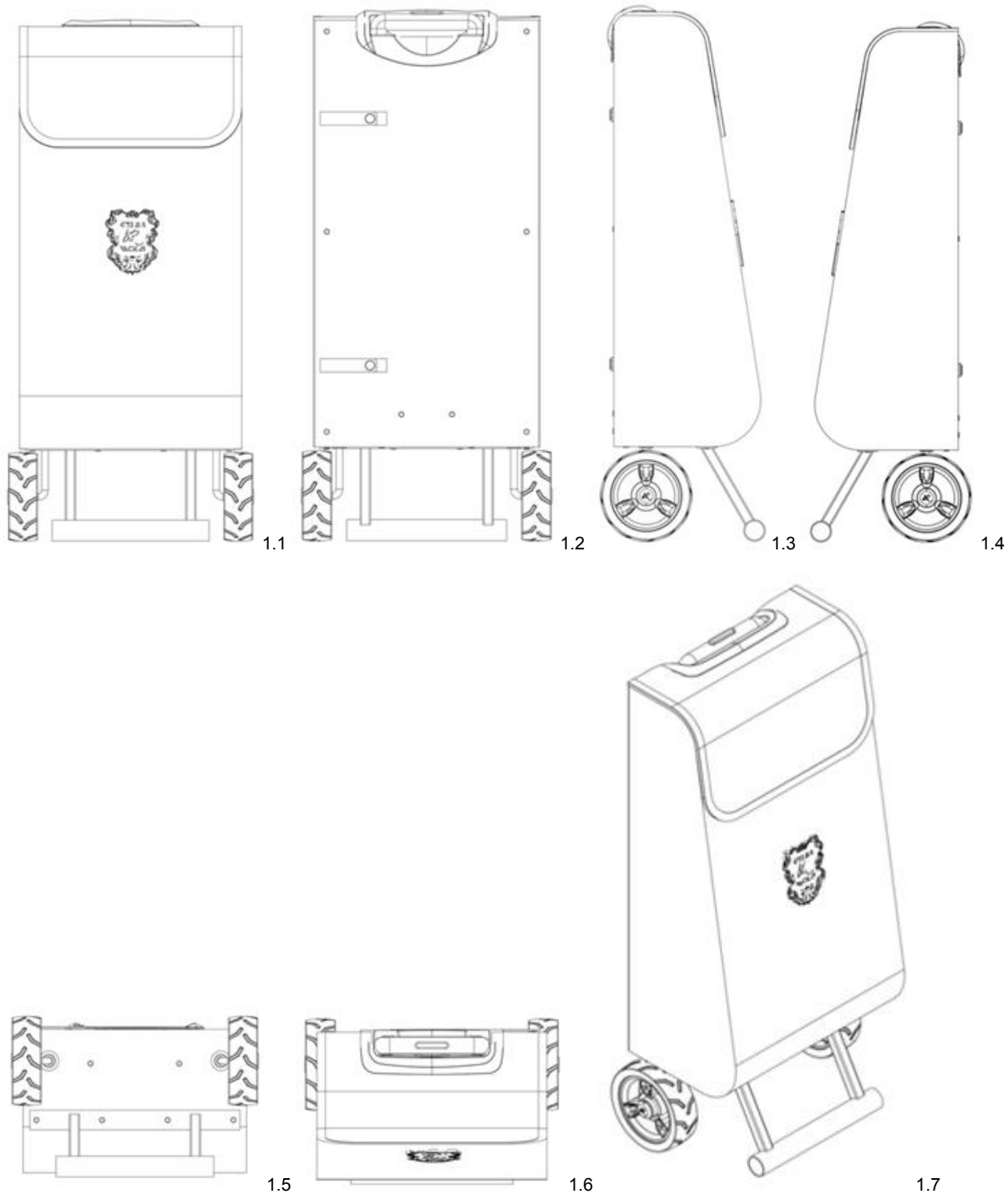

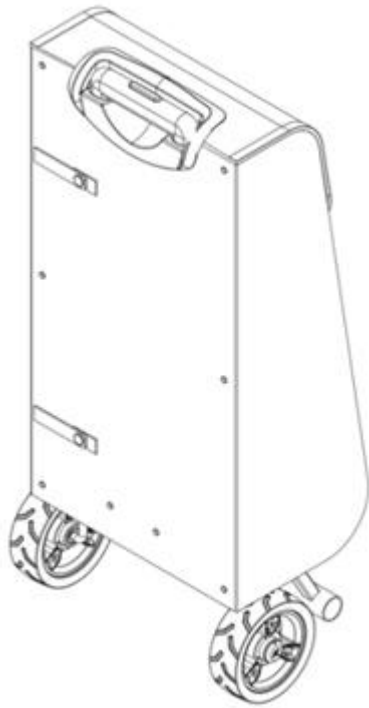

1.8

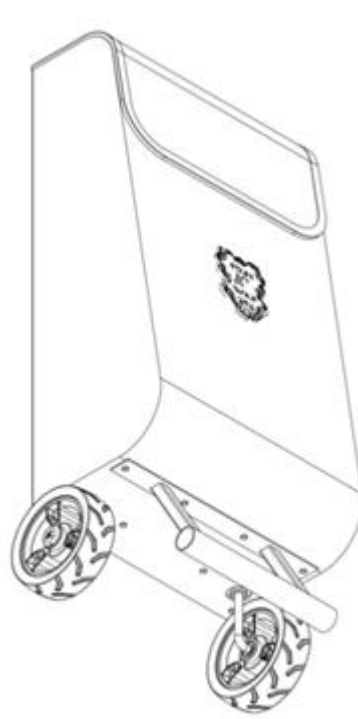

1.9

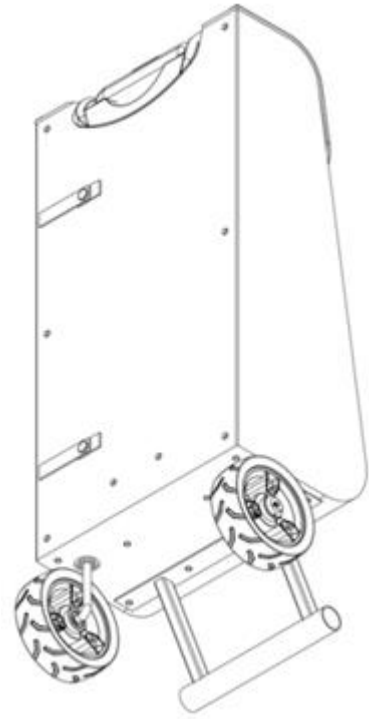

1.10

(11) Reg.nr.:	DM/098995
(21) Søkn.nr.:	20180053
(22) Inngitt i WIPO:	2017.12.12
(15) Registrert i WIPO:	2017.12.12
(24) Løpedag:	2017.12.12
(43) Allm. tilgj.:	2018.06.15
(15) Besluttet gjeldende NO:	2018.06.25
(45) Kunngjort NO:	2018.07.16
(18) Reg. gjelder til:	2022.12.12
(73) Innehaver:	Koninklijke Philips N.V., High Tech Campus 5, NL-5656AE EINDHOVEN, Nederland
(50) Anmerkninger:	Registreringen gjelder samregistrering.

Design 1

(54) Produkt:	Solar kettles
(51) Klasse:	07-02
(72) Designer:	Waikit Chung, Gu Yi Lu 99, 2, 1801 shi, 200235 SHANGHAI, Kina (CN)
(30) Prioritet:	2017.06.29, EM, 004073005, 1, 2
(55) Designavbildninger:	



1.1

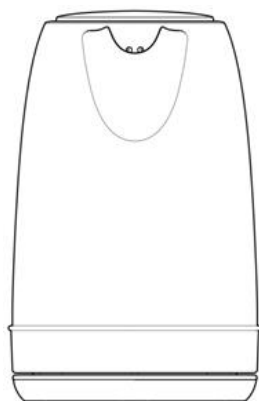

1.2

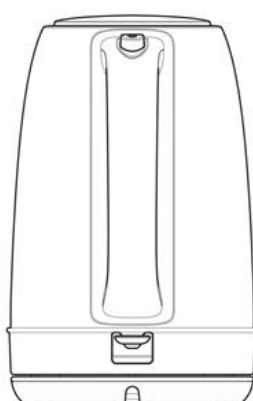

1.3



1.4



1.5



1.6

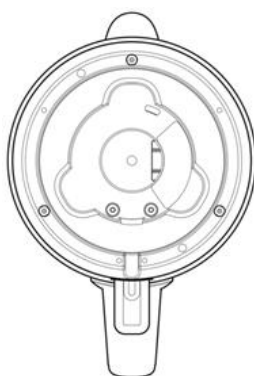

1.7

Design 2

- (54) **Produkt:** Solar kettles
(51) **Klasse:** 07-02
(72) **Designer:** Waikit Chung, Gu Yi Lu 99, 2, 1801 shi, 200235 SHANGHAI, Kina (CN)
(30) **Prioritet:** 2017.06.29, EM, 004073005, 1, 2
(55) **Designavbildninger:**



2.1

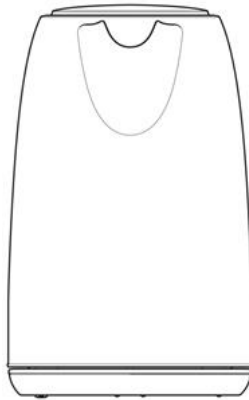

2.2

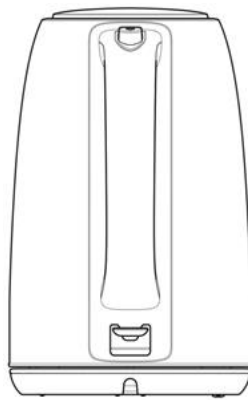

2.3



2.4



2.5

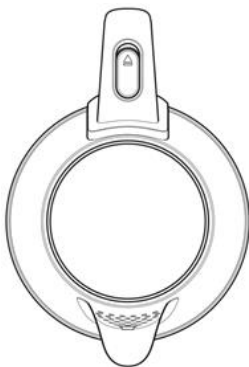

2.6

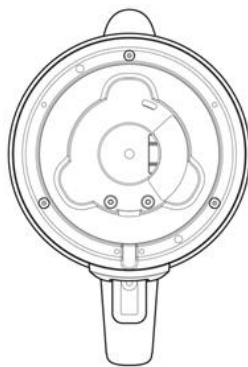

2.7

(11) Reg.nr.:	DM/099093
(21) Søkn.nr.:	20180006
(22) Inngitt i WIPO:	2017.12.20
(15) Registrert i WIPO:	2017.12.20
(24) Løpedag:	2017.12.20
(43) Allm. tilgj.:	2018.01.05
(15) Besluttet gjeldende NO:	2018.06.28
(45) Kunngjort NO:	2018.07.16
(18) Reg. gjelder til:	2022.12.20
(73) Innehaver:	SIMU, Zone Industrielle, Arc-les-Gray, FR-70100 GRAY, Frankrike
(50) Anmerkninger:	Registreringen gjelder samregistrering.

Design 1

(54) Produkt:	Switches
(51) Klasse:	13-03
(72) Designer:	Clément Peney, 13 Chemin de sainte reine, 70130 FRESNE SAINT MAMES, Frankrike (FR)
(55) Designavbildninger:	

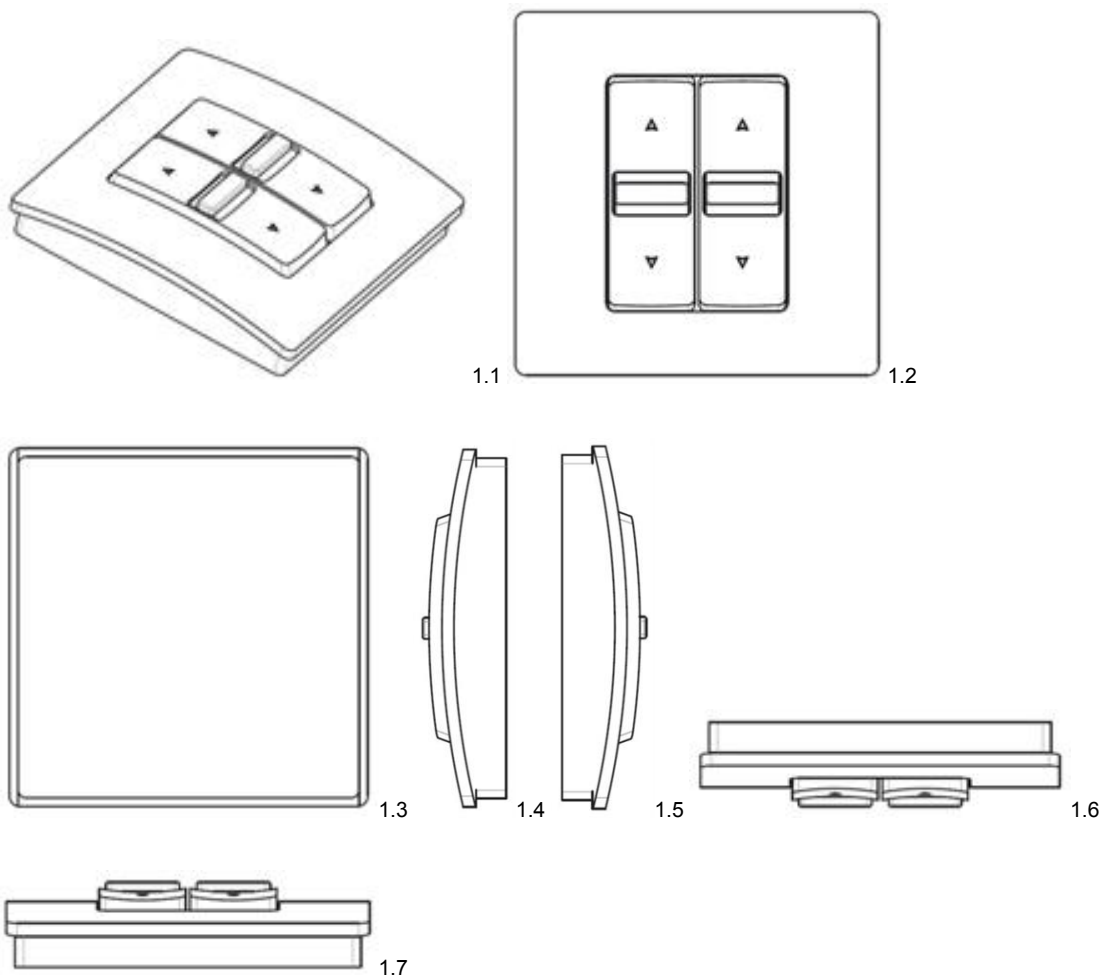

Design 2

- (54) **Produkt:** Switches
(51) **Klasse:** 13-03
(72) **Designer:** Clément Peney, 13 Chemin de sainte reine, 70130 FRESNE SAINT MAMES, Frankrike (FR)
(55) **Designavbildninger:**

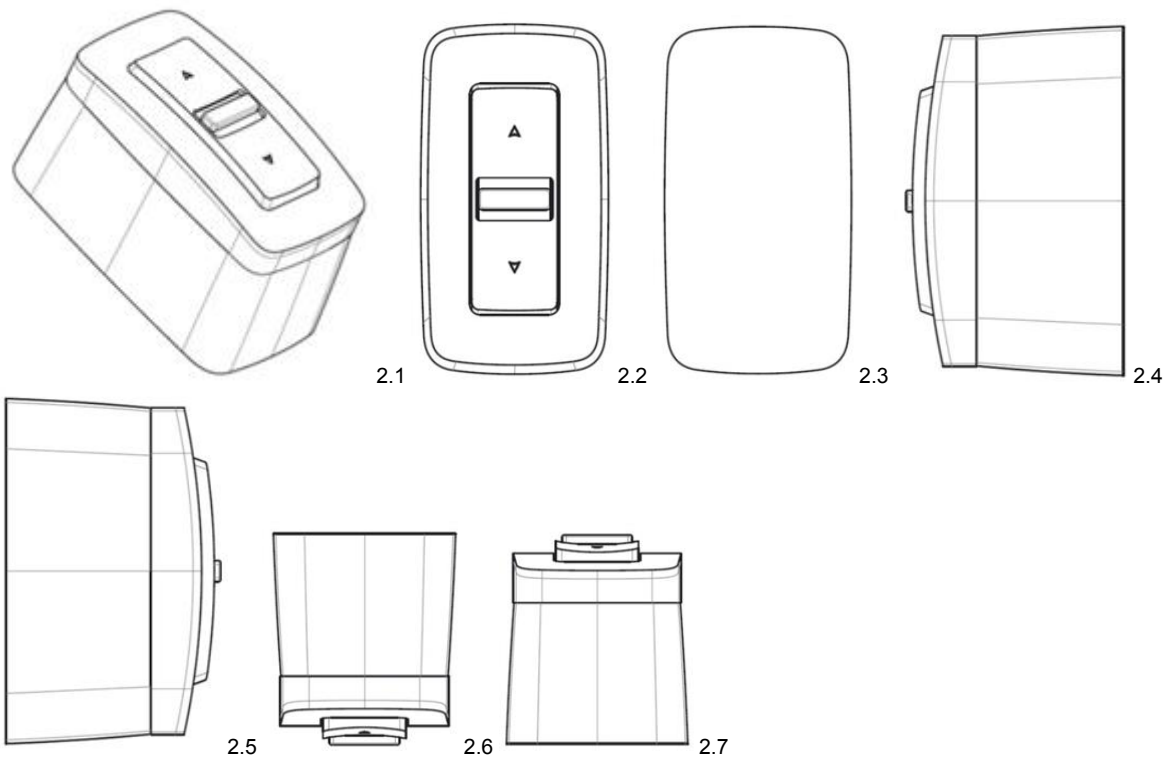
**Design 3**

- (54) **Produkt:** Switches
(51) **Klasse:** 13-03
(72) **Designer:** Clément Peney, 13 Chemin de sainte reine, 70130 FRESNE SAINT MAMES, Frankrike (FR)
(55) **Designavbildninger:**

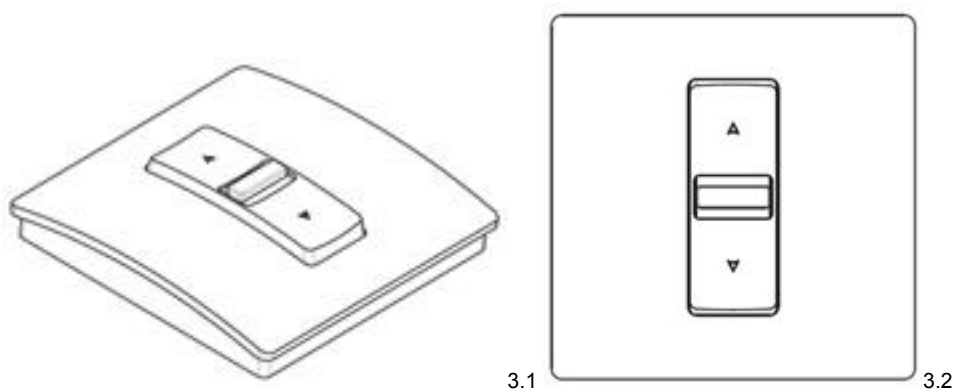

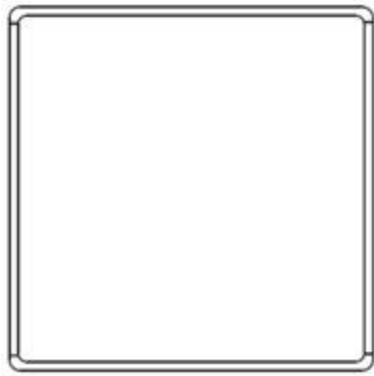

3.3

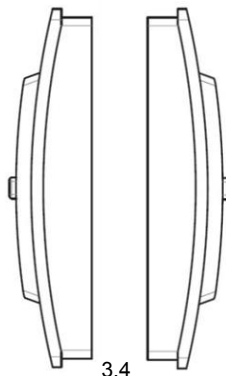

3.4

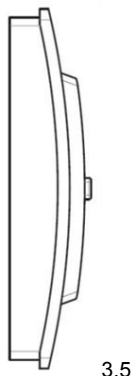

3.5

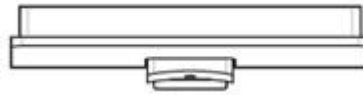

3.6



3.7

(11)	Reg.nr.:	DM/099270
(21)	Søkn.nr.:	20180156
(22)	Inngitt i WIPO:	2017.11.08
(15)	Registrert i WIPO:	2017.11.08
(24)	Løpedag:	2017.11.08
(43)	Allm. tilgj.:	2018.05.11
(15)	Besluttet gjeldende NO:	2018.06.20
(45)	Kunngjort NO:	2018.07.16
(18)	Reg. gjelder til:	2022.11.08
(73)	Innehaver:	CURT G. JOA, INC., 100 Crocker Avenue, US-WI53085 SHEBOYGAN FALLS, USA
(50)	Anmerkninger:	Registreringen gjelder samregistrering.

Design 1

(54)	Produkt:	Parts of a machine brake for use in minimizing rethreading of broken elastic
(51)	Klasse:	15-99
(72)	Designer:	Jeffrey W. Fritz, N4989 Country Aire Road, WI53073 PLYMOUTH, USA (US)
(30)	Prioritet:	2017.05.11, US, 29/603,632, 1
(55)	Designavbildninger:	

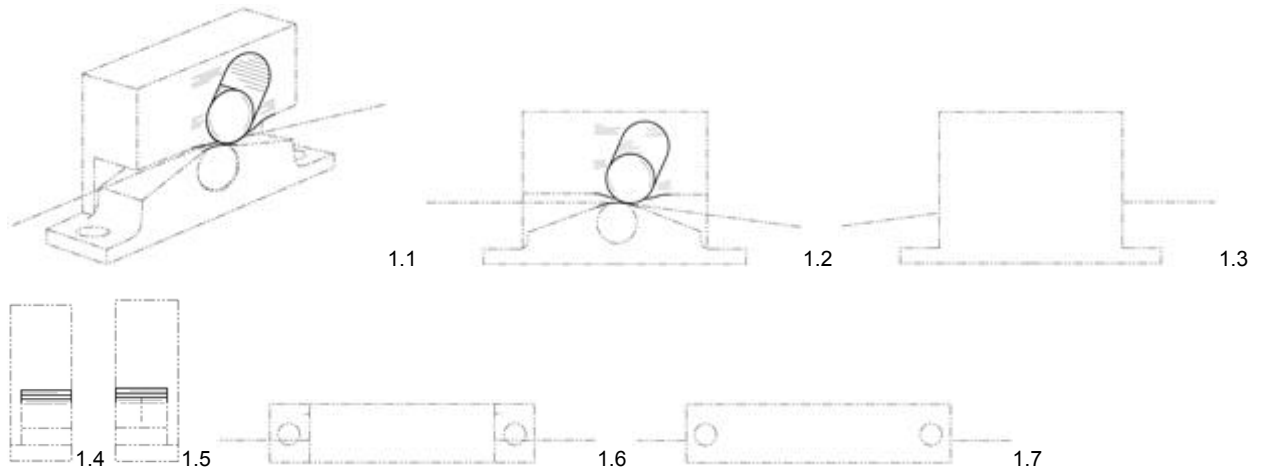
**Design 2**

(54)	Produkt:	Parts of a machine brake for use in minimizing rethreading of broken elastic
(51)	Klasse:	15-99
(72)	Designer:	Jeffrey W. Fritz, N4989 Country Aire Road, WI53073 PLYMOUTH, USA (US)
(30)	Prioritet:	2017.05.11, US, 29/603,634, 2
(55)	Designavbildninger:	

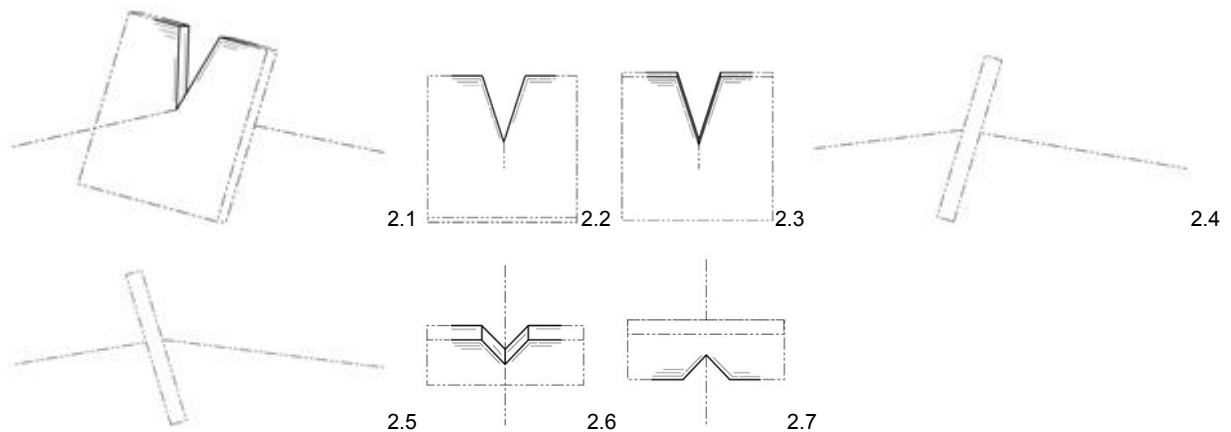

(11)	Reg.nr.:	DM/099427
(21)	Søkn.nr.:	20180155
(22)	Inngitt i WIPO:	2017.11.07
(15)	Registrert i WIPO:	2017.11.07
(24)	Løpedag:	2017.11.07
(43)	Allm. tilgj.:	2018.05.11
(15)	Besluttet gjeldende NO:	2018.06.20
(45)	Kunngjort NO:	2018.07.16
(18)	Reg. gjelder til:	2022.11.07
(73)	Innehaver:	BREMA MARKETING GMBH & CO. KG, Luebkemannstr. 7, DE-28876 OYTEN, Tyskland
(50)	Anmerkninger:	Registreringen gjelder samregistrering.

Design 1

(54)	Produkt:	Garden seats
(51)	Klasse:	06-01
(72)	Designer:	Thomas Berg, Harsefelder Strasse 13, 28205 BREMEN, Tyskland (DE)
(55)	Designavbildninger:	



1.1



1.2

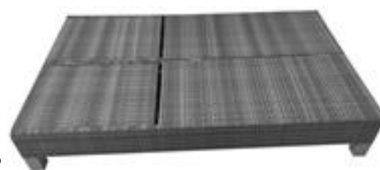

1.3



1.4



1.5



1.6



1.7



1.8

Design 2

- (54) **Produkt:** Garden seats
(51) **Klasse:** 06-01
(72) **Designer:** Thomas Berg, Harsefelder Strasse 13, 28205 BREMEN, Tyskland (DE)
(55) **Designavbildninger:**

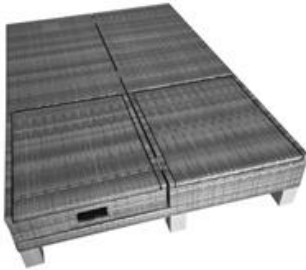

2.1



2.2

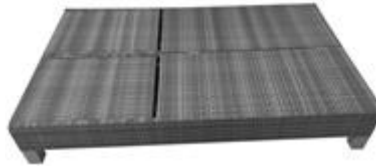

2.3

Design 3

- (54) **Produkt:** Garden seats
(51) **Klasse:** 06-01
(72) **Designer:** Thomas Berg, Harsefelder Strasse 13, 28205 BREMEN, Tyskland (DE)
(55) **Designavbildninger:**



3.1

Design 4

- (54) **Produkt:** Garden seats
(51) **Klasse:** 06-01
(72) **Designer:** Thomas Berg, Harsefelder Strasse 13, 28205 BREMEN, Tyskland (DE)
(55) **Designavbildninger:**



4.1



4.2



4.3



4.4

(11)	Reg.nr.:	DM/099988
(21)	Søkn.nr.:	20180365
(22)	Inngitt i WIPO:	2017.11.08
(15)	Registrert i WIPO:	2017.11.08
(24)	Løpedag:	2017.11.08
(43)	Allm. tilgj.:	2018.05.11
(15)	Besluttet gjeldende NO:	2018.06.25
(45)	Kunngjort NO:	2018.07.16
(18)	Reg. gjelder til:	2022.11.08
(73)	Innehaver:	Philip Morris Products S.A., Quai Jeanrenaud 3, CH-2000 NEUCHÂTEL, Sveits
(50)	Anmerkninger:	Registreringen gjelder samregistrering.

Design 1

(54)	Produkt:	Lighters for tobacco heat sticks and aerosol generators
(51)	Klasse:	27-05
(72)	Designer:	Florent Cuchet, Jaktvarvsplan 3, 11236 STOCKHOLM, Sverige (SE) Kyungil Chung, 111 Silchester Park GLENAGEARY, CO. DUBLIN, Irland (IE) Philip Nilsson, 10 Quinsborough Road, A98 NN92 BRAY, CO WICKLOW, Irland (IE)
(30)	Prioritet:	2017.05.26, EM, 004020394, 1, 2, 3
(55)	Designavbildninger:	

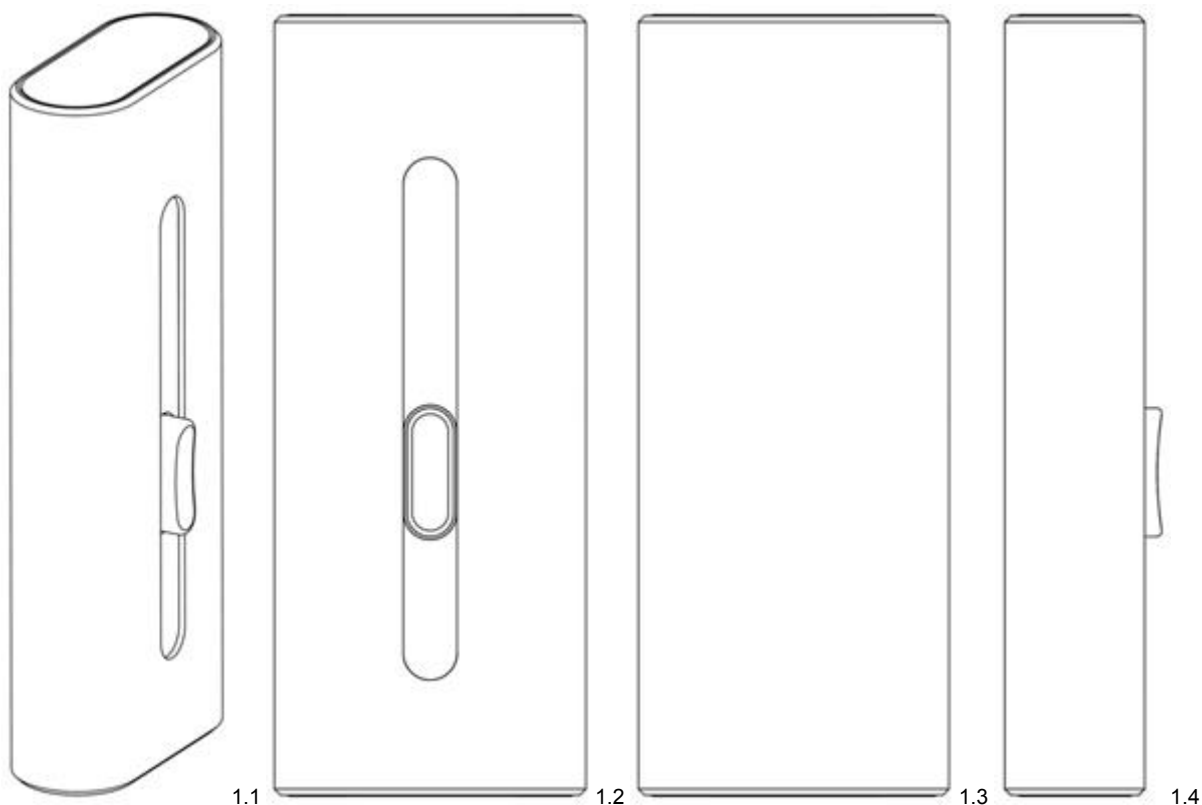

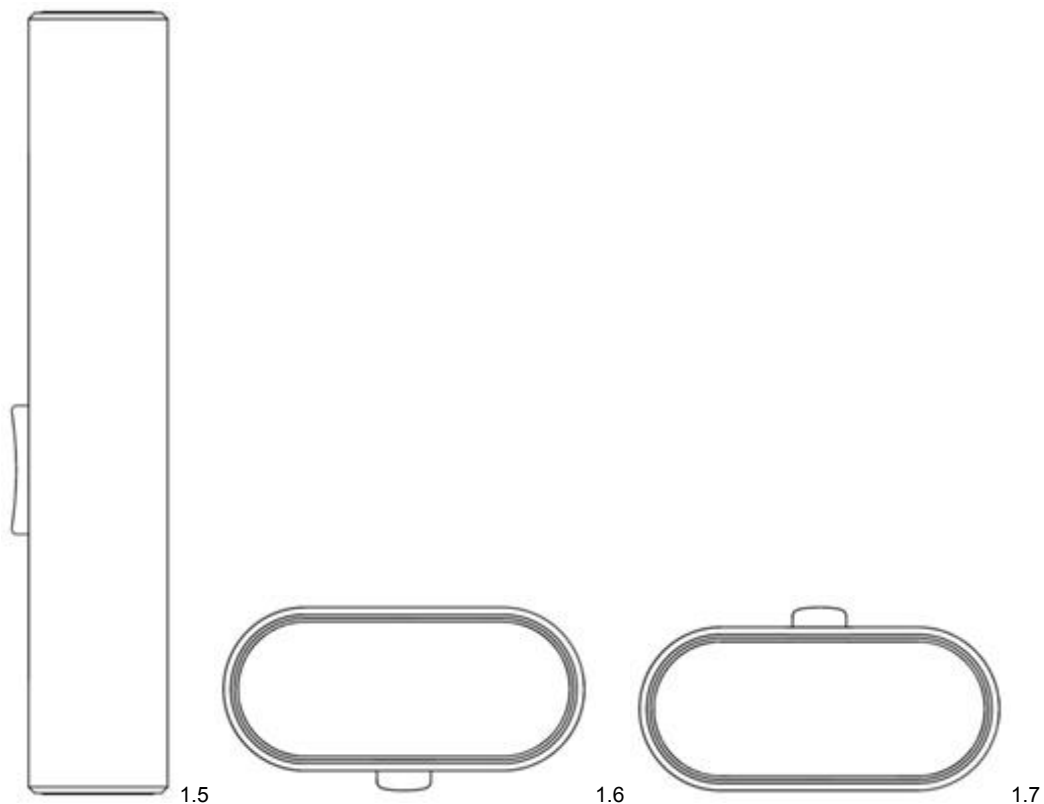
**Design 2**

- (54) **Produkt:** Lighters for tobacco heat sticks and aerosol generators
 (51) **Klasse:** 27-05
 (72) **Designer:** Florent Cuchet, Jaktvarvsplan 3, 11236 STOCKHOLM, Sverige (SE)
 Kyungil Chung, 111 Silchester Park GLENAGEARY, CO. DUBLIN, Irland (IE)
 Philip Nilsson, 10 Quinsborough Road, A98 NN92 BRAY, CO WICKLOW, Irland (IE)
 (30) **Prioritet:** 2017.05.26, EM, 004020394, 1, 2, 3
 (55) **Designavbildninger:**

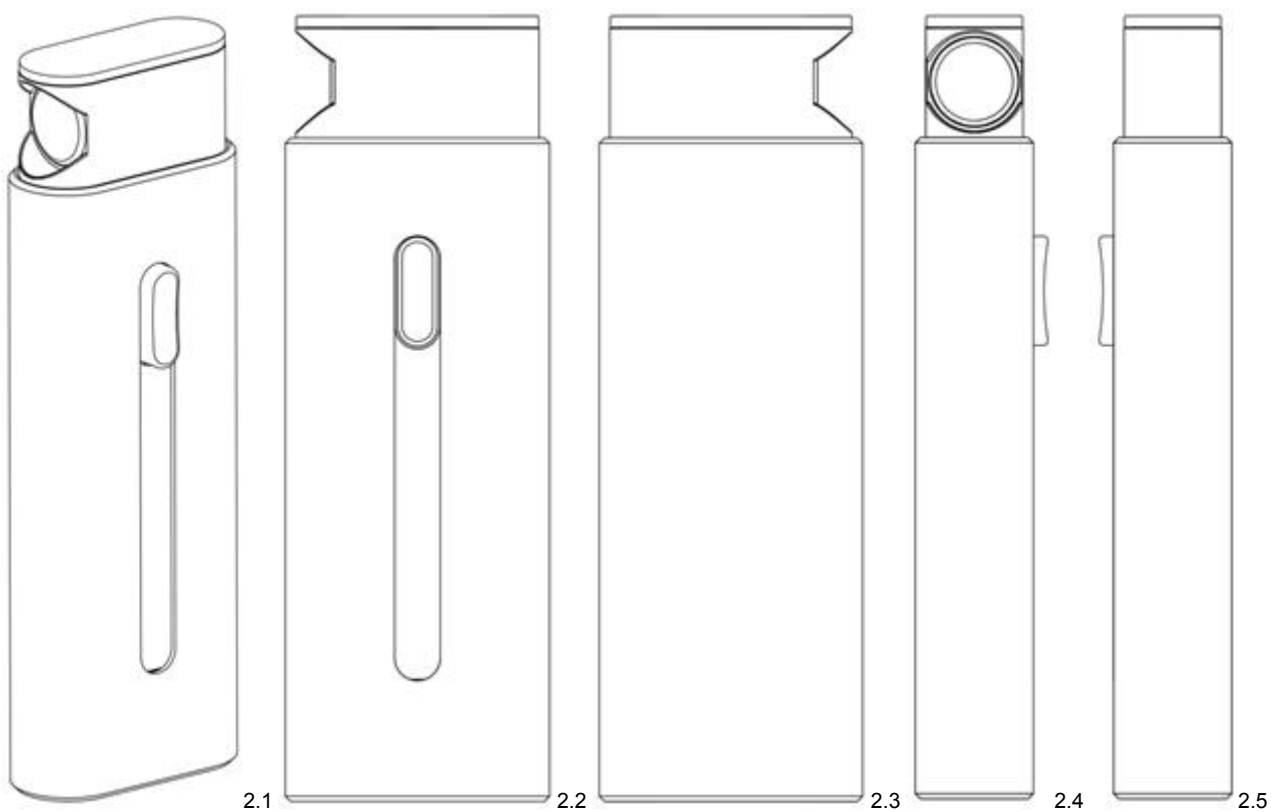



2.6



2.7

Design 3(54) **Produkt:**

Extinguisher for tobacco heat sticks and aerosol generators

(51) **Klasse:**

27-99

(72) **Designer:**

Florent Cuchet, Jaktvarvsplan 3, 11236 STOCKHOLM, Sverige (SE)

Kyungil Chung, 111 Silchester Park GLENAGEARY, CO. DUBLIN, Irland (IE)

Philip Nilsson, 10 Quinsborough Road, A98 NN92 BRAY, CO WICKLOW, Irland (IE)

(30) **Prioritet:**

2017.05.26, EM, 004020394, 1, 2, 3

(55) **Designavbildninger:**

3.1

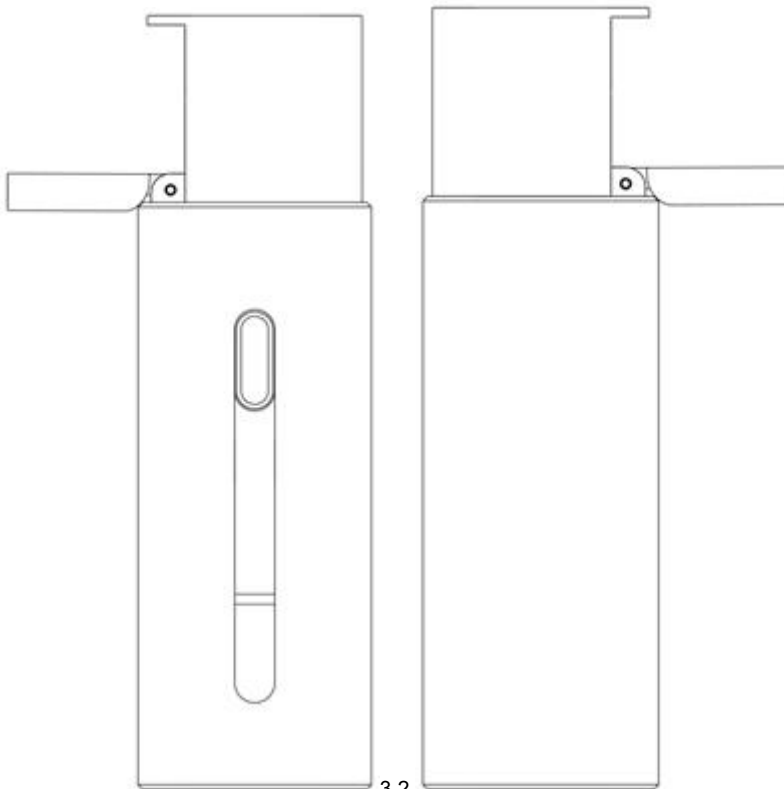

3.2



3.3

3.4



3.5



3.6



3.7

(11)	Reg.nr.:	DM/100032
(21)	Søkn.nr.:	20180367
(22)	Inngitt i WIPO:	2017.11.16
(15)	Registrert i WIPO:	2017.11.16
(24)	Løpedag:	2017.11.16
(43)	Allm. tilgj.:	2018.05.18
(15)	Besluttet gjeldende NO:	2018.06.29
(45)	Kunngjort NO:	2018.07.16
(18)	Reg. gjelder til:	2022.11.16
(73)	Innehaver:	Xtreme Lashes, LLC, 24127 West Hardy Road, US-TX77373 SPRING, USA

Design 1

(54)	Produkt:	Tweezers
(51)	Klasse:	28-03
(72)	Designer:	Joumana Mousselli, 24127 West Hardy Road, TX77373 SPRING, USA (US) Ayad Mousselli, 24127 West Hardy Road, TX77373 SPRING, USA (US) Noor Daoudi, 24127 West Hardy Road, TX77373 SPRING, USA (US)
(55)	Designavbildninger:	

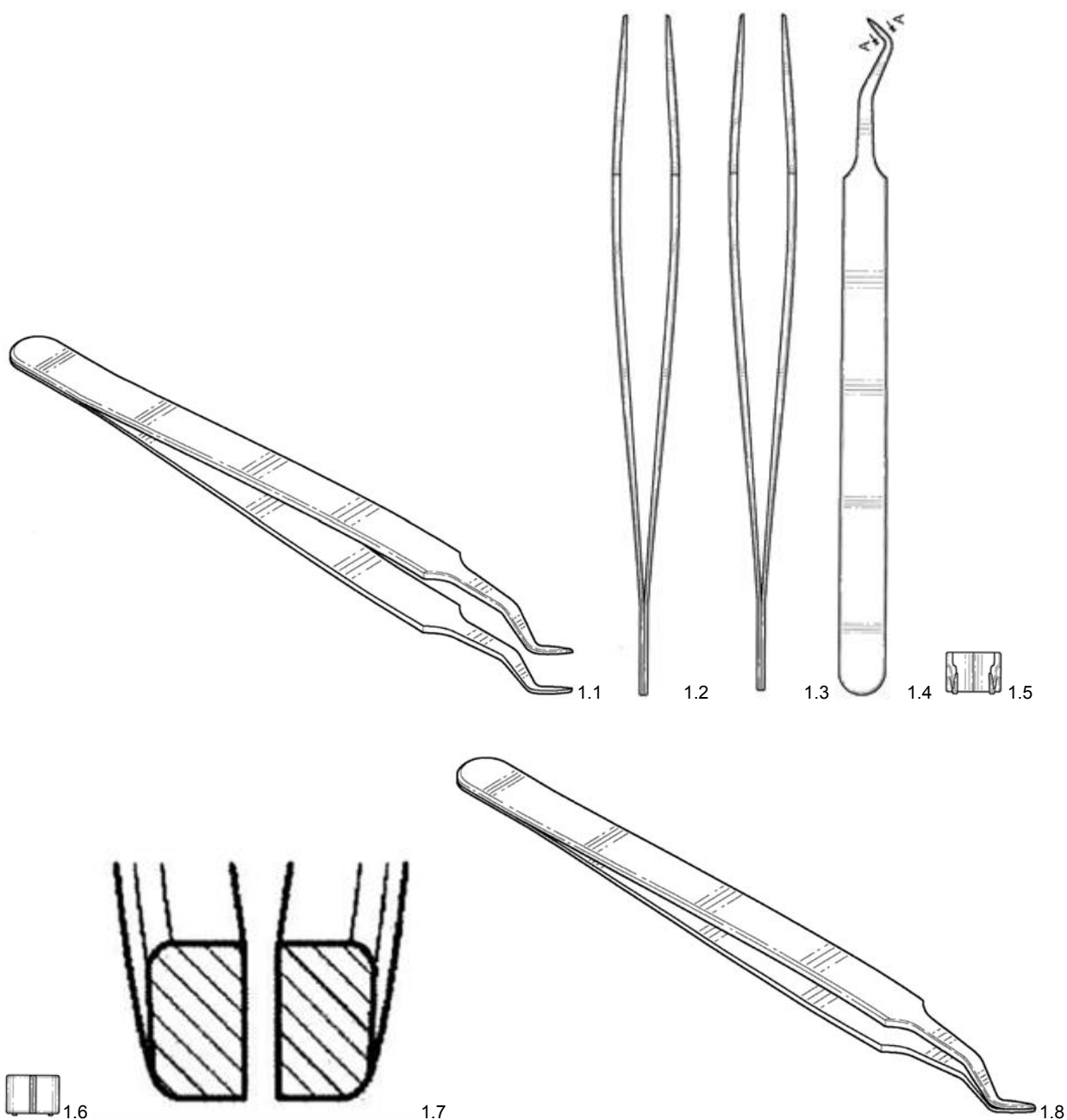

- (11) **Reg.nr.:** DM/100201
(21) **Søkn.nr.:** 20180364
(22) **Inngitt i WIPO:** 2017.11.06
(15) **Registrert i WIPO:** 2017.11.06
(24) **Løpedag:** 2017.11.06
(43) **Allm. tilgj.:** 2018.05.11
(15) **Besluttet gjeldende NO:** 2018.06.20
(45) **Kunngjort NO:** 2018.07.16
(18) **Reg. gjelder til:** 2022.11.06
(73) **Innehaver:** NOMENTA TECHNOLOGIES (GUANGZHOU) LTD., 5th Floor, Block A, Lianfeng Creative Park, No.2 Jisheng Road, Huangge Town, Nansha District, CN-511455 GUANGZHOU, GUANGDONG, Kina
(50) **Anmerkninger:** Registreringen gjelder samregistrering.

Design 1

- (54) **Produkt:** LED bluetooth speaker lamps
(51) **Klasse:** 26-05
(72) **Designer:** Christian Schjerbeck Jensen, 5th Floor, Block A, Lianfeng Creative Park, No.2 Jisheng Road, Huangge Town, Nansha District, 511455 GUANGZHOU, GUANGDONG, Kina (CN)
(30) **Prioritet:** 2017.05.05, CN, 201730162330.5, 1, 2, 3, 4
(55) **Designavbildninger:**



1.1



1.2

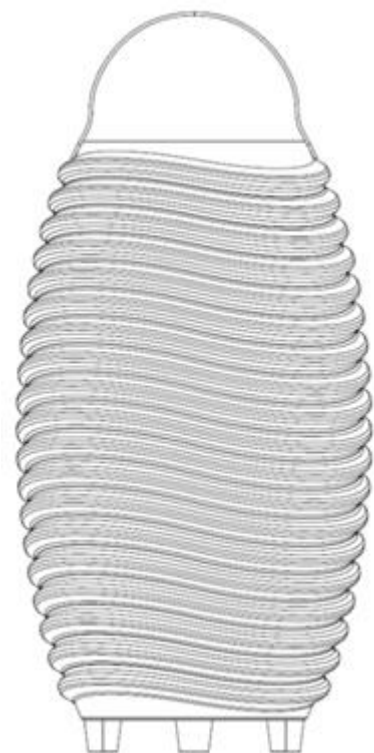

1.3



1.4

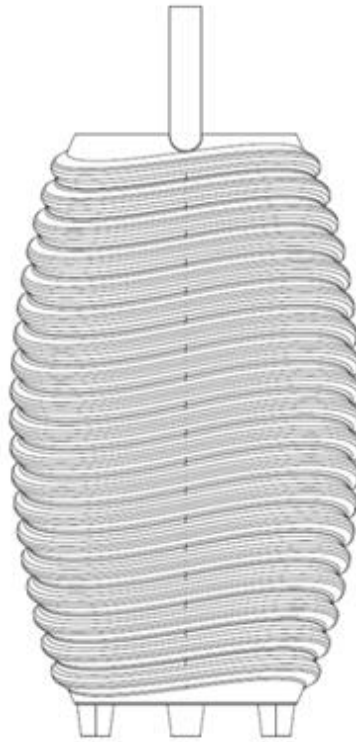

1.5

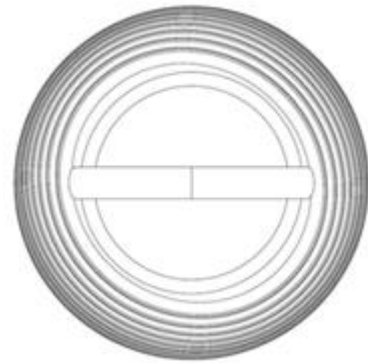

1.6

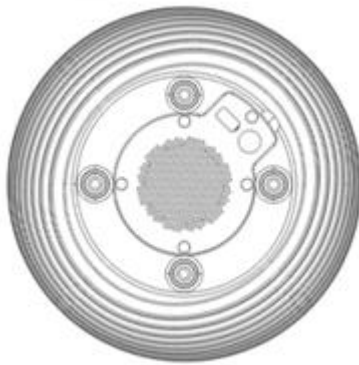

1.7

Design 2

- (54) **Produkt:** LED bluetooth speaker lamps
(51) **Klasse:** 26-05
(72) **Designer:** Christian Schjerbeck Jensen, 5th Floor, Block A, Lianfeng Creative Park, No.2 Jisheng Road, Huangge Town, Nansha District, 511455 GUANGZHOU, GUANGDONG, Kina (CN)
(30) **Prioritet:** 2017.05.05, CN, 201730162330.5, 1, 2, 3, 4
(55) **Designavbildninger:**

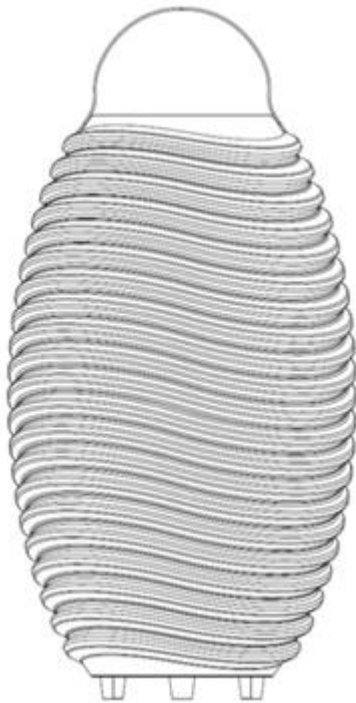

2.1



2.2

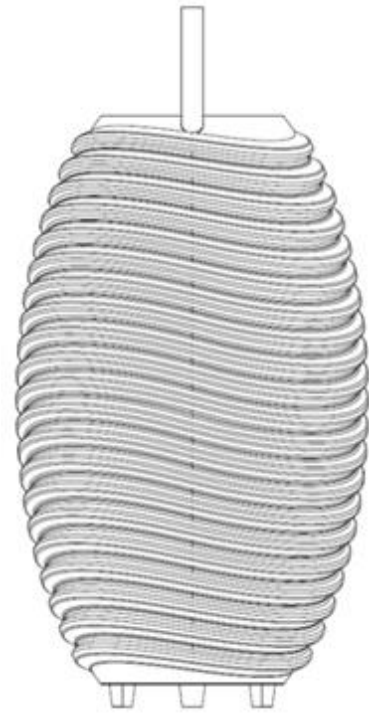

2.3



2.4

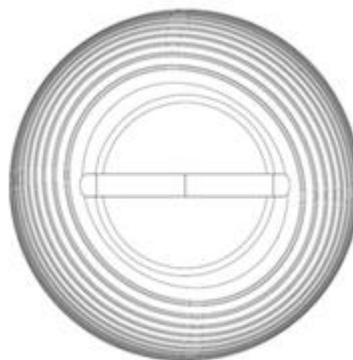

2.5

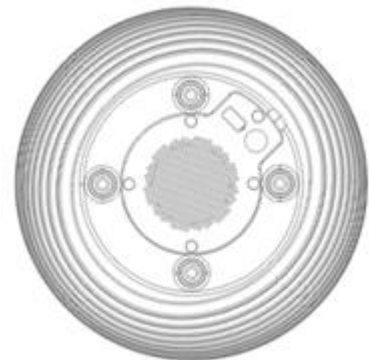

2.6



2.7

Design 3(54) **Produkt:** LED bluetooth speaker lamps(51) **Klasse:** 26-05(72) **Designer:** Christian Schjerbeck Jensen, 5th Floor, Block A, Lianfeng Creative Park, No.2 Jisheng Road, Huangge Town, Nansha District, 511455 GUANGZHOU, GUANGDONG, Kina (CN)(30) **Prioritet:** 2017.05.05, CN, 201730162330.5, 1, 2, 3, 4(55) **Designavbildninger:**

3.1

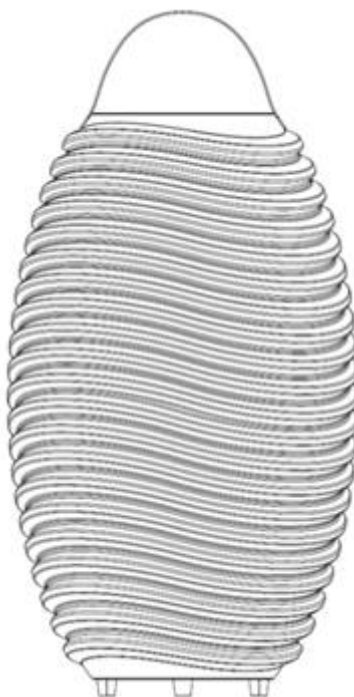

3.2

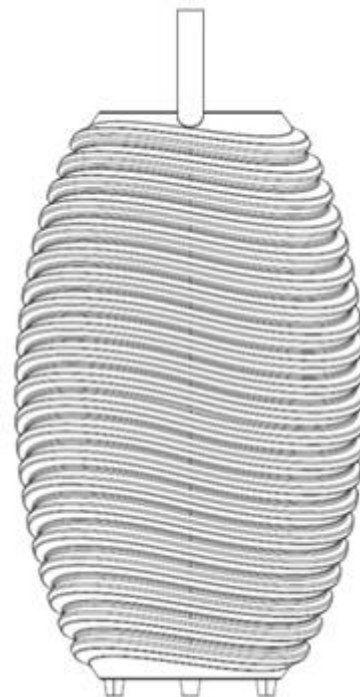

3.3



3.4

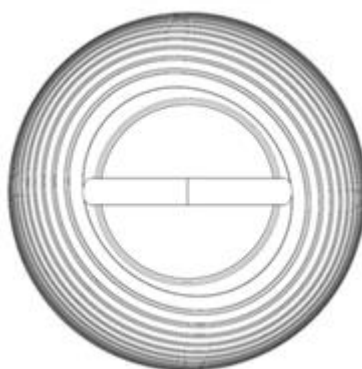

3.5

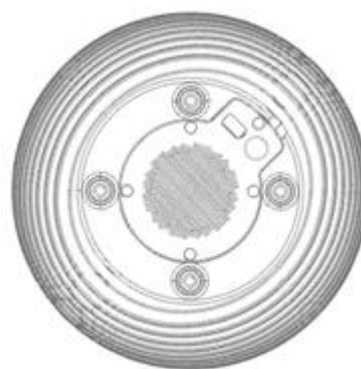

3.6



3.7

Design 4

- (54) **Produkt:** LED bluetooth speaker lamps
(51) **Klasse:** 26-05
(72) **Designer:** Christian Schjerbeck Jensen, 5th Floor, Block A, Lianfeng Creative Park, No.2 Jisheng Road, Huangge Town, Nansha District, 511455 GUANGZHOU, GUANGDONG, Kina (CN)
(30) **Prioritet:** 2017.05.05, CN, 201730162330.5, 1, 2, 3, 4
(55) **Designavbildninger:**

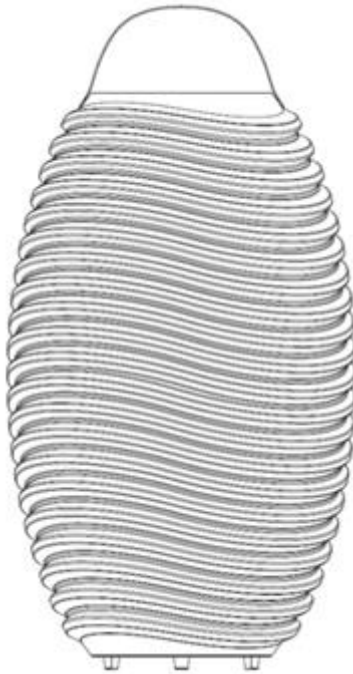

4.1

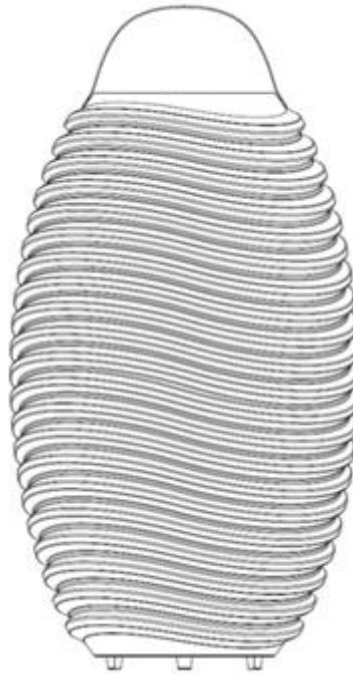

4.2



4.3



4.4

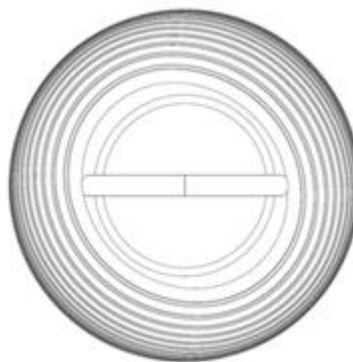

4.5

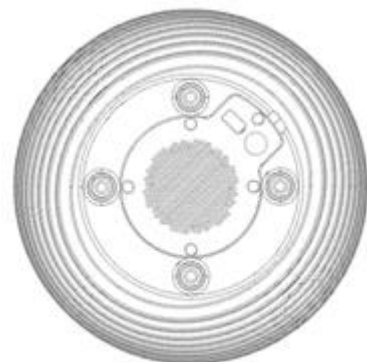

4.6



4.7

(11)	Reg.nr.:	DM/100243
(21)	Søkn.nr.:	20180366
(22)	Inngitt i WIPO:	2017.11.10
(15)	Registrert i WIPO:	2017.11.10
(24)	Løpedag:	2017.11.10
(43)	Allm. tilgj.:	2018.05.11
(15)	Besluttet gjeldende NO:	2018.06.25
(45)	Kunngjort NO:	2018.07.16
(18)	Reg. gjelder til:	2022.11.10
(73)	Innehaver:	NIKKO CO., LTD., 110-1, Tsuruno, JP-084-0924 KUSHIRO-SHI, HOKKAIDO, Japan

Design 1

(54)	Produkt:	Fish body position fixation plate for seafood processing machine
(51)	Klasse:	31-00
(72)	Designer:	Kazuo SATO, Nikko Co., Ltd. 110-1 Tsuruno, 084-0924 KUSHIRO-SHI, HOKKAIDO, Japan (JP)
(30)	Prioritet:	2017.05.16, JP, 2017-11911, 1
(55)	Designavbildninger:	

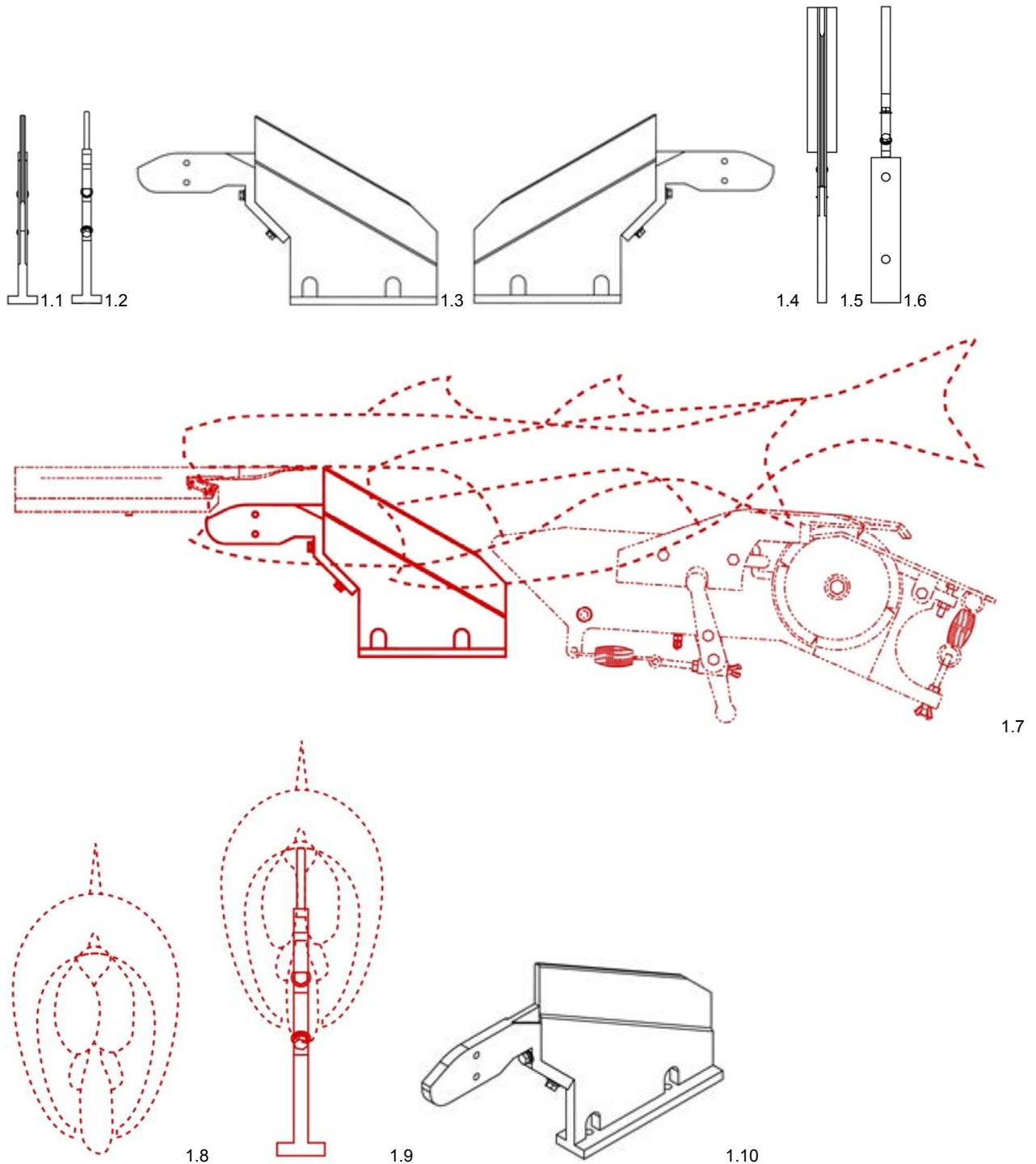

(11) Reg.nr.:	DM/100267
(21) Søkn.nr.:	20180326
(22) Inngitt i WIPO:	2018.03.13
(15) Registrert i WIPO:	2018.03.13
(24) Løpedag:	2018.03.13
(43) Allm. tilgj.:	2018.03.30
(15) Besluttet gjeldende NO:	2018.06.25
(45) Kunngjort NO:	2018.07.16
(18) Reg. gjelder til:	2023.03.13
(73) Innehaver:	DESIGNERS COMPANY APS C/O MENUSPACE APS, Hamborg Plads 2, DK-2150 NORDHAVN, Danmark
(50) Anmerkninger:	Registreringen gjelder samregistrering.

Design 1

(54) Produkt:	Chair [seat]
(51) Klasse:	06-01 06-03 06-04
(72) Designer:	Norm Architects, Snaregade 14, 1205 COPENHAGEN, Tyskland (DE)
(55) Designavbildninger:	

**Design 2**

(54) Produkt:	Table
(51) Klasse:	06-01 06-03 06-04
(72) Designer:	Note Design Studio, Nytorgsgatan 23, 11640 STOCKHOLM, Sverige (SE) Norm Architects, Snaregade 14, 1205 COPENHAGEN, Tyskland (DE)
(55) Designavbildninger:	



Design 3

- (54) **Produkt:** Shelving
(51) **Klasse:** 06-01
06-03
06-04
(72) **Designer:** Kaschkasch, Hoeningeweg 174, 50969 COLOGNE, Tyskland (DE)
(55) **Designavbildninger:**

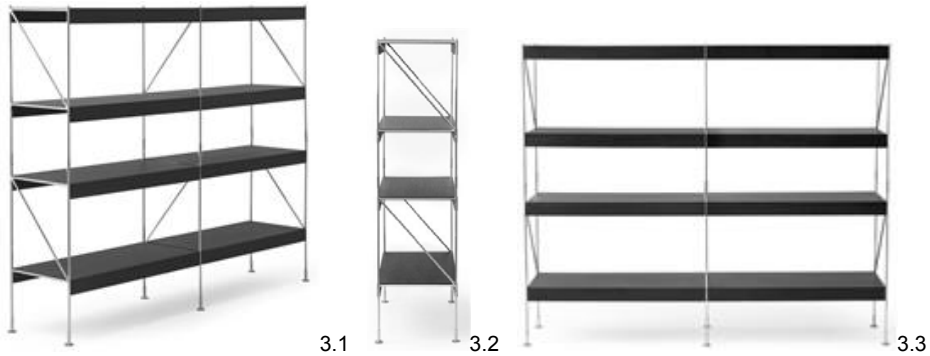
**Design 4**

- (54) **Produkt:** Chair [seat]
(51) **Klasse:** 06-01
06-03
06-04
(72) **Designer:** Norm Architects, Snaregade 14, 1205 COPENHAGEN, Tyskland (DE)
(55) **Designavbildninger:**



(11) Reg.nr.:	DM/100268
(21) Søkn.nr.:	20180327
(22) Inngitt i WIPO:	2018.03.13
(15) Registrert i WIPO:	2018.03.13
(24) Løpedag:	2018.03.13
(43) Allm. tilgj.:	2018.03.30
(15) Besluttet gjeldende NO:	2018.06.25
(45) Kunngjort NO:	2018.07.16
(18) Reg. gjelder til:	2023.03.13
(73) Innehaver:	DESIGNERS COMPANY APS C/O MENUSPACE APS, Hamborg Plads 2, DK-2150 NORDHAVN, Danmark
(50) Anmerkninger:	Registreringen gjelder samregistrering.

Design 1

(54) Produkt:	Flower vases
(51) Klasse:	11-02
(72) Designer:	Theresa Arns, Frederiksgade 1, 4.th, 1265 COPENHAGEN, Danmark (DK)
(55) Designavbildninger:	

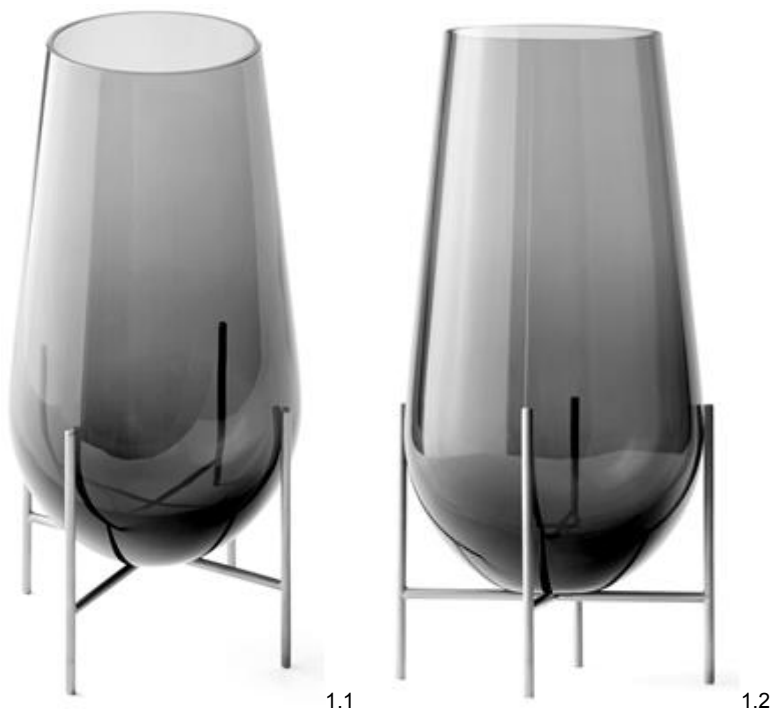
**Design 2**

(54) Produkt:	Flower vases
(51) Klasse:	11-02
(72) Designer:	Note Design Studio, Nytorgsgatan 23, 11640 STOCKHOLM, Sverige (SE)
(55) Designavbildninger:	

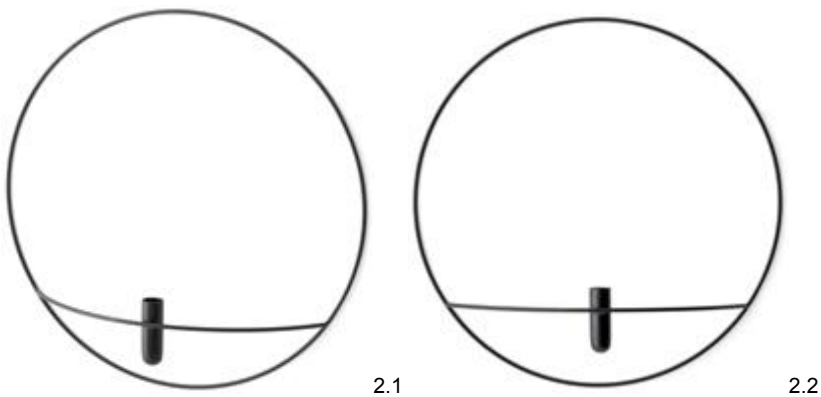

(11)	Reg.nr.:	DM/100289
(21)	Søkn.nr.:	20180334
(22)	Inngitt i WIPO:	2018.03.12
(15)	Registrert i WIPO:	2018.03.12
(24)	Løpedag:	2018.03.12
(43)	Allm. tilgj.:	2018.04.06
(15)	Besluttet gjeldende NO:	2018.06.22
(45)	Kunngjort NO:	2018.07.16
(18)	Reg. gjelder til:	2023.03.12
(73)	Innehaver:	FRANZ NEUHOFER JUN, Haslau 56, AT-4893 ZELL AM MOOS, Østerrike
(50)	Anmerkninger:	Registreringen gjelder samregistrering.

Design 1

(54)	Produkt:	Screws
(51)	Klasse:	08-08
(72)	Designer:	Franz Neuhofer, Haslau 56, 4893 ZELL AM MOOS, Østerrike (AT)
(30)	Prioritet:	2017.09.15, EM, 004354629, 1, 2, 3, 4, 5, 6, 7, 8, 9
(55)	Designavbildninger:	

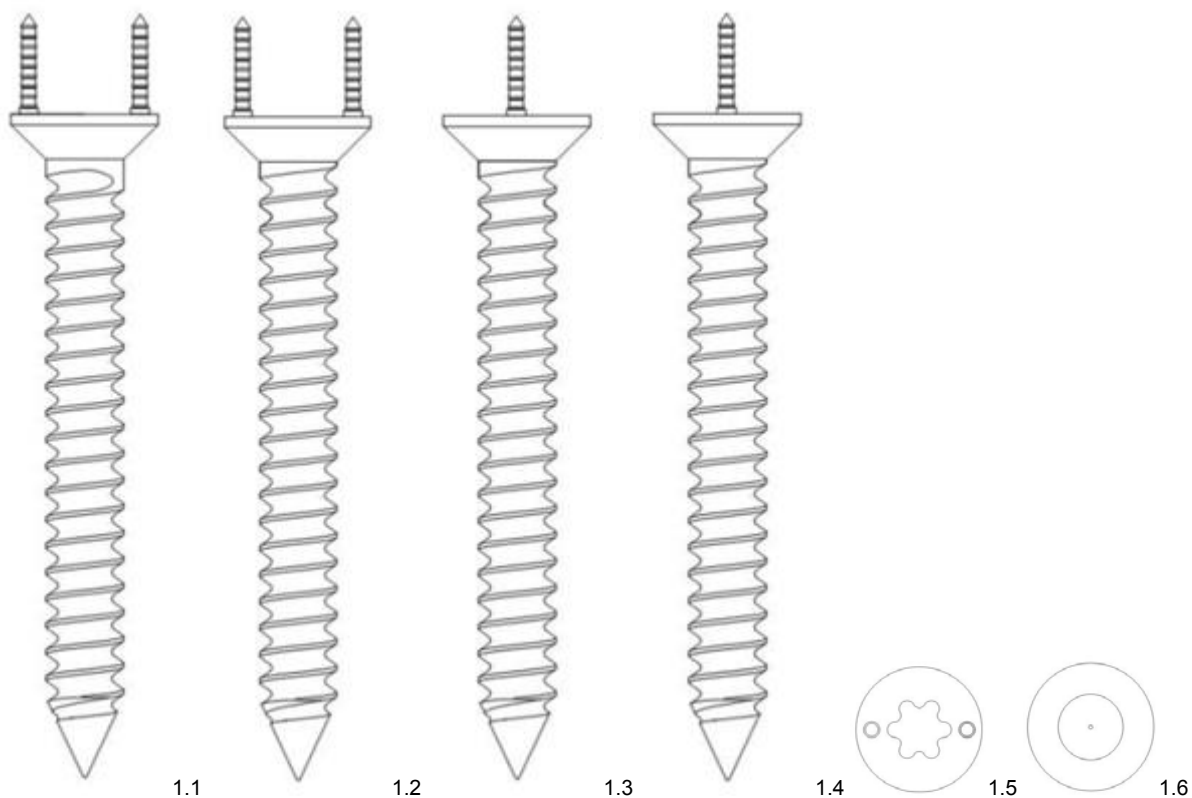

Design 2

- (54) **Produkt:** Screws
(51) **Klasse:** 08-08
(72) **Designer:** Franz Neuhofer, Haslau 56, 4893 ZELL AM MOOS, Østerrike (AT)
(30) **Prioritet:** 2017.09.15, EM, 004354629, 1, 2, 3, 4, 5, 6, 7, 8, 9
(55) **Designavbildninger:**

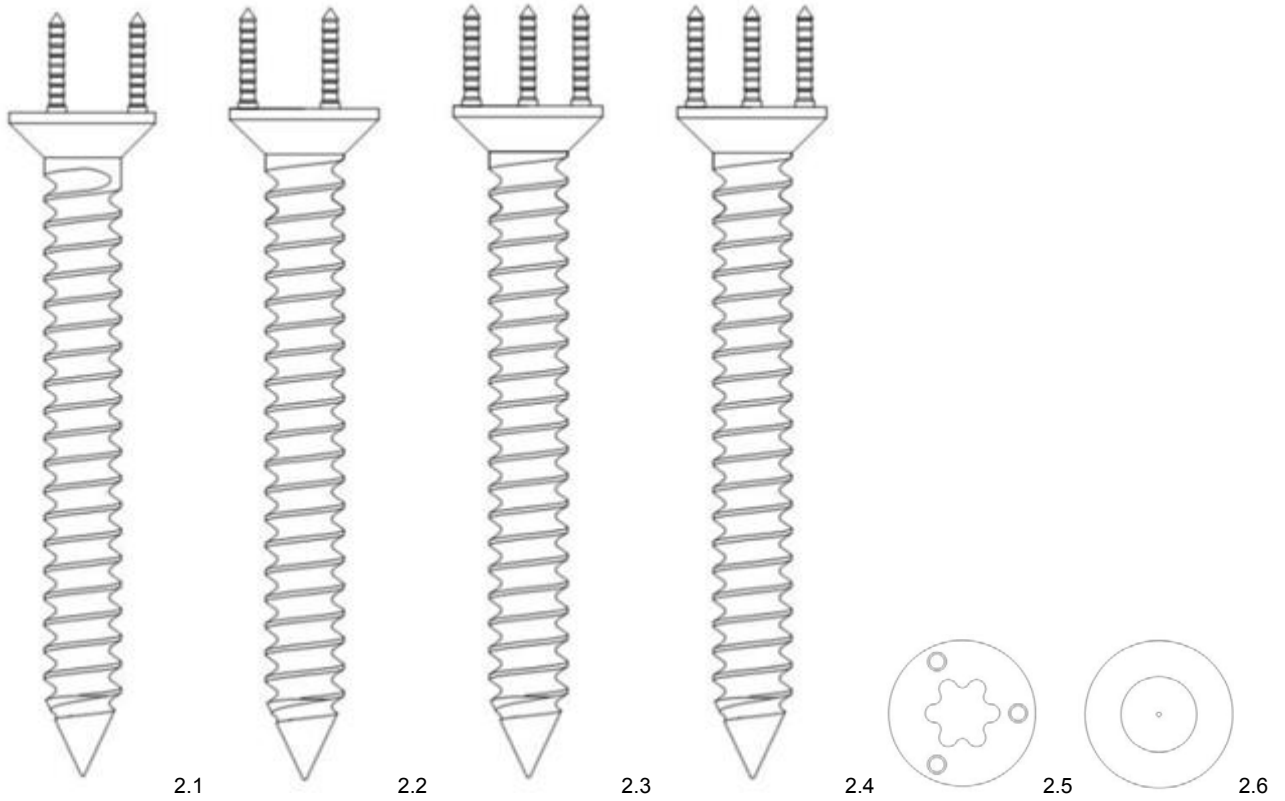

Design 3

- (54) **Produkt:** Screws
(51) **Klasse:** 08-08
(72) **Designer:** Franz Neuhofer, Haslau 56, 4893 ZELL AM MOOS, Østerrike (AT)
(30) **Prioritet:** 2017.09.15, EM, 004354629, 1, 2, 3, 4, 5, 6, 7, 8, 9
(55) **Designavbildninger:**



3.1



3.2



3.3



3.4

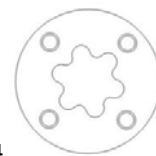

3.5

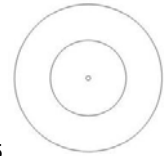

3.6

Design 4

- (54) **Produkt:** Screws
(51) **Klasse:** 08-08
(72) **Designer:** Franz Neuhofer, Haslau 56, 4893 ZELL AM MOOS, Østerrike (AT)
(30) **Prioritet:** 2017.09.15, EM, 004354629, 1, 2, 3, 4, 5, 6, 7, 8, 9
(55) **Designavbildninger:**



4.1



4.2



4.3



4.4



4.5

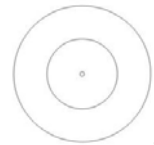

4.6

Design 5

- (54) **Produkt:** Screws
(51) **Klasse:** 08-08
(72) **Designer:** Franz Neuhofer, Haslau 56, 4893 ZELL AM MOOS, Østerrike (AT)
(30) **Prioritet:** 2017.09.15, EM, 004354629, 1, 2, 3, 4, 5, 6, 7, 8, 9
(55) **Designavbildninger:**



5.1



5.2



5.3



5.4

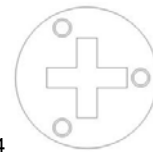

5.5

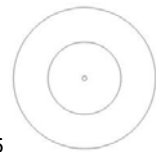

5.6

Design 6

- (54) **Produkt:** Screws
(51) **Klasse:** 08-08
(72) **Designer:** Franz Neuhofer, Haslau 56, 4893 ZELL AM MOOS, Østerrike (AT)
(30) **Prioritet:** 2017.09.15, EM, 004354629, 1, 2, 3, 4, 5, 6, 7, 8, 9
(55) **Designavbildninger:**



6.1



6.2



6.3



6.4

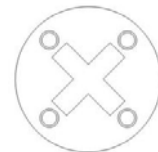

6.5

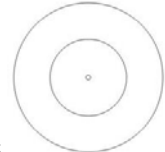

6.6

Design 7

(54) **Produkt:** Screws
(51) **Klasse:** 08-08
(72) **Designer:** Franz Neuhofer, Haslau 56, 4893 ZELL AM MOOS, Østerrike (AT)
(30) **Prioritet:** 2017.09.15, EM, 004354629, 1, 2, 3, 4, 5, 6, 7, 8, 9
(55) **Designavbildninger:**

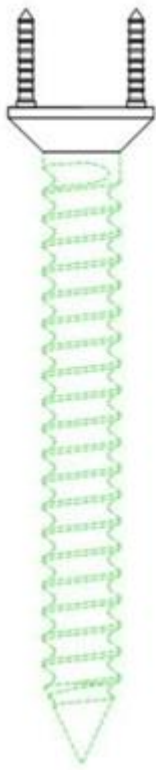

7.1



7.2



7.3



7.4

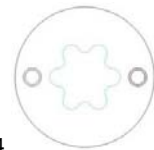

7.5



7.6

Design 8

- (54) **Produkt:** Screws
(51) **Klasse:** 08-08
(72) **Designer:** Franz Neuhofer, Haslau 56, 4893 ZELL AM MOOS, Østerrike (AT)
(30) **Prioritet:** 2017.09.15, EM, 004354629, 1, 2, 3, 4, 5, 6, 7, 8, 9
(55) **Designavbildninger:**



8.1



8.2



8.3



8.4



8.5

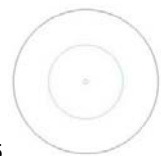

8.6

Design 9

- (54) **Produkt:** Screws
(51) **Klasse:** 08-08
(72) **Designer:** Franz Neuhofer, Haslau 56, 4893 ZELL AM MOOS, Østerrike (AT)
(30) **Prioritet:** 2017.09.15, EM, 004354629, 1, 2, 3, 4, 5, 6, 7, 8, 9
(55) **Designavbildninger:**

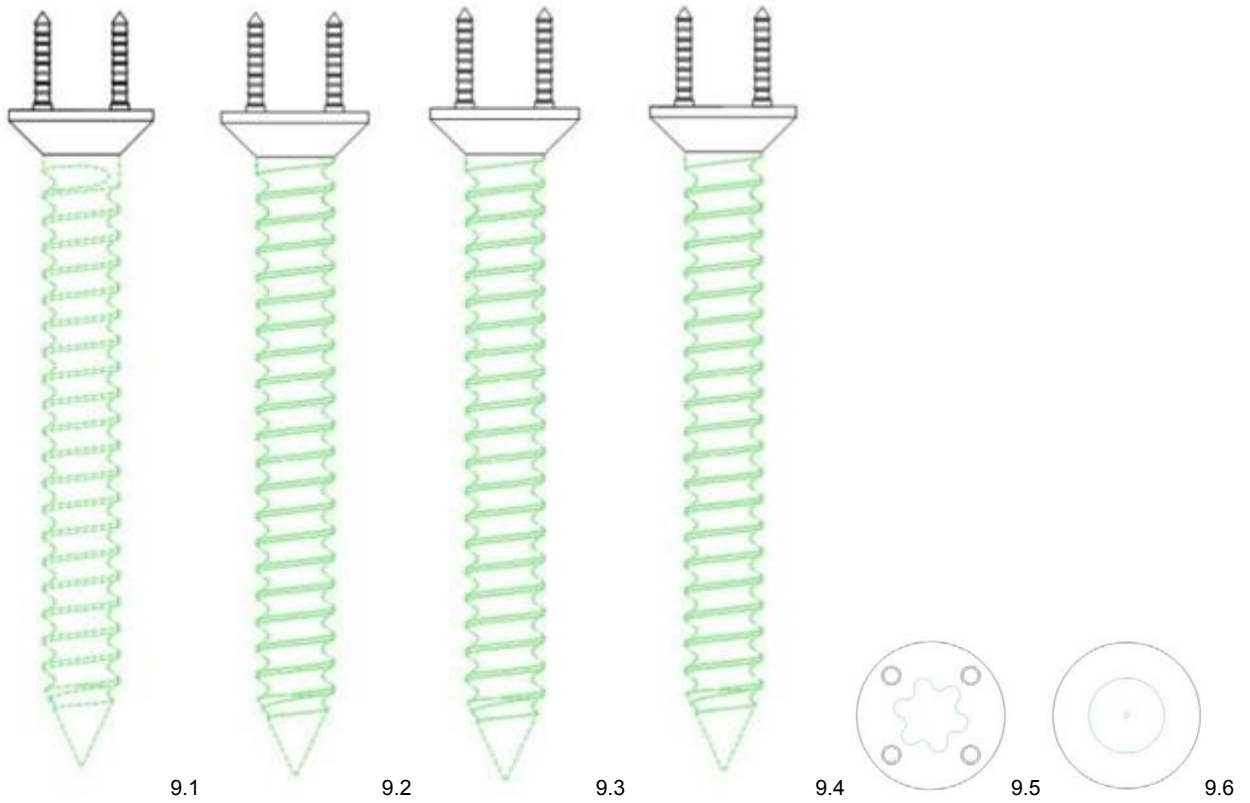

(11)	Reg.nr.:	DM/100315
(21)	Søkn.nr.:	20180337
(22)	Inngitt i WIPO:	2018.03.13
(15)	Registrert i WIPO:	2018.03.13
(24)	Løpedag:	2018.03.13
(43)	Allm. tilgj.:	2018.04.06
(15)	Besluttet gjeldende NO:	2018.06.22
(45)	Kunngjort NO:	2018.07.16
(18)	Reg. gjelder til:	2023.03.13
(73)	Innehaver:	DESIGNERS COMPANY APS C/O MENUSPACE APS, Hamborg Plads 2, DK-2150 NORDHAVN, Danmark

Design 1

(54)	Produkt:	Bowl
(51)	Klasse:	07-01
(72)	Designer:	Theresa Arns, Frederiksgade 1, 4.th, 1265 COPENHAGEN, Danmark (DK)
(55)	Designavbildninger:	



1.1

(11)	Reg.nr.:	DM/100707
(21)	Søkn.nr.:	20180427
(22)	Inngitt i WIPO:	2018.04.13
(15)	Registrert i WIPO:	2018.04.13
(24)	Løpedag:	2018.04.13
(43)	Allm. tilgj.:	2018.05.04
(15)	Besluttet gjeldende NO:	2018.06.29
(45)	Kunngjort NO:	2018.07.16
(18)	Reg. gjelder til:	2023.04.13
(73)	Innehaver:	Deichmann SE, Deichmannweg 9, DE-45359 ESSEN, Tyskland
(50)	Anmerkninger:	Registreringen gjelder samregistrering.

Design 1

(54)	Produkt:	Footwear soles
(51)	Klasse:	02-04
(72)	Designer:	Roberto Sabatino, Via G. Marconi, 257/1, 51018 PIEVE A NIEVOLE, Italia (IT)
(50)	Anmerkning:	Designet er i farger.
(55)	Designavbildninger:	

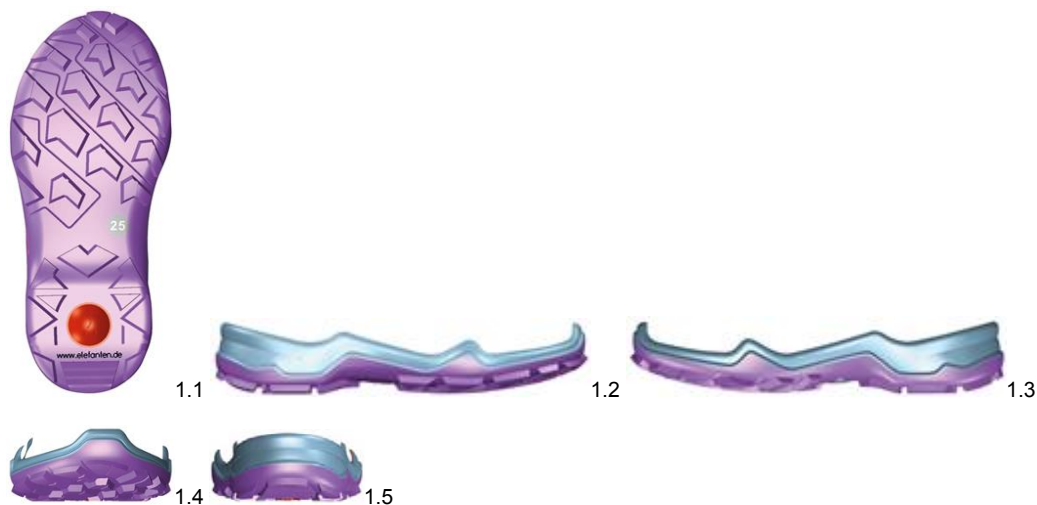
**Design 2**

(54)	Produkt:	Footwear soles
(51)	Klasse:	02-04
(72)	Designer:	Roberto Sabatino, Via G. Marconi, 257/1, 51018 PIEVE A NIEVOLE, Italia (IT)
(50)	Anmerkning:	Designet er i farger.
(55)	Designavbildninger:	

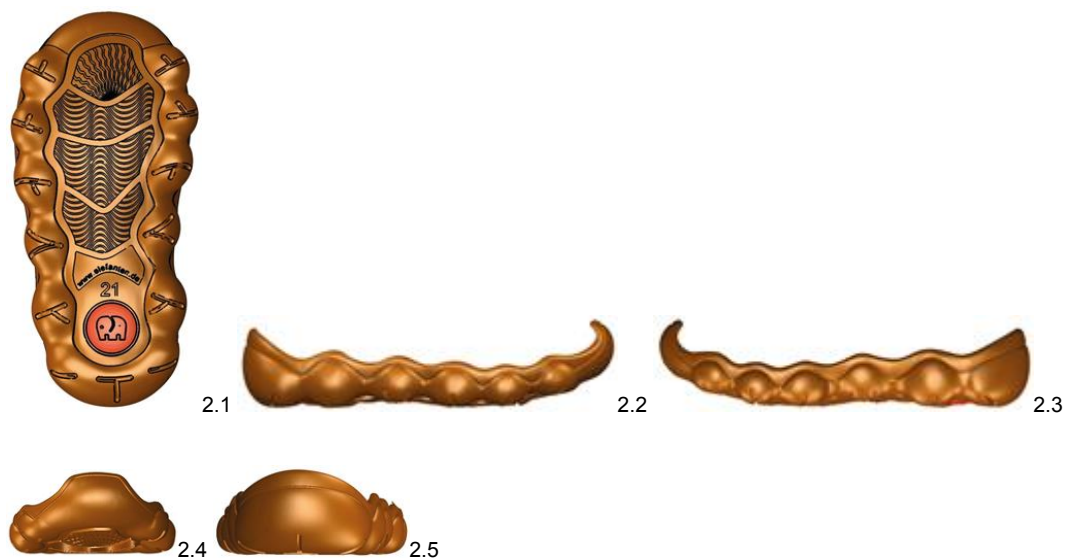

Design 3

- (54) **Produkt:** Footwear soles
(51) **Klasse:** 02-04
(72) **Designer:** Roberto Sabatino, Via G. Marconi, 257/1, 51018 PIEVE A NIEVOLE, Italia (IT)
(50) **Anmerkning:** Designet er i farger.
(55) **Designavbildninger:**

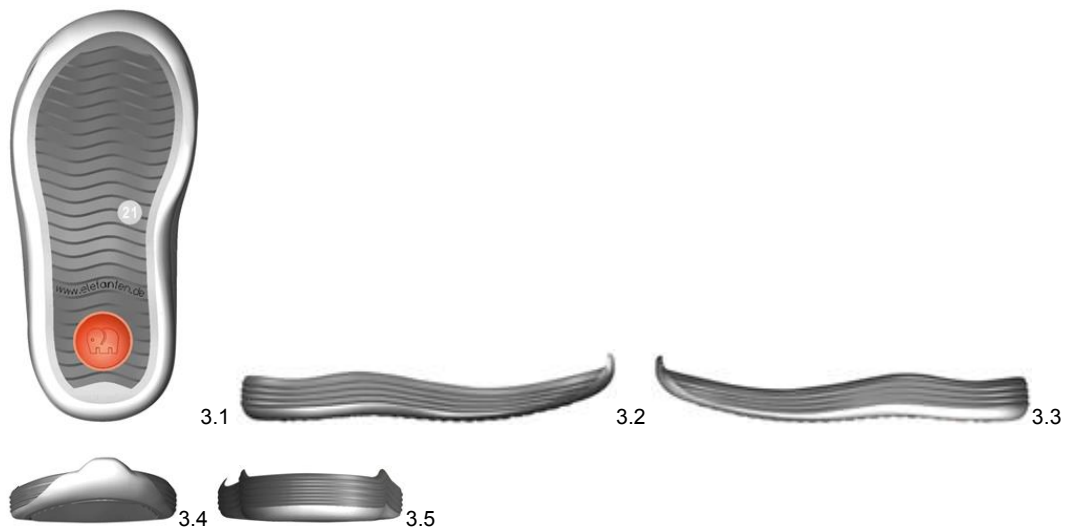
**Design 4**

- (54) **Produkt:** Footwear soles
(51) **Klasse:** 02-04
(72) **Designer:** Roberto Sabatino, Via G. Marconi, 257/1, 51018 PIEVE A NIEVOLE, Italia (IT)
(50) **Anmerkning:** Designet er i farger.
(55) **Designavbildninger:**

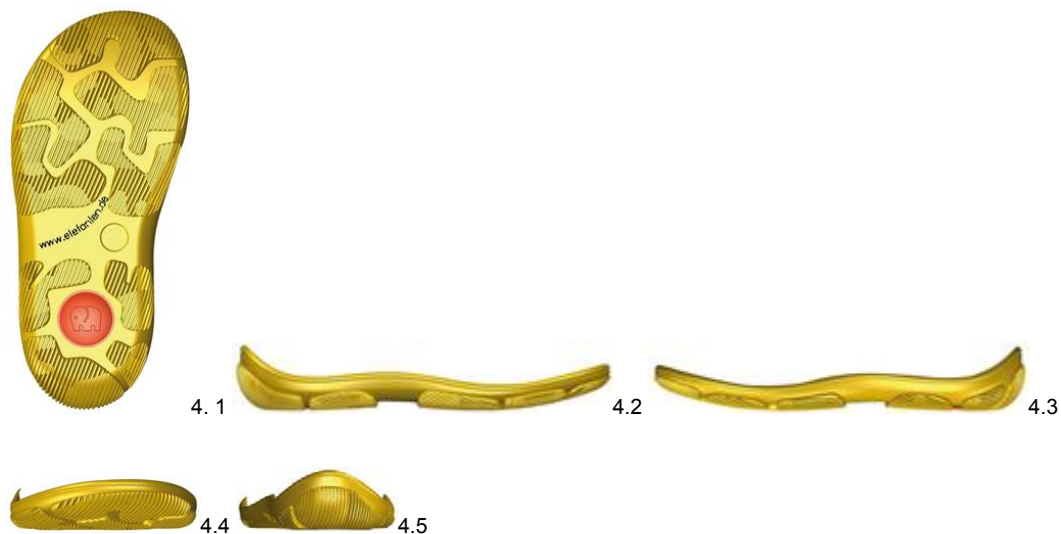

Design 5

- (54) **Produkt:** Footwear soles
(51) **Klasse:** 02-04
(72) **Designer:** Roberto Sabatino, Via G. Marconi, 257/1, 51018 PIEVE A NIEVOLE, Italia (IT)
(50) **Anmerkning:** Designet er i farger.
(55) **Designavbildninger:**

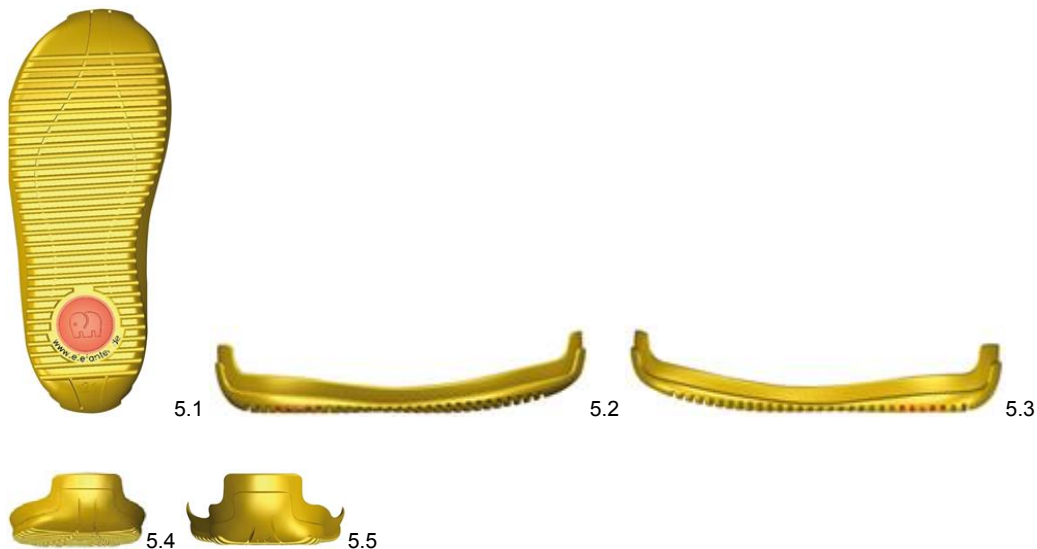
**Design 6**

- (54) **Produkt:** Footwear soles
(51) **Klasse:** 02-04
(72) **Designer:** Roberto Sabatino, Via G. Marconi, 257/1, 51018 PIEVE A NIEVOLE, Italia (IT)
(50) **Anmerkning:** Designet er i farger.
(55) **Designavbildninger:**

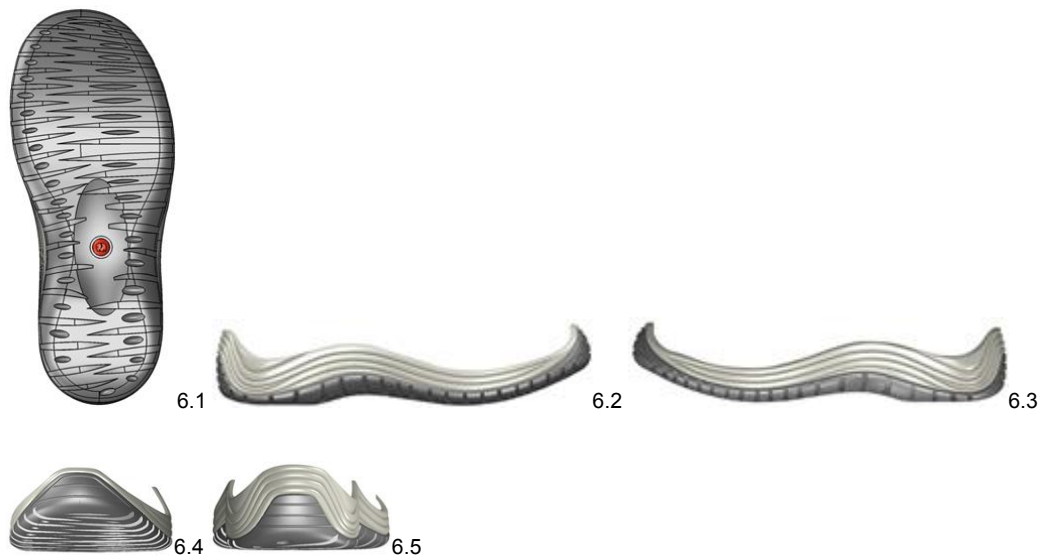

Design 7

- (54) **Produkt:** Footwear soles
(51) **Klasse:** 02-04
(72) **Designer:** Roberto Sabatino, Via G. Marconi, 257/1, 51018 PIEVE A NIEVOLE, Italia (IT)
(50) **Anmerkning:** Designet er i farger.
(55) **Designavbildninger:**

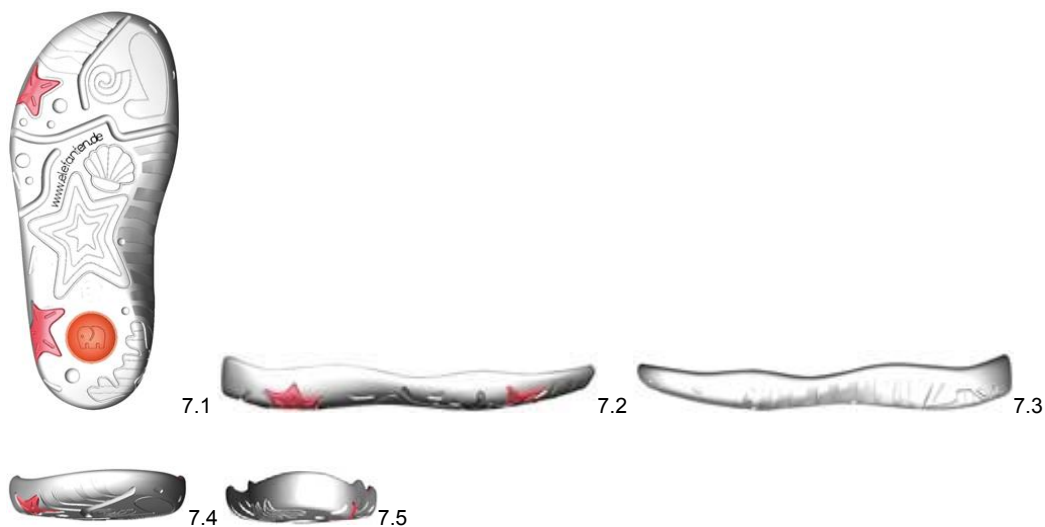
**Design 8**

- (54) **Produkt:** Footwear soles
(51) **Klasse:** 02-04
(72) **Designer:** Roberto Sabatino, Via G. Marconi, 257/1, 51018 PIEVE A NIEVOLE, Italia (IT)
(50) **Anmerkning:** Designet er i farger.
(55) **Designavbildninger:**

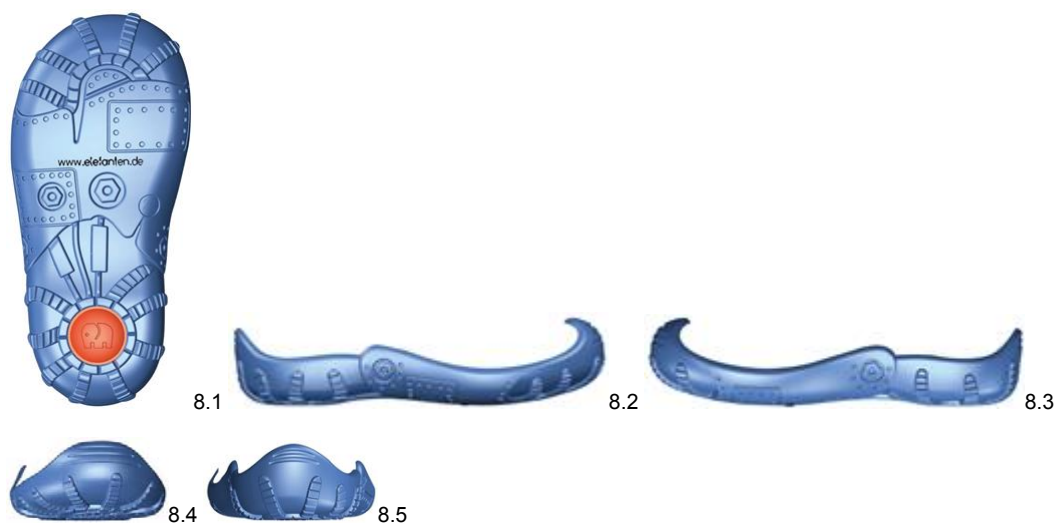

(11) Reg.nr.:	DM/100796
(21) Søkn.nr.:	20180433
(22) Inngitt i WIPO:	2018.02.21
(15) Registrert i WIPO:	2018.02.21
(24) Løpedag:	2018.02.21
(43) Allm. tilgj.:	2018.05.04
(15) Besluttet gjeldende NO:	2018.06.18
(45) Kunngjort NO:	2018.07.16
(18) Reg. gjelder til:	2023.02.21
(73) Innehaver:	Ian Kirk, The Birches Dalmuinzie Road, GB-AB159EB BIELDSIDE, Storbritannia Nathan Kirk, 40 Hutcheon Low Place, GB-AB219WL ABERDEEN, Storbritannia
(50) Anmerkninger:	Registreringen gjelder samregistrering.

Design 1

(54) Produkt:	Drilling tools
(51) Klasse:	08-01
(72) Designer:	Ian Kirk, The Birches Dalmuinzie Road, AB159EB BIELDSIDE, Storbritannia (GB) Nathan Kirk, 40 Hutcheon Low Place, AB219WL ABERDEEN, Storbritannia (GB)
(30) Prioritet:	2017.08.22, EM, 004158376, 1, 2, 3, 4, 5, 6, 7, 8, 9, 10
(55) Designavbildninger:	

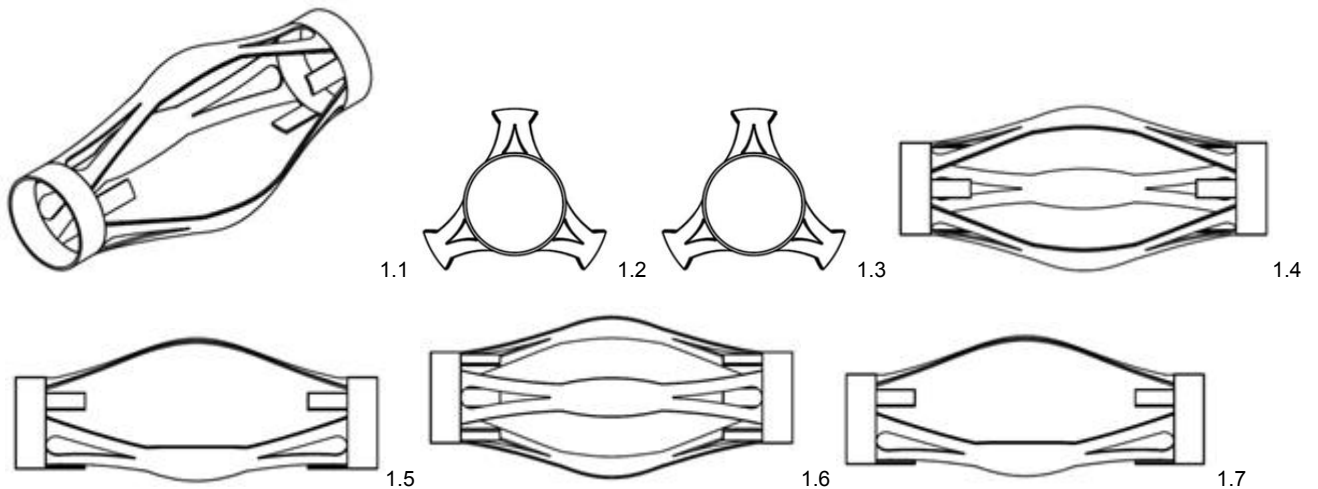
**Design 2**

(54) Produkt:	Drilling tools
(51) Klasse:	08-01
(72) Designer:	Ian Kirk, The Birches Dalmuinzie Road, AB159EB BIELDSIDE, Storbritannia (GB) Nathan Kirk, 40 Hutcheon Low Place, AB219WL ABERDEEN, Storbritannia (GB)
(30) Prioritet:	2017.08.22, EM, 004158376, 1, 2, 3, 4, 5, 6, 7, 8, 9, 10
(55) Designavbildninger:	

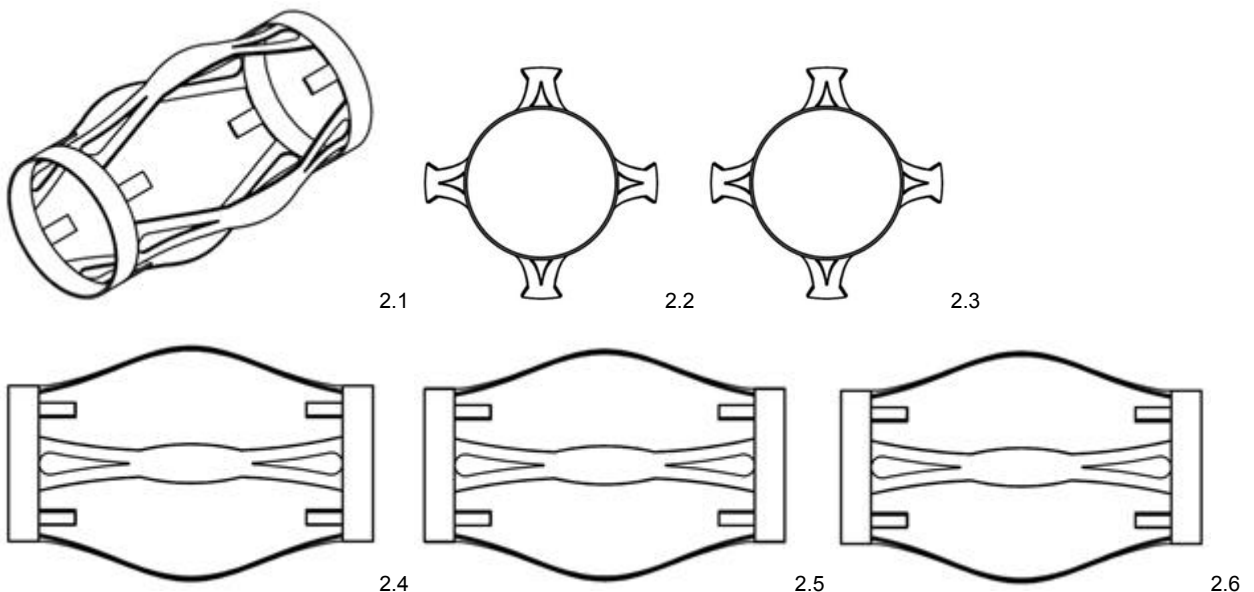

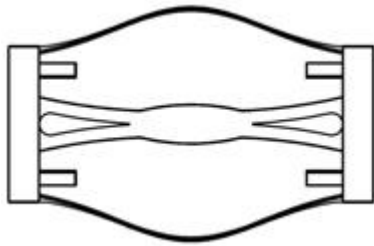

2.7

Design 3

- (54) **Produkt:** Drilling tools
 (51) **Klasse:** 08-01
 (72) **Designer:** Ian Kirk, The Birches Dalmuinzie Road, AB159EB BIELDSIDE, Storbritannia (GB)
 Nathan Kirk, 40 Hutcheon Low Place, AB219WL ABERDEEN, Storbritannia (GB)
 (30) **Prioritet:** 2017.08.22, EM, 004158376, 1, 2, 3, 4, 5, 6, 7, 8, 9, 10
 (55) **Designavbildninger:**

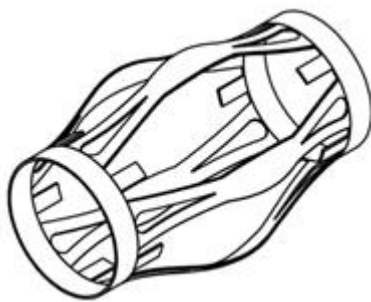

3.1

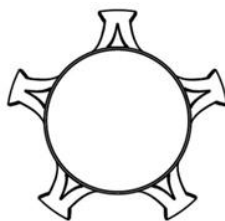

3.2

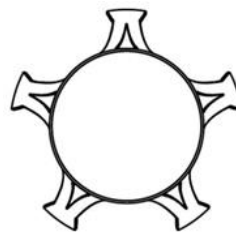

3.3

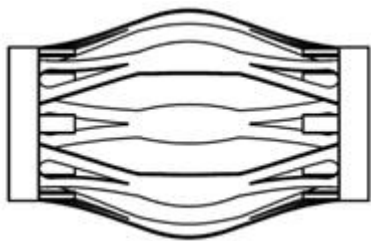

3.4

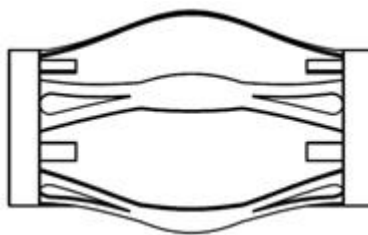

3.5

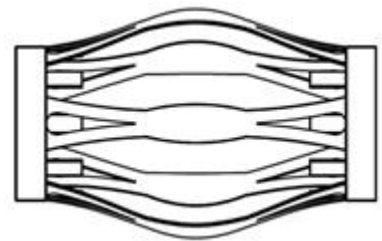

3.6

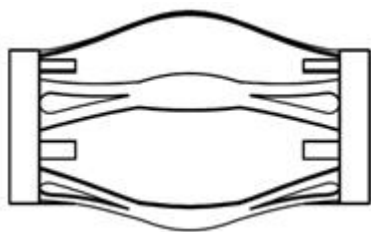

3.7

Design 4

- (54) **Produkt:** Drilling tools
 (51) **Klasse:** 08-01
 (72) **Designer:** Ian Kirk, The Birches Dalmuinzie Road, AB159EB BIELDSIDE, Storbritannia (GB)
 Nathan Kirk, 40 Hutcheon Low Place, AB219WL ABERDEEN, Storbritannia (GB)
 (30) **Prioritet:** 2017.08.22, EM, 004158376, 1, 2, 3, 4, 5, 6, 7, 8, 9, 10
 (55) **Designavbildninger:**

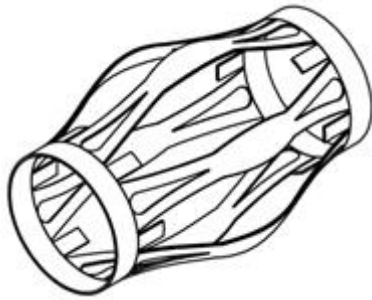

4.1

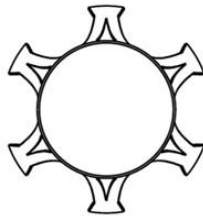

4.2

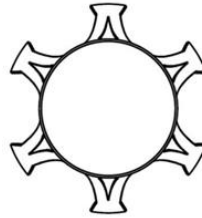

4.3

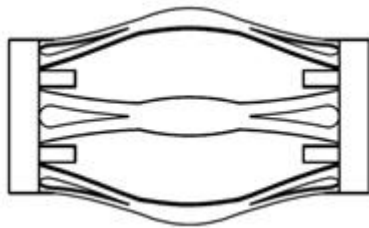

4.4

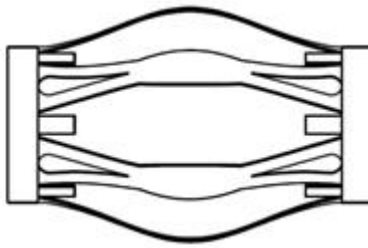

4.5

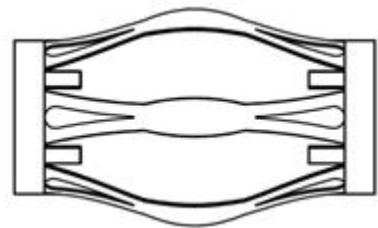

4.6

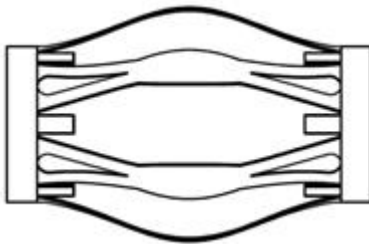

4.7

Design 5

- (54) **Produkt:** Drilling tools
 (51) **Klasse:** 08-01
 (72) **Designer:** Ian Kirk, The Birches Dalmuinzie Road, AB159EB BIELDSIDE, Storbritannia (GB)
 Nathan Kirk, 40 Hutcheon Low Place, AB219WL ABERDEEN, Storbritannia (GB)
 (30) **Prioritet:** 2017.08.22, EM, 004158376, 1, 2, 3, 4, 5, 6, 7, 8, 9, 10
 (55) **Designavbildninger:**

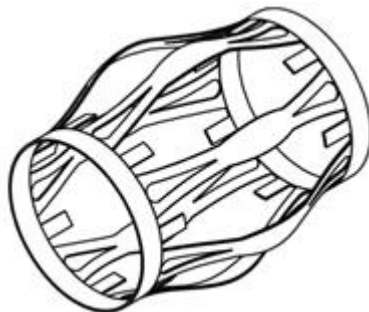

5.1

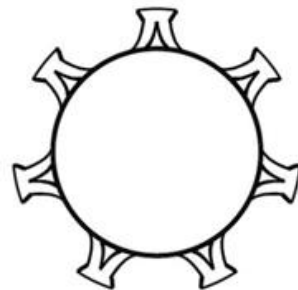

5.2

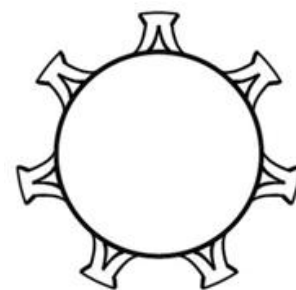

5.3

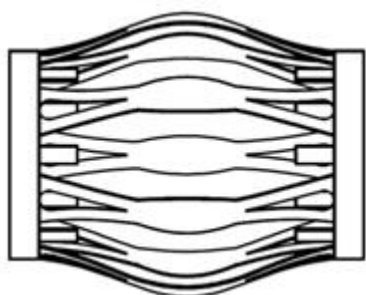

5.4

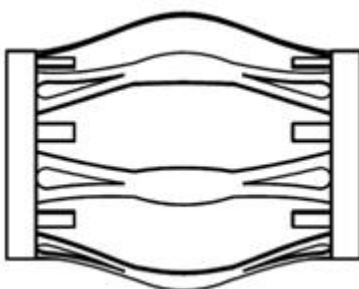

5.5

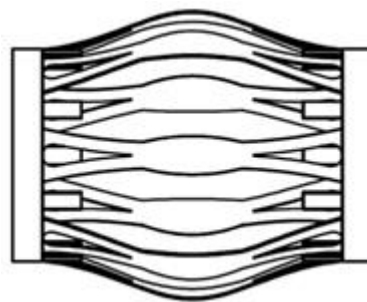

5.6

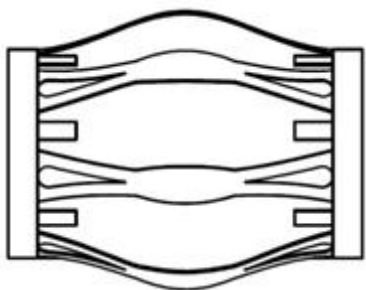

5.7

Design 6

- (54) **Produkt:** Drilling tools
- (51) **Klasse:** 08-01
- (72) **Designer:** Ian Kirk, The Birches Dalmuinzie Road, AB159EB BIELDSIDE, Storbritannia (GB)
Nathan Kirk, 40 Hutcheon Low Place, AB219WL ABERDEEN, Storbritannia (GB)
- (30) **Prioritet:** 2017.08.22, EM, 004158376, 1, 2, 3, 4, 5, 6, 7, 8, 9, 10
- (55) **Designavbildninger:**



6.1

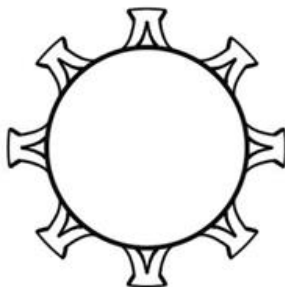

6.2

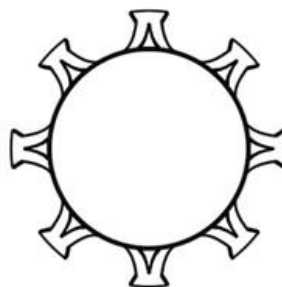

6.3

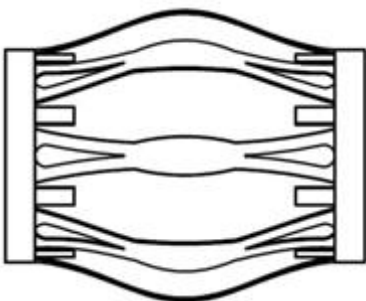

6.4

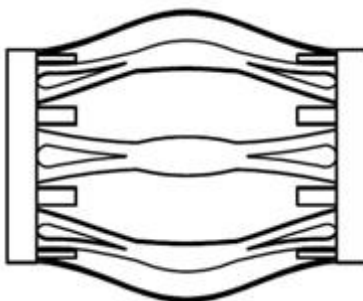

6.5

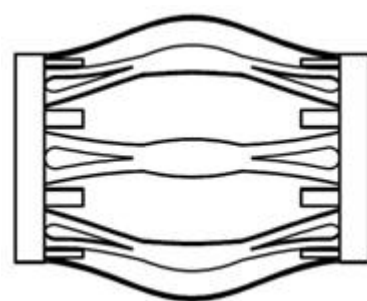

6.6

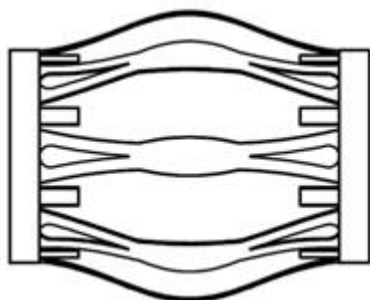

6.7

Design 7

- (54) **Produkt:** Drilling tools
- (51) **Klasse:** 08-01
- (72) **Designer:** Ian Kirk, The Birches Dalmuinzie Road, AB159EB BIELDSIDE, Storbritannia (GB)
Nathan Kirk, 40 Hutcheon Low Place, AB219WL ABERDEEN, Storbritannia (GB)
- (30) **Prioritet:** 2017.08.22, EM, 004158376, 1, 2, 3, 4, 5, 6, 7, 8, 9, 10
- (55) **Designavbildninger:**

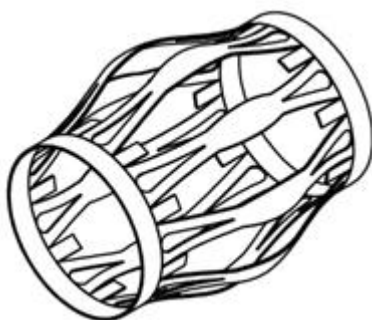

7.1

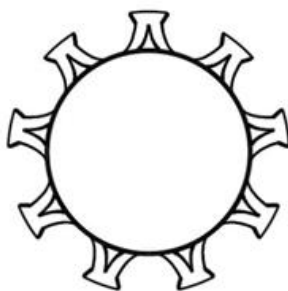

7.2

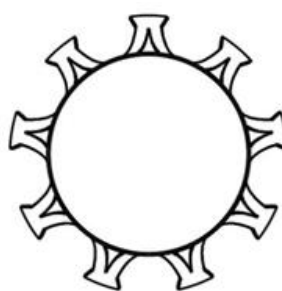

7.3

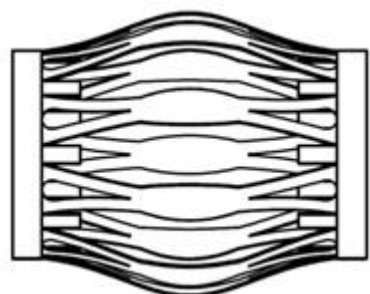

7.4

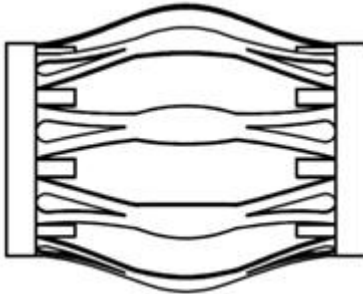

7.5

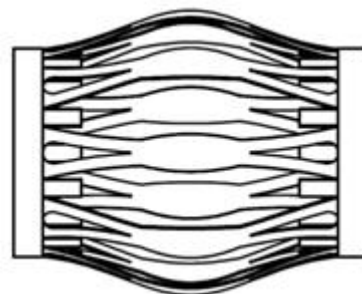

7.6

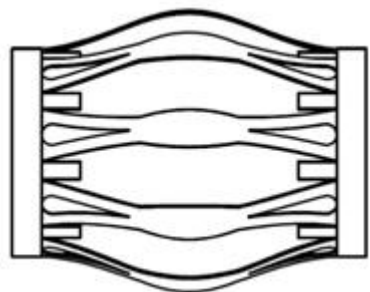

7.7

Design 8

- (54) **Produkt:** Drilling tools
 (51) **Klasse:** 08-01
 (72) **Designer:** Ian Kirk, The Birches Dalmuinzie Road, AB159EB BIELDSIDE, Storbritannia (GB)
 Nathan Kirk, 40 Hutcheon Low Place, AB219WL ABERDEEN, Storbritannia (GB)
 (30) **Prioritet:** 2017.08.22, EM, 004158376, 1, 2, 3, 4, 5, 6, 7, 8, 9, 10
 (55) **Designavbildninger:**



8.1

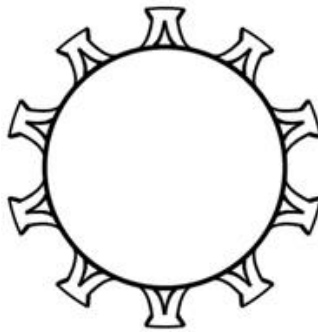

8.2

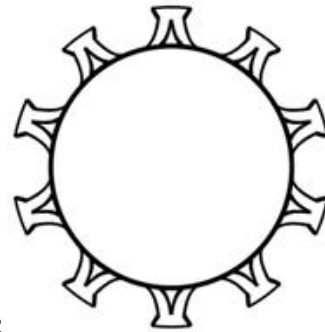

8.3

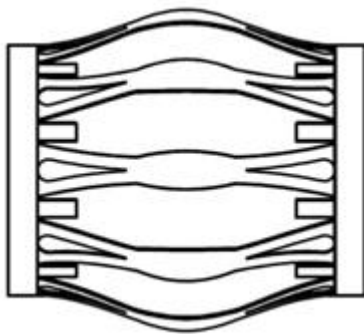

8.4

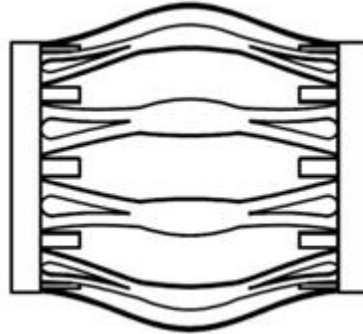

8.5

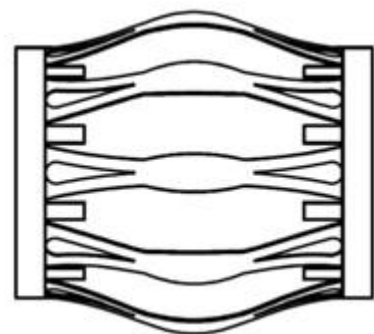

8.6

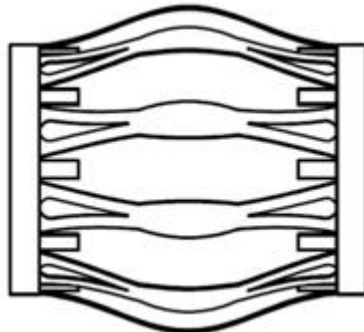

8.7

Design 9

- (54) **Produkt:** Drilling tools
 (51) **Klasse:** 08-01
 (72) **Designer:** Ian Kirk, The Birches Dalmuinzie Road, AB159EB BIELDSIDE, Storbritannia (GB)
 Nathan Kirk, 40 Hutcheon Low Place, AB219WL ABERDEEN, Storbritannia (GB)
 (30) **Prioritet:** 2017.08.22, EM, 004158376, 1, 2, 3, 4, 5, 6, 7, 8, 9, 10
 (55) **Designavbildninger:**



9.1

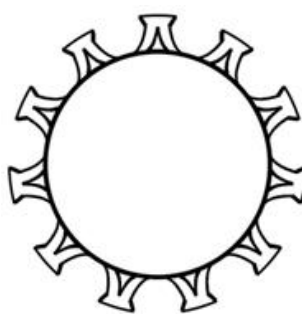

9.2

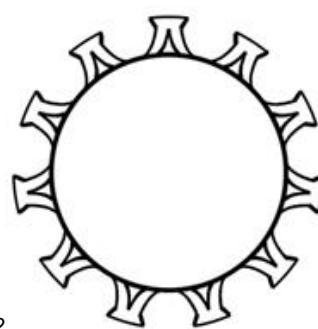

9.3

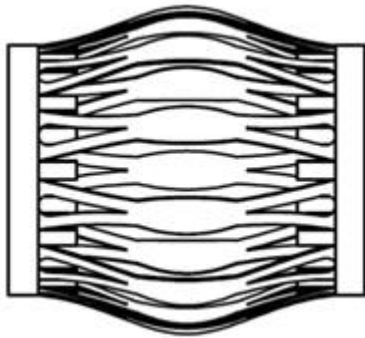

9.4

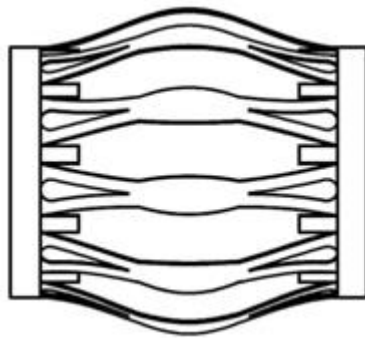

9.5

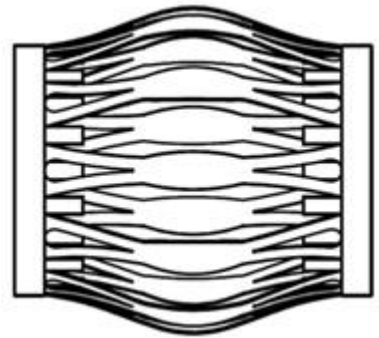

9.6

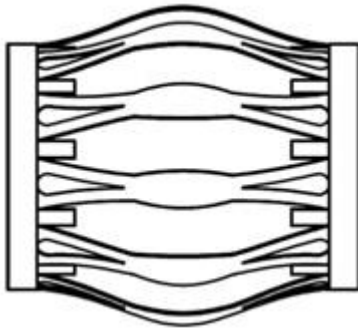

9.7

Design 10

- (54) **Produkt:** Drilling tools
- (51) **Klasse:** 08-01
- (72) **Designer:** Ian Kirk, The Birches Dalmuinzie Road, AB159EB BIELDSIDE, Storbritannia (GB)
Nathan Kirk, 40 Hutcheon Low Place, AB219WL ABERDEEN, Storbritannia (GB)
- (30) **Prioritet:** 2017.08.22, EM, 004158376, 1, 2, 3, 4, 5, 6, 7, 8, 9, 10
- (55) **Designavbildninger:**



10.1

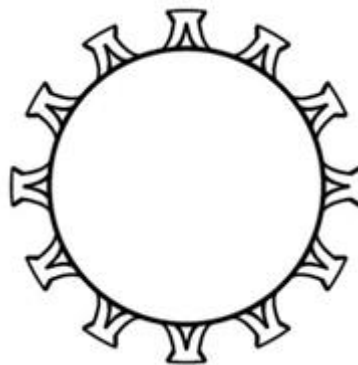

10.2

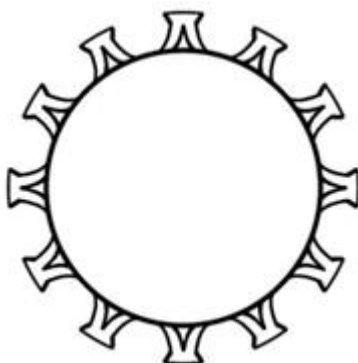

10.3

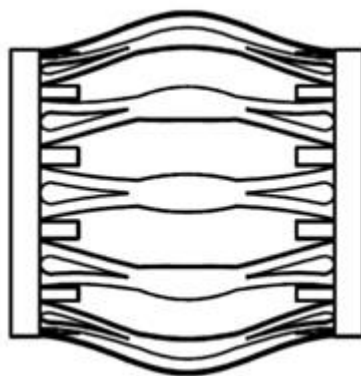

10.4

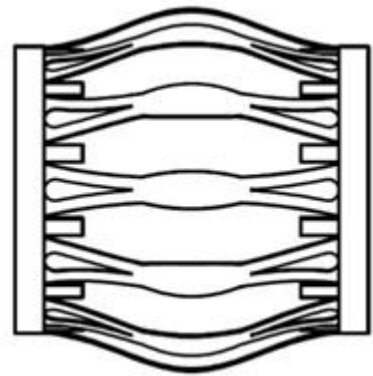

10.5

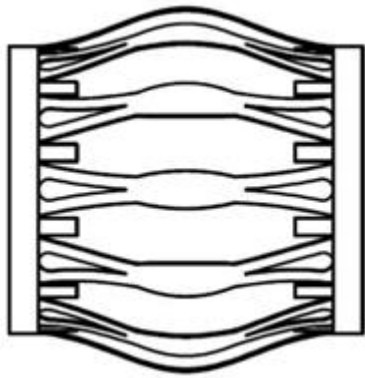

10.6

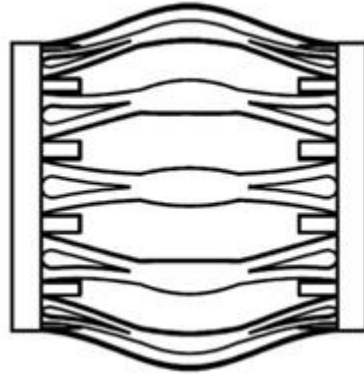

10.7

(11) Reg.nr.:	DM/100797
(21) Søkn.nr.:	20180434
(22) Inngitt i WIPO:	2018.04.09
(15) Registrert i WIPO:	2018.04.09
(24) Løpedag:	2018.04.09
(43) Allm. tilgj.:	2018.05.04
(15) Besluttet gjeldende NO:	2018.06.18
(45) Kunngjort NO:	2018.07.16
(18) Reg. gjelder til:	2023.04.09
(73) Innehaver:	OBER ALP S.P.A., Via Waltraud Gebert Deeg Str., 4, IT-39100 BOLZANO, Italia
(50) Anmerkninger:	Registreringen gjelder samregistrering.

Design 1

(54) Produkt:	Surface patterns applied to a shoe
(51) Klasse:	02-04
(72) Designer:	Enrico Buccioli, c/o OBER ALP S.P.A., Via Waltraud Gebert Deeg Strasse, 4, 39100 BOLZANO, Italia (IT) Elitsa Taneva, c/o OBER ALP S.P.A., Via Waltraud Gebert Deeg Strasse, 4, 39100 BOLZANO, Italia (IT) Edoardo Stocco, c/o OBER ALP S.P.A., Via Waltraud Gebert Deeg Strasse, 4, 39100 BOLZANO, Italia (IT)
(55) Designavbildninger:	

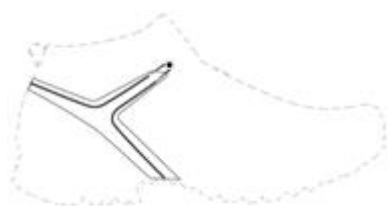

1.1

Design 2

(54) Produkt:	Surface patterns applied to a shoe
(51) Klasse:	02-04
(72) Designer:	Enrico Buccioli, c/o OBER ALP S.P.A., Via Waltraud Gebert Deeg Strasse, 4, 39100 BOLZANO, Italia (IT) Elitsa Taneva, c/o OBER ALP S.P.A., Via Waltraud Gebert Deeg Strasse, 4, 39100 BOLZANO, Italia (IT) Edoardo Stocco, c/o OBER ALP S.P.A., Via Waltraud Gebert Deeg Strasse, 4, 39100 BOLZANO, Italia (IT)
(55) Designavbildninger:	

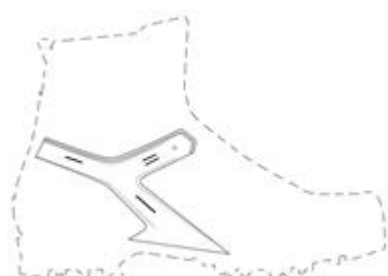

2.1

Design 3

- (54) **Produkt:** Surface patterns applied to a shoe
(51) **Klasse:** 02-04
(72) **Designer:** Enrico Buccioli, c/o OBER ALP S.P.A., Via Waltraud Gebert Deeg Strasse, 4, 39100 BOLZANO, Italia (IT)
Elitsa Taneva, c/o OBER ALP S.P.A., Via Waltraud Gebert Deeg Strasse, 4, 39100 BOLZANO, Italia (IT)
Edoardo Stocco, c/o OBER ALP S.P.A., Via Waltraud Gebert Deeg Strasse, 4, 39100 BOLZANO, Italia (IT)

(55) **Designavbildninger:**

3.1

(11) Reg.nr.:	DM/100798
(21) Søkn.nr.:	20180435
(22) Inngitt i WIPO:	2018.04.06
(15) Registrert i WIPO:	2018.04.06
(24) Løpedag:	2018.04.06
(43) Allm. tilgj.:	2018.05.04
(15) Besluttet gjeldende NO:	2018.06.18
(45) Kunngjort NO:	2018.07.16
(18) Reg. gjelder til:	2023.04.06
(73) Innehaver:	Bayer Intellectual Property GmbH, Alfred-Nobel-Strasse 10, DE-40789 MONHEIM AM RHEIN, Tyskland

Design 1

(54) Produkt:	Spatula for medical use
(51) Klasse:	24-02
(72) Designer:	Bruno Chazel, 20 Impasse Des Écureuils, 38500 VOIRON, Frankrike (FR)
(30) Prioritet:	2017.11.07, EM, 004497238, 1
(55) Designavbildninger:	

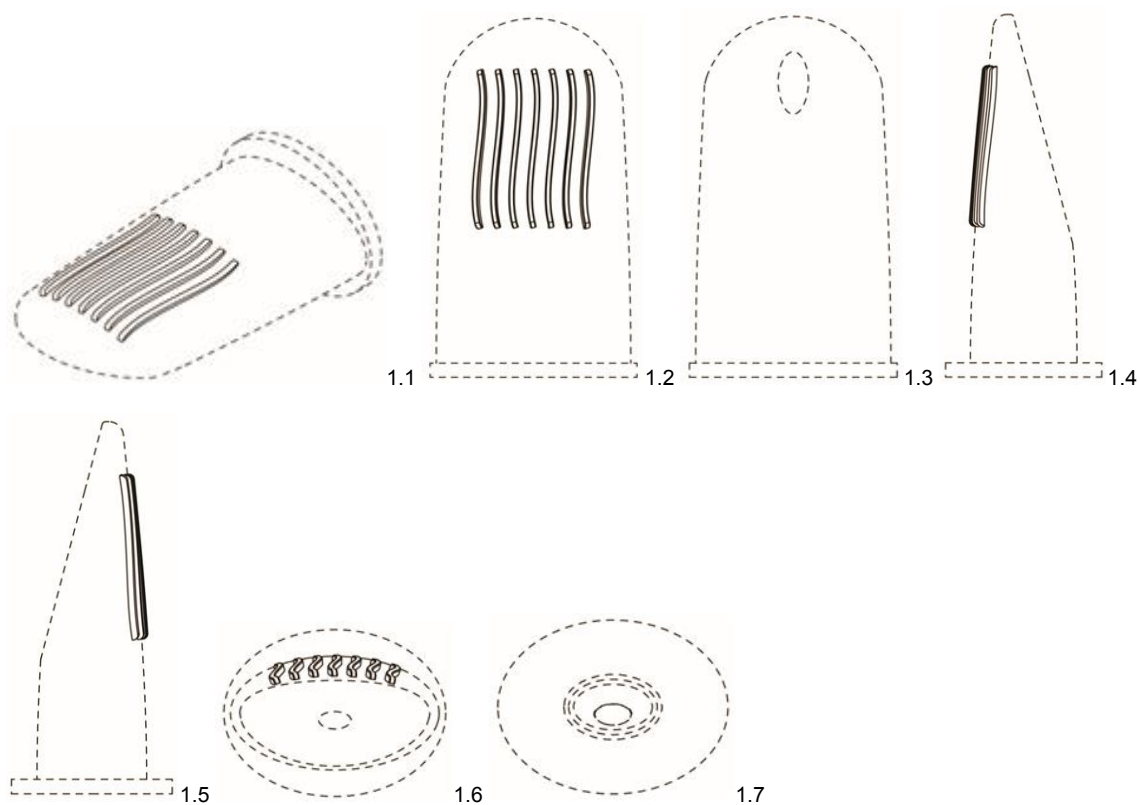

(11)	Reg.nr.:	DM/100800
(21)	Søkn.nr.:	20180436
(22)	Inngitt i WIPO:	2018.04.09
(15)	Registrert i WIPO:	2018.04.09
(24)	Løpedag:	2018.04.09
(43)	Allm. tilgj.:	2018.05.04
(15)	Besluttet gjeldende NO:	2018.06.18
(45)	Kunngjort NO:	2018.07.16
(18)	Reg. gjelder til:	2023.04.09
(73)	Innehaver:	OBER ALP S.P.A., Via Waltraud Gebert Deeg Str., 4, IT-39100 BOLZANO, Italia
(50)	Anmerkninger:	Registreringen gjelder samregistrering.

Design 1

(54)	Produkt:	Parts of Rucksacks
(51)	Klasse:	03-01
(72)	Designer:	Mario Malarček, c/o OBER ALP S.P.A., Via Waltraud Gebert Deeg Strasse, 4, 39100 BOLZANO, Italia (IT)
(55)	Designavbildninger:	

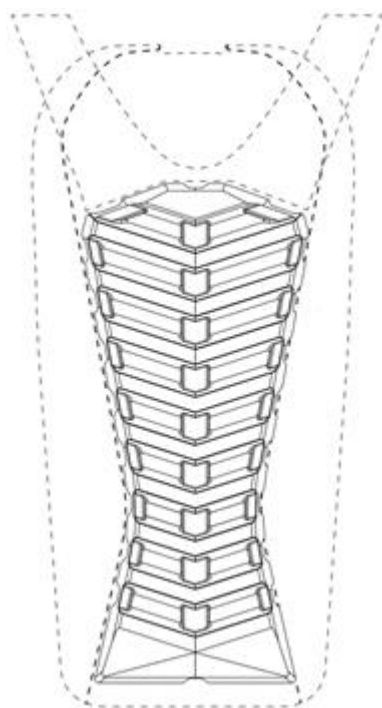

1.1

Design 2

- (54) **Produkt:** Parts of Rucksacks
(51) **Klasse:** 03-01
(72) **Designer:** Mario Malarcsek, c/o OBER ALP S.P.A., Via Waltraud Gebert Deeg Strasse, 4, 39100 BOLZANO, Italia (IT)
- (55) **Designavbildninger:**

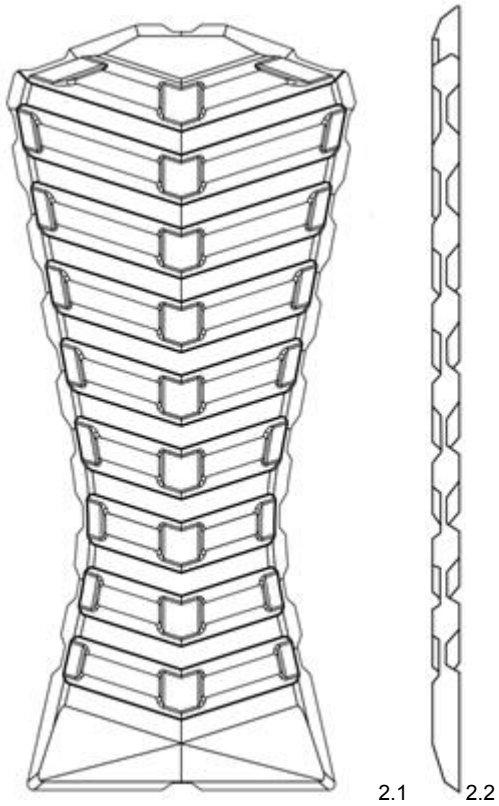

Design 3

- (54) **Produkt:** Parts of Rucksacks
(51) **Klasse:** 03-01
(72) **Designer:** Mario Malarcsek, c/o OBER ALP S.P.A., Via Waltraud Gebert Deeg Strasse, 4, 39100 BOLZANO, Italia (IT)
(55) **Designavbildninger:**

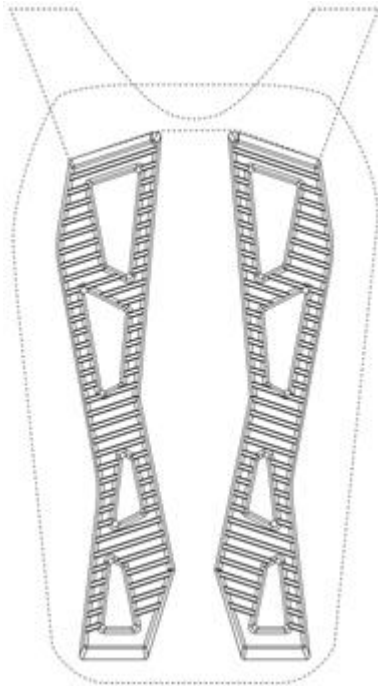

3.1

Design 4

- (54) **Produkt:** Parts of Rucksacks
(51) **Klasse:** 03-01
(72) **Designer:** Mario Malarcsek, c/o OBER ALP S.P.A., Via Waltraud Gebert Deeg Strasse, 4, 39100 BOLZANO, Italia (IT)
(55) **Designavbildninger:**

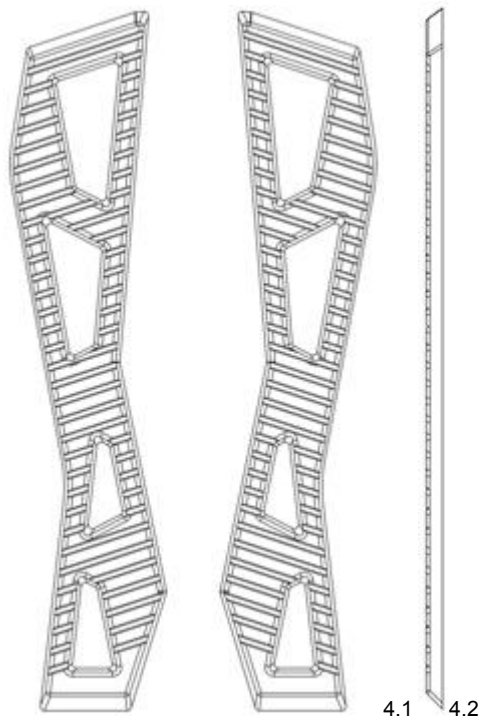

4.1 4.2

(11) Reg.nr.:	DM/100824
(21) Søkn.nr.:	20180437
(22) Inngitt i WIPO:	2018.03.28
(15) Registrert i WIPO:	2018.03.28
(24) Løpedag:	2018.03.28
(43) Allm. tilgj.:	2018.05.04
(15) Besluttet gjeldende NO:	2018.06.18
(45) Kunngjort NO:	2018.07.16
(18) Reg. gjelder til:	2023.03.28
(73) Innehaver:	TEHNOPRO D.O.O., Sirinecka 20a, HR-10000 ZAGREB, Kroatia
(50) Anmerkninger:	Registreringen gjelder samregistrering.

Design 1

(54) Produkt:	Containers for powdery substance with metering device
(51) Klasse:	09-01
(72) Designer:	Mihael Cinzek, c/o TEHNOPRO d.o.o., Sirinecka 20a, 10000 ZAGREB, Kroatia (HR)
(55) Designavbildninger:	



1.1



1.2



1.3



1.4



1.5

Design 2

- (54) **Produkt:** Containers for powdery substance with metering device
(51) **Klasse:** 09-01
(72) **Designer:** Mihael Cinzek, c/o TEHNOPRO d.o.o., Sirinecka 20a, 10000 ZAGREB, Croatia (HR)
(55) **Designavbildninger:**



2.1



2.2



2.3



2.4



2.5

(11) Reg.nr.:	DM/100830
(21) Søkn.nr.:	20180438
(22) Inngitt i WIPO:	2018.04.05
(15) Registrert i WIPO:	2018.04.05
(24) Løpedag:	2018.04.05
(43) Allm. tilgj.:	2018.05.04
(15) Besluttet gjeldende NO:	2018.06.19
(45) Kunngjort NO:	2018.07.16
(18) Reg. gjelder til:	2023.04.05
(73) Innehaver:	BREEZE.IT UNTERNEHMERGESELLSCHAFT (HAFTUNGSBESCHRÄNKT), Deipenbecke 10, DE-58452 WITTEN, Tyskland
(50) Anmerkninger:	Registreringen gjelder samregistrering.

Design 1

(54) Produkt:	Selfie stick
(51) Klasse:	14-99
(72) Designer:	Fusheng Wang, 9, Lane 9, Longjing Two District, Sanlian Village, Buji Town, 518112 SHENZHEN CITY, GUANGDONG PROVINCE, Kina (CN)
(30) Prioritet:	2018.01.22, CN, 201830029470 X, 1, 2, 3, 4, 5, 6
(50) Anmerkning:	Designet er i farger.
(55) Designavbildninger:	



Design 2

- (54) **Produkt:** Stands for mobile telephones
(51) **Klasse:** 14-99
(72) **Designer:** Fusheng Wang, 9, Lane 9, Longjing Two District, Sanlian Village, Buji Town, 518112 SHENZHEN CITY, GUANGDONG PROVINCE, Kina (CN)
(30) **Prioritet:** 2018.01.22, CN, 201830029470 X, 1, 2, 3, 4, 5, 6
(55) **Designavbildninger:**



Design 3

- (54) **Produkt:** Stands for mobile telephones
(51) **Klasse:** 14-99
(72) **Designer:** Fusheng Wang, 9, Lane 9, Longjing Two District, Sanlian Village, Buji Town, 518112 SHENZHEN CITY, GUANGDONG PROVINCE, Kina (CN)
(30) **Prioritet:** 2018.01.22, CN, 201830029470 X, 1, 2, 3, 4, 5, 6
(55) **Designavbildninger:**



3.1



3.2



3.3

Design 4

- (54) **Produkt:** Stands for mobile telephones
(51) **Klasse:** 14-99
(72) **Designer:** Fusheng Wang, 9, Lane 9, Longjing Two District, Sanlian Village, Buji Town, 518112 SHENZHEN CITY, GUANGDONG PROVINCE, Kina (CN)
(30) **Prioritet:** 2018.01.22, CN, 201830029470 X, 1, 2, 3, 4, 5, 6
(50) **Anmerkning:** Designet er i farger.
(55) **Designavbildninger:**



4.1



4.2



4.3

Design 5

- (54) **Produkt:** Stand for audiovisual appliance
(51) **Klasse:** 14-99
(72) **Designer:** Fusheng Wang, 9, Lane 9, Longjing Two District, Sanlian Village, Buji Town, 518112 SHENZHEN CITY, GUANGDONG PROVINCE, Kina (CN)
(30) **Prioritet:** 2018.01.22, CN, 201830029470 X, 1, 2, 3, 4, 5, 6
(50) **Anmerkning:** Designet er i farger.
(55) **Designavbildninger:**



5.1



5.2



5.3

Design 6

- (54) **Produkt:** Stand for mobile telephones
(51) **Klasse:** 14-99
(72) **Designer:** Fusheng Wang, 9, Lane 9, Longjing Two District, Sanlian Village, Buji Town, 518112 SHENZHEN CITY, GUANGDONG PROVINCE, Kina (CN)
(30) **Prioritet:** 2018.01.22, CN, 201830029470 X, 1, 2, 3, 4, 5, 6
(50) **Anmerkning:** Designet er i farger.
(55) **Designavbildninger:**



6.1



6.2



6.3

(11) Reg.nr.:	DM/100844
(21) Søkn.nr.:	20180447
(22) Inngitt i WIPO:	2018.04.20
(15) Registrert i WIPO:	2018.04.20
(24) Løpedag:	2018.04.20
(43) Allm. tilgj.:	2018.05.11
(15) Besluttet gjeldende NO:	2018.06.25
(45) Kunngjort NO:	2018.07.16
(18) Reg. gjelder til:	2023.04.20
(73) Innehaver:	HMD GLOBAL OY, Karaportti 2, FI-02610 ESBO, Finland
(50) Anmerkninger:	Registreringen gjelder samregistrering.

Design 1

(54) Produkt:	Mobile telephones
(51) Klasse:	14-03
(72) Designer:	Jonathon Lister, 2 Goddington Manor, Court Road, BR69AT ORPINGTON, Storbritannia (GB)
(30) Prioritet:	2017.11.14, EM, 004506558, 1, 2
(55) Designavbildninger:	

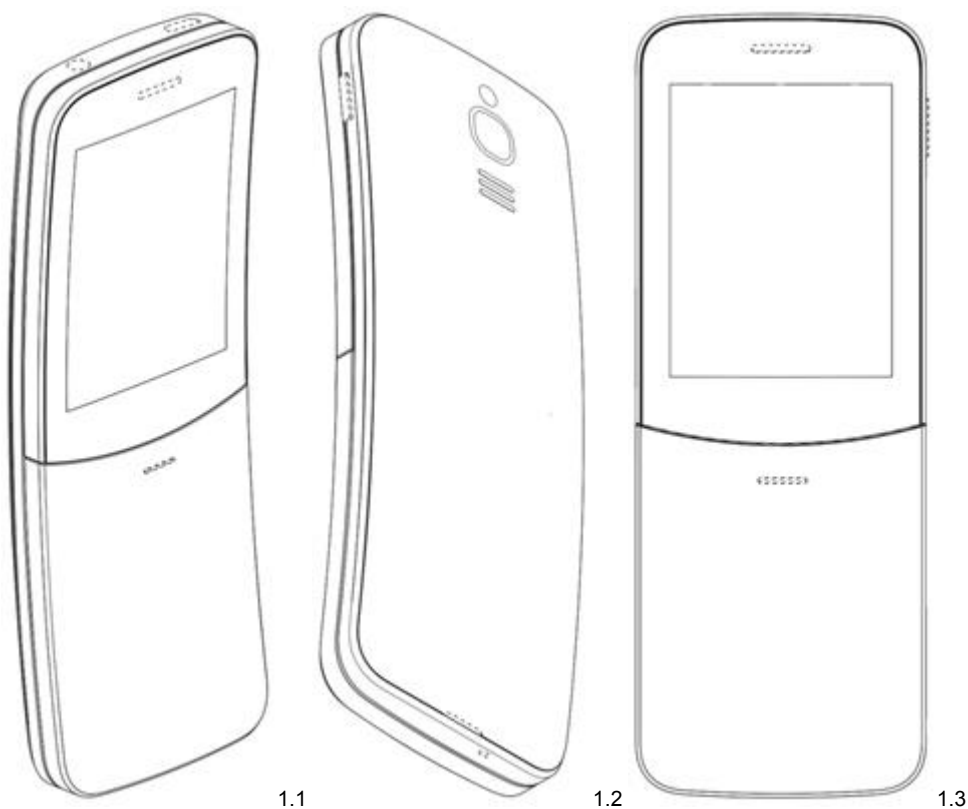

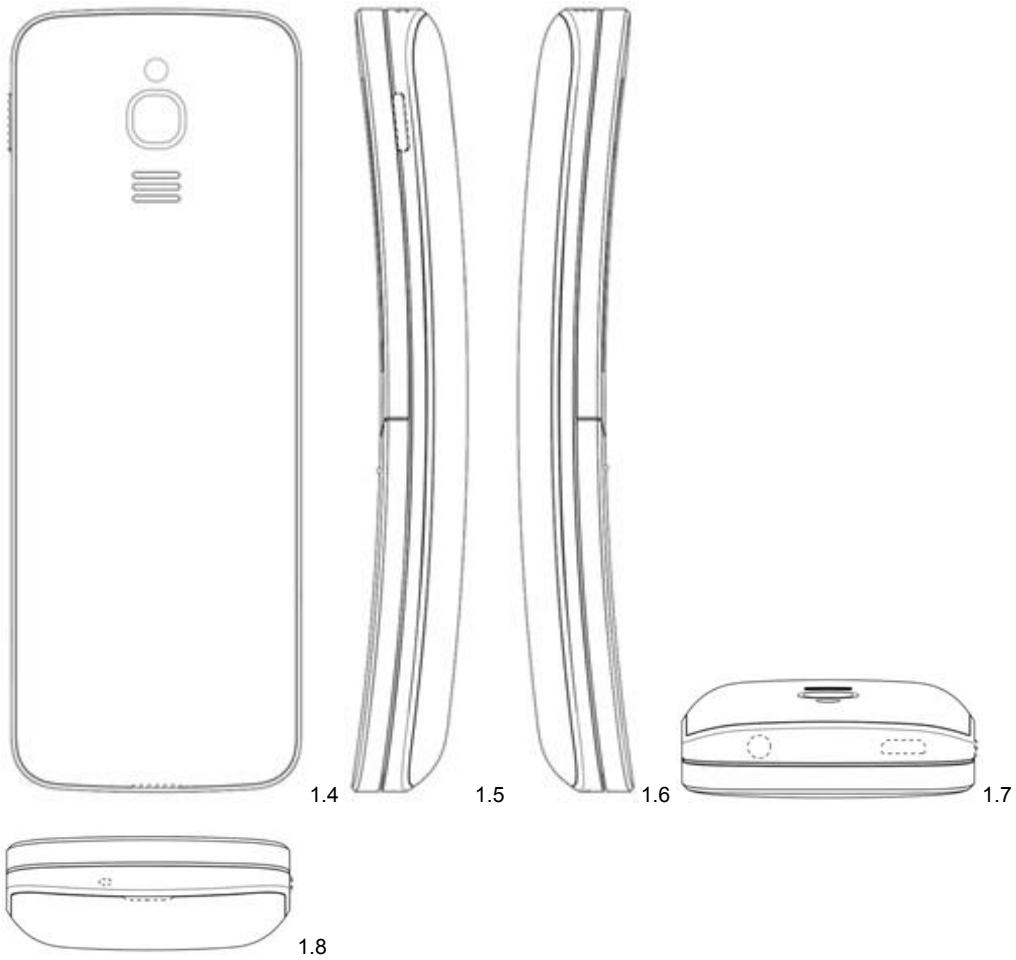

Design 2

- (54) **Produkt:** Mobile telephones
(51) **Klasse:** 14-03
(72) **Designer:** Jonathon Lister, 2 Goddington Manor, Court Road, BR69AT ORPINGTON, Storbritannia (GB)
(30) **Prioritet:** 2017.11.14, EM, 004506558, 1, 2
(55) **Designavbildninger:**

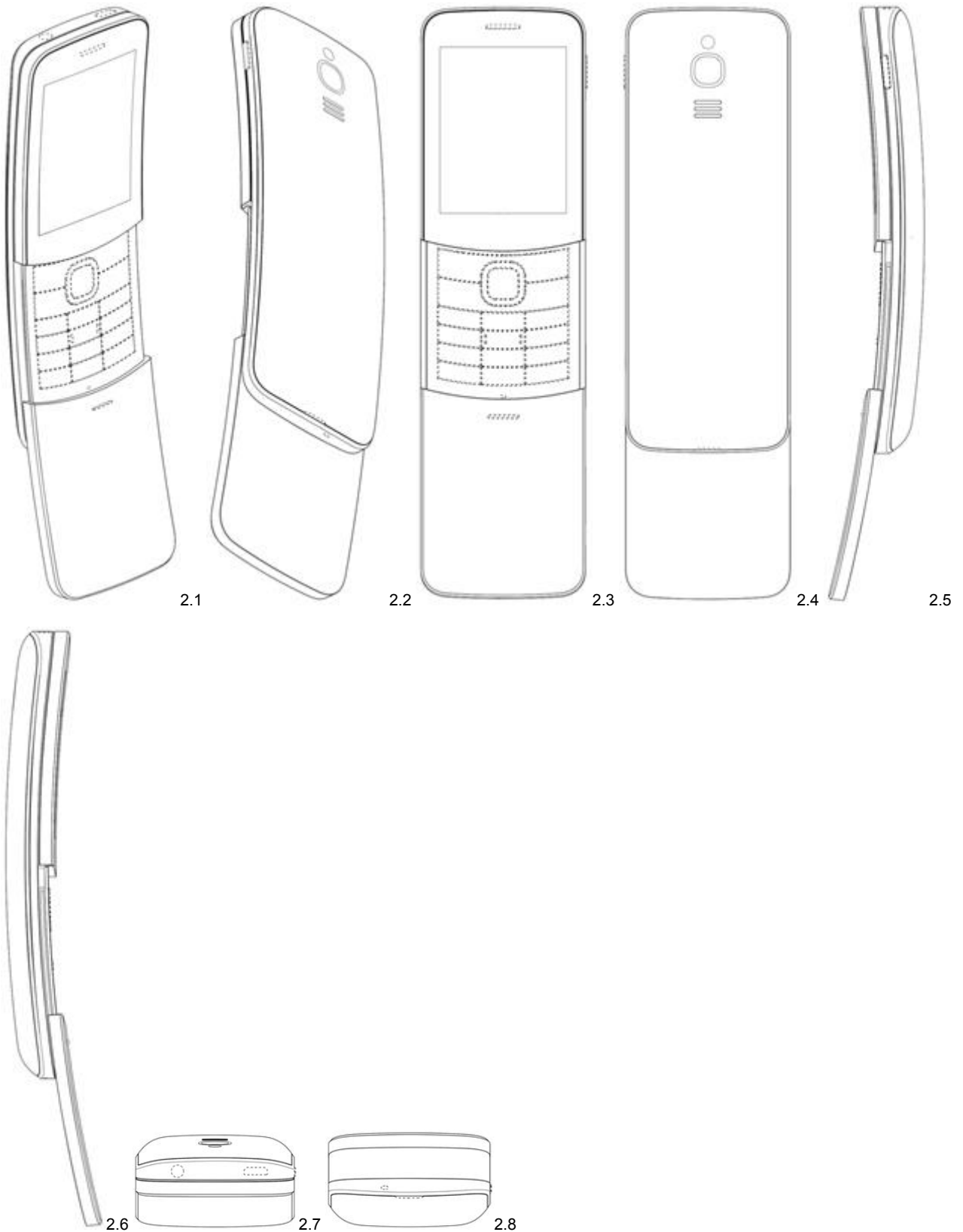

(11)	Reg.nr.:	DM/100861
(21)	Søkn.nr.:	20180448
(22)	Inngitt i WIPO:	2018.03.09
(15)	Registrert i WIPO:	2018.03.09
(24)	Løpedag:	2018.03.09
(43)	Allm. tilgj.:	2018.05.11
(15)	Besluttet gjeldende NO:	2018.06.25
(45)	Kunngjort NO:	2018.07.16
(18)	Reg. gjelder til:	2023.03.09
(73)	Innehaver:	G.LICHTER S.À.R.L, 17A, Ceinture des Rosiers, LU-2446 HOWALD, Luxembourg

Design 1

(54)	Produkt:	Removable holder for a protective band for frying pans and saucepans
(51)	Klasse:	07-99
(72)	Designer:	Gilbert Lichter, 17A, Ceinture des Rosiers, 2446 HOWALD, Luxembourg (LU)
(55)	Designavbildninger:	

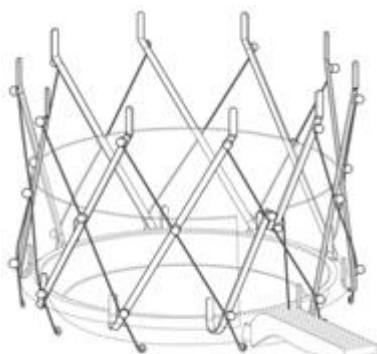

1.1



1.2

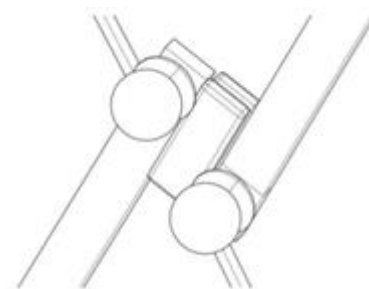

1.3

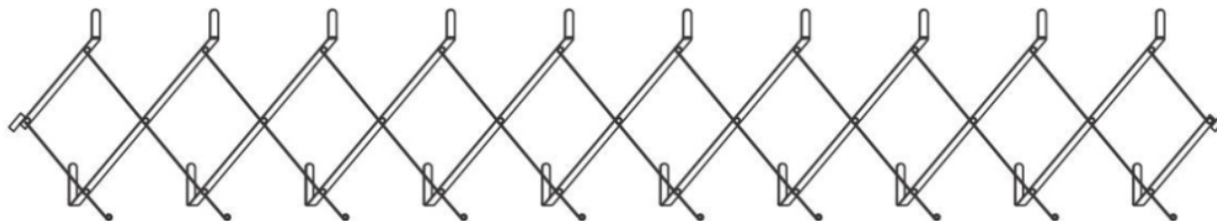

1.4

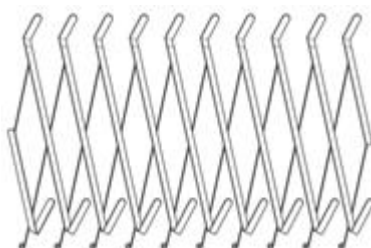

1.5



1.6



1.7

(11)	Reg.nr.:	DM/100877
(21)	Søkn.nr.:	20180450
(22)	Inngitt i WIPO:	2017.09.20
(15)	Registrert i WIPO:	2017.09.20
(24)	Løpedag:	2017.09.20
(43)	Allm. tilgj.:	2018.05.11
(15)	Besluttet gjeldende NO:	2018.06.25
(45)	Kunngjort NO:	2018.07.16
(18)	Reg. gjelder til:	2022.09.20
(73)	Innehaver:	Theresia Le Battistini, Weinbergstrasse 10, CH-8807 FREIENBACH, Sveits

Design 1

(54)	Produkt:	Doll's head
(51)	Klasse:	21-01
(72)	Designer:	Theresia Le Battistini, Weinbergstrasse 10, 8807 FREIENBACH, Sveits (CH)
(55)	Designavbildninger:	



1.1

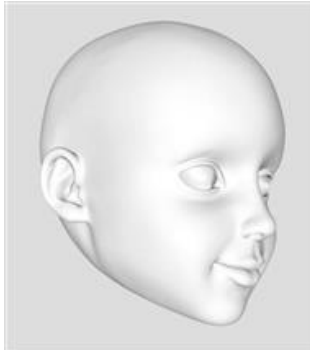

1.2

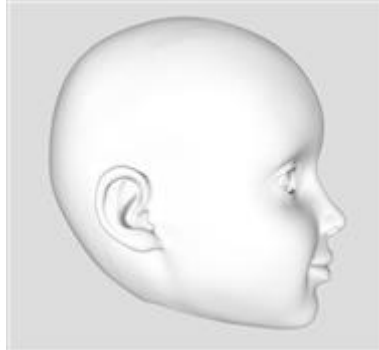

1.3

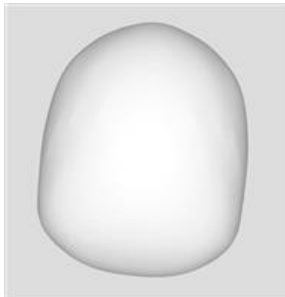

1.4

(11)	Reg.nr.:	DM/100891
(21)	Søkn.nr.:	20180451
(22)	Inngitt i WIPO:	2018.04.11
(15)	Registrert i WIPO:	2018.04.11
(24)	Løpedag:	2018.04.11
(43)	Allm. tilgj.:	2018.05.11
(15)	Besluttet gjeldende NO:	2018.06.25
(45)	Kunngjort NO:	2018.07.16
(18)	Reg. gjelder til:	2023.04.11
(73)	Innehaver:	KRONOPLUS LIMITED, Grayoak House 9 Tagmatarchou Poulou Street, CY-1101 AYIOS ANDREAS NICOSIA, Kypros
(50)	Anmerkninger:	Registreringen gjelder samregistrering.

Design 12

(54)	Produkt:	Surface patterns
(51)	Klasse:	32-00
(72)	Designer:	Gerhard Dürnberger, Holsteingasse 33, 5204 STRASSWALCHEN, Østerrike (AT)
(50)	Anmerkning:	Designet er i farger.
(55)	Designavbildninger:	



12.1

Design 13

(54)	Produkt:	Surface patterns
(51)	Klasse:	32-00
(72)	Designer:	Gerhard Dürnberger, Holsteingasse 33, 5204 STRASSWALCHEN, Østerrike (AT)
(50)	Anmerkning:	Designet er i farger.
(55)	Designavbildninger:	



13.1

Design 14

(54)	Produkt:	Surface patterns
(51)	Klasse:	32-00
(72)	Designer:	Gerhard Dürnberger, Holsteingasse 33, 5204 STRASSWALCHEN, Østerrike (AT)
(55)	Designavbildninger:	



14.1

Design 15

- (54) **Produkt:** Surface patterns
(51) **Klasse:** 32-00
(72) **Designer:** Gerhard Dürnberger, Holsteingasse 33, 5204 STRASSWALCHEN, Østerrike (AT)
(50) **Anmerkning:** Designet er i farger.
(55) **Designavbildninger:**



15.1

Design 16

- (54) **Produkt:** Surface patterns
(51) **Klasse:** 32-00
(72) **Designer:** Gerhard Dürnberger, Holsteingasse 33, 5204 STRASSWALCHEN, Østerrike (AT)
(55) **Designavbildninger:**



16.1

Design 17

- (54) **Produkt:** Surface patterns
(51) **Klasse:** 32-00
(72) **Designer:** Gerhard Dürnberger, Holsteingasse 33, 5204 STRASSWALCHEN, Østerrike (AT)
(50) **Anmerking:** Designet er i farger.
(55) **Designavbildninger:**



17.1

Design 18

- (54) **Produkt:** Surface patterns
(51) **Klasse:** 32-00
(72) **Designer:** Gerhard Dürnberger, Holsteingasse 33, 5204 STRASSWALCHEN, Østerrike (AT)
(55) **Designavbildninger:**



18.1

Design 19

- (54) **Produkt:** Surface patterns
(51) **Klasse:** 32-00
(72) **Designer:** Gerhard Dürnberger, Holsteingasse 33, 5204 STRASSWALCHEN, Østerrike (AT)
(50) **Anmerkning:** Designet er i farger.
(55) **Designavbildninger:**



19.1

Design 20

- (54) **Produkt:** Surface patterns
(51) **Klasse:** 32-00
(72) **Designer:** Gerhard Dürnberger, Holsteingasse 33, 5204 STRASSWALCHEN, Østerrike (AT)
(55) **Designavbildninger:**



20.1

Design 21

- (54) **Produkt:** Surface patterns
(51) **Klasse:** 32-00
(72) **Designer:** Gerhard Dürnberger, Holsteingasse 33, 5204 STRASSWALCHEN, Østerrike (AT)
(55) **Designavbildninger:**



21.1

Design 22

- (54) **Produkt:** Surface patterns
(51) **Klasse:** 32-00
(72) **Designer:** Gerhard Dürnberger, Holsteingasse 33, 5204 STRASSWALCHEN, Østerrike (AT)
(55) **Designavbildninger:**



22.1

Design 23

- (54) **Produkt:** Surface patterns
(51) **Klasse:** 32-00
(72) **Designer:** Gerhard Dürnberger, Holsteingasse 33, 5204 STRASSWALCHEN, Østerrike (AT)
(55) **Designavbildninger:**



23.1

Design 24

- (54) **Produkt:** Surface patterns
(51) **Klasse:** 32-00
(72) **Designer:** Gerhard Dürnberger, Holsteingasse 33, 5204 STRASSWALCHEN, Østerrike (AT)
(55) **Designavbildninger:**



24.1

Design 1

- (54) **Produkt:** Surface patterns
(51) **Klasse:** 32-00
(72) **Designer:** Gerhard Dürnberger, Holsteingasse 33, 5204 STRASSWALCHEN, Østerrike (AT)
(50) **Anmerkning:** Designet er i farger.
(55) **Designavbildninger:**



1.1

Design 2

- (54) **Produkt:** Surface patterns
(51) **Klasse:** 32-00
(72) **Designer:** Gerhard Dürnberger, Holsteingasse 33, 5204 STRASSWALCHEN, Østerrike (AT)
(55) **Designavbildninger:**



2.1

Design 3

- (54) **Produkt:** Surface patterns
(51) **Klasse:** 32-00
(72) **Designer:** Gerhard Dürnberger, Holsteingasse 33, 5204 STRASSWALCHEN, Østerrike (AT)
(50) **Anmerkning:** Designet er i farger.
(55) **Designavbildninger:**



3.1

Design 4

- (54) **Produkt:** Surface patterns
(51) **Klasse:** 32-00
(72) **Designer:** Gerhard Dürnberger, Holsteingasse 33, 5204 STRASSWALCHEN, Østerrike (AT)
(55) **Designavbildninger:**

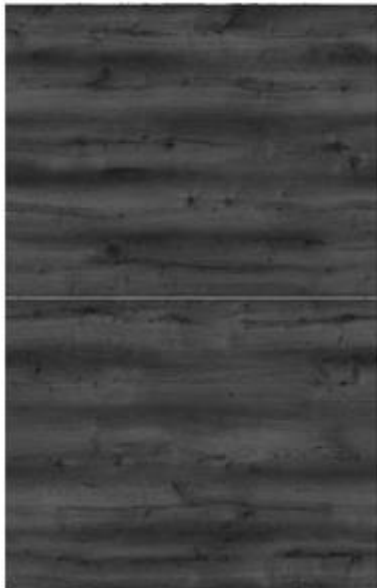

4.1

Design 5

- (54) **Produkt:** Surface patterns
(51) **Klasse:** 32-00
(72) **Designer:** Gerhard Dürnberger, Holsteingasse 33, 5204 STRASSWALCHEN, Østerrike (AT)
(50) **Anmerkning:** Designet er i farger.
(55) **Designavbildninger:**

**Design 6**

- (54) **Produkt:** Surface patterns
(51) **Klasse:** 32-00
(72) **Designer:** Gerhard Dürnberger, Holsteingasse 33, 5204 STRASSWALCHEN, Østerrike (AT)
(55) **Designavbildninger:**



Design 7

- (54) **Produkt:** Surface patterns
(51) **Klasse:** 32-00
(72) **Designer:** Gerhard Dürnberger, Holsteingasse 33, 5204 STRASSWALCHEN, Østerrike (AT)
(50) **Anmerkning:** Designet er i farger.
(55) **Designavbildninger:**



7.1

Design 8

- (54) **Produkt:** Surface patterns
(51) **Klasse:** 32-00
(72) **Designer:** Gerhard Dürnberger, Holsteingasse 33, 5204 STRASSWALCHEN, Østerrike (AT)
(55) **Designavbildninger:**



8.1

Design 9

- (54) **Produkt:** Surface patterns
(51) **Klasse:** 32-00
(72) **Designer:** Gerhard Dürnberger, Holsteingasse 33, 5204 STRASSWALCHEN, Østerrike (AT)
(50) **Anmerkning:** Designet er i farger.
(55) **Designavbildninger:**



9.1

Design 10

- (54) **Produkt:** Surface patterns
(51) **Klasse:** 32-00
(72) **Designer:** Gerhard Dürnberger, Holsteingasse 33, 5204 STRASSWALCHEN, Østerrike (AT)
(55) **Designavbildninger:**



10.1

Design 11

- (54) **Produkt:** Surface patterns
(51) **Klasse:** 32-00
(72) **Designer:** Gerhard Dürnberger, Holsteingasse 33, 5204 STRASSWALCHEN, Østerrike (AT)
(55) **Designavbildninger:**



11.1

(11)	Reg.nr.:	DM/100899
(21)	Søkn.nr.:	20180452
(22)	Inngitt i WIPO:	2018.03.15
(15)	Registrert i WIPO:	2018.03.15
(24)	Løpedag:	2018.03.15
(43)	Allm. tilgj.:	2018.05.11
(15)	Besluttet gjeldende NO:	2018.06.25
(45)	Kunngjort NO:	2018.07.16
(18)	Reg. gjelder til:	2023.03.15
(73)	Innehaver:	MeisterSinger GmbH & Co. KG, Hafenweg 46, DE-48155 MÜNSTER, Tyskland
(50)	Anmerkninger:	Registreringen gjelder samregistrering.

Design 1

(54)	Produkt:	Watch dials
(51)	Klasse:	10-07
(72)	Designer:	Manfred Brassler, Hafenweg 46, 48155 MÜNSTER, Tyskland (DE)
(50)	Anmerkning:	Designet er i farger.
(55)	Designavbildninger:	



1.1

Design 2

(54)	Produkt:	Watch dials
(51)	Klasse:	10-07
(72)	Designer:	Manfred Brassler, Hafenweg 46, 48155 MÜNSTER, Tyskland (DE)
(50)	Anmerkning:	Designet er i farger.
(55)	Designavbildninger:	



2.1

Design 3

- (54) **Produkt:** Watch dials
(51) **Klasse:** 10-07
(72) **Designer:** Manfred Brassler, Hafenweg 46, 48155 MÜNSTER, Tyskland (DE)
(55) **Designavbildninger:**



3.1

Design 4

- (54) **Produkt:** Watch dials
(51) **Klasse:** 10-07
(72) **Designer:** Manfred Brassler, Hafenweg 46, 48155 MÜNSTER, Tyskland (DE)
(55) **Designavbildninger:**



4.1

Design 5

- (54) **Produkt:** Watch dials
(51) **Klasse:** 10-07
(72) **Designer:** Manfred Brassler, Hafenweg 46, 48155 MÜNSTER, Tyskland (DE)
(55) **Designavbildninger:**



5.1

Design 6

- (54) **Produkt:** Watch case
(51) **Klasse:** 10-07
(72) **Designer:** Manfred Brassler, Hafenweg 46, 48155 MÜNSTER, Tyskland (DE)
(55) **Designavbildninger:**

**Design 7**

- (54) **Produkt:** Watch dial
(51) **Klasse:** 10-07
(72) **Designer:** Manfred Brassler, Hafenweg 46, 48155 MÜNSTER, Tyskland (DE)
(55) **Designavbildninger:**

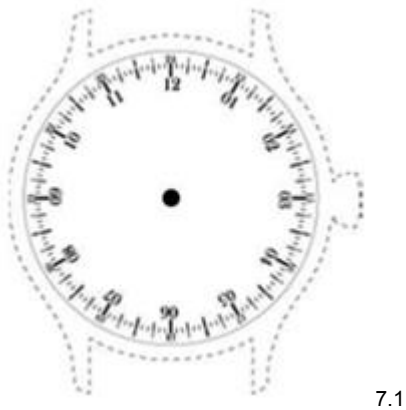
**Design 8**

- (54) **Produkt:** Hand of dial
(51) **Klasse:** 10-07
(72) **Designer:** Manfred Brassler, Hafenweg 46, 48155 MÜNSTER, Tyskland (DE)
(55) **Designavbildninger:**

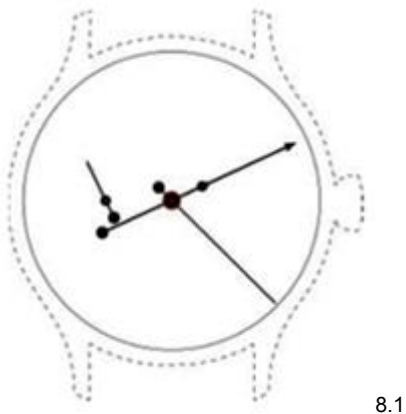

Design 9

- (54) **Produkt:** Watch dials
(51) **Klasse:** 10-07
(72) **Designer:** Manfred Brassler, Hafenweg 46, 48155 MÜNSTER, Tyskland (DE)
(55) **Designavbildninger:**



9.1

Design 10

- (54) **Produkt:** Watch dials
(51) **Klasse:** 10-07
(72) **Designer:** Manfred Brassler, Hafenweg 46, 48155 MÜNSTER, Tyskland (DE)
(55) **Designavbildninger:**



10.1

Design 11

- (54) **Produkt:** Watch dials
(51) **Klasse:** 10-07
(72) **Designer:** Manfred Brassler, Hafenweg 46, 48155 MÜNSTER, Tyskland (DE)
(55) **Designavbildninger:**



11.1

Design 12

- (54) **Produkt:** Watch dials
(51) **Klasse:** 10-07
(72) **Designer:** Manfred Brassler, Hafenweg 46, 48155 MÜNSTER, Tyskland (DE)
(55) **Designavbildninger:**



12.1

Design 13

- (54) **Produkt:** Watch dials
(51) **Klasse:** 10-07
(72) **Designer:** Manfred Brassler, Hafenweg 46, 48155 MÜNSTER, Tyskland (DE)
(50) **Anmerkning:** Designet er i farger.
(55) **Designavbildninger:**



13.1

Design 14

- (54) **Produkt:** Watch dials
(51) **Klasse:** 10-07
(72) **Designer:** Manfred Brassler, Hafenweg 46, 48155 MÜNSTER, Tyskland (DE)
(50) **Anmerkning:** Designet er i farger.
(55) **Designavbildninger:**



14.1

Design 15

- (54) **Produkt:** Watch dials
(51) **Klasse:** 10-07
(72) **Designer:** Manfred Brassler, Hafenweg 46, 48155 MÜNSTER, Tyskland (DE)
(55) **Designavbildninger:**



15.1

Design 16

- (54) **Produkt:** Watch
(51) **Klasse:** 10-02
(72) **Designer:** Manfred Brassler, Hafenweg 46, 48155 MÜNSTER, Tyskland (DE)
(50) **Anmerkning:** Designet er i farger.
(55) **Designavbildninger:**



16.1

Design 17

- (54) **Produkt:** Watch dials
(51) **Klasse:** 10-07
(72) **Designer:** Manfred Brassler, Hafenweg 46, 48155 MÜNSTER, Tyskland (DE)
(55) **Designavbildninger:**



17.1

Design 18

- (54) **Produkt:** Watch dials
(51) **Klasse:** 10-07
(72) **Designer:** Manfred Brassler, Hafenweg 46, 48155 MÜNSTER, Tyskland (DE)
(50) **Anmerkning:** Designet er i farger.
(55) **Designavbildninger:**



18.1

(11)	Reg.nr.:	DM/100921
(21)	Søkn.nr.:	20180453
(22)	Inngitt i WIPO:	2018.03.12
(15)	Registrert i WIPO:	2018.03.12
(24)	Løpedag:	2018.03.12
(43)	Allm. tilgj.:	2018.05.11
(15)	Besluttet gjeldende NO:	2018.06.25
(45)	Kunngjort NO:	2018.07.16
(18)	Reg. gjelder til:	2023.03.12
(73)	Innehaver:	TOMIL s.r.o., Gen. Svatone 149/IV, CZ-56601 VYSOKÉ MÝTO, Den tsjekkiske republikk
(50)	Anmerkninger:	Registreringen gjelder samregistrering.

Design 1

(54)	Produkt:	Toilet rim blocks
(51)	Klasse:	23-02
(72)	Designer:	Tomas Müller, Zamecek 443, 50008 HRADEC KRALOVE, Den tsjekkiske republikk (CZ)
(30)	Prioritet:	2017.10.02, EM, 004382356, 1, 2, 3, 4, 5, 6, 7, 8, 9, 10, 11, 12
(55)	Designavbildninger:	

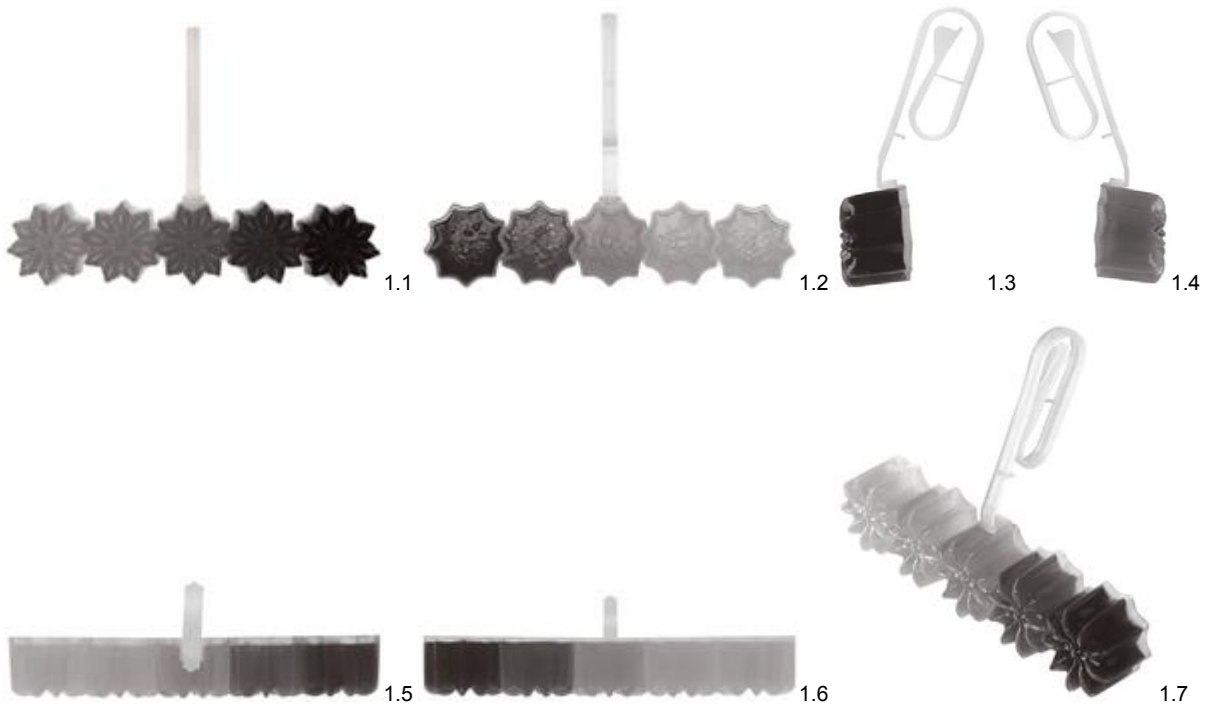
**Design 2**

(54)	Produkt:	Toilet rim blocks
(51)	Klasse:	23-02
(72)	Designer:	Tomas Müller, Zamecek 443, 50008 HRADEC KRALOVE, Den tsjekkiske republikk (CZ)
(30)	Prioritet:	2017.10.02, EM, 004382356, 1, 2, 3, 4, 5, 6, 7, 8, 9, 10, 11, 12
(55)	Designavbildninger:	

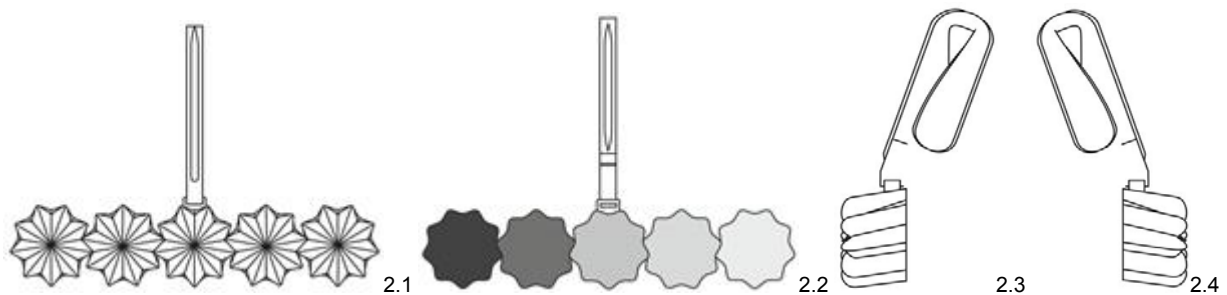

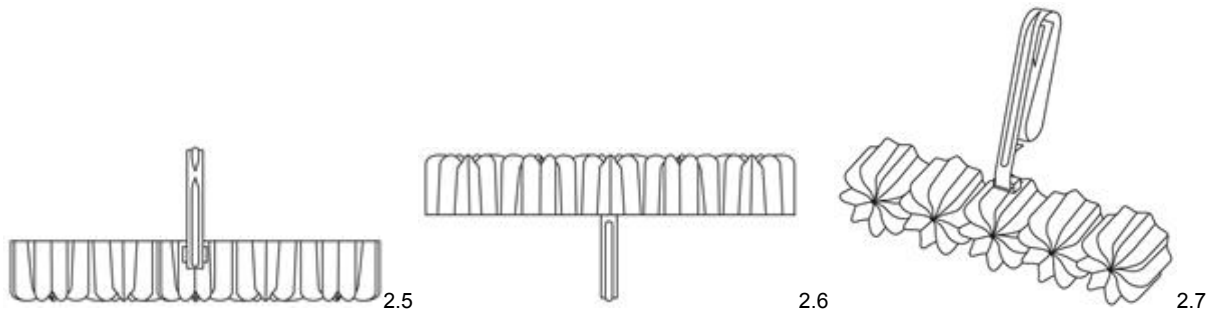
**Design 3**

- (54) **Produkt:** Toilet rim blocks
 (51) **Klasse:** 23-02
 (72) **Designer:** Tomas Müller, Zamecek 443, 50008 HRADEC KRALOVE, Den tsjekkiske republikk (CZ)
 (30) **Prioritet:** 2017.10.02, EM, 004382356, 1, 2, 3, 4, 5, 6, 7, 8, 9, 10, 11, 12
 (55) **Designavbildninger:**

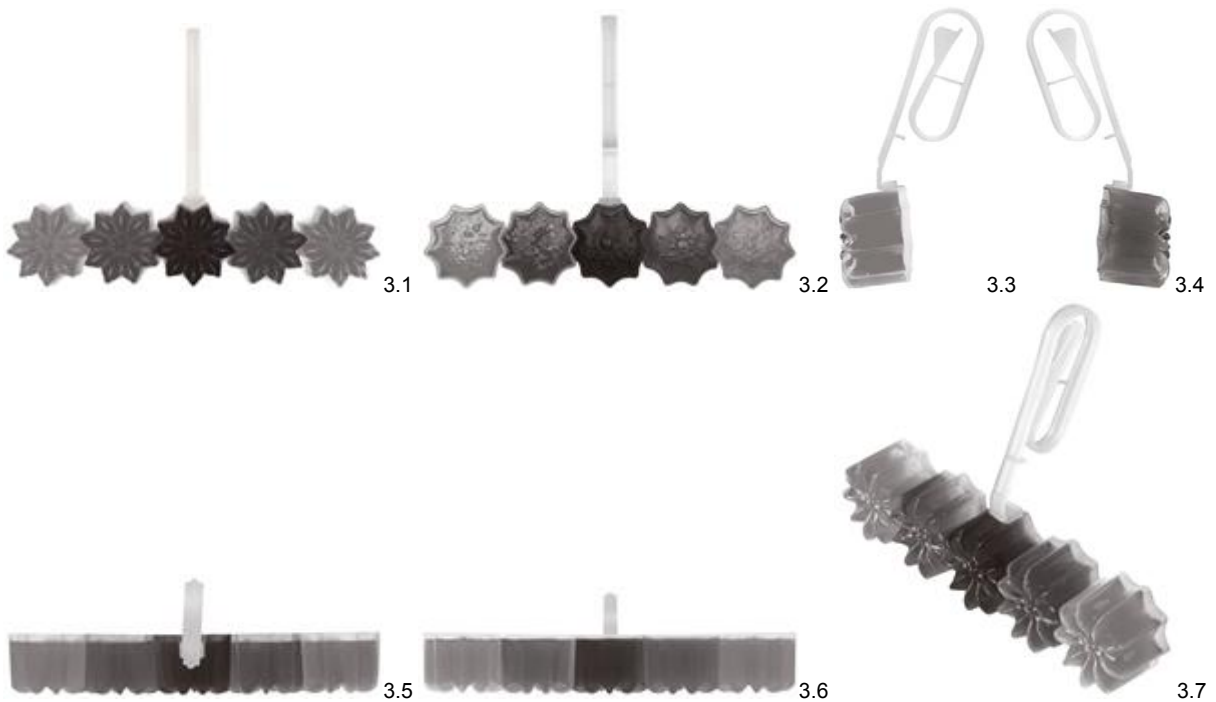
**Design 4**

- (54) **Produkt:** Toilet rim blocks
 (51) **Klasse:** 23-02
 (72) **Designer:** Tomas Müller, Zamecek 443, 50008 HRADEC KRALOVE, Den tsjekkiske republikk (CZ)
 (30) **Prioritet:** 2017.10.02, EM, 004382356, 1, 2, 3, 4, 5, 6, 7, 8, 9, 10, 11, 12
 (55) **Designavbildninger:**

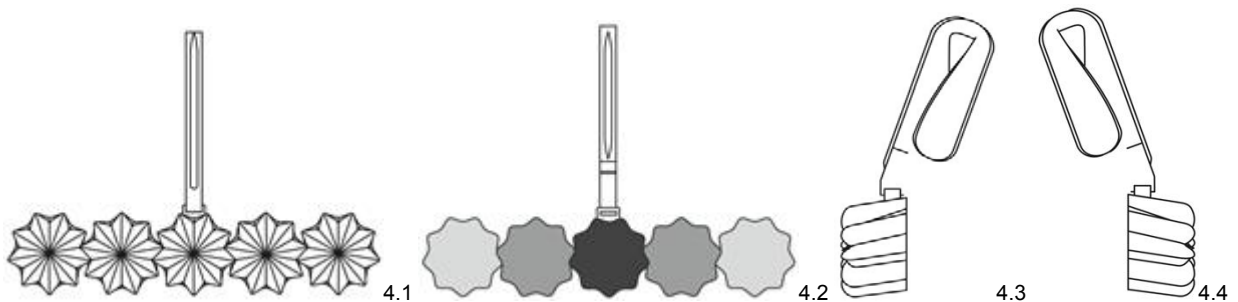

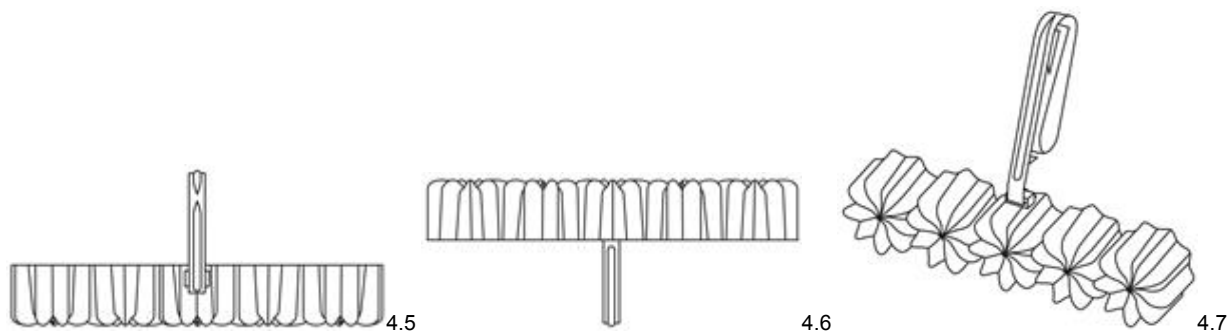
**Design 5**

- (54) **Produkt:** Toilet rim blocks
 (51) **Klasse:** 23-02
 (72) **Designer:** Tomas Müller, Zamecek 443, 50008 HRADEC KRALOVE, Den tsjekkiske republikk (CZ)
 (30) **Prioritet:** 2017.10.02, EM, 004382356, 1, 2, 3, 4, 5, 6, 7, 8, 9, 10, 11, 12
 (55) **Designavbildninger:**

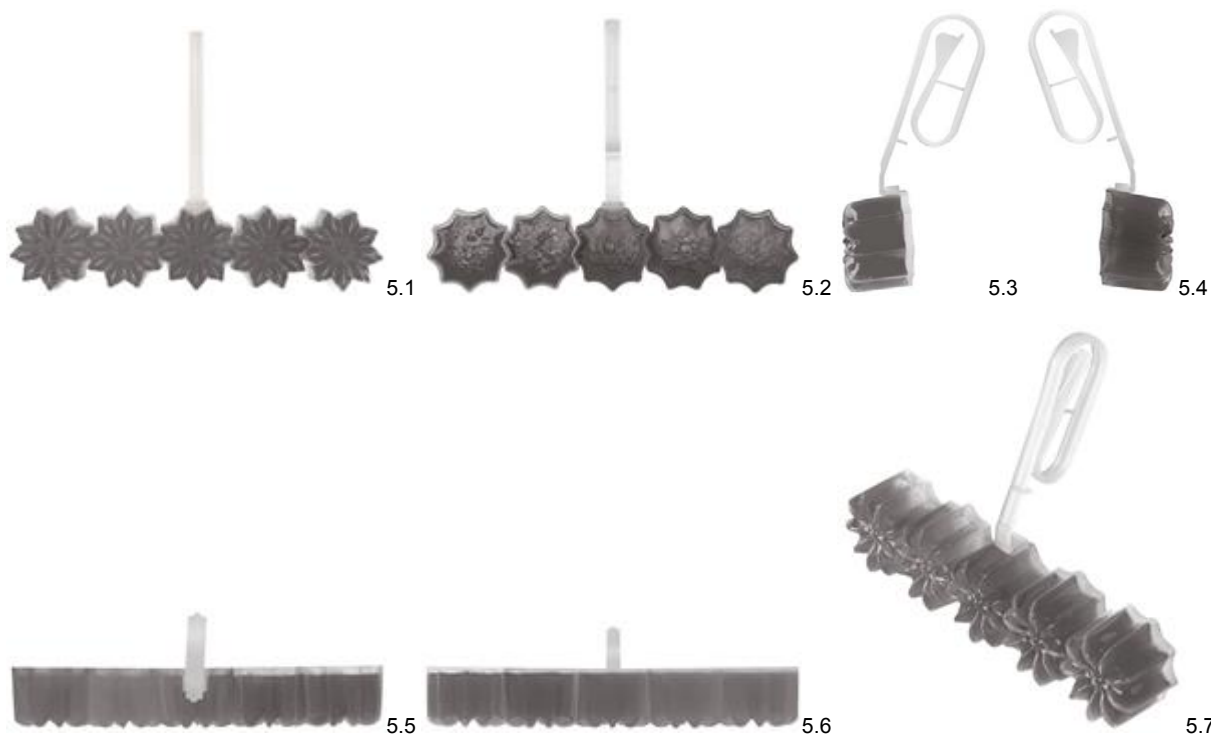
**Design 6**

- (54) **Produkt:** Toilet rim blocks
 (51) **Klasse:** 23-02
 (72) **Designer:** Tomas Müller, Zamecek 443, 50008 HRADEC KRALOVE, Den tsjekkiske republikk (CZ)
 (30) **Prioritet:** 2017.10.02, EM, 004382356, 1, 2, 3, 4, 5, 6, 7, 8, 9, 10, 11, 12
 (55) **Designavbildninger:**

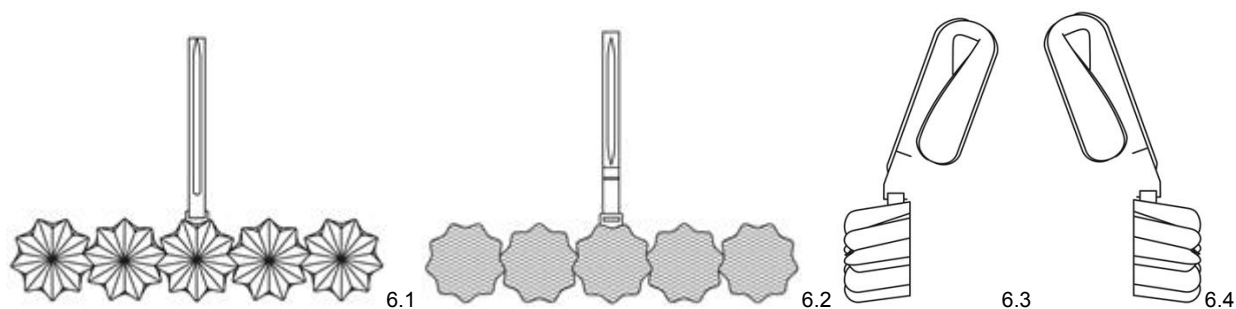

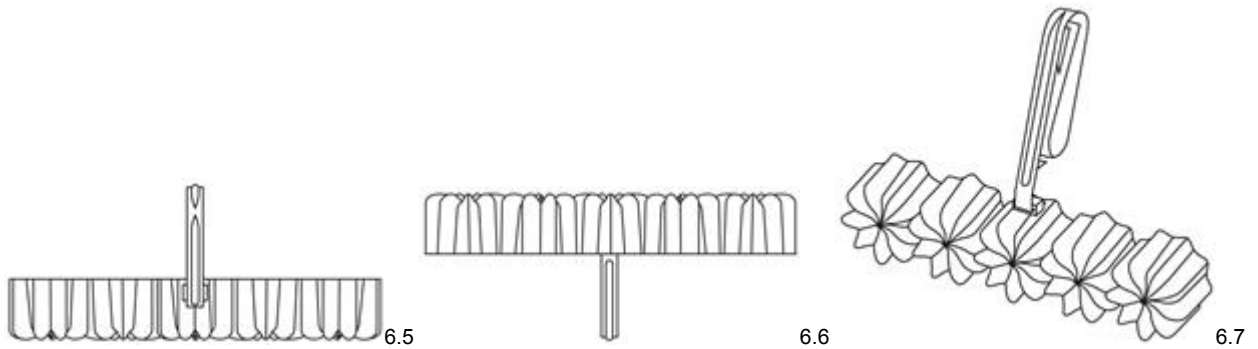
**Design 7**

- (54) **Produkt:** Toilet rim blocks
 (51) **Klasse:** 23-02
 (72) **Designer:** Tomas Müller, Zamecek 443, 50008 HRADEC KRALOVE, Den tsjekkiske republikk (CZ)
 (30) **Prioritet:** 2017.10.02, EM, 004382356, 1, 2, 3, 4, 5, 6, 7, 8, 9, 10, 11, 12
 (50) **Anmerkning:** Designet er i farger.
 (55) **Designavbildninger:**

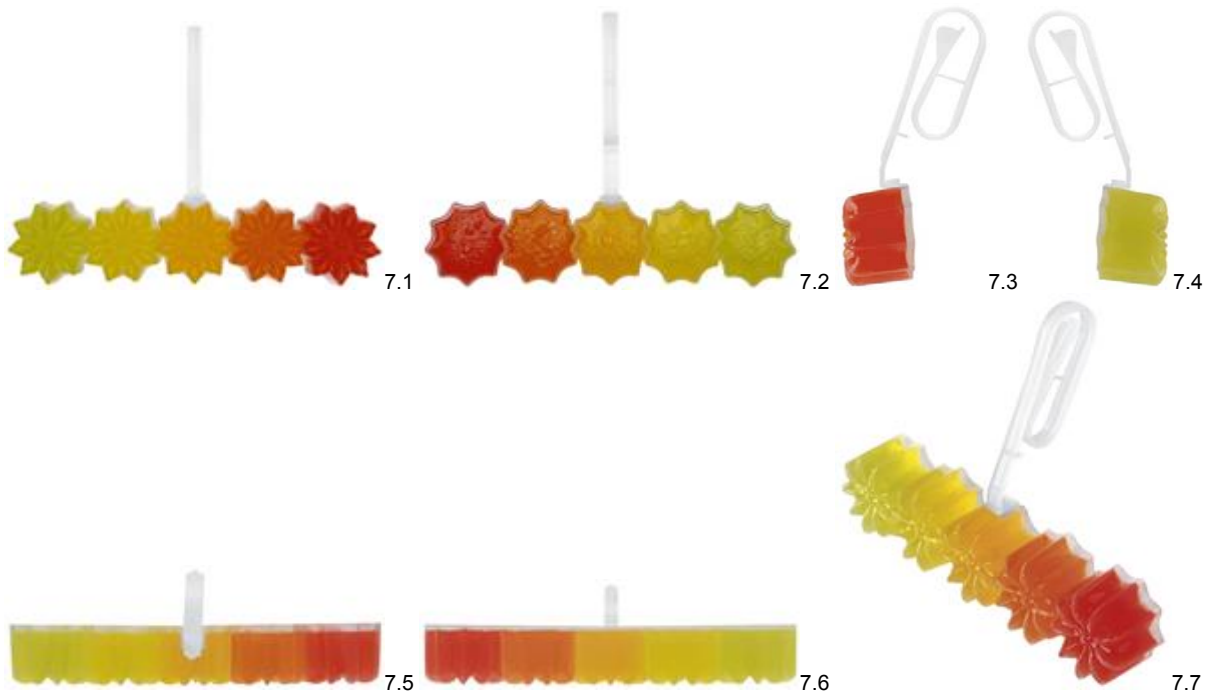
**Design 8**

- (54) **Produkt:** Toilet rim blocks
 (51) **Klasse:** 23-02
 (72) **Designer:** Tomas Müller, Zamecek 443, 50008 HRADEC KRALOVE, Den tsjekkiske republikk (CZ)
 (30) **Prioritet:** 2017.10.02, EM, 004382356, 1, 2, 3, 4, 5, 6, 7, 8, 9, 10, 11, 12
 (50) **Anmerkning:** Designet er i farger.
 (55) **Designavbildninger:**

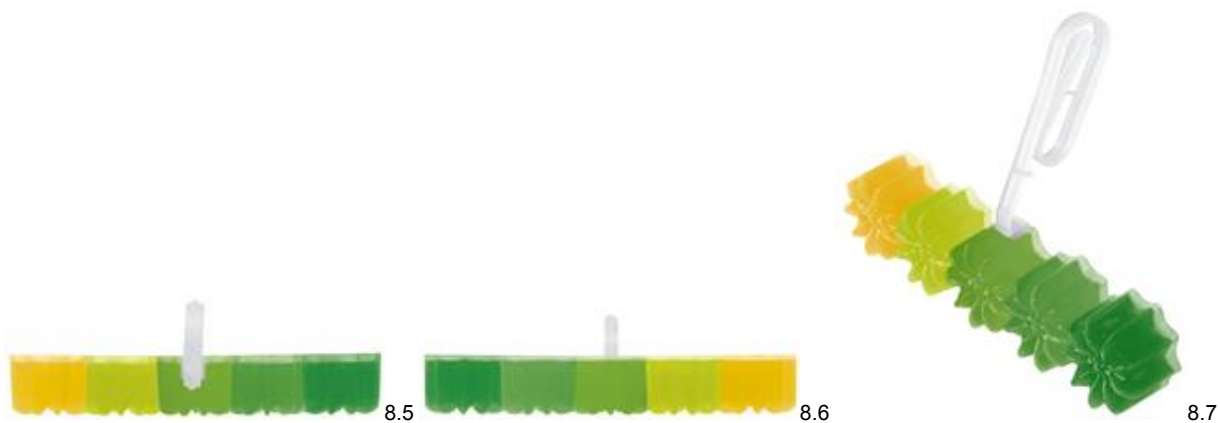

**Design 9**

- (54) **Produkt:** Toilet rim blocks
 (51) **Klasse:** 23-02
 (72) **Designer:** Tomas Müller, Zamecek 443, 50008 HRADEC KRALOVE, Den tsjekkiske republikk (CZ)
 (30) **Prioritet:** 2017.10.02, EM, 004382356, 1, 2, 3, 4, 5, 6, 7, 8, 9, 10, 11, 12
 (50) **Anmerkning:** Designet er i farger.
 (55) **Designavbildninger:**

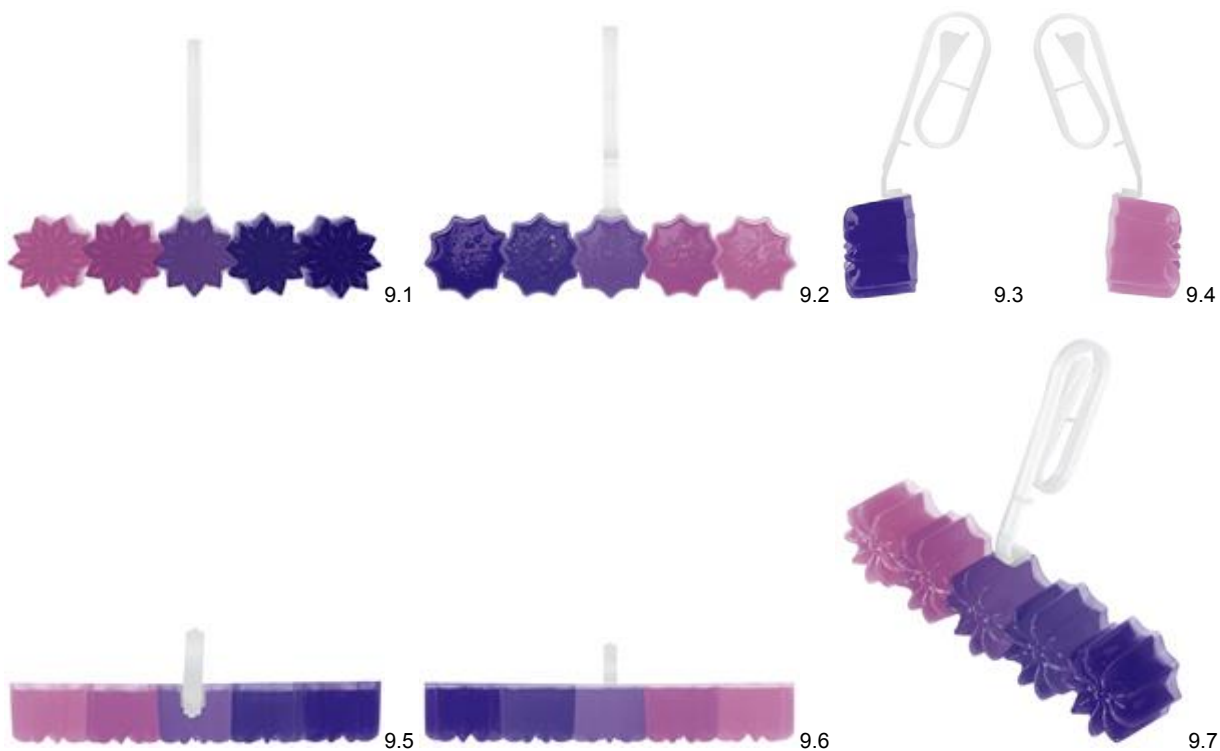
**Design 10**

- (54) **Produkt:** Toilet rim blocks
 (51) **Klasse:** 23-02
 (72) **Designer:** Tomas Müller, Zamecek 443, 50008 HRADEC KRALOVE, Den tsjekkiske republikk (CZ)
 (30) **Prioritet:** 2017.10.02, EM, 004382356, 1, 2, 3, 4, 5, 6, 7, 8, 9, 10, 11, 12
 (50) **Anmerkning:** Designet er i farger.
 (55) **Designavbildninger:**

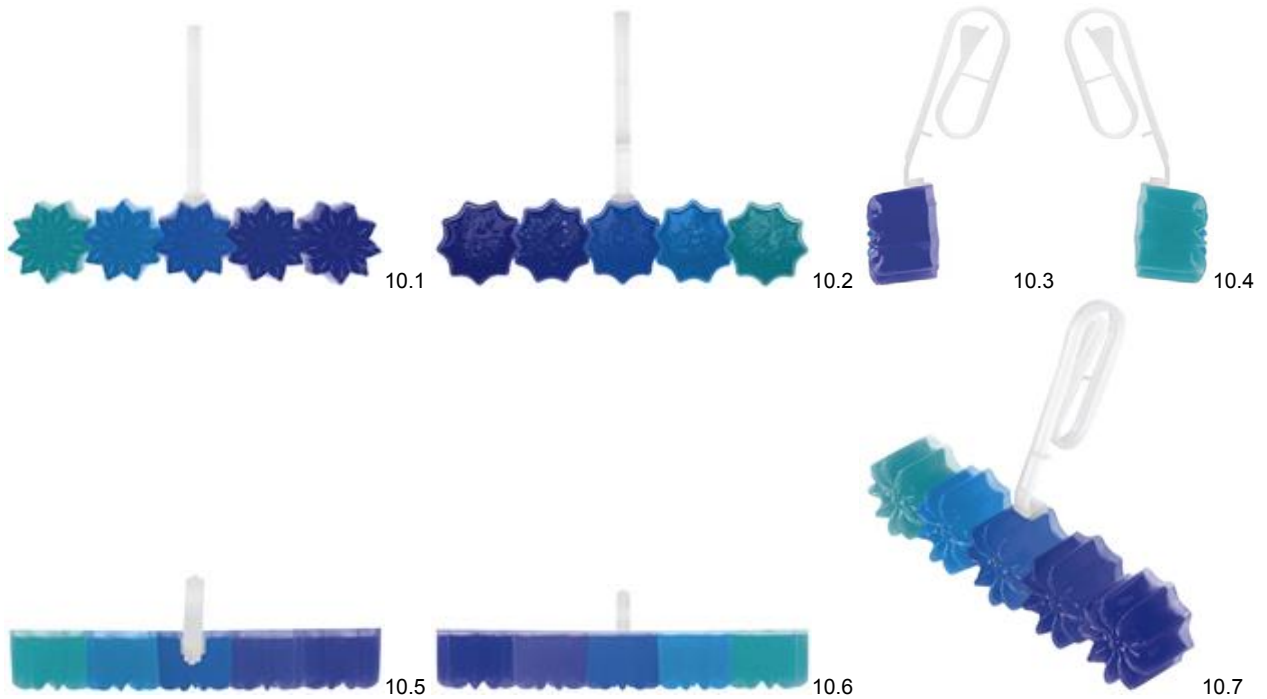
**Design 11**

- (54) **Produkt:** Toilet rim blocks
 (51) **Klasse:** 23-02
 (72) **Designer:** Tomas Müller, Zamecek 443, 50008 HRADEC KRALOVE, Den tsjekkiske republikk (CZ)
 (30) **Prioritet:** 2017.10.02, EM, 004382356, 1, 2, 3, 4, 5, 6, 7, 8, 9, 10, 11, 12
 (50) **Anmerkning:** Designet er i farger.
 (55) **Designavbildninger:**

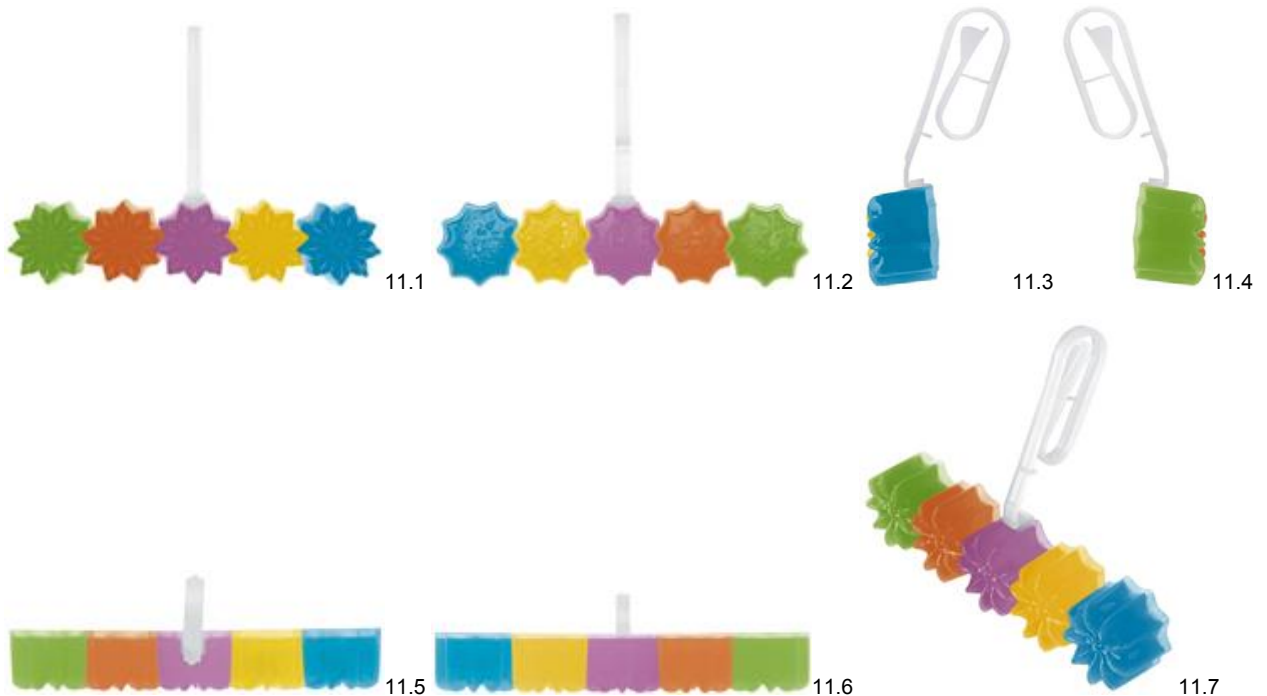
**Design 12**

- (54) **Produkt:** Toilet rim blocks
 (51) **Klasse:** 23-02
 (72) **Designer:** Tomas Müller, Zamecek 443, 50008 HRADEC KRALOVE, Den tsjekkiske republikk (CZ)
 (30) **Prioritet:** 2017.10.02, EM, 004382356, 1, 2, 3, 4, 5, 6, 7, 8, 9, 10, 11, 12
 (55) **Designavbildninger:**



12.1



12.2



12.3

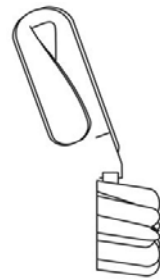

12.4

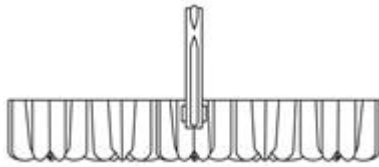

12.5

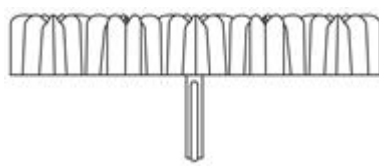

12.6

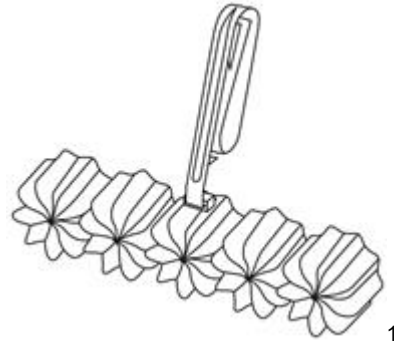

12.7

(11) Reg.nr.:	DM/100968
(21) Søkn.nr.:	20180459
(22) Inngitt i WIPO:	2018.04.25
(15) Registrert i WIPO:	2018.04.25
(24) Løpedag:	2018.04.25
(43) Allm. tilgj.:	2018.05.18
(15) Besluttet gjeldende NO:	2018.06.29
(45) Kunngjort NO:	2018.07.16
(18) Reg. gjelder til:	2023.04.25
(73) Innehaver:	ESCOFET 1886, S.A., C/ Montserrat, 162, ES-08760 MARTORELL, BARCELONA, Spania
(50) Anmerkninger:	Registreringen gjelder samregistrering.

Design 1

(54) Produkt:	Street furniture
(51) Klasse:	06-01
(72) Designer:	Pere Buil Castells, Sant Pere més Alt, 62 entl. bxs., 08003 BARCELONA, Spania (ES) Toni Riba Galí, Sant Pere més Alt, 62 entl. bxs, 08003 BARCELONA, Spania (ES)
(55) Designavbildninger:	

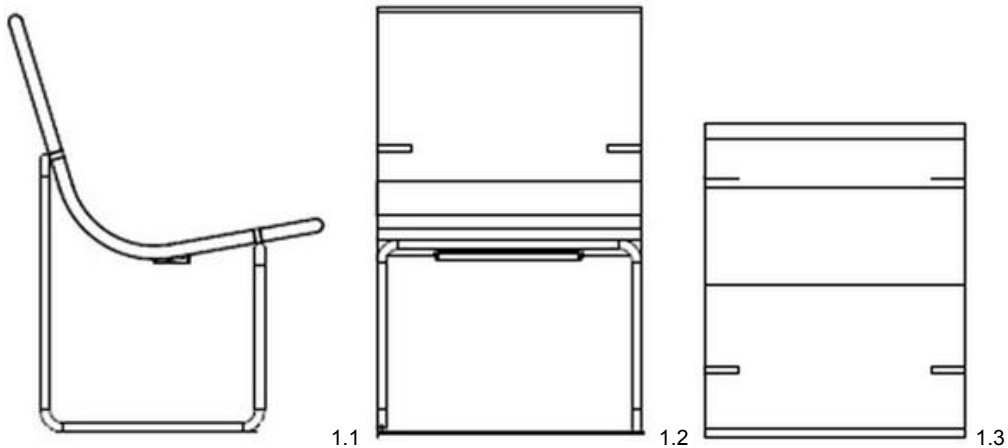
**Design 2**

(54) Produkt:	Street furniture
(51) Klasse:	06-01
(72) Designer:	Pere Buil Castells, Sant Pere més Alt, 62 entl. bxs., 08003 BARCELONA, Spania (ES) Toni Riba Galí, Sant Pere més Alt, 62 entl. bxs, 08003 BARCELONA, Spania (ES)
(55) Designavbildninger:	

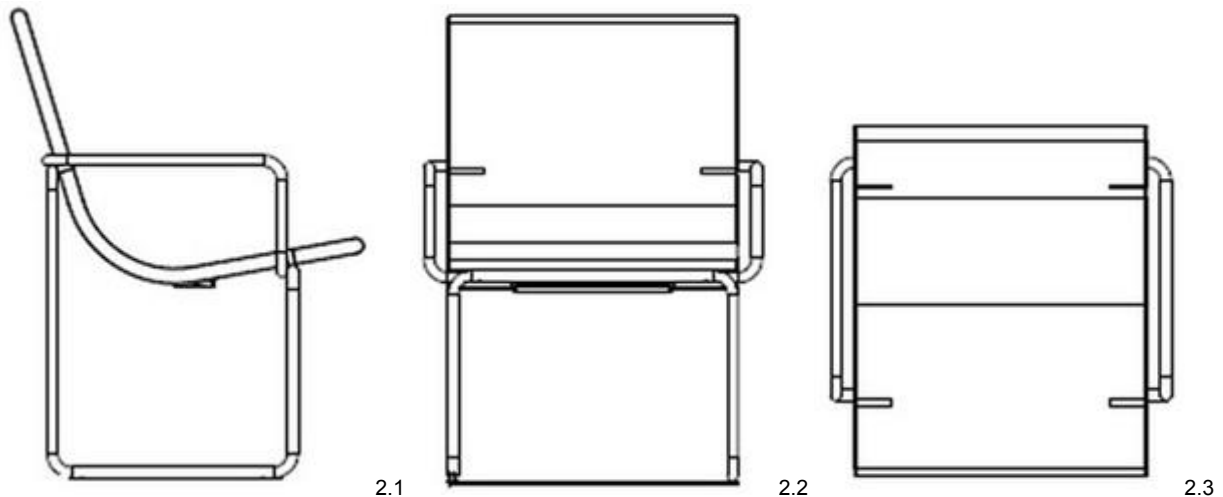

(11)	Reg.nr.:	DM/100969
(21)	Søkn.nr.:	20180460
(22)	Inngitt i WIPO:	2018.04.25
(15)	Registrert i WIPO:	2018.04.25
(24)	Løpedag:	2018.04.25
(43)	Allm. tilgj.:	2018.05.18
(15)	Besluttet gjeldende NO:	2018.06.29
(45)	Kunngjort NO:	2018.07.16
(18)	Reg. gjelder til:	2023.04.25
(73)	Innehaver:	ESCOFET 1886, S.A., C/ Montserrat, 162, ES-08760 MARTORELL, BARCELONA, Spania
(50)	Anmerkninger:	Registreringen gjelder samregistrering.

Design 1

(54)	Produkt:	Street planters
(51)	Klasse:	25-02
(72)	Designer:	Javier Errando Mariscal, C/Pellaires, 30-38, 08019 BARCELONA, Spania (ES)
(55)	Designavbildninger:	

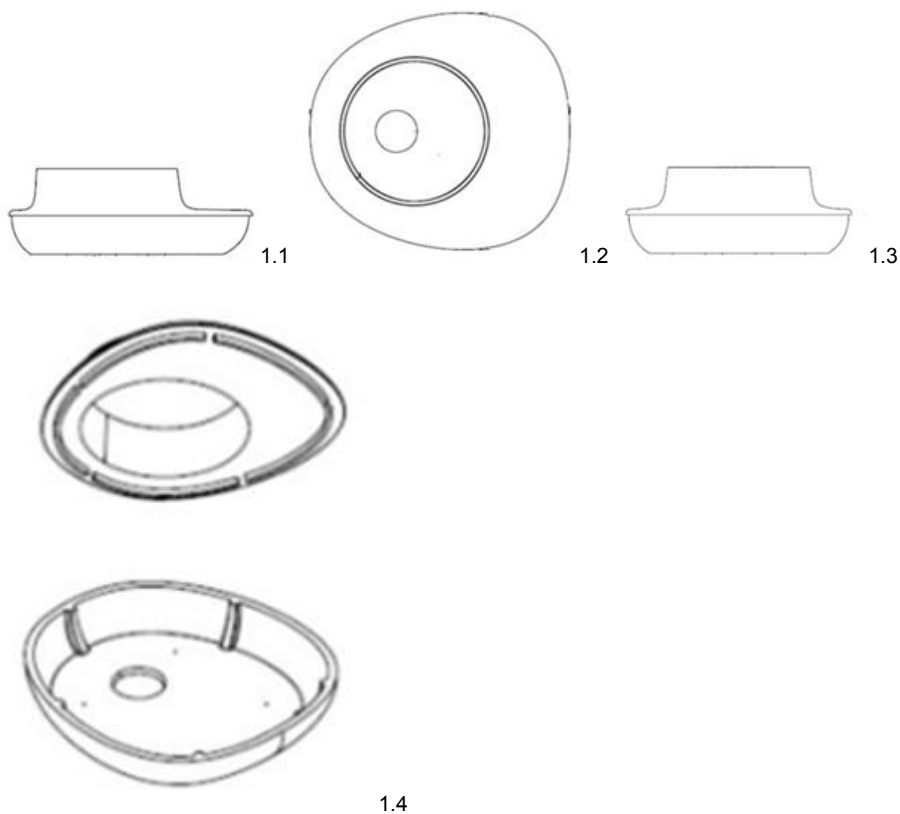
**Design 2**

(54)	Produkt:	Street planters
(51)	Klasse:	25-02
(72)	Designer:	Javier Errando Mariscal, C/Pellaires, 30-38, 08019 BARCELONA, Spania (ES)
(55)	Designavbildninger:	





2.4

Design 3

- (54) **Produkt:** Street planters
(51) **Klasse:** 25-02
(72) **Designer:** Javier Errando Mariscal, C/Pellaires, 30-38, 08019 BARCELONA, Spania (ES)
(55) **Designavbildninger:**



3.1

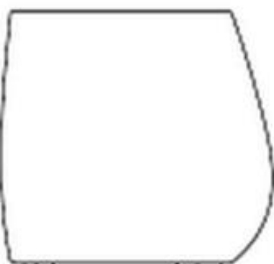

3.2

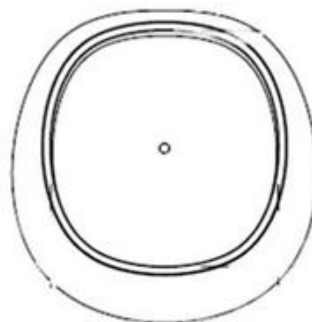

3.3

(11) Reg.nr.:	DM/100975
(21) Søkn.nr.:	20180461
(22) Inngitt i WIPO:	2018.04.27
(15) Registrert i WIPO:	2018.04.27
(24) Løpedag:	2018.04.27
(43) Allm. tilgj.:	2018.05.18
(15) Besluttet gjeldende NO:	2018.06.29
(45) Kunngjort NO:	2018.07.16
(18) Reg. gjelder til:	2023.04.27
(73) Innehaver:	Cédric Fatio, Chemin du Grand-Pré 14, CH-1163 ETOY, Sveits
(50) Anmerkninger:	Registreringen gjelder samregistrering.

Design 1

(54) Produkt:	Wheeled walkers
(51) Klasse:	12-12
(72) Designer:	Cédric Fatio, Chemin du Grand-Pré 14, 1163 ETOY, Sveits (CH)
(55) Designavbildninger:	

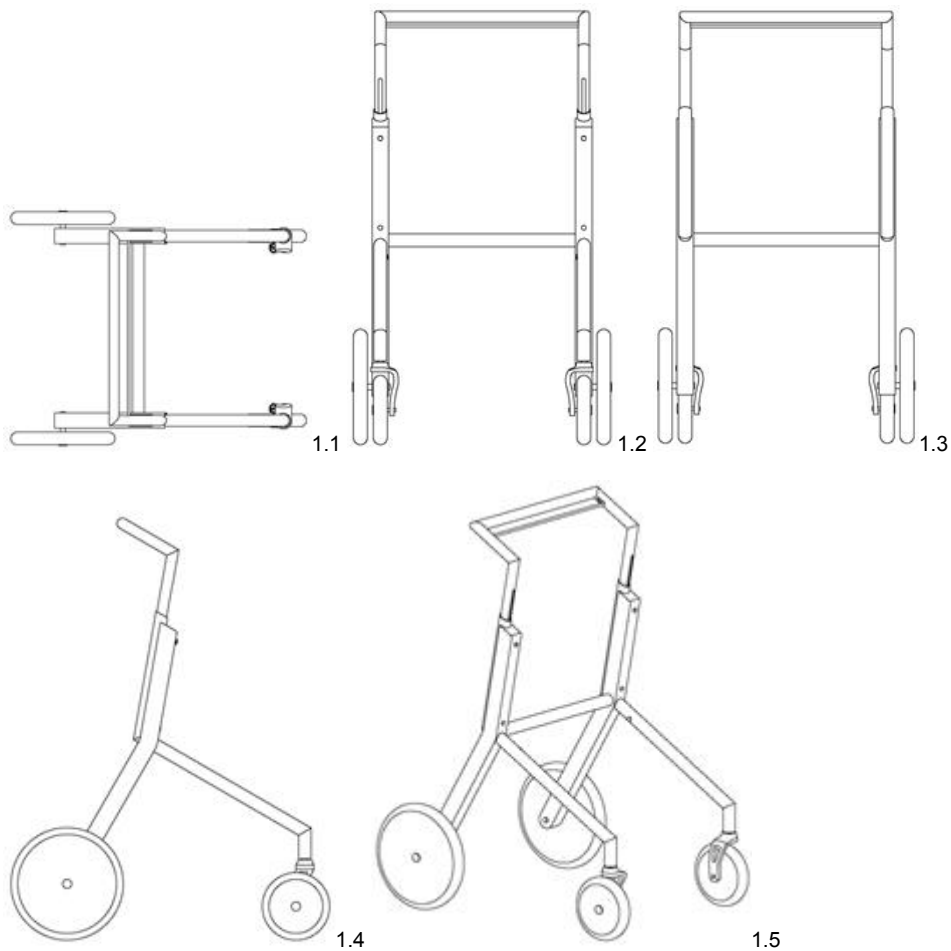

Design 2

- (54) **Produkt:** Wheeled walkers
(51) **Klasse:** 12-12
(72) **Designer:** Cédric Fatio, Chemin du Grand-Pré 14, 1163 ETOY, Sveits (CH)
(55) **Designavbildninger:**

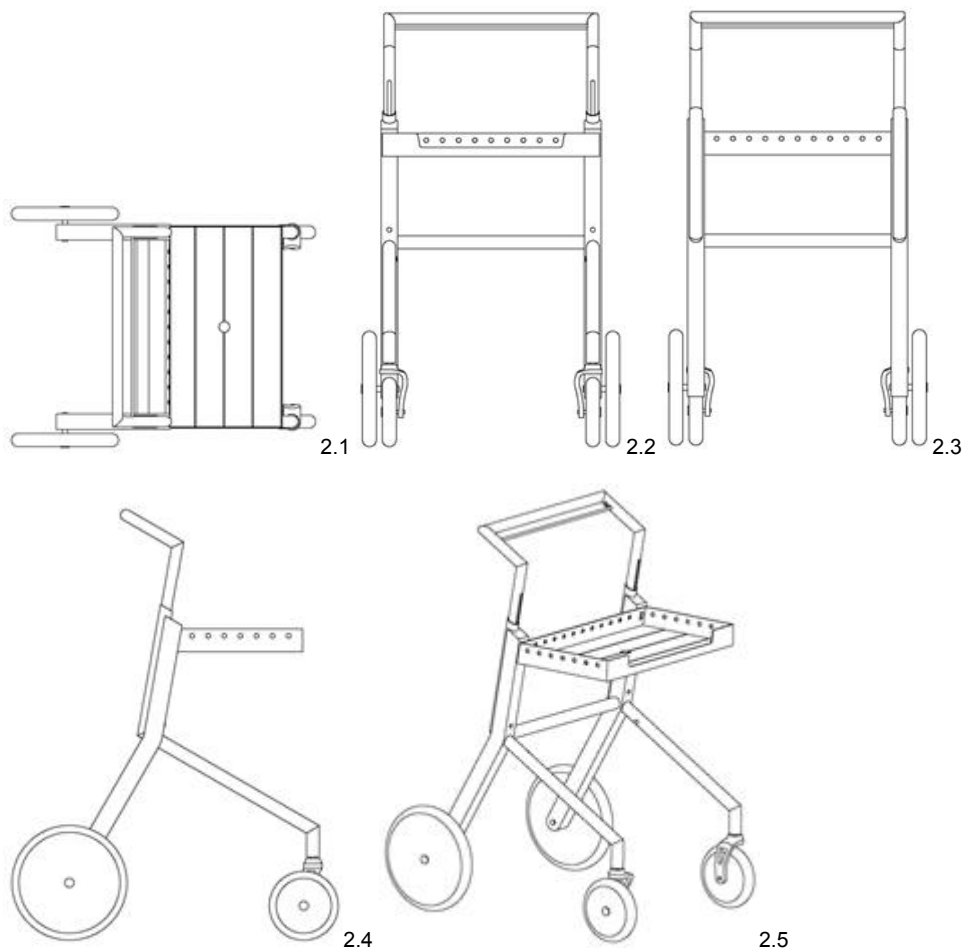
**Design 3**

- (54) **Produkt:** Wheeled walkers
(51) **Klasse:** 12-12
(72) **Designer:** Cédric Fatio, Chemin du Grand-Pré 14, 1163 ETOY, Sveits (CH)
(55) **Designavbildninger:**

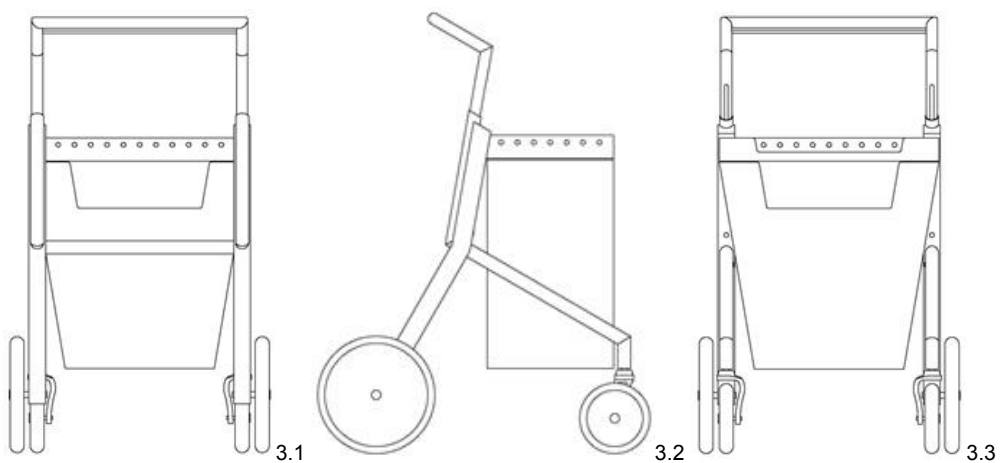



3.4

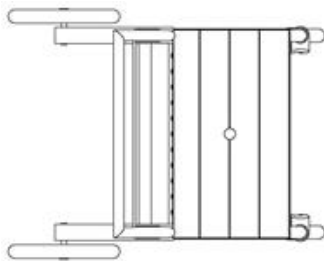

3.5

Design 4

- (54) **Produkt:** Wheeled walkers
- (51) **Klasse:** 12-12
- (72) **Designer:** Cédric Fatio, Chemin du Grand-Pré 14, 1163 ETOY, Sveits (CH)
- (55) **Designavbildninger:**

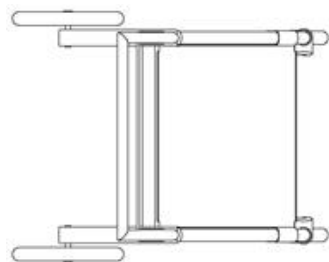

4.1

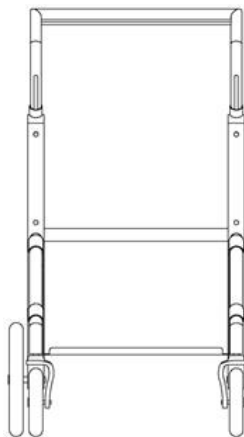

4.2

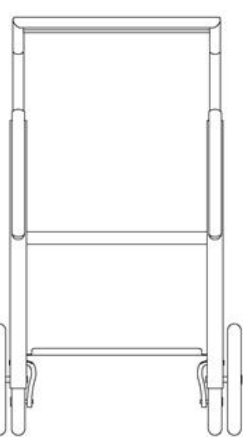

4.3

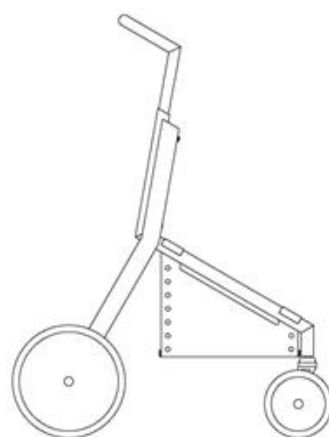

4.4



4.5

Fornyelse av registreringer

(11) **Reg.nr.:** 075065
 (18) **Reg. gjelder til:** 2023.09.09
 (73) **Innehaver:**
 Anchor Wall Systems Inc, 5959 Baker Road, Suite
 390, US-MN55345-5996 MINNETONKA, USA
 (74) **Fullmektig:**
 TANDBERG INNOVATION AS, Postboks 1570 Vika,
 0118 OSLO, Norge

(11) **Reg.nr.:** 075098
 (18) **Reg. gjelder til:** 2023.04.16
 (73) **Innehaver:**
 Ingrid Olsen, Kyrkvegen 43, 6040 VIGRA, Norge

(11) **Reg.nr.:** 077778
 (18) **Reg. gjelder til:** 2023.06.24
 (73) **Innehaver:**
 Sony Kabushiki Kaisha (also trading as Sony
 Corporation), 7-35 Kitashinagawa 6-chome
 Shinagawa-ku, JP-141-0001 TOKYO, Japan
 (74) **Fullmektig:**
 BRYN AARFLOT AS, Stortingsgata 8, 0161 OSLO,
 Norge

(11) **Reg.nr.:** 077937
 (18) **Reg. gjelder til:** 2023.07.03
 (73) **Innehaver:**
 Stokke AS, Hånhjem, 6260 SKODJE, Norge
 (74) **Fullmektig:**
 ZACCO NORWAY AS, Postboks 2003 Vika, 0125
 OSLO, Norge

(11) **Reg.nr.:** 077938
 (18) **Reg. gjelder til:** 2023.07.03
 (73) **Innehaver:**
 Stokke AS, Hånhjem, 6260 SKODJE, Norge
 (74) **Fullmektig:**
 ZACCO NORWAY AS, Postboks 2003 Vika, 0125
 OSLO, Norge

(11) **Reg.nr.:** 078037
 (18) **Reg. gjelder til:** 2023.06.16
 (73) **Innehaver:**
 Unilever NV, Weena 455, NL-3013AL ROTTERDAM,
 Nederland
 (74) **Fullmektig:**
 ZACCO NORWAY AS, Postboks 2003 Vika, 0125
 OSLO, Norge

(11) **Reg.nr.:** 078096
 (18) **Reg. gjelder til:** 2023.09.16
 (73) **Innehaver:**
 Polyform US Ltd, 7030 South 224th, US-WA98032
 KENT, USA
 (74) **Fullmektig:**
 BRYN AARFLOT AS, Stortingsgata 8, 0161 OSLO,
 Norge

(11) **Reg.nr.:** 078291
 (18) **Reg. gjelder til:** 2023.11.06
 (73) **Innehaver:**
 Brødr. Sunde AS, Borgundfjordveien 137, 6022
 ÅLESUND, Norge
 (74) **Fullmektig:**
 ACAPO AS, Postboks 1880 Nordnes, 5817 BERGEN,
 Norge

(11) **Reg.nr.:** 078658
 (18) **Reg. gjelder til:** 2023.08.19
 (73) **Innehaver:**
 Helnor AS, Postboks 10, 2381 BRUMUNDDAL, Norge

(11) **Reg.nr.:** 081097
 (18) **Reg. gjelder til:** 2023.02.25
 (73) **Innehaver:**
 Adax AS, Postboks 38, 3061 SVELVIK, Norge

(11) **Reg.nr.:** 081375
 (18) **Reg. gjelder til:** 2023.06.20
 (73) **Innehaver:**
 Ferrari SpA, Via Emilia Est, 1163, IT-41100 MODENA,
 Italia
 (74) **Fullmektig:**
 OSLO PATENTKONTOR AS, Postboks 7007 M, 0306
 OSLO, Norge

(11) **Reg.nr.:** 081376
 (18) **Reg. gjelder til:** 2023.06.20
 (73) **Innehaver:**
 Ferrari SpA, Via Emilia Est, 1163, IT-41100 MODENA,
 Italia
 (74) **Fullmektig:**
 OSLO PATENTKONTOR AS, Postboks 7007 M, 0306
 OSLO, Norge

(11) **Reg.nr.:** 081377
 (18) **Reg. gjelder til:** 2023.06.18
 (73) **Innehaver:**
 Société de Technologie Michelin, 23, rue Breschet,
 FR-63000 CLERMONT-FERRAND, Frankrike
 Michelin Recherche et Technique SA, Route Louis
 Braille 10-12, CH-1763 GRANGES-PACCOT, Sveits
 (74) **Fullmektig:**
 OSLO PATENTKONTOR AS, Postboks 7007 M, 0306
 OSLO, Norge

(11) **Reg.nr.:** 081399
 (18) **Reg. gjelder til:** 2023.07.09
 (73) **Innehaver:**
 Johnson Controls Technology Co, 915 East 32nd
 Street, US-MI49423 HOLLAND, USA
 (74) **Fullmektig:**
 PROTECTOR INTELLECTUAL PROPERTY
 CONSULTANTS AS, Oscars gate 20, 0352 OSLO,
 Norge

(11) **Reg.nr.:** 081437
(18) **Reg. gjelder til:** 2023.08.06
(73) **Innehaver:**
Arper SpA, Via Lombardia, 16, IT-31050 MONASTIER
DI TREVISO, Italia
(74) **Fullmektig:**
TANDBERG INNOVATION AS, Postboks 1570 Vika,
0118 OSLO, Norge

(11) **Reg.nr.:** 081527
(18) **Reg. gjelder til:** 2023.07.08
(73) **Innehaver:**
Johnson Controls Technology Co, 915 East 32nd
Street, US-MI49423 HOLLAND, USA
(74) **Fullmektig:**
PROTECTOR INTELLECTUAL PROPERTY
CONSULTANTS AS, Oscars gate 20, 0352 OSLO,
Norge

(11) **Reg.nr.:** 081627
(18) **Reg. gjelder til:** 2023.06.27
(73) **Innehaver:**
Panasonic Corp, 1006, Oaza Kadoma, JP-571-8501
KADOMA-SHI, OSAKA, Japan
(74) **Fullmektig:**
BRYN AARFLOT AS, Stortingsgata 8, 0161 OSLO,
Norge

(11) **Reg.nr.:** 081662
(18) **Reg. gjelder til:** 2023.09.17
(73) **Innehaver:**
Buddy Electric AS, Økern Torgvei 1, 0580 OSLO,
Norge
(74) **Fullmektig:**
ONSAGERS AS, Postboks 1813, Vika, 0123 OSLO,
Norge

(11) **Reg.nr.:** 081682
(18) **Reg. gjelder til:** 2023.08.14
(73) **Innehaver:**
Lilleborg AS, Postboks 673 Skøyen, 0214 OSLO,
Norge
(74) **Fullmektig:**
PROTECTOR INTELLECTUAL PROPERTY
CONSULTANTS AS, Oscars gate 20, 0352 OSLO,
Norge

(11) **Reg.nr.:** 081779
(18) **Reg. gjelder til:** 2023.10.31
(73) **Innehaver:**
LMG Marin AS, Postboks 2424 Solheimsviken, 5824
BERGEN, Norge
(74) **Fullmektig:**
ACAPO AS, Postboks 1880 Nordnes, 5817 BERGEN,
Norge

(11) **Reg.nr.:** 084049
(18) **Reg. gjelder til:** 2023.06.19
(73) **Innehaver:**
SYSTEM 2000 GROUP LTD, 39/41 Wood End
Lane Erdington, GB-B248AN BIRMINGHAM,
Storbritannia
(74) **Fullmektig:**
PROTECTOR INTELLECTUAL PROPERTY
CONSULTANTS AS, Oscars gate 20, 0352 OSLO,
Norge

(11) **Reg.nr.:** 084053
(18) **Reg. gjelder til:** 2023.06.17
(73) **Innehaver:**
Compagnie Generale des Etablissements Michelin, 12
cours Sablon, FR-63000 CLERMONT-FERRAND,
Frankrike
Michelin Recherche et Technique SA, Route Louis-
Braille 10, CH-1763 GRANGES-PACCOT, Sveits
(74) **Fullmektig:**
OSLO PATENTKONTOR AS, Postboks 7007 M, 0306
OSLO, Norge

(11) **Reg.nr.:** 084066
(18) **Reg. gjelder til:** 2023.07.02
(73) **Innehaver:**
Apple Inc., 1 Infinite Loop, US-CA95014 CUPERTINO,
USA
(74) **Fullmektig:**
PROTECTOR INTELLECTUAL PROPERTY
CONSULTANTS AS, Oscars gate 20, 0352 OSLO,
Norge

(11) **Reg.nr.:** 084067
(18) **Reg. gjelder til:** 2023.07.02
(73) **Innehaver:**
Apple Inc., 1 Infinite Loop, US-CA95014 CUPERTINO,
USA
(74) **Fullmektig:**
PROTECTOR INTELLECTUAL PROPERTY
CONSULTANTS AS, Oscars gate 20, 0352 OSLO,
Norge

(11) **Reg.nr.:** 084069
(18) **Reg. gjelder til:** 2023.07.02
(73) **Innehaver:**
Ascensia Diabetes Care Holdings AG, Peter Merian-
Str. 90, CH-4052 BASEL, Sveits
(74) **Fullmektig:**
TANDBERG INNOVATION AS, Postboks 1570 Vika,
0118 OSLO, Norge

(11) **Reg.nr.:** 084079
(18) **Reg. gjelder til:** 2023.07.23
(73) **Innehaver:**
The Coca-Cola Company, One Coca-Cola Plaza, US-
GA30313 ATLANTA, USA
(74) **Fullmektig:**
BRYN AARFLOT AS, Stortingsgata 8, 0161 OSLO,
Norge

(11) **Reg.nr.:** 084181
(18) **Reg. gjelder til:** 2023.10.15
(73) **Innehaver:**
Arne Paulsen, Balders Hage 63, 7045 TRONDHEIM,
Norge
(74) **Fullmektig:**
CURO AS, Vestre Rosten 81, 7075 TILLER, Norge

(11) **Reg.nr.:** 084190
(18) **Reg. gjelder til:** 2023.06.21
(73) **Innehaver:**
Geir Morten Olsen, Solvollveien 3, 8206 FAUSKE,
Norge
(74) **Fullmektig:**
ONSAGERS AS, Postboks 1813, Vika, 0123 OSLO,
Norge

(11) **Reg.nr.:** 084281
(18) **Reg. gjelder til:** 2023.07.02
(73) **Innehaver:**
Apple Inc., 1 Infinite Loop, US-CA95014 CUPERTINO,
USA
(74) **Fullmektig:**
PROTECTOR INTELLECTUAL PROPERTY
CONSULTANTS AS, Oscars gate 20, 0352 OSLO,
Norge

(11) **Reg.nr.:** DM/081033
(18) **Reg. gjelder til:** 2018.06.05
(73) **Innehaver:**
Hansgrohe SE, Auestrasse 5-9, DE-77761
SCHILTACH, Tyskland

(11) **Reg.nr.:** DM/081094
(18) **Reg. gjelder til:** 2018.06.07
(73) **Innehaver:**
Ferrari SpA, Via Emilia Est, 1163, IT-41100 MODENA,
Italia

(11) **Reg.nr.:** DM/081095
(18) **Reg. gjelder til:** 2018.06.07
(73) **Innehaver:**
Ferrari SpA, Via Emilia Est, 1163, IT-41100 MODENA,
Italia

(11) **Reg.nr.:** DM/081117
(18) **Reg. gjelder til:** 2018.06.04
(73) **Innehaver:**
Volvo Truck Corporation, SE-40508 GÖTEBORG,
Sverige

(11) **Reg.nr.:** DM/081122
(18) **Reg. gjelder til:** 2018.06.05
(73) **Innehaver:**
Marimekko OYJ, Puusepänkatu 4, FI-00880
HELSINGFORS, Finland

(11) **Reg.nr.:** DM/081163
(18) **Reg. gjelder til:** 2018.06.04
(73) **Innehaver:**
Volvo Truck Corporation, SE-40508 GÖTEBORG,
Sverige

(11) **Reg.nr.:** DM/081169
(18) **Reg. gjelder til:** 2018.06.12
(73) **Innehaver:**
Mascot International A/S, Julsøvej 100, DK-8600
SILKEBORG, Danmark
(74) **Fullmektig:**
Bech-Bruun Law Firm, Værkmestergade 2, DK-8000
AARHUS C, Danmark

(11) **Reg.nr.:** DM/081171
(18) **Reg. gjelder til:** 2018.06.12
(73) **Innehaver:**
Mascot International A/S, Julsøvej 100, DK-8600
SILKEBORG, Danmark
(74) **Fullmektig:**
Bech-Bruun Law Firm, Værkmestergade 2, DK-8000
AARHUS C, Danmark

(11) **Reg.nr.:** DM/081184
(18) **Reg. gjelder til:** 2018.06.13
(73) **Innehaver:**
Óttar Ólafsson, Hrauntungu 51, IS-200 KÓPAVOGI,
Island

(11) **Reg.nr.:** DM/081222
(18) **Reg. gjelder til:** 2018.06.04
(73) **Innehaver:**
Volvo Truck Corporation, SE-40508 GÖTEBORG,
Sverige

(11) **Reg.nr.:** DM/081223
(18) **Reg. gjelder til:** 2018.06.04
(73) **Innehaver:**
Volvo Truck Corporation, SE-40508 GÖTEBORG,
Sverige

(11) **Reg.nr.:** DM/081224
(18) **Reg. gjelder til:** 2018.06.04
(73) **Innehaver:**
Volvo Truck Corporation, SE-40508 GÖTEBORG,
Sverige

(11) **Reg.nr.:** DM/081238
(18) **Reg. gjelder til:** 2018.06.14
(73) **Innehaver:**
NMC S.A., Gert-Noël-Strasse, BE-4731 EYNATTEN,
Belgia

(11) **Reg.nr.:** DM/081379
(18) **Reg. gjelder til:** 2018.06.14
(73) **Innehaver:**
Novartis AG, CH-4002 BASEL, Sveits

(11) **Reg.nr.:** DM/081457
(18) **Reg. gjelder til:** 2018.06.11
(73) **Innehaver:**
Intersnack Group GmbH & Co. KG, Peter-Müller-
Strasse 3, DE-40468 DÜSSELDORF, Tyskland

(11) **Reg.nr.:** DM/081517
(18) **Reg. gjelder til:** 2018.08.12
(73) **Innehaver:**
Fackelmann GmbH + Co KG, Sebastian-Fackelmann-
Straße 6, DE-91217 HERSBRUCK, Tyskland

(11) **Reg.nr.:** DM/081982
(18) **Reg. gjelder til:** 2018.08.22
(73) **Innehaver:**
Rosti Mepal Support B.V., Aalsvoort 101, NL-7241MB
LOCHEM, Nederland

(11) **Reg.nr.:** DM/082137
(18) **Reg. gjelder til:** 2018.08.20
(73) **Innehaver:**
The Absolut Company AB, SE-11797 STOCKHOLM,
Sverige

(11) **Reg.nr.:** DM/082141
(18) **Reg. gjelder til:** 2018.09.12
(73) **Innehaver:**
The Absolut Company AB, SE-11797 STOCKHOLM,
Sverige

Endringer i fullmaktsforhold

- (21) **Søknadsnr.** 20180514
(71) **Søker:**
LEVE HYTTER AS, Granrudvegen 6, 2636 ØYER,
Norge
(74) **Fullmektig:**
ONSAGERS AS, Postboks 1813, Vika, 0123 OSLO,
Norge
Melding innkommet patentstyret:
2018.06.18
-

- (11) **Reg.nr.:** DM/100289
(73) **Innehaver:**
FRANZ NEUHOFER JUN, Haslau 56, AT-4893 ZELL
AM MOOS, Østerrike
(74) **Fullmektig:**
TANDBERG INNOVATION AS, Postboks 1570 Vika,
0118 OSLO, Norge
Melding innkommet patentstyret:
2018.06.20
-

Slettede, utgåtte og opphørte nasjonale designregistreringer

(11)	Reg.nr.:	074300	(11)	Reg.nr.:	083892
(11)	Reg.nr.:	074478	(11)	Reg.nr.:	083895
(11)	Reg.nr.:	074890	(11)	Reg.nr.:	083896
(11)	Reg.nr.:	074907	(11)	Reg.nr.:	083899
(11)	Reg.nr.:	074992	(11)	Reg.nr.:	083901
(11)	Reg.nr.:	075392A	(11)	Reg.nr.:	083906
(11)	Reg.nr.:	077439	(11)	Reg.nr.:	083919
(11)	Reg.nr.:	077440	(11)	Reg.nr.:	083930
(11)	Reg.nr.:	077687	(11)	Reg.nr.:	083946
(11)	Reg.nr.:	077874			
(11)	Reg.nr.:	078432			
(11)	Reg.nr.:	078433			
(11)	Reg.nr.:	078434			
(11)	Reg.nr.:	078435			
(11)	Reg.nr.:	080945			
(11)	Reg.nr.:	080948			
(11)	Reg.nr.:	080966			
(11)	Reg.nr.:	080991			
(11)	Reg.nr.:	081019			
(11)	Reg.nr.:	081196			
(11)	Reg.nr.:	083766			
(11)	Reg.nr.:	083771			
(11)	Reg.nr.:	083794			
(11)	Reg.nr.:	083795			
(11)	Reg.nr.:	083799			
(11)	Reg.nr.:	083816			
(11)	Reg.nr.:	083820			
(11)	Reg.nr.:	083821			
(11)	Reg.nr.:	083836			
(11)	Reg.nr.:	083837			
(11)	Reg.nr.:	083838			
(11)	Reg.nr.:	083840			
(11)	Reg.nr.:	083848			
(11)	Reg.nr.:	083851			
(11)	Reg.nr.:	083870			
(11)	Reg.nr.:	083874			
(11)	Reg.nr.:	083891			

Slettede, utgåtte og opphørte internasjonale designregistreringer

(11) **Reg.nr.:** DM/079576
 (73) **Innehaver:**
 Rosenbauer International AG, Paschinger Strasse 90,
 AT-4060 LEONDING, Østerrike
 (75) **Adresse for korrespondanse:**
 Anwälte Burger und Partner Rechtsanwalt GmbH,
 Rosenauerweg 16, 4580 WINDISCHGARSTEN,
 Austria (AT)

(11) **Reg.nr.:** DM/079578
 (73) **Innehaver:**
 Rosenbauer International AG, Paschinger Strasse 90,
 AT-4060 LEONDING, Østerrike
 (75) **Adresse for korrespondanse:**
 Anwälte Burger und Partner Rechtsanwalt GmbH,
 Rosenauerweg 16, 4580 WINDISCHGARSTEN,
 Austria (AT)

(11) **Reg.nr.:** DM/079602
 (73) **Innehaver:**
 The Swatch Group Management Services AG (The
 Swatch Group Management Services SA) (The
 Swatch Group Management Services Ltd),
 Seevorstadt 6, CH-2502 BIEL/BIENNE, Sveits
 (75) **Adresse for korrespondanse:**
 The Swatch Group SA (The Swatch Group AG) (The
 Swatch Group Ltd) Service des Marques, Faubourg du
 Lac 6, 2501 BIEL/BIENNE, Switzerland (CH)

(11) **Reg.nr.:** DM/079611
 (73) **Innehaver:**
 Swatch AG (Swatch SA) (Swatch Ltd), Jakob-Stämpfli-
 Strasse 94, CH-2502 BIEL/BIENNE, Sveits
 (75) **Adresse for korrespondanse:**
 The Swatch Group SA (The Swatch Group AG) (The
 Swatch Group Ltd), 6, Faubourg du Lac, 2501
 BIEL/BIENNE, Switzerland (CH)

(11) **Reg.nr.:** DM/079612
 (73) **Innehaver:**
 Swatch AG (Swatch SA) (Swatch Ltd), Jakob-Stämpfli-
 Strasse 94, CH-2502 BIEL/BIENNE, Sveits
 (75) **Adresse for korrespondanse:**
 The Swatch Group SA (The Swatch Group AG) (The
 Swatch Group Ltd), 6, Faubourg du Lac, 2501
 BIEL/BIENNE, Switzerland (CH)

(11) **Reg.nr.:** DM/079613
 (73) **Innehaver:**
 Swatch AG (Swatch SA) (Swatch Ltd), Jakob-Stämpfli-
 Strasse 94, CH-2502 BIEL/BIENNE, Sveits
 (75) **Adresse for korrespondanse:**
 The Swatch Group SA (The Swatch Group AG) (The
 Swatch Group Ltd), 6, Faubourg du Lac, 2501
 BIEL/BIENNE, Switzerland (CH)

(11) **Reg.nr.:** DM/079621
 (73) **Innehaver:**
 Thomas Sabo GmbH & Co. KG, Silberstrasse 1, DE-
 91207 LAUF A. D. PEGNITZ, Tyskland
 (75) **Adresse for korrespondanse:**
 Thomas Sabo GmbH & Co. KG, Silberstrasse 1,
 91207 LAUF A. D. PEGNITZ, Germany (DE)

(11) **Reg.nr.:** DM/079639
 (73) **Innehaver:**
 Landmann Holding GmbH & Co KG, Am Binnenfeld 3-
 5, DE-27711 OSTERHOLZ-SCHARMBECK, Tyskland
 (75) **Adresse for korrespondanse:**
 Meissner, Bolte & Partner GbR, Hollerallee 73, 28209
 BREMEN, Germany (DE)

(11) **Reg.nr.:** DM/079662
 (73) **Innehaver:**
 Tod's S.p.A., Via Filippo Della Valle, 1, IT-63811
 SANT'ELPIDIO A MARE (FM), Italia
 (75) **Adresse for korrespondanse:**
 Jacobacci & Partners S.p.A., Corso Emilia, 8, 10152
 TORINO, Italy (IT)

(11) **Reg.nr.:** DM/079663
 (73) **Innehaver:**
 ETA SA Manufacture Horlogère Suisse, CH-2540
 GRENCHEN, Sveits
 (75) **Adresse for korrespondanse:**
 The Swatch Group SA (The Swatch Group AG) (The
 Swatch Group Ltd), Faubourg du Lac 6, 2502
 BIEL/BIENNE, Switzerland (CH)

(11) **Reg.nr.:** DM/079670
 (73) **Innehaver:**
 Vladka Sturesson, Riddargatan 48, SE-11457
 STOCKHOLM, Sverige
 (75) **Adresse for korrespondanse:**
 Vladka Sturesson, Riddargatan 48, 11457
 STOCKHOLM, Sweden (SE)

(11) **Reg.nr.:** DM/079699
 (73) **Innehaver:**
 Leiffheit AG, Leiffheitstrasse, DE-56377
 NASSAU/LAHN, Tyskland
 (75) **Adresse for korrespondanse:**
 CMS Hasche Sigle, Kranhaus 1, Im Zollhafen 18,
 50678 KÖLN, Germany (DE)

(11) **Reg.nr.:** DM/079839
 (73) **Innehaver:**
 Ivar Frischer, Karl Gustavsgatan 31 lgh 1402, SE-
 41125 GÖTEBORG, Sverige###Markus Hallberg,
 Bukärrsvägen 1, SE-42941 SÄRÖ, Sverige###Fredrik
 Lotto, Ättehögsgatan 7F, SE-41674 GÖTEBORG,
 Sverige###Jon Holmdahl, Övre Djupedahlsgatan 11B,
 SE-41307 GÖTEBORG, Sverige###Matias Cindric,
 Stensjöberg 17, SE-43136 MÖLNDAL,
 Sverige###Tina Thörner, Unterdorfstrasse 3, CH-8269
 FRUTWILEN, Sveits
 (75) **Adresse for korrespondanse:**
 Ivar Frischer, Karl Gustavsgatan 31 lgh 1402, 41125
 GÖTEBORG, Sweden (SE)

(11) **Reg.nr.:** DM/080299
 (73) **Innehaver:**
 Swissvoice SA, Chemin des Mûriers 1, CH-1170
 AUBONNE, Sveits
 (75) **Adresse for korrespondanse:**
 Peter Rutz, c/o Rutz & Partner, Case postale 4627,
 6304 ZUG, Switzerland (CH)

- (11) **Reg.nr.:** DM/080388
(73) **Innehaver:**
Rafet Eren Yorulmazer, Askerocagi Caddesi No:15
Suzer Plaza Kat:30/31 Sisli, TR-ISTANBUL, Tyrkia
(75) **Adresse for korrespondanse:**
Adres Patent Marka Fikri Haklari Danismanlik Ticaret
Limited Sirketi, Büyükdere Cad. N. 62 Lale Ishani Kat:
1, Mecidiyekoy - Sisli, 34387 ISTANBUL, Turkey (TR)
-

- (11) **Reg.nr.:** DM/080599
(73) **Innehaver:**
Koziol Ideas for Friends GmbH, Werner-von-Siemens-
Straße 90, DE-64711 ERBACH, Tyskland
(75) **Adresse for korrespondanse:**
Hans-Joachim Chambosse, Savignystraße 71, 60325
FRANKFURT/MAIN, Germany (DE)
-

- (11) **Reg.nr.:** DM/080600
(73) **Innehaver:**
Koziol Ideas for Friends GmbH, Werner-von-Siemens-
Straße 90, DE-64711 ERBACH, Tyskland
(75) **Adresse for korrespondanse:**
Hans-Joachim Chambosse, Savignystraße 71, 60325
FRANKFURT/MAIN, Germany (DE)
-

- (11) **Reg.nr.:** DM/080601
(73) **Innehaver:**
Koziol Ideas for Friends GmbH, Werner-von-Siemens-
Straße 90, DE-64711 ERBACH, Tyskland
(75) **Adresse for korrespondanse:**
Hans-Joachim Chambosse, Savignystraße 71, 60325
FRANKFURT/MAIN, Germany (DE)
-

- (11) **Reg.nr.:** DM/080602
(73) **Innehaver:**
Koziol Ideas for Friends GmbH, Werner-von-Siemens-
Straße 90, DE-64711 ERBACH, Tyskland
(75) **Adresse for korrespondanse:**
Hans-Joachim Chambosse, Savignystraße 71, 60325
FRANKFURT/MAIN, Germany (DE)
-

- (11) **Reg.nr.:** DM/081021
(73) **Innehaver:**
Rafet Eren Yorulmazer, Askerocagi Caddesi No:15
Suzer Plaza Kat:30/31 Sisli, TR-ISTANBUL, Tyrkia
(75) **Adresse for korrespondanse:**
Adres Patent Marka Fikri Haklari Danismanlik Ticaret
Limited Sirketi, Büyükdere Cad. N. 62 Lale Ishani Kat:
1, Mecidiyekoy - Sisli, 34387 ISTANBUL, Turkey (TR)
-