

Norsk

design tidende

www.patentstyret.no

Norsk designtidende er en publikasjon som inneholder kunngjøringer innenfor designområdet

BESØKSADRESSE

- ▶ Sandakerveien 64

POSTADRESSE

- ▶ Postboks 8160 Dep.
0033 Oslo

E-POST

- ▶ mail@patentstyret.no

TELEFON

- ▶ 22 38 73 00

TELEFAKS

- ▶ 22 38 73 01

INFOSENTERETS TELEFONTID

- ▶ kl. 09.00 - 15.00
Telefon (+47) 22 38 73 33
Telefaks (+47) 22 38 73 31

Innholdsfortegnelse:

Registrerte design	3
Internasjonale designregistreringer	59
Overdragelser	133
Fornyelse av registreringer	134

INID-koder

I kunngjøringene er de enkelte data forsynt med koder overensstemmende med INID-kodesystemet

(INID= Internationally agreed Numbers for the Identification of Data).

- (11) Registreringsnummer
- (15) Registreringsdato
- (18) Dato som registreringen gjelder til
- (21) Søknadsnummer
- (22) Inngivelsesdato
- (24) Løpedag
- (30) Prioritetsopplysninger
- (43) Allment tilgjengelig dato
- (51) Klasse
- (54) Produkt
- (55) Avbildning(er)
- (72) Designer
- (73) Innehaver
- (74) Fullmektig

Registrerte design

I henhold til designloven § 18 første ledd i.f. kunngjøres i dag følgende registrerte design.

Det kan fremsettes krav om at designregistreringen helt eller delvis skal oppheves, jf. designloven §§ 25 flg. og designforskriften §§ 26 flg.

Designregistreringen gjelder for den eller de periodene på fem år som søknaden er innlevert for, regnet fra søknadsdagen. Registreringen kan fornyes, jf. designloven §§ 23 og 24. Maksimal beskyttelsestid er 25 år. For reservedeler, se unntaket i designloven § 23 annet ledd.

(11)	Reg.nr.:	083982
(21)	Søkn.nr.:	20130325
(22)	Inngitt:	2013.03.22
(24)	Løpedag:	2013.03.22
(43)	Allm. tilgj.:	2013.03.22
(15)	Registrert:	2013.06.10
(45)	Kunngjort:	2013.07.08
(18)	Reg. gjelder til:	2018.03.22
(74)	Fullmektig:	Acapo AS, Postboks 1880 Nordnes, 5817 BERGEN, Norge
(73)	Innehaver:	Penny & Giles Controls Ltd, 15 Airfield Road, GB-BH233TG CHRISTCHURCH, DORSET, Storbritannia

Design 1

(54)	Produkt:	Joystick-modul for rullestol
(51)	Klasse:	12-16
(72)	Designer:	Charles Downs, 112 Leigh Road, BH212AE WIMBORNE, Storbritannia (GB)
(30)	Prioritet:	2012.09.25, GB, 4026475
(55)	Designavbildninger:	

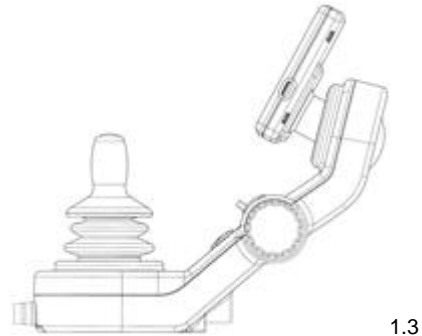
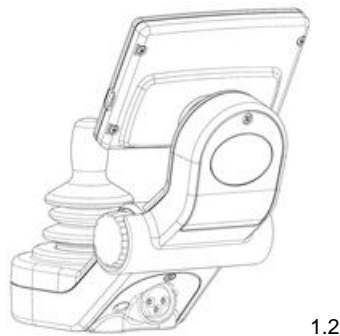

(11)	Reg.nr.:	083983
(21)	Søkn.nr.:	20121036
(22)	Inngitt:	2012.12.03
(24)	Løpedag:	2012.12.03
(43)	Allm. tilgj.:	2012.12.03
(15)	Registrert:	2013.06.10
(45)	Kunngjort:	2013.07.08
(18)	Reg. gjelder til:	2017.12.03
(74)	Fullmektig:	Bull & Co Advokatfirma AS, Postboks 2583 Solli, 0203 OSLO, Norge
(73)	Innehaver:	Jan Erik Arentz, Tord Pedersensgt 46, 3014 DRAMMEN, Norge Wilhelm Atle Wilhelmsen, Tord Pedersens gt 83 A, 3014 DRAMMEN, Norge

Design 1

(54)	Produkt:	Alpinskistativ for montering på vegg/tak
(51)	Klasse:	08-08
(72)	Designert:	Jan Erik Arentz, Tord Pedersensgt 46, 3014 DRAMMEN Wilhelm Atle Wilhelmsen, Tord Pedersens gt 83 A, 3014 DRAMMEN
(55)	Designavbildninger:	

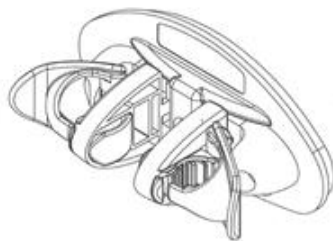

1.1

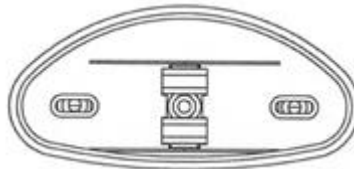

1.2

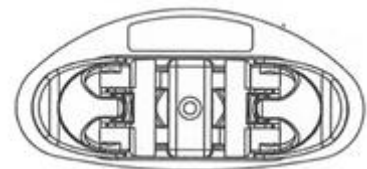

1.3

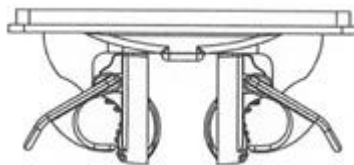

1.4

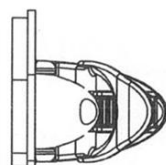

1.5

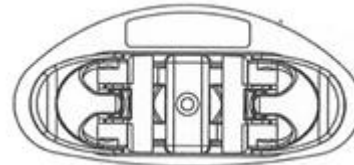

(11) **Reg.nr.:** 083984
(21) **Søkn.nr.:** 20130376
(22) **Inngitt:** 2013.04.23
(24) **Løpedag:** 2013.04.23
(43) **Allm. tilgj.:** 2013.04.23
(15) **Registrert:** 2013.06.10
(45) **Kunngjort:** 2013.07.08
(18) **Reg. gjelder til:** 2018.04.23
(74) **Fullmektig:** Zacco Norway AS, Postboks 2003 Vika, 0125 OSLO, Norge
(73) **Innehaver:** Sony Computer Entertainment Inc, 1-7-1 Konan Minato-ku, JP- TOKYO, Japan

Design 1

(54) **Produkt:** Kamera
(51) **Klasse:** 16-01
(72) **Designner:** Taichi Nokuo, c/o Sony Computer Entertainment Inc. 1-7-1 Konan Minato-ku TOKYO, Japan (JP)
Tetsu Sumii, c/o Sony Computer Entertainment Inc. 1-7-1 Konan, Minato-ku TOKYO, Japan (JP)
(30) **Prioritet:** 2012.11.06, JP, 2012-027072, 1
(55) **Designavbildninger:**

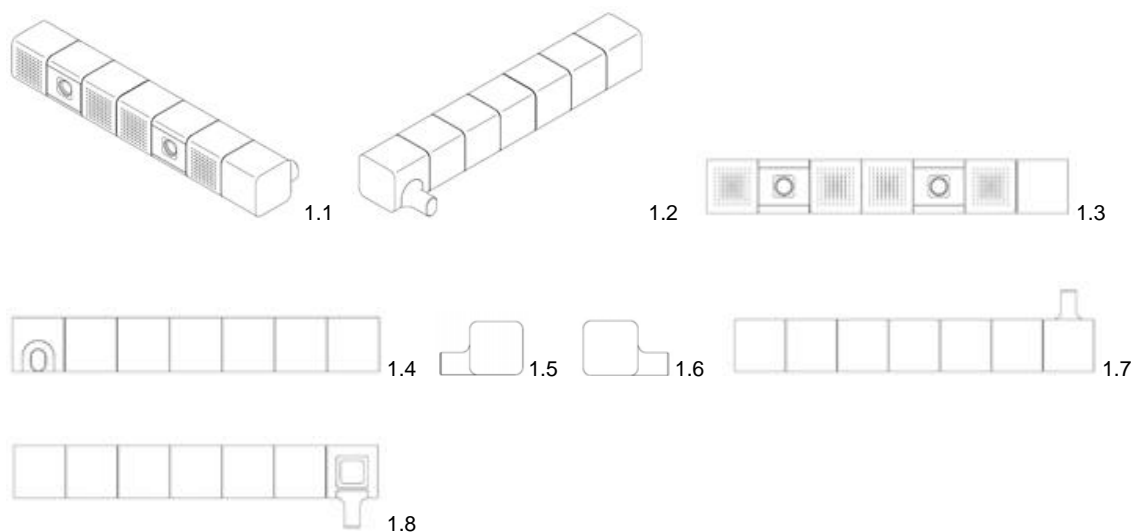

- (11) **Reg.nr.:** 083985
(21) **Søkn.nr.:** 20130371
(22) **Inngitt:** 2013.04.19
(24) **Løpedag:** 2013.04.19
(43) **Allm. tilgj.:** 2013.06.11
(15) **Registrert:** 2013.06.11
(45) **Kunngjort:** 2013.07.08
(18) **Reg. gjelder til:** 2018.04.19
(74) **Fullmektig:** Curo AS, Industriveien 53, 7080 HEIMDAL, Norge
(73) **Innehaver:** Magnus Rishaug, Rosenborgs gt. 18B, 7014 TRONDHEIM, Norge
Ivar Jørpeland, Rosenborgs gt. 18B, 7014 TRONDHEIM, Norge
(50) **Anmerkninger:** Registreringen gjelder samregistrering.

Design 1

- (54) **Produkt:** Modul for spotbelysning
(51) **Klasse:** 26-05
(72) **Designer:** Magnus Rishaug, Rosenborgs gt. 18B, 7014 TRONDHEIM
Ivar Jørpeland, Sigrid Johansens vei 17, 7025 TRONDHEIM
(55) **Designavbildninger:**

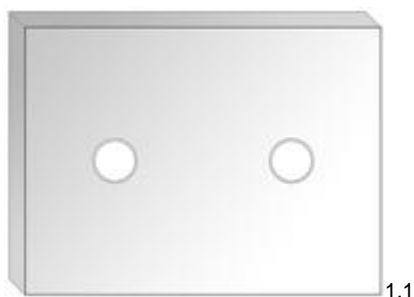

Design 2

- (54) **Produkt:** Modul for spotbelysning
(51) **Klasse:** 26-05
(72) **Designer:** Magnus Rishaug, Rosenborgs gt. 18B, 7014 TRONDHEIM
Ivar Jørpeland, Sigrid Johansens vei 17, 7025 TRONDHEIM
(55) **Designavbildninger:**

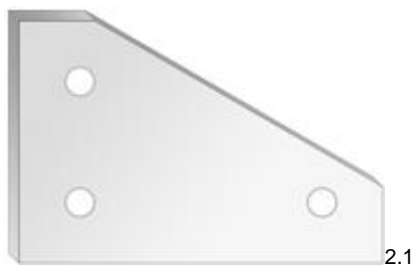

Design 3

- (54) **Produkt:** Modul for spotbelysning
(51) **Klasse:** 26-05
(72) **Designer:** Magnus Rishaug, Rosenborgs gt. 18B, 7014 TRONDHEIM
Ivar Jørpeland, Sigrid Johansens vei 17, 7025 TRONDHEIM
(55) **Designavbildninger:**

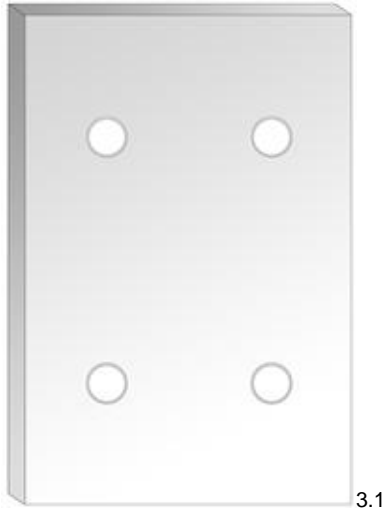
**Design 4**

- (54) **Produkt:** Modul for spotbelysning
(51) **Klasse:** 26-05
(72) **Designer:** Magnus Rishaug, Rosenborgs gt. 18B, 7014 TRONDHEIM
Ivar Jørpeland, Sigrid Johansens vei 17, 7025 TRONDHEIM
(55) **Designavbildninger:**

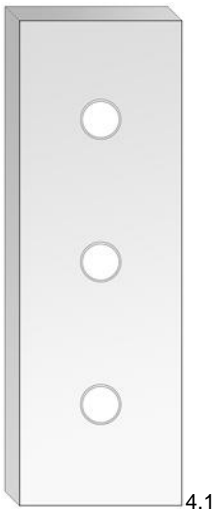

Design 5

- (54) **Produkt:** Modul for spotbelysning
(51) **Klasse:** 26-05
(72) **Designer:** Magnus Rishaug, Rosenborgs gt. 18B, 7014 TRONDHEIM
Ivar Jørpeland, Sigrid Johansens vei 17, 7025 TRONDHEIM
(55) **Designavbildninger:**

**Design 6**

- (54) **Produkt:** Modul for spotbelysning
(51) **Klasse:** 26-05
(72) **Designer:** Magnus Rishaug, Rosenborgs gt. 18B, 7014 TRONDHEIM
Ivar Jørpeland, Sigrid Johansens vei 17, 7025 TRONDHEIM
(55) **Designavbildninger:**

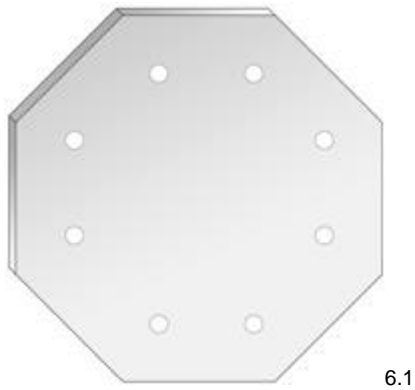
**Design 7**

- (54) **Produkt:** Modul for spotbelysning
(51) **Klasse:** 26-05
(72) **Designer:** Magnus Rishaug, Rosenborgs gt. 18B, 7014 TRONDHEIM
Ivar Jørpeland, Sigrid Johansens vei 17, 7025 TRONDHEIM
(55) **Designavbildninger:**

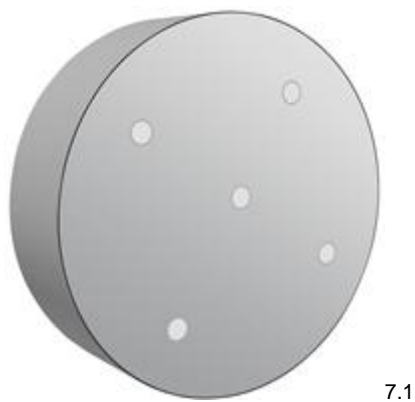

Design 8

- (54) **Produkt:** Modul for spotbelysning
(51) **Klasse:** 26-05
(72) **Designer:** Magnus Rishaug, Rosenborgs gt. 18B, 7014 TRONDHEIM
Ivar Jørpeland, Sigrid Johansens vei 17, 7025 TRONDHEIM
(55) **Designavbildninger:**

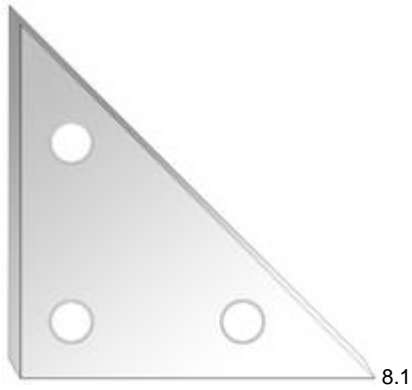

(11)	Reg.nr.:	083986
(21)	Søkn.nr.:	20130369
(22)	Inngitt:	2013.04.19
(24)	Løpedag:	2013.04.19
(43)	Allm. tilgj.:	2013.06.11
(15)	Registrert:	2013.06.11
(45)	Kunngjort:	2013.07.08
(18)	Reg. gjelder til:	2018.04.19
(74)	Fullmektig:	Oslo Patentkontor AS, Postboks 7007 Majorstua , 0306 OSLO, Norge
(73)	Innehaver:	Helly Hansen AS, Solgaard skog 139, 1599 MOSS, Norge

Design 1

(54)	Produkt:	Klær
(51)	Klasse:	02-02
(72)	Designer:	Helly Hansen ASA, Postboks 218, 1501 MOSS
(55)	Designavbildninger:	



1.1



1.2



1.3



1.4

(11)	Reg.nr.:	083987
(21)	Søkn.nr.:	20130370
(22)	Inngitt:	2013.04.19
(24)	Løpedag:	2013.04.19
(43)	Allm. tilgj.:	2013.06.11
(15)	Registrert:	2013.06.11
(45)	Kunngjort:	2013.07.08
(18)	Reg. gjelder til:	2018.04.19
(74)	Fullmektig:	Oslo Patentkontor AS, Postboks 7007 Majorstua , 0306 OSLO, Norge
(73)	Innehaber:	Helly Hansen AS, Solgaard skog 139, 1599 MOSS, Norge

Design 1

(54)	Produkt:	Klær
(72)	Designer:	Helly Hansen ASA, Postboks 218, 1501 MOSS
(55)	Designavbildninger:	



(11)	Reg.nr.:	083988
(21)	Søkn.nr.:	20130378
(22)	Inngitt:	2013.04.23
(24)	Løpedag:	2013.04.23
(43)	Allm. tilgj.:	2013.04.23
(15)	Registrert:	2013.06.13
(45)	Kunngjort:	2013.07.08
(18)	Reg. gjelder til:	2018.04.23
(74)	Fullmektig:	Oslo Patentkontor AS, Postboks 7007 Majorstua , 0306 OSLO, Norge
(73)	Innehaiver:	ABB OY, Strömbergintie 1, FI-00380 HELSINGFORS, Finland

Design 1

(54)	Produkt:	Koblingsboks
(51)	Klasse:	13-03
(72)	Designer:	Lars Didriksson, Jokikatu 25 A 1, 06100 PORVOO, Finland (FI)
(30)	Prioritet:	2012.11.09, EM, 2133397
(55)	Designavbildninger:	

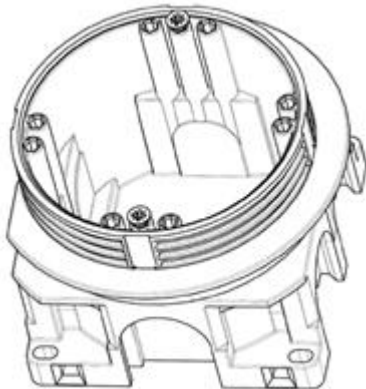

1.1

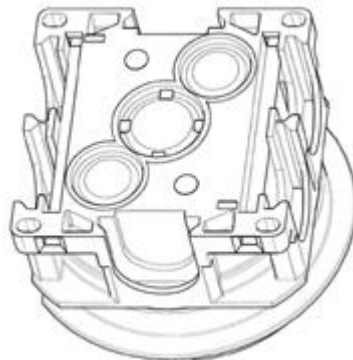

1.2

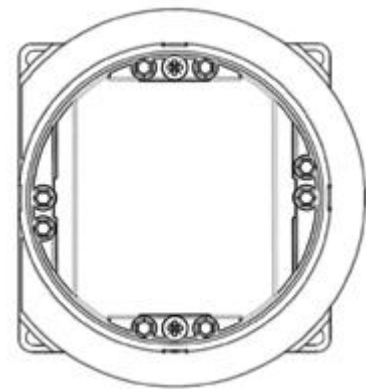

1.3

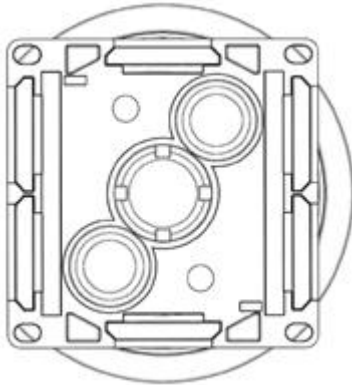

1.4

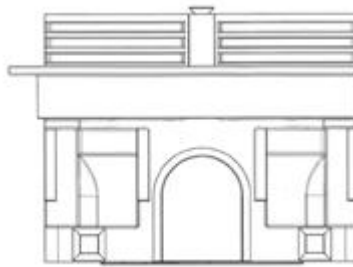

1.5

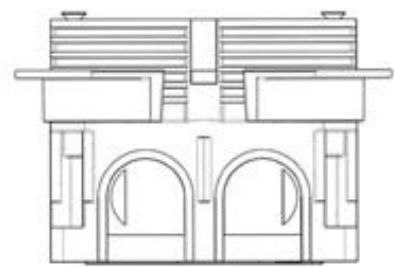

1.6

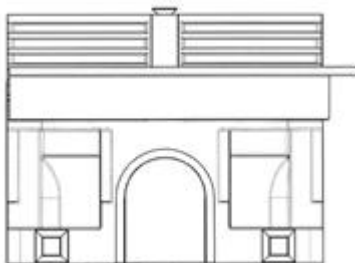

1.7

- (11) **Reg.nr.:** 083989
(21) **Søkn.nr.:** 20130327
(22) **Inngitt:** 2013.03.24
(24) **Løpedag:** 2013.03.24
(43) **Allm. tilgj.:** 2013.03.24
(15) **Registrert:** 2013.06.13
(45) **Kunngjort:** 2013.07.08
(18) **Reg. gjelder til:** 2018.03.24
(73) **Innehaver:** MALERMESTER GEIR KNÆDAL AS, Herregårdsveien 43, 1634 GAMLE FREDRIKSTAD, Norge
(50) **Anmerkninger:** Det er foretatt supplerende undersøkelse.

Design 1

- (54) **Produkt:** Køyeseng
(51) **Klasse:** 06-02
(72) **Designer:** MALERMESTER GEIR KNÆDAL AS, Herregårdsveien 43, 1634 GAMLE FREDRIKSTAD
(50) **Anmerkning:** Det er foretatt supplerende undersøkelse.
(55) **Designavbildninger:**



1.1

- (11) **Reg.nr.:** 083990
(21) **Søkn.nr.:** 20130342
(22) **Inngitt:** 2013.04.05
(24) **Løpedag:** 2013.04.05
(43) **Allm. tilgj.:** 2013.06.13
(15) **Registrert:** 2013.06.13
(45) **Kunngjort:** 2013.07.08
(18) **Reg. gjelder til:** 2018.04.05
(74) **Fullmektig:** Advokatfirmaet Horgen og Horgen AS, Karl Johans gate 25, 0159 OSLO, Norge
(73) **Innehaver:** PRINCESS-GRUPPEN AS, Postboks 90, 1401 SKI, Norge
(50) **Anmerkninger:** Designene er i farger.
Registreringen gjelder samregistrering.
Det er foretatt supplerende undersøkelse.

Design 1

- (54) **Produkt:** Ornament
(51) **Klasse:** 32-00
(72) **Designer:** PRINCESS-GRUPPEN AS, Postboks 90, 1401 SKI
(50) **Anmerkning:** Designen er i farger. Det er foretatt supplerende undersøkelse.
(55) **Designavbildninger:**



1.1

Design 2

- (54) **Produkt:** Ornament
(51) **Klasse:** 32-00
(72) **Designer:** PRINCESS-GRUPPEN AS, Postboks 90, 1401 SKI
(50) **Anmerkning:** Designen er i farger. Det er foretatt supplerende undersøkelse.
(55) **Designavbildninger:**



2.1

Design 3

- (54) **Produkt:** Ornamment
(51) **Klasse:** 32-00
(72) **Designer:** PRINCESS-GRUPPEN AS, Postboks 90, 1401 SKI
(50) **Anmerkning:** Designen er i farger. Det er foretatt supplerende undersøkelse.
(55) **Designavbildninger:**



3.1

Design 4

- (54) **Produkt:** Ornamment
(51) **Klasse:** 32-00
(72) **Designer:** PRINCESS-GRUPPEN AS, Postboks 90, 1401 SKI
(50) **Anmerkning:** Designen er i farger. Det er foretatt supplerende undersøkelse.
(55) **Designavbildninger:**



4.1

Design 5

- (54) **Produkt:** Ornamment
(51) **Klasse:** 32-00
(72) **Designer:** PRINCESS-GRUPPEN AS, Postboks 90, 1401 SKI
(50) **Anmerkning:** Designen er i farger. Det er foretatt supplerende undersøkelse.
(55) **Designavbildninger:**



5.1

Design 6

- (54) **Produkt:** Ornamment
(51) **Klasse:** 32-00
(72) **Designer:** PRINCESS-GRUPPEN AS, Postboks 90, 1401 SKI
(50) **Anmerkning:** Designen er i farger. Det er foretatt supplerende undersøkelse.
(55) **Designavbildninger:**



6.1

Design 7

- (54) **Produkt:** Ornamment
(51) **Klasse:** 32-00
(72) **Designer:** PRINCESS-GRUPPEN AS, Postboks 90, 1401 SKI
(50) **Anmerkning:** Designen er i farger. Det er foretatt supplerende undersøkelse.
(55) **Designavbildninger:**



7.1

Design 8

- (54) **Produkt:** Ornamment
(51) **Klasse:** 32-00
(72) **Designer:** PRINCESS-GRUPPEN AS, Postboks 90, 1401 SKI
(50) **Anmerkning:** Designen er i farger. Det er foretatt supplerende undersøkelse.
(55) **Designavbildninger:**



8.1

Design 9

- (54) **Produkt:** Ornamment
(51) **Klasse:** 32-00
(72) **Designer:** PRINCESS-GRUPPEN AS, Postboks 90, 1401 SKI
(50) **Anmerkning:** Designen er i farger. Det er foretatt supplerende undersøkelse.
(55) **Designavbildninger:**



9.1

Design 10

- (54) **Produkt:** Ornamment
 (51) **Klasse:** 32-00
 (72) **Designer:** PRINCESS-GRUPPEN AS, Postboks 90, 1401 SKI
 (50) **Anmerkning:** Designen er i farger. Det er foretatt supplerende undersøkelse.
 (55) **Designavbildninger:**



10.1

- (11) **Reg.nr.:** 083991
 (21) **Søkn.nr.:** 20121066
 (22) **Inngitt:** 2012.12.14
 (24) **Løpedag:** 2012.12.14
 (43) **Allm. tilgj.:** 2012.12.14
 (15) **Registrert:** 2013.06.13
 (45) **Kunngjort:** 2013.07.08
 (18) **Reg. gjelder til:** 2017.12.14
 (73) **Innehaver:** Vigdis Antonie Olaussen, Sorgenfrigt. 38B, 0365 OSLO, Norge

Design 1

- (54) **Produkt:** To huskestoler festet i en stålampe med lys i topp
 (51) **Klasse:** 06-01
 26-05
 (72) **Designer:** Vigdis Antonie Olaussen, Sorgenfrigt. 38B, 0365 OSLO
 (55) **Designavbildninger:**

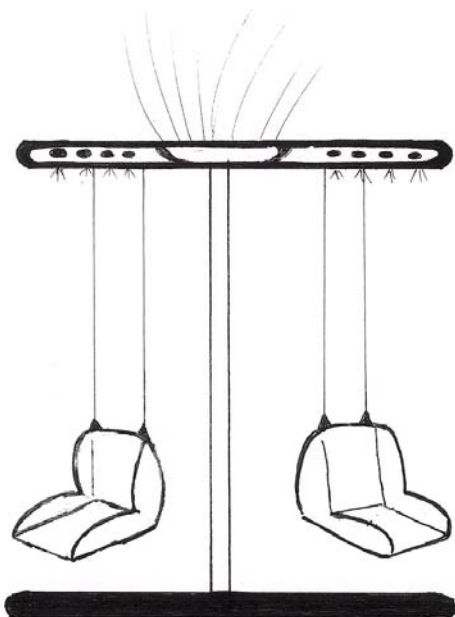

1.1

(11)	Reg.nr.:	083992
(21)	Søkn.nr.:	20130112
(22)	Inngitt:	2013.01.25
(24)	Løpedag:	2013.01.25
(43)	Allm. tilgj.:	2013.06.13
(15)	Registrert:	2013.06.13
(45)	Kunngjort:	2013.07.08
(18)	Reg. gjelder til:	2018.01.25
(73)	Innehaver:	ADDONS DESIGN AS, c/o Børre Veholt-Meinstad, Siriusvegen 56, 3942 PORSGRUNN, Norge
(50)	Anmerkninger:	Registreringen gjelder samregistrering.

Design 1

(54)	Produkt:	Del av skje
(51)	Klasse:	07-03
(72)	Designer:	PERNILLE BACHE DESIGN, Byfogd Pausgate 10, 3717 SKIEN
(55)	Designavbildninger:	



1.1

Design 2

(54)	Produkt:	Del av skje
(51)	Klasse:	07-03
(72)	Designer:	PERNILLE BACHE DESIGN, Byfogd Pausgate 10, 3717 SKIEN
(55)	Designavbildninger:	

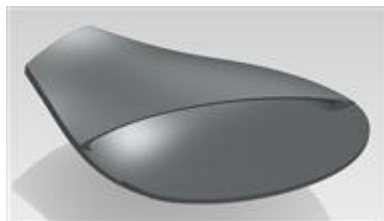

2.1

Design 3

(54)	Produkt:	Del av skje
(51)	Klasse:	07-03
(72)	Designer:	PERNILLE BACHE DESIGN, Byfogd Pausgate 10, 3717 SKIEN
(55)	Designavbildninger:	

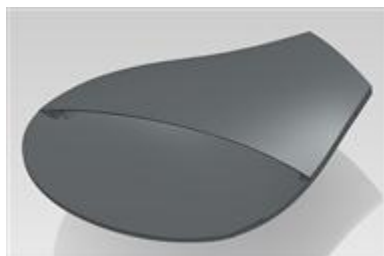

3.1

(11)	Reg.nr.:	083993
(21)	Søkn.nr.:	20130221
(22)	Inngitt:	2013.02.26
(24)	Løpedag:	2013.02.26
(43)	Allm. tilgj.:	2013.06.13
(15)	Registrert:	2013.06.13
(45)	Kunngjort:	2013.07.08
(18)	Reg. gjelder til:	2018.02.26
(73)	Innehaver:	INGUNHC - INGUN HOVDEN CHRISTENSEN, Skipstad 47, 1684 VESTERØY, Norge

Design 1

(54)	Produkt:	Halsnål
(51)	Klasse:	11-01
(72)	Designer:	INGUNHC - INGUN HOVDEN CHRISTENSEN, Skipstad 47, 1684 VESTERØY
(55)	Designavbildninger:	



1.1

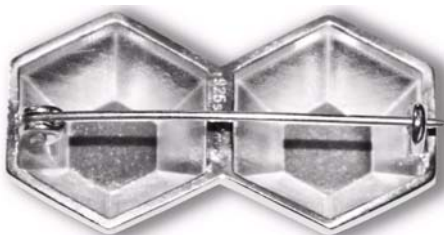

1.2

(11)	Reg.nr.:	083994
(21)	Søkn.nr.:	20130473
(22)	Inngitt:	2013.05.13
(24)	Løpedag:	2013.02.26
(43)	Allm. tilgj.:	2013.05.13
(15)	Registrert:	2013.06.13
(45)	Kunngjort:	2013.07.08
(18)	Reg. gjelder til:	2018.02.26
(73)	Innehaver:	INGUNHC - INGUN HOVDEN CHRISTENSEN, Skipstad 47, 1684 VESTERØY, Norge

Design 1

(54)	Produkt:	Mansjettknapp
(51)	Klasse:	02-07
(72)	Designer:	INGUNHC - INGUN HOVDEN CHRISTENSEN, Skipstad 47, 1684 VESTERØY
(55)	Designavbildninger:	



1.1



1.2

(11)	Reg.nr.:	083995
(21)	Søkn.nr.:	20130461
(22)	Inngitt:	2013.04.26
(24)	Løpedag:	2013.04.26
(43)	Allm. tilgj.:	2013.04.26
(15)	Registrert:	2013.06.14
(45)	Kunngjort:	2013.07.08
(18)	Reg. gjelder til:	2018.04.26
(74)	Fullmektig:	Onsagers AS, Postboks 1813 Vika, 0123 OSLO, Norge
(73)	Innehaver:	K-2 Corporation, 4201 Sixth Avenue South, US-WA98108 SEATTLE, USA
(50)	Anmerkninger:	Registreringen gjelder samregistrering.

Design 1

(54)	Produkt:	Del av såle til skistøvel
(51)	Klasse:	02-04
(72)	Designer:	John Svensson, 4201 Sixth Avenue South, WA98108 SEATTLE, USA (US) James Sener, 4201 Sixth Avenue South, WA98108 SEATTLE, USA (US) Mark Williams, 4201 Sixth Avenue South, WA98108 SEATTLE, USA (US)
(30)	Prioritet:	2012.10.29, EM, 002126532, 1, 2, 3
(55)	Designavbildninger:	

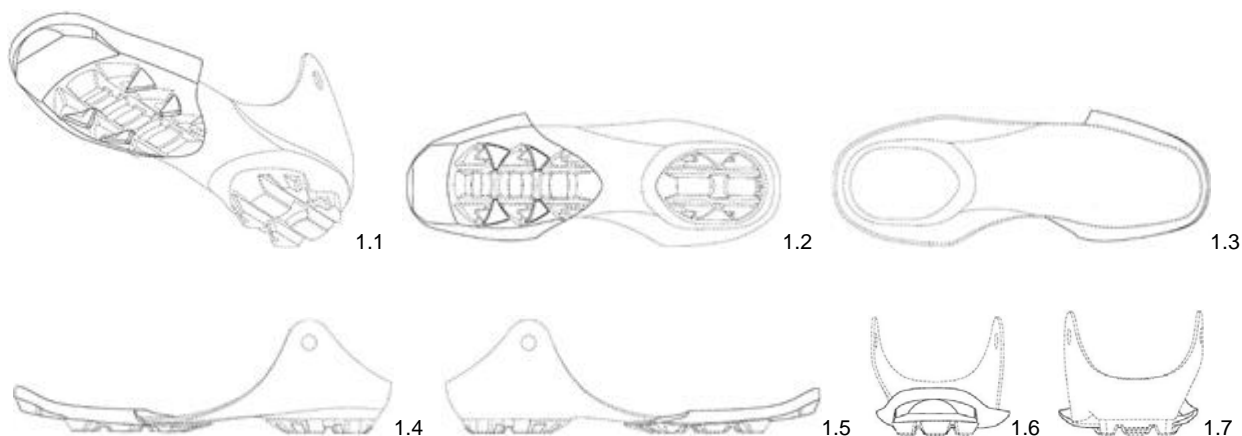
**Design 2**

(54)	Produkt:	Såle til skistøvel
(51)	Klasse:	02-04
(72)	Designer:	John Svensson, 4201 Sixth Avenue South, WA98108 SEATTLE, USA (US) James Sener, 4201 Sixth Avenue South, WA98108 SEATTLE, USA (US) Mark Williams, 4201 Sixth Avenue South, WA98108 SEATTLE, USA (US)
(30)	Prioritet:	2012.10.29, EM, 002126532, 1, 2, 3
(55)	Designavbildninger:	

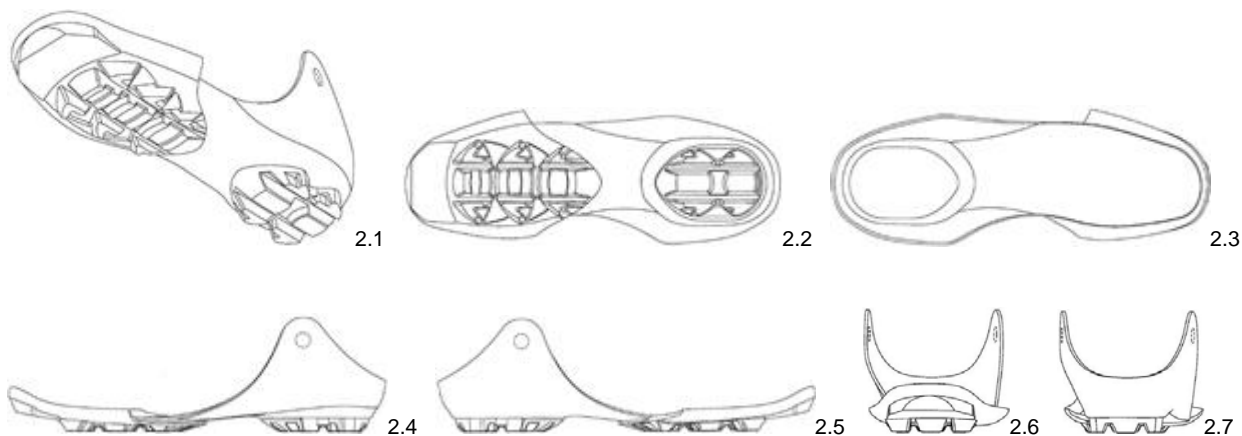

Design 3

- (54) **Produkt:** Del av såle til skistøvel
 (51) **Klasse:** 02-04
 (72) **Design:** John Svensson, 4201 Sixth Avenue South, WA98108 SEATTLE, USA (US)
 James Sener, 4201 Sixth Avenue South, WA98108 SEATTLE, USA (US)
 Mark Williams, 4201 Sixth Avenue South, WA98108 SEATTLE, USA (US)
 (30) **Prioritet:** 2012.10.29, EM, 002126532, 1, 2, 3
 (55) **Designavbildninger:**

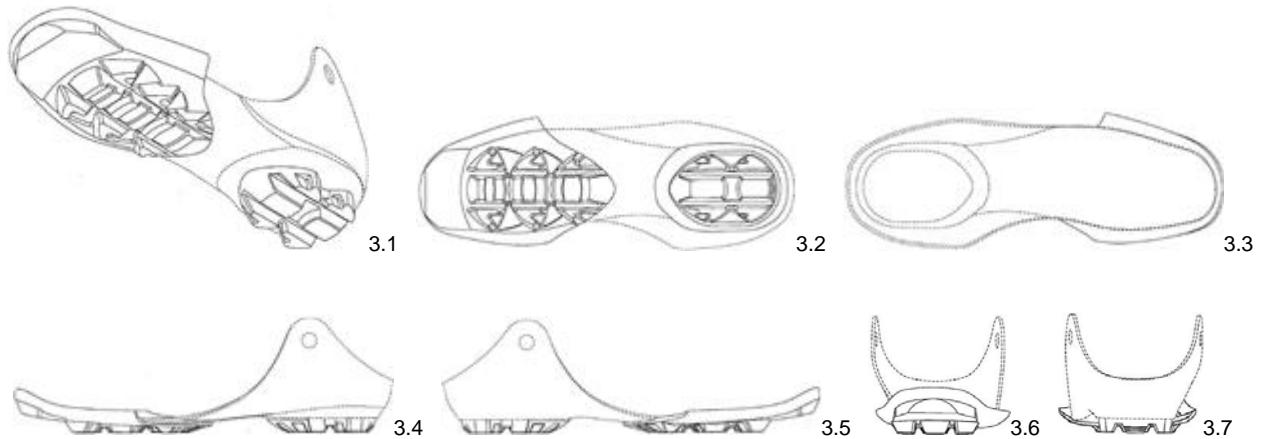
**Design 4**

- (54) **Produkt:** Del av såle til skistøvel
 (51) **Klasse:** 02-04
 (72) **Design:** John Svensson, 4201 Sixth Avenue South, WA98108 SEATTLE, USA (US)
 James Sener, 4201 Sixth Avenue South, WA98108 SEATTLE, USA (US)
 Mark Williams, 4201 Sixth Avenue South, WA98108 SEATTLE, USA (US)
 (30) **Prioritet:** 2012.10.26, US, 29/435,744, 4
 (55) **Designavbildninger:**

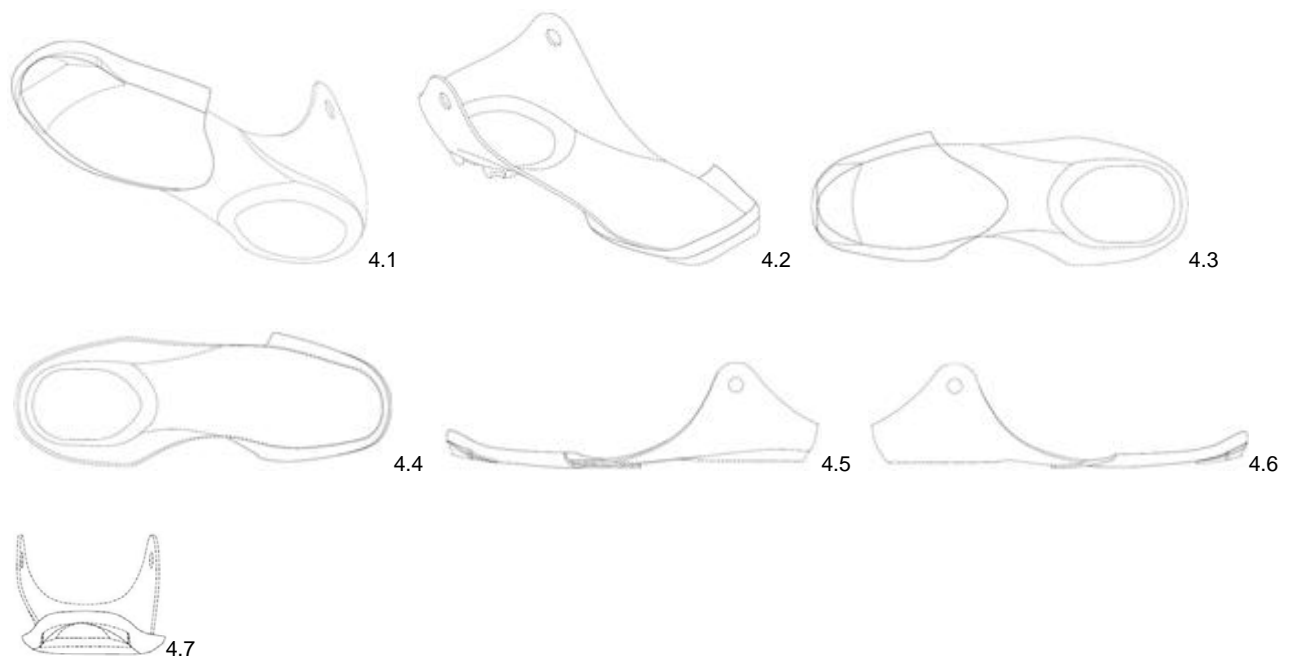

Design 5

- (54) **Produkt:** Del av såle til skistøvel
 (51) **Klasse:** 02-04
 (72) **Designer:** John Svensson, 4201 Sixth Avenue South, WA98108 SEATTLE, USA (US)
 James Sener, 4201 Sixth Avenue South, WA98108 SEATTLE, USA (US)
 Mark Williams, 4201 Sixth Avenue South, WA98108 SEATTLE, USA (US)
 (30) **Prioritet:** 2012.10.26, US, 29/435,747, 5
 (55) **Designavbildninger:**

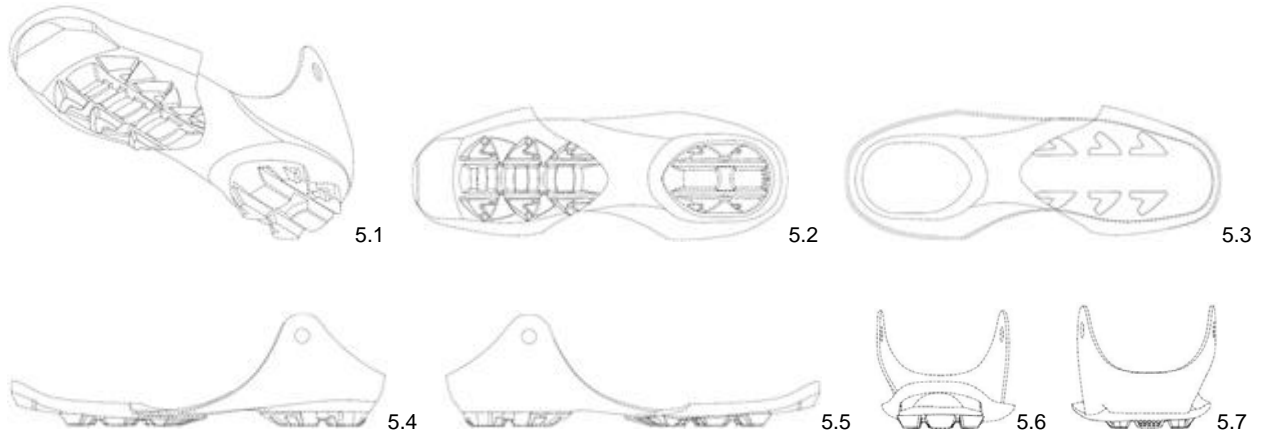
**Design 6**

- (54) **Produkt:** Såle til skistøvel
 (51) **Klasse:** 02-04
 (72) **Designer:** John Svensson, 4201 Sixth Avenue South, WA98108 SEATTLE, USA (US)
 James Sener, 4201 Sixth Avenue South, WA98108 SEATTLE, USA (US)
 Mark Williams, 4201 Sixth Avenue South, WA98108 SEATTLE, USA (US)
 (30) **Prioritet:** 2012.10.26, US, 29/435,706, 6
 (55) **Designavbildninger:**

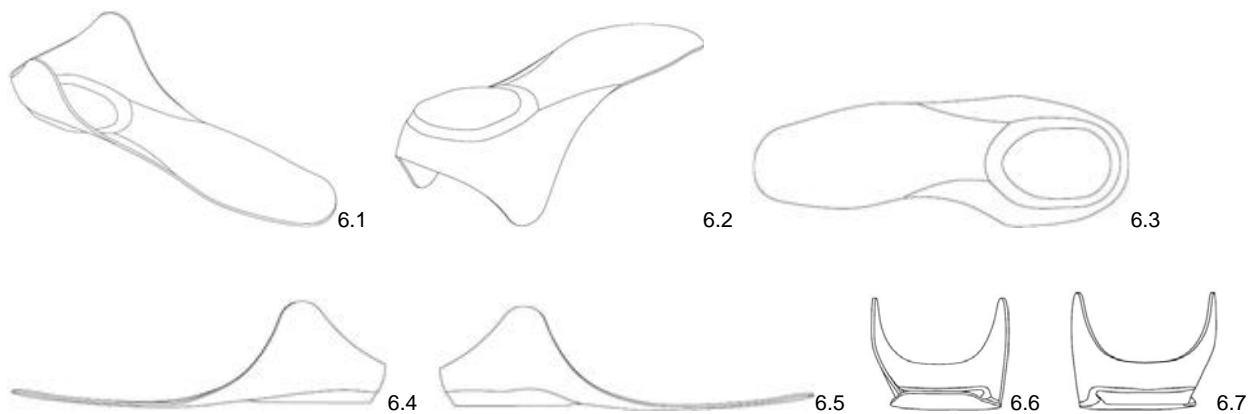

Design 7

- (54) **Produkt:** Såle til skistøvel
(51) **Klasse:** 02-04
(72) **Designer:** John Svensson, 4201 Sixth Avenue South, WA98108 SEATTLE, USA (US)
James Sener, 4201 Sixth Avenue South, WA98108 SEATTLE, USA (US)
Mark Williams, 4201 Sixth Avenue South, WA98108 SEATTLE, USA (US)
(30) **Prioritet:** 2012.10.26, US, 29/435,748, 7
(55) **Designavbildninger:**

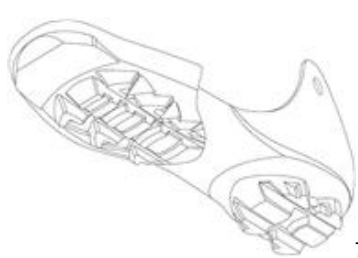

7.1



7.2

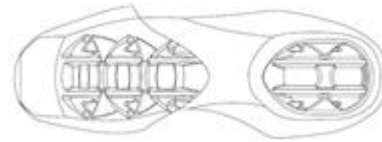

7.3



7.4



7.5



7.6



7.7

- (11) **Reg.nr.:** 083996
(21) **Søkn.nr.:** 20130360
(22) **Inngitt:** 2013.04.16
(24) **Løpedag:** 2013.04.16
(43) **Allm. tilgj.:** 2013.06.14
(15) **Registrert:** 2013.06.14
(45) **Kunngjort:** 2013.07.08
(18) **Reg. gjelder til:** 2018.04.16
(73) **Innehaver:** Stella Baby AS, Vøyensvingen 19B, 0458 OSLO, Norge
(50) **Anmerkninger:** Designen er i farger.

Design 1

- (54) **Produkt:** Stellematte
(51) **Klasse:** 06-09
(72) **Designner:** Stella Baby AS, c/o Lotte Fredriksen, Vøyensvingen 19b, 0458 OSLO
Lotte Fredriksen, Vøyensvingen 19b, 0458 OSLO
Caroline Myrdahl, Brinken 57, 2050 JESSHEIM
(50) **Anmerkning:** Designen er i farger.
(55) **Designavbildninger:**



1.1



1.2



1.3



1.4

- (11) **Reg.nr.:** 083997
 (21) **Søkn.nr.:** 20130224
 (22) **Inngitt:** 2013.02.27
 (24) **Løpedag:** 2013.02.27
 (43) **Allm. tilgj.:** 2013.04.01
 (15) **Registrert:** 2013.06.14
 (45) **Kunngjort:** 2013.07.08
 (18) **Reg. gjelder til:** 2018.02.27
 (74) **Fullmektig:** Zacco Norway AS, Postboks 2003 Vika, 0125 OSLO, Norge
 (73) **Innehaver:** Harald Magnus Jansen, Lyngveien 1, 4630 KRISTIANSAND S, Norge
 (50) **Anmerkninger:** Registreringen gjelder samregistrering.

Design 1

- (54) **Produkt:** Profil for bygningsformål
 (51) **Klasse:** 25-01
 (72) **Designer:** Harald Magnus Jansen, Lyngveien 1, 4630 KRISTIANSAND S
 (55) **Designavbildninger:**

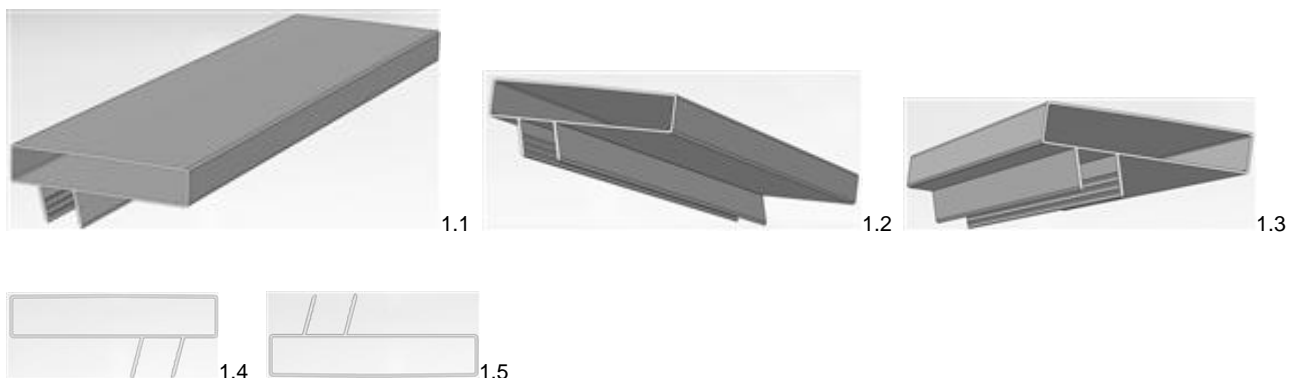
**Design 2**

- (54) **Produkt:** Profil for bygningsformål
 (51) **Klasse:** 25-01
 (72) **Designer:** Harald Magnus Jansen, Lyngveien 1, 4630 KRISTIANSAND S
 (55) **Designavbildninger:**

**Design 3**

- (54) **Produkt:** Profil for bygningsformål
 (51) **Klasse:** 25-01
 (72) **Designer:** Harald Magnus Jansen, Lyngveien 1, 4630 KRISTIANSAND S
 (55) **Designavbildninger:**





(11)	Reg.nr.:	083998
(21)	Søkn.nr.:	20130255
(22)	Inngitt:	2013.03.20
(24)	Løpedag:	2013.03.20
(43)	Allm. tilgj.:	2013.03.27
(15)	Registrert:	2013.06.14
(45)	Kunngjort:	2013.07.08
(18)	Reg. gjelder til:	2018.03.20
(74)	Fullmektig:	Bryn Aarflot AS, Postboks 449 Sentrum, 0104 OSLO, Norge
(73)	Innehaver:	Glaxo Group Limited, 980 Great West Road, GB-TW89GS BRENTFORD, MIDDLESEX , Storbritannia

Design 1

(54)	Produkt:	Bitering
(51)	Klasse:	24-04
(72)	Designer:	Simon Ritchie, c/o GlaxoSmithKline, St. Georges Avenue, KT130DE WEYBRIDGE, SURREY, Storbritannia (GB) Marcus Blachford, c/o DCA Design International Ltd, 19 Church Street, CV344AB WARWICK, Storbritannia (GB) Alex Brian, c/o GlaxoSmithKline, St. Georges Avenue, KT130DE WEYBRIDGE, SURREY, Storbritannia (GB) Andrew Mitchell, c/o DCA Design International Ltd, 19 Church Street, CV344AB WARWICK, Storbritannia (GB)
(30)	Prioritet:	2012.09.27, GB, 4026505
(55)	Designavbildninger:	

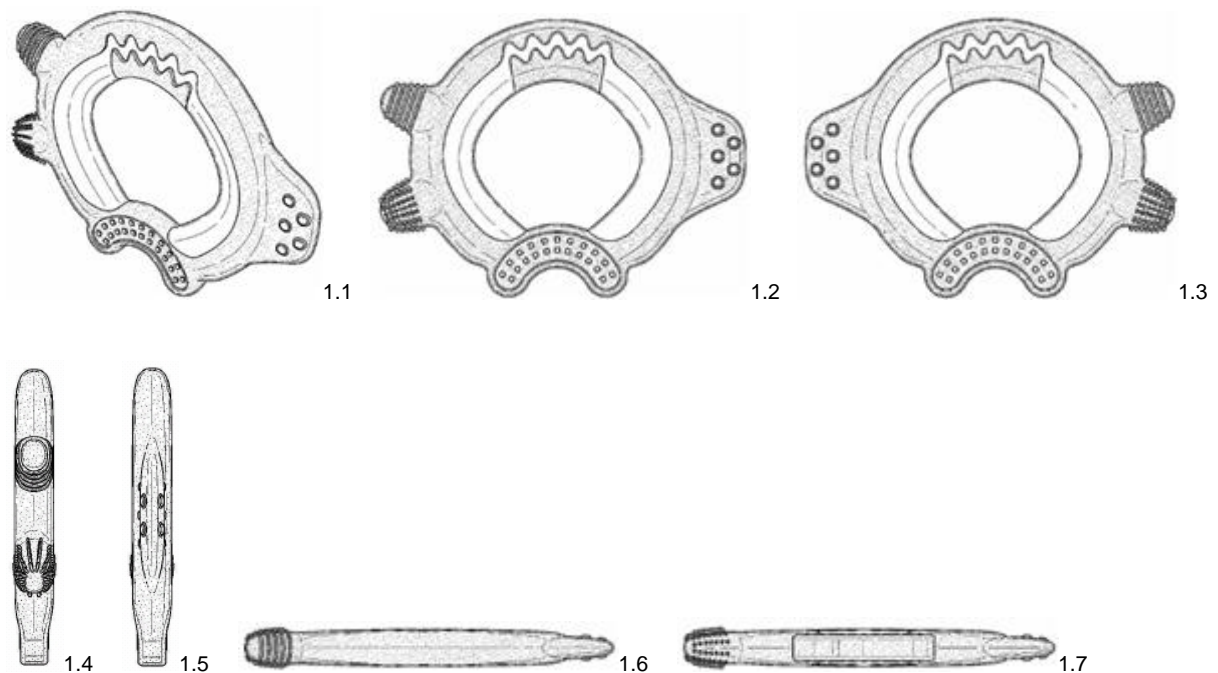

(11)	Reg.nr.:	083999
(21)	Søkn.nr.:	20121143
(22)	Inngitt:	2012.12.19
(24)	Løpedag:	2012.12.19
(43)	Allm. tilgj.:	2012.12.20
(15)	Registrert:	2013.06.14
(45)	Kunngjort:	2013.07.08
(18)	Reg. gjelder til:	2017.12.19
(74)	Fullmektig:	Bryn Aarflot AS, Postboks 449 Sentrum, 0104 OSLO, Norge
(73)	Innehaver:	Microsoft Corp, One Microsoft Way, US-WA98052-6399 REDMOND, USA
(50)	Anmerkninger:	Registreringen gjelder samregistrering.

Design 1

(54)	Produkt:	Visningsskjerm med brukergrensesnitt
(51)	Klasse:	14-04
(72)	Designert:	Jeffrey G Arnold, c/o Microsoft Corp, One Microsoft Way, WA98052 REDMOND, USA (US) Megan Donahue, c/o Microsoft Corporation, One Microsoft Way, WA98052 REDMOND, USA (US) Chad Michael Roberts, c/o Microsoft Corporation, One Microsoft Way, WA98052 REDMOND, USA (US) Rhoniell Villano Manlapaz, c/o Microsoft Corporation, One Microsoft Way, WA98052 REDMOND, USA (US) Cara Lyn Tyler, c/o Microsoft Corporation, One Microsoft Way, WA98052 REDMOND, USA (US) Andrea Michelle Simons, c/o Microsoft Corporation, One Microsoft Way, WA98052 REDMOND, USA (US) Theodore Aaron Haberman, c/o Microsoft Corporation, One Microsoft Way, WA98052 REDMOND, USA (US) Jeremy Monroe Bowen, c/o Microsoft Corporation, One Microsoft Way, WA98052 REDMOND, USA (US) Lori Beth Kratzer, c/o Microsoft Corporation, One Microsoft Way, WA98052 REDMOND, USA (US) Joseph Spencer King, c/o Microsoft Corporation, One Microsoft Way, WA98052 REDMOND, USA (US) Josh Phillips, c/o Microsoft Corporation, One Microsoft Way, WA98052 REDMOND, USA (US) Dawn Wilson, c/o Microsoft Corporation, One Microsoft Way, WA98052 REDMOND, USA (US) Joyce S Chou, c/o Microsoft Corporation, One Microsoft Way, WA98052 REDMOND, USA (US) Sogol Malekzadeh, c/o Microsoft Corporation, One Microsoft Way, WA98052 REDMOND, USA (US) Jae Park, c/o Microsoft Corporation, One Microsoft Way, WA98052 REDMOND, USA (US) Kristina Voros, c/o Microsoft Corporation, One Microsoft Way, WA98052 REDMOND, USA (US) Jonathan Aroner, c/o Microsoft Corporation, One Microsoft Way, WA98052 REDMOND, USA (US)

(55) **Designavbildninger:**

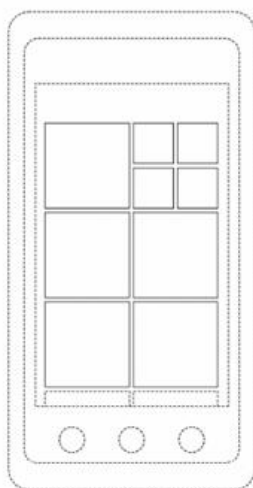

1.1

Design 2

- (54) **Produkt:** Ikon for visnings skjerm
- (51) **Klasse:** 14-04
- (72) **Designer:** Jeffrey G Arnold, c/o Microsoft Corp, One Microsoft Way, WA98052 REDMOND, USA (US)
Megan Donahue, c/o Microsoft Corporation, One Microsoft Way, WA98052 REDMOND, USA (US)
Chad Michael Roberts, c/o Microsoft Corporation, One Microsoft Way, WA98052 REDMOND, USA (US)
Rhoniell Villano Manlapaz, c/o Microsoft Corporation, One Microsoft Way, WA98052 REDMOND, USA (US)
Cara Lyn Tyler, c/o Microsoft Corporation, One Microsoft Way, WA98052 REDMOND, USA (US)
Andrea Michelle Simons, c/o Microsoft Corporation, One Microsoft Way, WA98052 REDMOND, USA (US)
Theodore Aaron Haberman, c/o Microsoft Corporation, One Microsoft Way, WA98052 REDMOND, USA (US)
Jeremy Monroe Bowen, c/o Microsoft Corporation, One Microsoft Way, WA98052 REDMOND, USA (US)
Lori Beth Kratzer, c/o Microsoft Corporation, One Microsoft Way, WA98052 REDMOND, USA (US)
Joseph Spencer King, c/o Microsoft Corporation, One Microsoft Way, WA98052 REDMOND, USA (US)
Josh Phillips, c/o Microsoft Corporation, One Microsoft Way, WA98052 REDMOND, USA (US)
Dawn Wilson, c/o Microsoft Corporation, One Microsoft Way, WA98052 REDMOND, USA (US)
Joyce S Chou, c/o Microsoft Corporation, One Microsoft Way, WA98052 REDMOND, USA (US)
Sogol Malekzadeh, c/o Microsoft Corporation, One Microsoft Way, WA98052 REDMOND, USA (US)
Jae Park, c/o Microsoft Corporation, One Microsoft Way, WA98052 REDMOND, USA (US)
Kristina Voros, c/o Microsoft Corporation, One Microsoft Way, WA98052 REDMOND, USA (US)
Jonathan Aroner, c/o Microsoft Corporation, One Microsoft Way, WA98052 REDMOND, USA (US)
- (30) **Prioritet:** 2012.06.20, US, 29/425,220, 2
- (55) **Designavbildninger:**

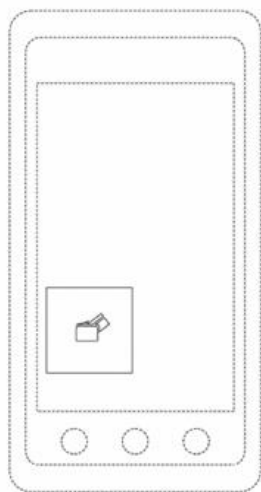

2.1

Design 3

- (54) **Produkt:** Ikon for visnings skjerm
(51) **Klasse:** 14-04
(72) **Designer:** Jeffrey G Arnold, c/o Microsoft Corp, One Microsoft Way, WA98052 REDMOND, USA (US)
Megan Donahue, c/o Microsoft Corporation, One Microsoft Way, WA98052 REDMOND, USA (US)
Chad Michael Roberts, c/o Microsoft Corporation, One Microsoft Way, WA98052 REDMOND, USA (US)
Rhoniell Villano Manlapaz, c/o Microsoft Corporation, One Microsoft Way, WA98052 REDMOND, USA (US)
Cara Lyn Tyler, c/o Microsoft Corporation, One Microsoft Way, WA98052 REDMOND, USA (US)
Andrea Michelle Simons, c/o Microsoft Corporation, One Microsoft Way, WA98052 REDMOND, USA (US)
Theodore Aaron Haberman, c/o Microsoft Corporation, One Microsoft Way, WA98052 REDMOND, USA (US)
Jeremy Monroe Bowen, c/o Microsoft Corporation, One Microsoft Way, WA98052 REDMOND, USA (US)
Lori Beth Kratzer, c/o Microsoft Corporation, One Microsoft Way, WA98052 REDMOND, USA (US)
Joseph Spencer King, c/o Microsoft Corporation, One Microsoft Way, WA98052 REDMOND, USA (US)
Josh Phillips, c/o Microsoft Corporation, One Microsoft Way, WA98052 REDMOND, USA (US)
Dawn Wilson, c/o Microsoft Corporation, One Microsoft Way, WA98052 REDMOND, USA (US)
Joyce S Chou, c/o Microsoft Corporation, One Microsoft Way, WA98052 REDMOND, USA (US)
Sogol Malekzadeh, c/o Microsoft Corporation, One Microsoft Way, WA98052 REDMOND, USA (US)
Jae Park, c/o Microsoft Corporation, One Microsoft Way, WA98052 REDMOND, USA (US)
Kristina Voros, c/o Microsoft Corporation, One Microsoft Way, WA98052 REDMOND, USA (US)
Jonathan Aroner, c/o Microsoft Corporation, One Microsoft Way, WA98052 REDMOND, USA (US)
- (30) **Prioritet:** 2012.06.20, US, 29/425,215, 3, 16
(55) **Designavbildninger:**

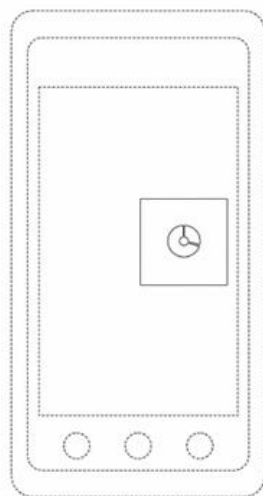

3.1

Design 4

- (54) **Produkt:** Ikon for visnings skjerm
- (51) **Klasse:** 14-04
- (72) **Designer:** Jeffrey G Arnold, c/o Microsoft Corp, One Microsoft Way, WA98052 REDMOND, USA (US)
Megan Donahue, c/o Microsoft Corporation, One Microsoft Way, WA98052 REDMOND, USA (US)
Chad Michael Roberts, c/o Microsoft Corporation, One Microsoft Way, WA98052 REDMOND, USA (US)
Rhoniell Villano Manlapaz, c/o Microsoft Corporation, One Microsoft Way, WA98052 REDMOND, USA (US)
Cara Lyn Tyler, c/o Microsoft Corporation, One Microsoft Way, WA98052 REDMOND, USA (US)
Andrea Michelle Simons, c/o Microsoft Corporation, One Microsoft Way, WA98052 REDMOND, USA (US)
Theodore Aaron Haberman, c/o Microsoft Corporation, One Microsoft Way, WA98052 REDMOND, USA (US)
Jeremy Monroe Bowen, c/o Microsoft Corporation, One Microsoft Way, WA98052 REDMOND, USA (US)
Lori Beth Kratzer, c/o Microsoft Corporation, One Microsoft Way, WA98052 REDMOND, USA (US)
Joseph Spencer King, c/o Microsoft Corporation, One Microsoft Way, WA98052 REDMOND, USA (US)
Josh Phillips, c/o Microsoft Corporation, One Microsoft Way, WA98052 REDMOND, USA (US)
Dawn Wilson, c/o Microsoft Corporation, One Microsoft Way, WA98052 REDMOND, USA (US)
Joyce S Chou, c/o Microsoft Corporation, One Microsoft Way, WA98052 REDMOND, USA (US)
Sogol Malekzadeh, c/o Microsoft Corporation, One Microsoft Way, WA98052 REDMOND, USA (US)
Jae Park, c/o Microsoft Corporation, One Microsoft Way, WA98052 REDMOND, USA (US)
Kristina Voros, c/o Microsoft Corporation, One Microsoft Way, WA98052 REDMOND, USA (US)
Jonathan Aroner, c/o Microsoft Corporation, One Microsoft Way, WA98052 REDMOND, USA (US)
- (30) **Prioritet:** 2012.06.20, US, 29/425,216, 4
- (55) **Designavbildninger:**

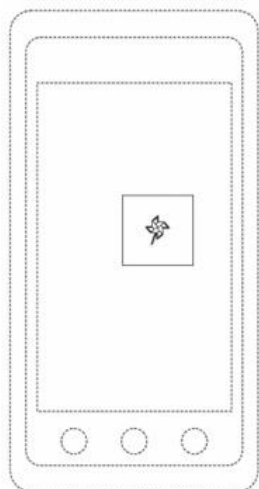

4.1

Design 5

- (54) **Produkt:** Visningsskjerm med brukergrensesnitt
- (51) **Klasse:** 14-04
- (72) **Designer:** Jeffrey G Arnold, c/o Microsoft Corp, One Microsoft Way, WA98052 REDMOND, USA (US)
Megan Donahue, c/o Microsoft Corporation, One Microsoft Way, WA98052 REDMOND, USA (US)
Chad Michael Roberts, c/o Microsoft Corporation, One Microsoft Way, WA98052 REDMOND, USA (US)
Rhoniell Villano Manlapaz, c/o Microsoft Corporation, One Microsoft Way, WA98052 REDMOND, USA (US)
Cara Lyn Tyler, c/o Microsoft Corporation, One Microsoft Way, WA98052 REDMOND, USA (US)
Andrea Michelle Simons, c/o Microsoft Corporation, One Microsoft Way, WA98052 REDMOND, USA (US)
Theodore Aaron Haberman, c/o Microsoft Corporation, One Microsoft Way, WA98052 REDMOND, USA (US)
Jeremy Monroe Bowen, c/o Microsoft Corporation, One Microsoft Way, WA98052 REDMOND, USA (US)
Lori Beth Kratzer, c/o Microsoft Corporation, One Microsoft Way, WA98052 REDMOND, USA (US)
Joseph Spencer King, c/o Microsoft Corporation, One Microsoft Way, WA98052 REDMOND, USA (US)
Josh Phillips, c/o Microsoft Corporation, One Microsoft Way, WA98052 REDMOND, USA (US)
Dawn Wilson, c/o Microsoft Corporation, One Microsoft Way, WA98052 REDMOND, USA (US)
Joyce S Chou, c/o Microsoft Corporation, One Microsoft Way, WA98052 REDMOND, USA (US)
Sogol Malekzadeh, c/o Microsoft Corporation, One Microsoft Way, WA98052 REDMOND, USA (US)
Jae Park, c/o Microsoft Corporation, One Microsoft Way, WA98052 REDMOND, USA (US)
Kristina Voros, c/o Microsoft Corporation, One Microsoft Way, WA98052 REDMOND, USA (US)
Jonathan Aroner, c/o Microsoft Corporation, One Microsoft Way, WA98052 REDMOND, USA (US)
- (30) **Prioritet:** 2012.06.20, US, 29/425,171, 5
- (55) **Designavbildninger:**

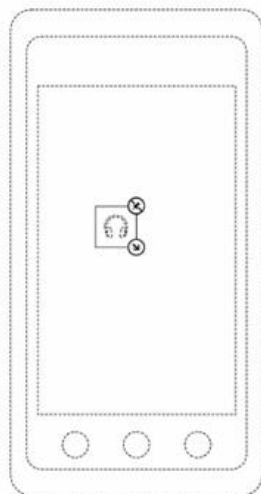

5.1

Design 6

- (54) **Produkt:** Visningsskjerm med brukergrensesnitt
- (51) **Klasse:** 14-04
- (72) **Designer:** Jeffrey G Arnold, c/o Microsoft Corp, One Microsoft Way, WA98052 REDMOND, USA (US)
Megan Donahue, c/o Microsoft Corporation, One Microsoft Way, WA98052 REDMOND, USA (US)
Chad Michael Roberts, c/o Microsoft Corporation, One Microsoft Way, WA98052 REDMOND, USA (US)
Rhoniell Villano Manlapaz, c/o Microsoft Corporation, One Microsoft Way, WA98052 REDMOND, USA (US)
Cara Lyn Tyler, c/o Microsoft Corporation, One Microsoft Way, WA98052 REDMOND, USA (US)
Andrea Michelle Simons, c/o Microsoft Corporation, One Microsoft Way, WA98052 REDMOND, USA (US)
Theodore Aaron Haberman, c/o Microsoft Corporation, One Microsoft Way, WA98052 REDMOND, USA (US)
Jeremy Monroe Bowen, c/o Microsoft Corporation, One Microsoft Way, WA98052 REDMOND, USA (US)
Lori Beth Kratzer, c/o Microsoft Corporation, One Microsoft Way, WA98052 REDMOND, USA (US)
Joseph Spencer King, c/o Microsoft Corporation, One Microsoft Way, WA98052 REDMOND, USA (US)
Josh Phillips, c/o Microsoft Corporation, One Microsoft Way, WA98052 REDMOND, USA (US)
Dawn Wilson, c/o Microsoft Corporation, One Microsoft Way, WA98052 REDMOND, USA (US)
Joyce S Chou, c/o Microsoft Corporation, One Microsoft Way, WA98052 REDMOND, USA (US)
Sogol Malekzadeh, c/o Microsoft Corporation, One Microsoft Way, WA98052 REDMOND, USA (US)
Jae Park, c/o Microsoft Corporation, One Microsoft Way, WA98052 REDMOND, USA (US)
Kristina Voros, c/o Microsoft Corporation, One Microsoft Way, WA98052 REDMOND, USA (US)
Jonathan Aroner, c/o Microsoft Corporation, One Microsoft Way, WA98052 REDMOND, USA (US)
- (30) **Prioritet:** 2012.06.20, US, 29/425,173, 6
- (55) **Designavbildninger:**

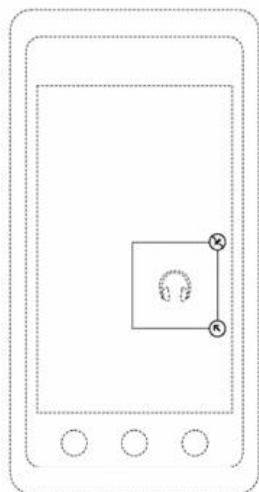

6.1

Design 7

- (54) **Produkt:** Visningsskjerm med brukergrensesnitt
- (51) **Klasse:** 14-04
- (72) **Designer:** Jeffrey G Arnold, c/o Microsoft Corp, One Microsoft Way, WA98052 REDMOND, USA (US)
Megan Donahue, c/o Microsoft Corporation, One Microsoft Way, WA98052 REDMOND, USA (US)
Chad Michael Roberts, c/o Microsoft Corporation, One Microsoft Way, WA98052 REDMOND, USA (US)
Rhoniell Villano Manlapaz, c/o Microsoft Corporation, One Microsoft Way, WA98052 REDMOND, USA (US)
Cara Lyn Tyler, c/o Microsoft Corporation, One Microsoft Way, WA98052 REDMOND, USA (US)
Andrea Michelle Simons, c/o Microsoft Corporation, One Microsoft Way, WA98052 REDMOND, USA (US)
Theodore Aaron Haberman, c/o Microsoft Corporation, One Microsoft Way, WA98052 REDMOND, USA (US)
Jeremy Monroe Bowen, c/o Microsoft Corporation, One Microsoft Way, WA98052 REDMOND, USA (US)
Lori Beth Kratzer, c/o Microsoft Corporation, One Microsoft Way, WA98052 REDMOND, USA (US)
Joseph Spencer King, c/o Microsoft Corporation, One Microsoft Way, WA98052 REDMOND, USA (US)
Josh Phillips, c/o Microsoft Corporation, One Microsoft Way, WA98052 REDMOND, USA (US)
Dawn Wilson, c/o Microsoft Corporation, One Microsoft Way, WA98052 REDMOND, USA (US)
Joyce S Chou, c/o Microsoft Corporation, One Microsoft Way, WA98052 REDMOND, USA (US)
Sogol Malekzadeh, c/o Microsoft Corporation, One Microsoft Way, WA98052 REDMOND, USA (US)
Jae Park, c/o Microsoft Corporation, One Microsoft Way, WA98052 REDMOND, USA (US)
Kristina Voros, c/o Microsoft Corporation, One Microsoft Way, WA98052 REDMOND, USA (US)
Jonathan Aroner, c/o Microsoft Corporation, One Microsoft Way, WA98052 REDMOND, USA (US)
- (30) **Prioritet:** 2012.06.20, US, 29/425,176, 7
- (55) **Designavbildninger:**

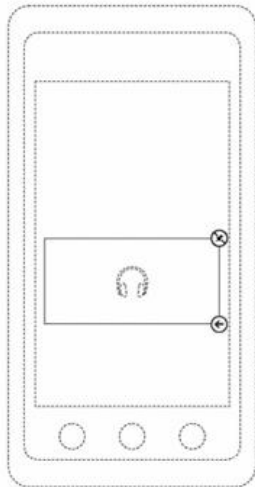

7.1

Design 8

- (54) **Produkt:** Ikon for visnings skjerm
- (51) **Klasse:** 14-04
- (72) **Designer:** Jeffrey G Arnold, c/o Microsoft Corp, One Microsoft Way, WA98052 REDMOND, USA (US)
Megan Donahue, c/o Microsoft Corporation, One Microsoft Way, WA98052 REDMOND, USA (US)
Chad Michael Roberts, c/o Microsoft Corporation, One Microsoft Way, WA98052 REDMOND, USA (US)
Rhoniell Villano Manlapaz, c/o Microsoft Corporation, One Microsoft Way, WA98052 REDMOND, USA (US)
Cara Lyn Tyler, c/o Microsoft Corporation, One Microsoft Way, WA98052 REDMOND, USA (US)
Andrea Michelle Simons, c/o Microsoft Corporation, One Microsoft Way, WA98052 REDMOND, USA (US)
Theodore Aaron Haberman, c/o Microsoft Corporation, One Microsoft Way, WA98052 REDMOND, USA (US)
Jeremy Monroe Bowen, c/o Microsoft Corporation, One Microsoft Way, WA98052 REDMOND, USA (US)
Lori Beth Kratzer, c/o Microsoft Corporation, One Microsoft Way, WA98052 REDMOND, USA (US)
Joseph Spencer King, c/o Microsoft Corporation, One Microsoft Way, WA98052 REDMOND, USA (US)
Josh Phillips, c/o Microsoft Corporation, One Microsoft Way, WA98052 REDMOND, USA (US)
Dawn Wilson, c/o Microsoft Corporation, One Microsoft Way, WA98052 REDMOND, USA (US)
Joyce S Chou, c/o Microsoft Corporation, One Microsoft Way, WA98052 REDMOND, USA (US)
Sogol Malekzadeh, c/o Microsoft Corporation, One Microsoft Way, WA98052 REDMOND, USA (US)
Jae Park, c/o Microsoft Corporation, One Microsoft Way, WA98052 REDMOND, USA (US)
Kristina Voros, c/o Microsoft Corporation, One Microsoft Way, WA98052 REDMOND, USA (US)
Jonathan Aroner, c/o Microsoft Corporation, One Microsoft Way, WA98052 REDMOND, USA (US)
- (30) **Prioritet:** 2012.06.20, US, 29/425,189, 8
- (55) **Designavbildninger:**



8.1

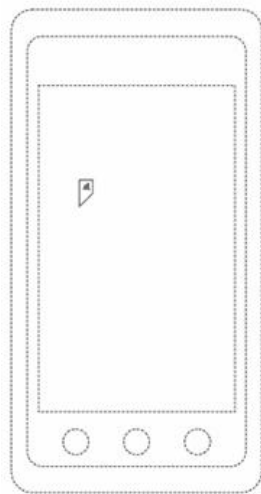

8.2

Design 9

- (54) **Produkt:** Visningsskjerm med brukergrensesnitt
(51) **Klasse:** 14-04
(72) **Designer:** Jeffrey G Arnold, c/o Microsoft Corp, One Microsoft Way, WA98052 REDMOND, USA (US)
Megan Donahue, c/o Microsoft Corporation, One Microsoft Way, WA98052 REDMOND, USA (US)
Chad Michael Roberts, c/o Microsoft Corporation, One Microsoft Way, WA98052 REDMOND, USA (US)
Rhoniell Villano Manlapaz, c/o Microsoft Corporation, One Microsoft Way, WA98052 REDMOND, USA (US)
Cara Lyn Tyler, c/o Microsoft Corporation, One Microsoft Way, WA98052 REDMOND, USA (US)
Andrea Michelle Simons, c/o Microsoft Corporation, One Microsoft Way, WA98052 REDMOND, USA (US)
Theodore Aaron Haberman, c/o Microsoft Corporation, One Microsoft Way, WA98052 REDMOND, USA (US)
Jeremy Monroe Bowen, c/o Microsoft Corporation, One Microsoft Way, WA98052 REDMOND, USA (US)
Lori Beth Kratzer, c/o Microsoft Corporation, One Microsoft Way, WA98052 REDMOND, USA (US)
Joseph Spencer King, c/o Microsoft Corporation, One Microsoft Way, WA98052 REDMOND, USA (US)
Josh Phillips, c/o Microsoft Corporation, One Microsoft Way, WA98052 REDMOND, USA (US)
Dawn Wilson, c/o Microsoft Corporation, One Microsoft Way, WA98052 REDMOND, USA (US)
Joyce S Chou, c/o Microsoft Corporation, One Microsoft Way, WA98052 REDMOND, USA (US)
Sogol Malekzadeh, c/o Microsoft Corporation, One Microsoft Way, WA98052 REDMOND, USA (US)
Jae Park, c/o Microsoft Corporation, One Microsoft Way, WA98052 REDMOND, USA (US)
Kristina Voros, c/o Microsoft Corporation, One Microsoft Way, WA98052 REDMOND, USA (US)
Jonathan Aroner, c/o Microsoft Corporation, One Microsoft Way, WA98052 REDMOND, USA (US)

(55) **Designavbildninger:**

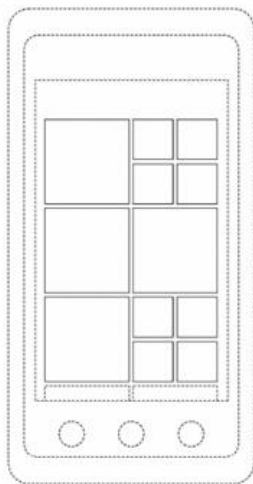

9.1

Design 10

- (54) **Produkt:** Visningsskjerm med brukergrensesnitt
(51) **Klasse:** 14-04
(72) **Designer:** Jeffrey G Arnold, c/o Microsoft Corp, One Microsoft Way, WA98052 REDMOND, USA (US)
Megan Donahue, c/o Microsoft Corporation, One Microsoft Way, WA98052 REDMOND, USA (US)
Chad Michael Roberts, c/o Microsoft Corporation, One Microsoft Way, WA98052 REDMOND, USA (US)
Rhoniell Villano Manlapaz, c/o Microsoft Corporation, One Microsoft Way, WA98052 REDMOND, USA (US)
Cara Lyn Tyler, c/o Microsoft Corporation, One Microsoft Way, WA98052 REDMOND, USA (US)
Andrea Michelle Simons, c/o Microsoft Corporation, One Microsoft Way, WA98052 REDMOND, USA (US)
Theodore Aaron Haberman, c/o Microsoft Corporation, One Microsoft Way, WA98052 REDMOND, USA (US)
Jeremy Monroe Bowen, c/o Microsoft Corporation, One Microsoft Way, WA98052 REDMOND, USA (US)
Lori Beth Kratzer, c/o Microsoft Corporation, One Microsoft Way, WA98052 REDMOND, USA (US)
Joseph Spencer King, c/o Microsoft Corporation, One Microsoft Way, WA98052 REDMOND, USA (US)
Josh Phillips, c/o Microsoft Corporation, One Microsoft Way, WA98052 REDMOND, USA (US)
Dawn Wilson, c/o Microsoft Corporation, One Microsoft Way, WA98052 REDMOND, USA (US)
Joyce S Chou, c/o Microsoft Corporation, One Microsoft Way, WA98052 REDMOND, USA (US)
Sogol Malekzadeh, c/o Microsoft Corporation, One Microsoft Way, WA98052 REDMOND, USA (US)
Jae Park, c/o Microsoft Corporation, One Microsoft Way, WA98052 REDMOND, USA (US)
Kristina Voros, c/o Microsoft Corporation, One Microsoft Way, WA98052 REDMOND, USA (US)
Jonathan Aroner, c/o Microsoft Corporation, One Microsoft Way, WA98052 REDMOND, USA (US)

(55) **Designavbildninger:**

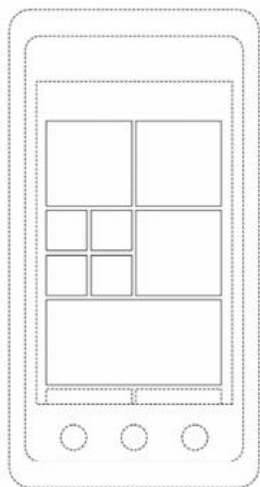

10.1

Design 11

- (54) **Produkt:** Visningsskjerm med brukergrensesnitt
(51) **Klasse:** 14-04
(72) **Designer:** Jeffrey G Arnold, c/o Microsoft Corp, One Microsoft Way, WA98052 REDMOND, USA (US)
Megan Donahue, c/o Microsoft Corporation, One Microsoft Way, WA98052 REDMOND, USA (US)
Chad Michael Roberts, c/o Microsoft Corporation, One Microsoft Way, WA98052 REDMOND, USA (US)
Rhoniell Villano Manlapaz, c/o Microsoft Corporation, One Microsoft Way, WA98052 REDMOND, USA (US)
Cara Lyn Tyler, c/o Microsoft Corporation, One Microsoft Way, WA98052 REDMOND, USA (US)
Andrea Michelle Simons, c/o Microsoft Corporation, One Microsoft Way, WA98052 REDMOND, USA (US)
Theodore Aaron Haberman, c/o Microsoft Corporation, One Microsoft Way, WA98052 REDMOND, USA (US)
Jeremy Monroe Bowen, c/o Microsoft Corporation, One Microsoft Way, WA98052 REDMOND, USA (US)
Lori Beth Kratzer, c/o Microsoft Corporation, One Microsoft Way, WA98052 REDMOND, USA (US)
Joseph Spencer King, c/o Microsoft Corporation, One Microsoft Way, WA98052 REDMOND, USA (US)
Josh Phillips, c/o Microsoft Corporation, One Microsoft Way, WA98052 REDMOND, USA (US)
Dawn Wilson, c/o Microsoft Corporation, One Microsoft Way, WA98052 REDMOND, USA (US)
Joyce S Chou, c/o Microsoft Corporation, One Microsoft Way, WA98052 REDMOND, USA (US)
Sogol Malekzadeh, c/o Microsoft Corporation, One Microsoft Way, WA98052 REDMOND, USA (US)
Jae Park, c/o Microsoft Corporation, One Microsoft Way, WA98052 REDMOND, USA (US)
Kristina Voros, c/o Microsoft Corporation, One Microsoft Way, WA98052 REDMOND, USA (US)
Jonathan Aroner, c/o Microsoft Corporation, One Microsoft Way, WA98052 REDMOND, USA (US)

(55) **Designavbildninger:**

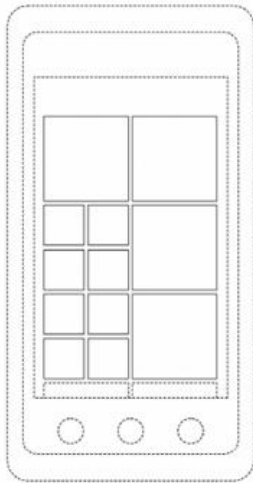

11.1

Design 12

- (54) **Produkt:** Visningsskjerm med brukergrensesnitt
(51) **Klasse:** 14-04
(72) **Designer:** Jeffrey G Arnold, c/o Microsoft Corp, One Microsoft Way, WA98052 REDMOND, USA (US)
Megan Donahue, c/o Microsoft Corporation, One Microsoft Way, WA98052 REDMOND, USA (US)
Chad Michael Roberts, c/o Microsoft Corporation, One Microsoft Way, WA98052 REDMOND, USA (US)
Rhoniell Villano Manlapaz, c/o Microsoft Corporation, One Microsoft Way, WA98052 REDMOND, USA (US)
Cara Lyn Tyler, c/o Microsoft Corporation, One Microsoft Way, WA98052 REDMOND, USA (US)
Andrea Michelle Simons, c/o Microsoft Corporation, One Microsoft Way, WA98052 REDMOND, USA (US)
Theodore Aaron Haberman, c/o Microsoft Corporation, One Microsoft Way, WA98052 REDMOND, USA (US)
Jeremy Monroe Bowen, c/o Microsoft Corporation, One Microsoft Way, WA98052 REDMOND, USA (US)
Lori Beth Kratzer, c/o Microsoft Corporation, One Microsoft Way, WA98052 REDMOND, USA (US)
Joseph Spencer King, c/o Microsoft Corporation, One Microsoft Way, WA98052 REDMOND, USA (US)
Josh Phillips, c/o Microsoft Corporation, One Microsoft Way, WA98052 REDMOND, USA (US)
Dawn Wilson, c/o Microsoft Corporation, One Microsoft Way, WA98052 REDMOND, USA (US)
Joyce S Chou, c/o Microsoft Corporation, One Microsoft Way, WA98052 REDMOND, USA (US)
Sogol Malekzadeh, c/o Microsoft Corporation, One Microsoft Way, WA98052 REDMOND, USA (US)
Jae Park, c/o Microsoft Corporation, One Microsoft Way, WA98052 REDMOND, USA (US)
Kristina Voros, c/o Microsoft Corporation, One Microsoft Way, WA98052 REDMOND, USA (US)
Jonathan Aroner, c/o Microsoft Corporation, One Microsoft Way, WA98052 REDMOND, USA (US)

(55) **Designavbildninger:**

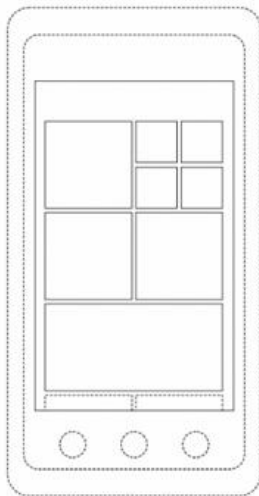

12.1

Design 13

- (54) **Produkt:** Visningsskjerm med brukergrensesnitt
14-04
- (51) **Klasse:** Jeffrey G Arnold, c/o Microsoft Corp, One Microsoft Way, WA98052 REDMOND, USA (US)
Megan Donahue, c/o Microsoft Corporation, One Microsoft Way, WA98052 REDMOND, USA (US)
- (72) **Designer:** Chad Michael Roberts, c/o Microsoft Corporation, One Microsoft Way, WA98052 REDMOND, USA (US)
Rhoniell Villano Manlapaz, c/o Microsoft Corporation, One Microsoft Way, WA98052 REDMOND, USA (US)
Cara Lyn Tyler, c/o Microsoft Corporation, One Microsoft Way, WA98052 REDMOND, USA (US)
Andrea Michelle Simons, c/o Microsoft Corporation, One Microsoft Way, WA98052 REDMOND, USA (US)
Theodore Aaron Haberman, c/o Microsoft Corporation, One Microsoft Way, WA98052 REDMOND, USA (US)
Jeremy Monroe Bowen, c/o Microsoft Corporation, One Microsoft Way, WA98052 REDMOND, USA (US)
Lori Beth Kratzer, c/o Microsoft Corporation, One Microsoft Way, WA98052 REDMOND, USA (US)
Joseph Spencer King, c/o Microsoft Corporation, One Microsoft Way, WA98052 REDMOND, USA (US)
Josh Phillips, c/o Microsoft Corporation, One Microsoft Way, WA98052 REDMOND, USA (US)
Dawn Wilson, c/o Microsoft Corporation, One Microsoft Way, WA98052 REDMOND, USA (US)
Joyce S Chou, c/o Microsoft Corporation, One Microsoft Way, WA98052 REDMOND, USA (US)
Sogol Malekzadeh, c/o Microsoft Corporation, One Microsoft Way, WA98052 REDMOND, USA (US)
Jae Park, c/o Microsoft Corporation, One Microsoft Way, WA98052 REDMOND, USA (US)
Kristina Voros, c/o Microsoft Corporation, One Microsoft Way, WA98052 REDMOND, USA (US)
Jonathan Aroner, c/o Microsoft Corporation, One Microsoft Way, WA98052 REDMOND, USA (US)

(55) **Designavbildninger:**

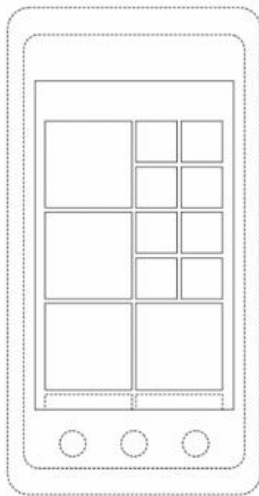

13.1

Design 14

- (54) **Produkt:** Visningsskjerm med brukergrensesnitt
- (51) **Klasse:** 14-04
- (72) **Designer:** Jeffrey G Arnold, c/o Microsoft Corp, One Microsoft Way, WA98052 REDMOND, USA (US)
Megan Donahue, c/o Microsoft Corporation, One Microsoft Way, WA98052 REDMOND, USA (US)
Chad Michael Roberts, c/o Microsoft Corporation, One Microsoft Way, WA98052 REDMOND, USA (US)
Rhoniell Villano Manlapaz, c/o Microsoft Corporation, One Microsoft Way, WA98052 REDMOND, USA (US)
Cara Lyn Tyler, c/o Microsoft Corporation, One Microsoft Way, WA98052 REDMOND, USA (US)
Andrea Michelle Simons, c/o Microsoft Corporation, One Microsoft Way, WA98052 REDMOND, USA (US)
Theodore Aaron Haberman, c/o Microsoft Corporation, One Microsoft Way, WA98052 REDMOND, USA (US)
Jeremy Monroe Bowen, c/o Microsoft Corporation, One Microsoft Way, WA98052 REDMOND, USA (US)
Lori Beth Kratzer, c/o Microsoft Corporation, One Microsoft Way, WA98052 REDMOND, USA (US)
Joseph Spencer King, c/o Microsoft Corporation, One Microsoft Way, WA98052 REDMOND, USA (US)
Josh Phillips, c/o Microsoft Corporation, One Microsoft Way, WA98052 REDMOND, USA (US)
Dawn Wilson, c/o Microsoft Corporation, One Microsoft Way, WA98052 REDMOND, USA (US)
Joyce S Chou, c/o Microsoft Corporation, One Microsoft Way, WA98052 REDMOND, USA (US)
Sogol Malekzadeh, c/o Microsoft Corporation, One Microsoft Way, WA98052 REDMOND, USA (US)
Jae Park, c/o Microsoft Corporation, One Microsoft Way, WA98052 REDMOND, USA (US)
Kristina Voros, c/o Microsoft Corporation, One Microsoft Way, WA98052 REDMOND, USA (US)
Jonathan Aroner, c/o Microsoft Corporation, One Microsoft Way, WA98052 REDMOND, USA (US)

(55) **Designavbildninger:**

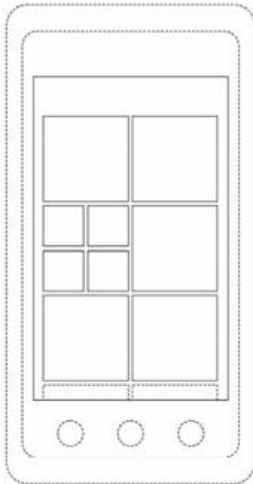

14.1

Design 15

- (54) **Produkt:** Visningsskjerm med brukergrensesnitt
14-04
- (51) **Klasse:** Jeffrey G Arnold, c/o Microsoft Corp, One Microsoft Way, WA98052 REDMOND, USA (US)
Megan Donahue, c/o Microsoft Corporation, One Microsoft Way, WA98052 REDMOND, USA (US)
- (72) **Designer:** Chad Michael Roberts, c/o Microsoft Corporation, One Microsoft Way, WA98052 REDMOND, USA (US)
Rhoniell Villano Manlapaz, c/o Microsoft Corporation, One Microsoft Way, WA98052 REDMOND, USA (US)
Cara Lyn Tyler, c/o Microsoft Corporation, One Microsoft Way, WA98052 REDMOND, USA (US)
Andrea Michelle Simons, c/o Microsoft Corporation, One Microsoft Way, WA98052 REDMOND, USA (US)
Theodore Aaron Haberman, c/o Microsoft Corporation, One Microsoft Way, WA98052 REDMOND, USA (US)
Jeremy Monroe Bowen, c/o Microsoft Corporation, One Microsoft Way, WA98052 REDMOND, USA (US)
Lori Beth Kratzer, c/o Microsoft Corporation, One Microsoft Way, WA98052 REDMOND, USA (US)
Joseph Spencer King, c/o Microsoft Corporation, One Microsoft Way, WA98052 REDMOND, USA (US)
Josh Phillips, c/o Microsoft Corporation, One Microsoft Way, WA98052 REDMOND, USA (US)
Dawn Wilson, c/o Microsoft Corporation, One Microsoft Way, WA98052 REDMOND, USA (US)
Joyce S Chou, c/o Microsoft Corporation, One Microsoft Way, WA98052 REDMOND, USA (US)
Sogol Malekzadeh, c/o Microsoft Corporation, One Microsoft Way, WA98052 REDMOND, USA (US)
Jae Park, c/o Microsoft Corporation, One Microsoft Way, WA98052 REDMOND, USA (US)
Kristina Voros, c/o Microsoft Corporation, One Microsoft Way, WA98052 REDMOND, USA (US)
Jonathan Aroner, c/o Microsoft Corporation, One Microsoft Way, WA98052 REDMOND, USA (US)

(55) **Designavbildninger:**

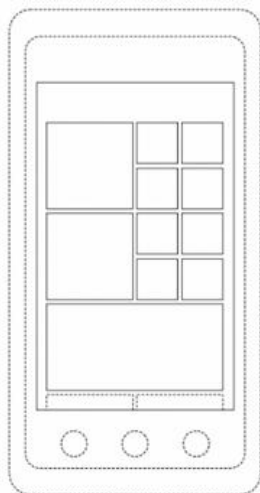

15.1

Design 16

- (54) **Produkt:** Ikon for visnings skjerm
(51) **Klasse:** 14-04
(72) **Designer:** Jeffrey G Arnold, c/o Microsoft Corp, One Microsoft Way, WA98052 REDMOND, USA (US)
Megan Donahue, c/o Microsoft Corporation, One Microsoft Way, WA98052 REDMOND, USA (US)
Chad Michael Roberts, c/o Microsoft Corporation, One Microsoft Way, WA98052 REDMOND, USA (US)
Rhoniell Villano Manlapaz, c/o Microsoft Corporation, One Microsoft Way, WA98052 REDMOND, USA (US)
Cara Lyn Tyler, c/o Microsoft Corporation, One Microsoft Way, WA98052 REDMOND, USA (US)
Andrea Michelle Simons, c/o Microsoft Corporation, One Microsoft Way, WA98052 REDMOND, USA (US)
Theodore Aaron Haberman, c/o Microsoft Corporation, One Microsoft Way, WA98052 REDMOND, USA (US)
Jeremy Monroe Bowen, c/o Microsoft Corporation, One Microsoft Way, WA98052 REDMOND, USA (US)
Lori Beth Kratzer, c/o Microsoft Corporation, One Microsoft Way, WA98052 REDMOND, USA (US)
Joseph Spencer King, c/o Microsoft Corporation, One Microsoft Way, WA98052 REDMOND, USA (US)
Josh Phillips, c/o Microsoft Corporation, One Microsoft Way, WA98052 REDMOND, USA (US)
Dawn Wilson, c/o Microsoft Corporation, One Microsoft Way, WA98052 REDMOND, USA (US)
Joyce S Chou, c/o Microsoft Corporation, One Microsoft Way, WA98052 REDMOND, USA (US)
Sogol Malekzadeh, c/o Microsoft Corporation, One Microsoft Way, WA98052 REDMOND, USA (US)
Jae Park, c/o Microsoft Corporation, One Microsoft Way, WA98052 REDMOND, USA (US)
Kristina Voros, c/o Microsoft Corporation, One Microsoft Way, WA98052 REDMOND, USA (US)
Jonathan Aroner, c/o Microsoft Corporation, One Microsoft Way, WA98052 REDMOND, USA (US)
- (30) **Prioritet:** 2012.06.20, US, 29/425,215, 3, 16
(55) **Designavbildninger:**

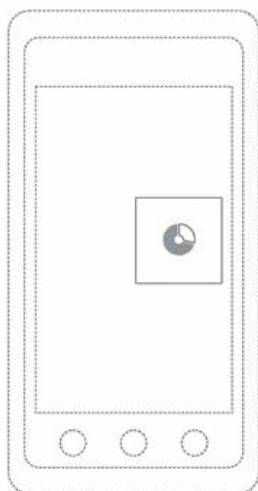

16.1

(11)	Reg.nr.:	084000
(21)	Søkn.nr.:	20130331
(22)	Inngitt:	2013.03.27
(24)	Løpedag:	2013.03.27
(43)	Allm. tilgj.:	2013.03.27
(15)	Registrert:	2013.06.14
(45)	Kunngjort:	2013.07.08
(18)	Reg. gjelder til:	2018.03.27
(74)	Fullmektig:	Acapo AS, Postboks 1880 Nordnes, 5817 BERGEN, Norge
(73)	Innehaber:	Alejandro de Viveiros Ortiz, ITC Empreendimentos e Participacoes, Avenida Ibirapuera, 2331, Conjunto 32, Torre II, Indianopolis, BR-04028-002 SAN-PAULO, Brasil

Design 1

(54)	Produkt:	Spilleautomat
(51)	Klasse:	21-03
(72)	Designert:	Alejandro De Viveiros Ortiz, ITC EMPREENDIMENTOS E PARTICIPACOES, AVENIDA IBIRAPUERA, 2331, Conjunto 32, Torre II, Indianopolis, 04028-002 SAO PAULO, Brasil (BR)
(55)	Designavbildninger:	

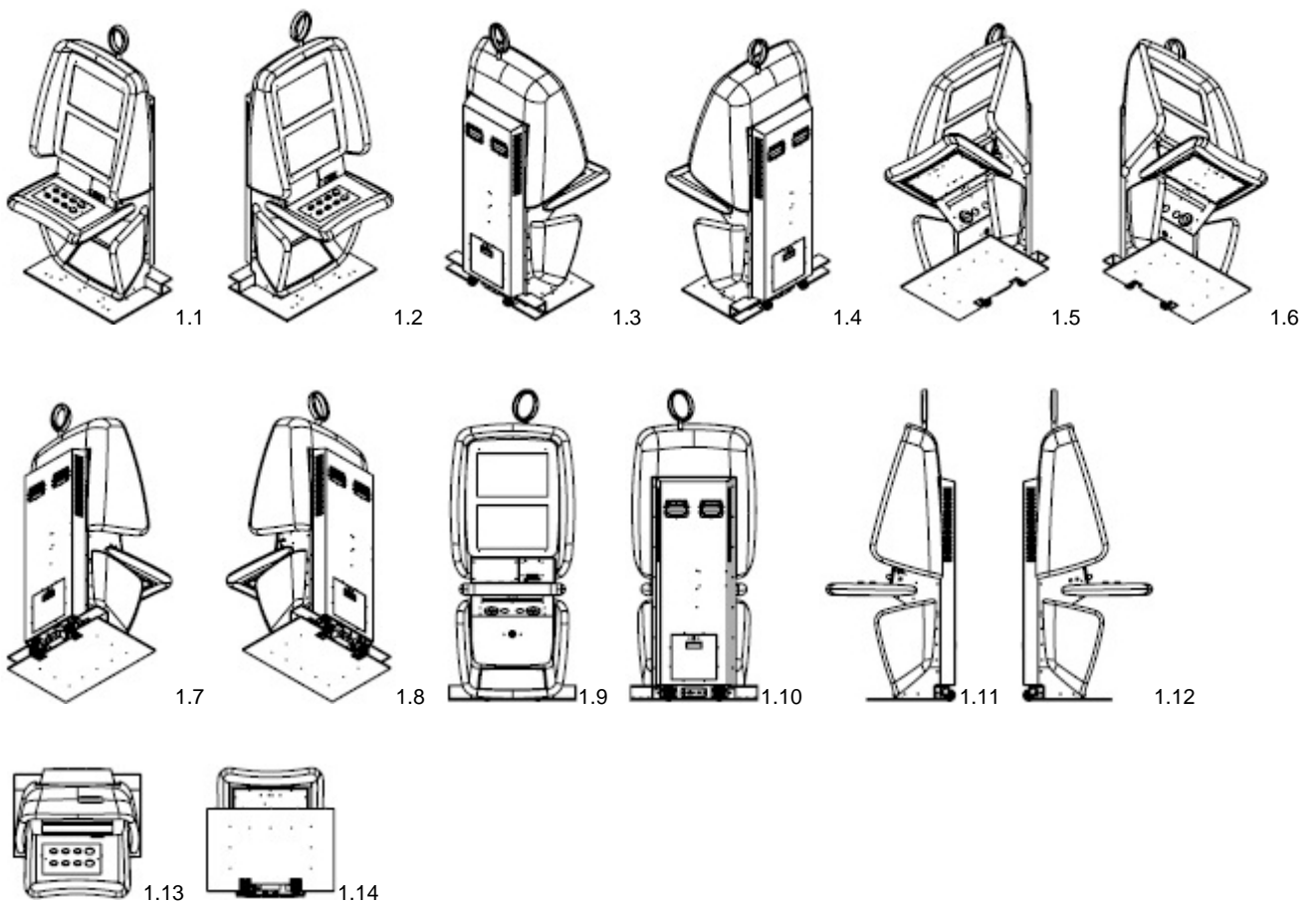

(11)	Reg.nr.:	084001
(21)	Søkn.nr.:	20130379
(22)	Inngitt:	2013.04.24
(24)	Løpedag:	2013.04.24
(43)	Allm. tilgj.:	2013.04.24
(15)	Registrert:	2013.06.14
(45)	Kunngjort:	2013.07.08
(18)	Reg. gjelder til:	2018.04.24
(74)	Fullmektig:	Oslo Patentkontor AS, Postboks 7007 Majorstua , 0306 OSLO, Norge
(73)	Innehaver:	Pegasus Trading as, Nordre Røråsen 4, 3720 SKIEN, Norge
(50)	Anmerkninger:	Registreringne gjelder samregistrering.

Design 1

(54)	Produkt:	Kakespade
(51)	Klasse:	07-06
(72)	Designer:	Svein Levi Sekse, Nordre Røråsen 5, 3720 SKIEN
(30)	Prioritet:	2013.04.17, NO, 20130361, 1
(55)	Designavbildninger:	



1.1



1.2



1.3



1.4

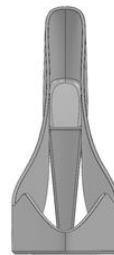

1.5



1.6

Design 2

- (54) **Produkt:** Kakespade
 (51) **Klasse:** 07-06
 (72) **Designer:** Svein Levi Sekse, Nordre Røråsen 5, 3720 SKIEN
 (30) **Prioritet:** 2013.04.17, NO, 20130362, 2
 (55) **Designavbildninger:**



2.1



2.2



2.3



2.4

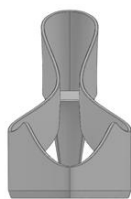

2.5



2.6

- (11) **Reg.nr.:** 084002
 (21) **Søkn.nr.:** 20130460
 (22) **Inngitt:** 2013.04.26
 (24) **Løpedag:** 2013.04.26
 (43) **Allm. tilgj.:** 2013.04.26
 (15) **Registrert:** 2013.06.18
 (45) **Kunngjort:** 2013.07.08
 (18) **Reg. gjelder til:** 2018.04.26
 (74) **Fullmektig:** Zacco Norway AS, Postboks 2003 Vika, 0125 OSLO, Norge
 (73) **Innehaver:** Eppendorf AG, Barkhausenweg 1, DE-22339 HAMBURG, Tyskland
 (50) **Anmerkninger:** Designen er i farger.

Design 1

- (54) **Produkt:** Trykksak/trykt reklamemateriale, klasse 19-08; Skilt/reklameutstyr, klasse 20-03; Ornamment, klasse 32-00
 (51) **Klasse:** 19-08
 20-03
 32-00
 (72) **Designer:** Ralph Ehinger, Seestrasse 356, 8038 ZÜRICH, Sveits (CH)
 (30) **Prioritet:** 2012.11.01, DE, 40 2012 005 034, 1
 (50) **Anmerkning:** Designen er i farger.
 (55) **Designavbildninger:**



1.1

(11)	Reg.nr.:	084003
(21)	Søkn.nr.:	20130253
(22)	Inngitt:	2013.03.18
(24)	Løpedag:	2013.03.18
(43)	Allm. tilgj.:	2013.03.18
(15)	Registrert:	2013.06.19
(45)	Kunngjort:	2013.07.08
(18)	Reg. gjelder til:	2018.03.18
(74)	Fullmektig:	Zacco Norway AS, Postboks 2003 Vika, 0125 OSLO, Norge
(73)	Innehaver:	Honda Motor Co Ltd, 1-1, Minami-Aoyama 2-Chome, Minato-ku, JP-107-0062 TOKYO, Japan
(50)	Anmerkninger:	Det er foretatt supplerende undersøkelse.

Design 1

(54)	Produkt:	Del av forbrenningsmotor
(51)	Klasse:	15-01
(72)	Designert:	Masato Fujiwara, c/o Kabushiki Kaisha Honda Gijutsu Kenkyusho, 4-1, Chuo 1-chome, 351-0113 WAKO-SHI, SAITAMA, Japan (JP)
(30)	Prioritet:	2012.09.27, JP, 2012-023513
(50)	Anmerkning:	Det er foretatt supplerende undersøkelse.
(55)	Designavbildninger:	

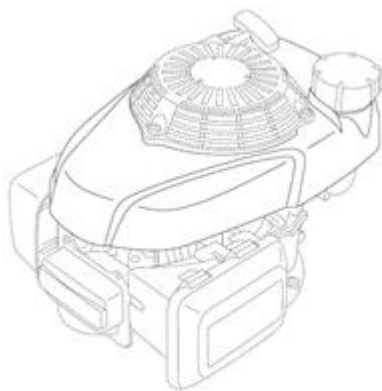

1.1

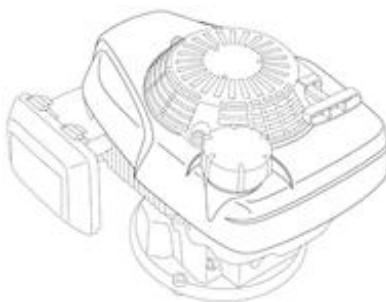

1.2

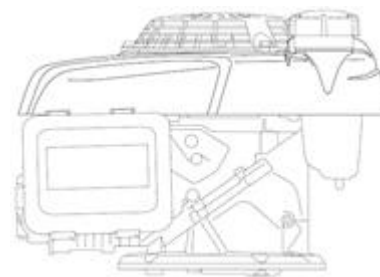

1.3

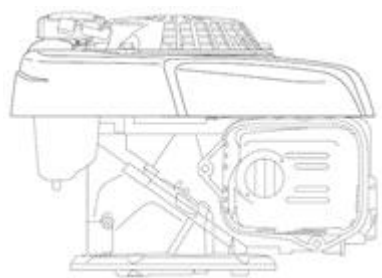

1.4

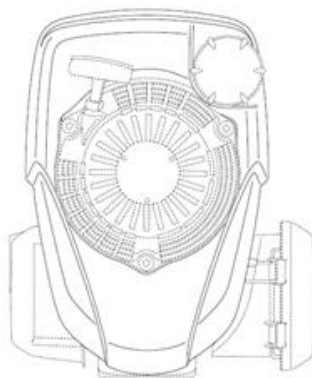

1.5

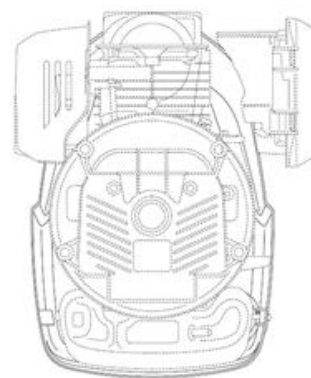

1.6

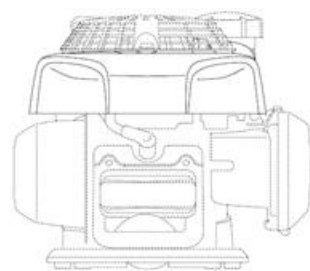

1.7

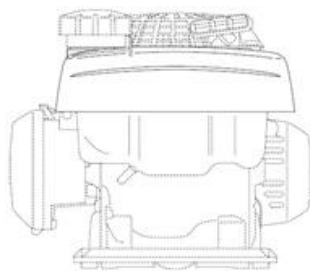

1.8

(11)	Reg.nr.:	084004
(21)	Søkn.nr.:	20130111
(22)	Inngitt:	2013.01.22
(24)	Løpedag:	2013.01.22
(43)	Allm. tilgj.:	2013.01.22
(15)	Registrert:	2013.06.19
(45)	Kunngjort:	2013.07.08
(18)	Reg. gjelder til:	2018.01.22
(73)	Innehaver:	Annette Ostermark, Vårljungstigen 49, SE-55632 JÖNKÖPING, Sverige

Design 1

(54)	Produkt:	Tanntrådholder
(51)	Klasse:	24-99
(72)	Designer:	Annette Ostermark, Vårljungstigen 49, 55632 JÖNKÖPING, Sverige (SE) Emil Ostermark, Vårljungstigen 49, 55632 JÖNKÖPING, Sverige (SE)
(30)	Prioritet:	2012.11.20, EM, 001351993
(55)	Designavbildninger:	

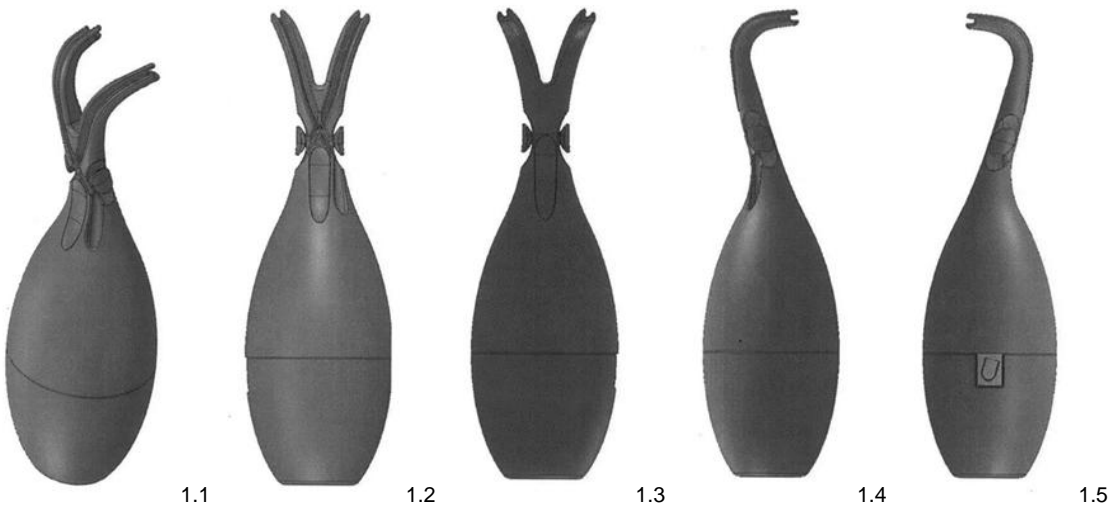

(11)	Reg.nr.:	084005
(21)	Søkn.nr.:	20130336
(22)	Inngitt:	2013.04.03
(24)	Løpedag:	2013.04.03
(43)	Allm. tilgj.:	2013.04.05
(15)	Registrert:	2013.06.19
(45)	Kunngjort:	2013.07.08
(18)	Reg. gjelder til:	2018.04.03
(74)	Fullmektig:	Curo AS, Industriveien 53, 7080 HEIMDAL, Norge
(73)	Innehaver:	Scanmaskin Sverige AB, Box 187, SE-43722 LINDOME, Sverige
(50)	Anmerkninger:	Registreringen gjelder samregistrering.

Design 1

(54)	Produkt:	Slipeverktøy
(51)	Klasse:	08-05
(72)	Designer:	Paulo Bergstrand, Rådjursvägen 1, 42941 SÄRÖ, Sverige (SE)
(30)	Prioritet:	2012.10.05, EM, 002114124
(55)	Designavbildninger:	

**Design 2**

(54)	Produkt:	Slipeverktøy
(51)	Klasse:	08-05
(72)	Designer:	Paulo Bergstrand, Rådjursvägen 1, 42941 SÄRÖ, Sverige (SE)
(30)	Prioritet:	2012.10.05, EM, 002114124
(55)	Designavbildninger:	



Design 3

(54)	Produkt:	Slipeverktøy
(51)	Klasse:	08-05
(72)	Designer:	Paulo Bergstrand, Rådjursvägen 1, 42941 SÄRÖ, Sverige (SE)
(30)	Prioritet:	2012.10.05, EM, 002114124
(55)	Designavbildninger:	



3.1



3.2

Design 4

(54)	Produkt:	Slipeverktøy
(51)	Klasse:	08-05
(72)	Designer:	Paulo Bergstrand, Rådjursvägen 1, 42941 SÄRÖ, Sverige (SE)
(30)	Prioritet:	2012.10.05, EM, 002114124
(55)	Designavbildninger:	



4.1



4.2

Design 5

- (54) **Produkt:** Del av verktøyfeste for slipeverktøy
(51) **Klasse:** 08-05
(72) **Designer:** Paulo Bergstrand, Rådjursvägen 1, 42941 SÄRÖ, Sverige (SE)
(30) **Prioritet:** 2012.10.05, EM, 002114124
(55) **Designavbildninger:**



5.1

Design 6

- (54) **Produkt:** Del av verktøyfeste for slipeverktøy
(51) **Klasse:** 08-05
(72) **Designer:** Paulo Bergstrand, Rådjursvägen 1, 42941 SÄRÖ, Sverige (SE)
(30) **Prioritet:** 2012.10.05, EM, 002114124
(55) **Designavbildninger:**



6.1

(11)	Reg.nr.:	084006
(21)	Søkn.nr.:	20130004
(22)	Inngitt:	2013.01.04
(24)	Løpedag:	2013.01.04
(43)	Allm. tilgj.:	2013.06.19
(15)	Registrert:	2013.06.19
(45)	Kunngjort:	2013.07.08
(18)	Reg. gjelder til:	2018.01.04
(74)	Fullmektig:	Norsk Patentbyrå AS, Postboks 1204 Vika, 0110 OSLO, Norge
(73)	Innehaver:	Kongsberg Esco AS, Postboks 85, 3602 KONGSBERG, Norge
(50)	Anmerkninger:	Registreringen gjelder samregistrering.

Design 1

(54)	Produkt:	Fot til konsoll for tilkobling av ventil-t, flensekryss og flense-t
(51)	Klasse:	23-01
(72)	Designer:	Kongsberg Esco AS, Postboks 85, 3602 KONGSBERG
(55)	Designavbildninger:	

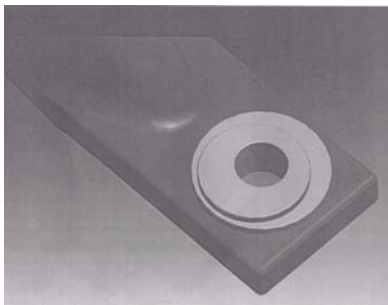

1.1

Design 2

(54)	Produkt:	Fot til konsoll for tilkobling av ventil-t, flensekryss og flense-t
(51)	Klasse:	23-01
(72)	Designer:	Kongsberg Esco AS, Postboks 85, 3602 KONGSBERG
(55)	Designavbildninger:	

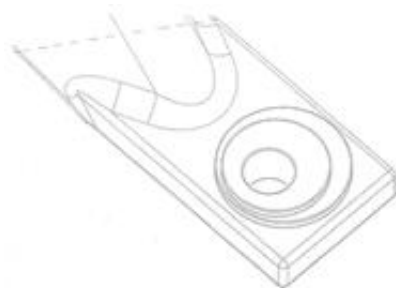

2.1

(11)	Reg.nr.:	084007
(21)	Søkn.nr.:	20130353
(22)	Inngitt:	2013.04.08
(24)	Løpedag:	2013.04.08
(43)	Allm. tilgj.:	2013.04.08
(15)	Registrert:	2013.06.19
(45)	Kunngjort:	2013.07.08
(18)	Reg. gjelder til:	2018.04.08
(73)	Innehaver:	Vigdis Antonie Olaussen, Sorgenfrigt. 38B, 0365 OSLO, Norge

Design 1

(54)	Produkt:	Veggkonstruksjon for barn med seter og klatremuligheter.
(51)	Klasse:	06-01
(72)	Designer:	Vigdis Antonie Olaussen, Sorgenfrigt. 38B, 0365 OSLO
(55)	Designavbildninger:	

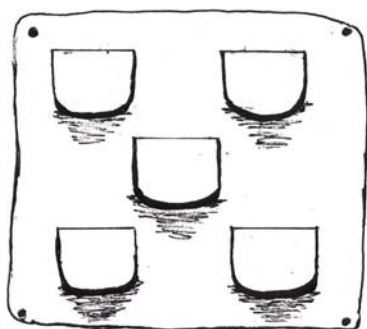

1.1

(11)	Reg.nr.:	084008
(21)	Søkn.nr.:	20130355
(22)	Inngitt:	2013.04.08
(24)	Løpedag:	2013.04.08
(43)	Allm. tilgj.:	2013.04.08
(15)	Registrert:	2013.06.19
(45)	Kunngjort:	2013.07.08
(18)	Reg. gjelder til:	2018.04.08
(73)	Innehaver:	Vigdis Antonie Olaussen, Sorgenfrigt. 38B, 0365 OSLO, Norge

Design 1

(54)	Produkt:	Sammenleggbar barnestol med flere sitteplasser
(51)	Klasse:	06-01
(72)	Designer:	Vigdis Antonie Olaussen, Sorgenfrigt. 38B, 0365 OSLO
(55)	Designavbildninger:	

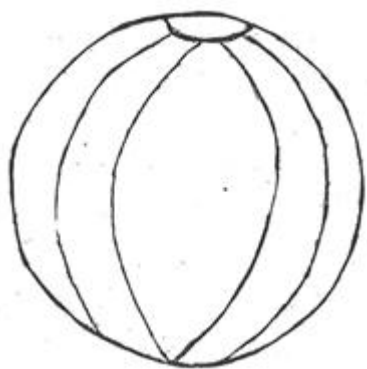

1.1

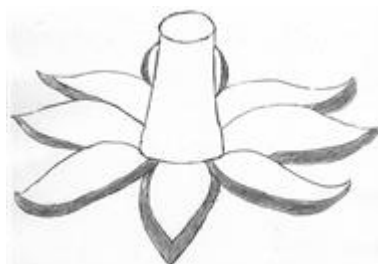

1.2

- (11) **Reg.nr.:** 084009
(21) **Søkn.nr.:** 20130340
(22) **Inngitt:** 2013.04.05
(24) **Løpedag:** 2013.04.05
(43) **Allm. tilgj.:** 2013.04.05
(15) **Registrert:** 2013.06.19
(45) **Kunngjort:** 2013.07.08
(18) **Reg. gjelder til:** 2018.04.05
(74) **Fullmektig:** Zacco Norway AS, Postboks 2003 Vika, 0125 OSLO, Norge
(73) **Innehaver:** Manitowoc Foodservice Companies LLC, 2400 South 44th Street, US-WI542200 MANITOWOC, USA
(50) **Anmerkninger:** Registreringen gjelder samregistrering.

Design 1

- (54) **Produkt:** Del til stavmikser
(51) **Klasse:** 31-00
(72) **Designer:** Derek Morrison, 10855 Peoria, IL60643 CHICAGO, USA (US)
Paul Hanniffy, 4300 Crowne Springs Drive, #207, KY40241 LOUISVILLE, USA (US)
Bill Teller, 2100 Future Drive, IN47172 SELLERSBURG, USA (US)
Gregory Alan Meyer, 8119 Stacy Road, IN CHARLESTOWN, USA (US)
(30) **Prioritet:** 2013.01.23, US, 29/443,869
(55) **Designavbildninger:**

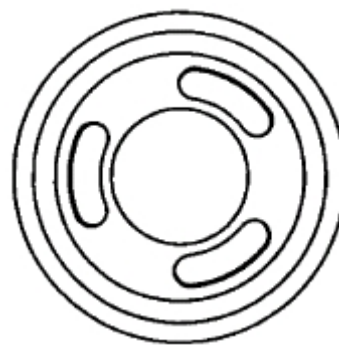
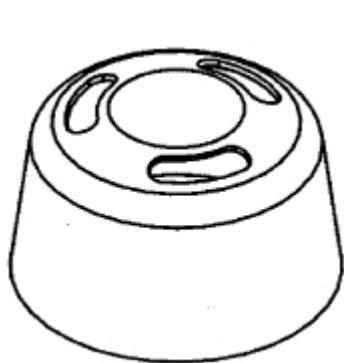

Design 2

- (54) **Produkt:** Del til stavmikser
(51) **Klasse:** 31-00
(72) **Designer:** Derek Morrison, 10855 Peoria, IL60643 CHICAGO, USA (US)
Paul Hanniffy, 4300 Crowne Springs Drive, #207, KY40241 LOUISVILLE, USA (US)
Bill Teller, 2100 Future Drive, IN47172 SELLERSBURG, USA (US)
Gregory Alan Meyer, 8119 Stacy Road, IN CHARLESTOWN, USA (US)
2013.01.23, US, 29/443,869
- (30) **Prioritet:**
(55) **Designavbildninger:**

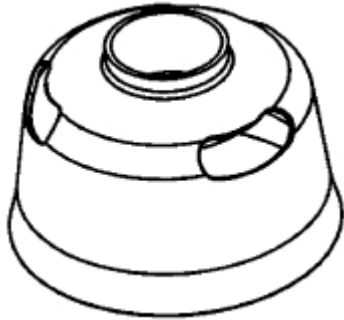

2.1

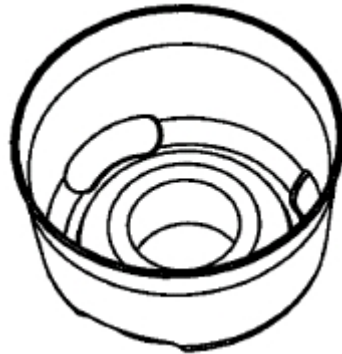

2.2

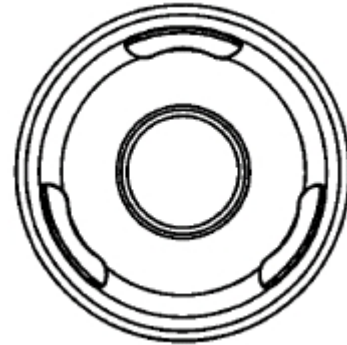

2.3

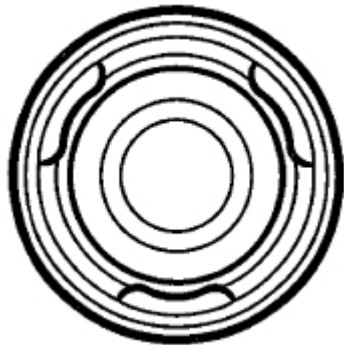

2.4

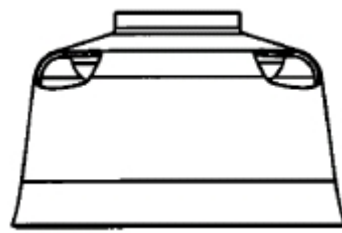

2.5

(11)	Reg.nr.:	084010
(21)	Søkn.nr.:	20121043
(22)	Inngitt:	2012.12.06
(24)	Løpedag:	2012.12.06
(43)	Allm. tilgj.:	2013.06.06
(15)	Registrert:	2013.06.20
(45)	Kunngjort:	2013.07.08
(18)	Reg. gjelder til:	2017.12.06
(74)	Fullmektig:	Bryn Aarflot AS, Postboks 449 Sentrum, 0104 OSLO, Norge
(73)	Innehaber:	WLI Trading Ltd, Second Floor, Suite 4, Beacon Court, Sandyford, IE- DUBLIN, Irland

Design 1

(54)	Produkt:	Vanndispenser
(51)	Klasse:	20-01
(72)	Designer:	Jonathan Ben-David, No 10 Jinling Road, Jinling Industrial Zone Qingdao, Chengyang District, 266111 QINGDAO, Kina (CN) Heung Soon Kim, No 10 Jinling Road, Jinling Industrial Zone Qingdao, Chengyang District, 266111 QINGDAO, Kina (CN)
(55)	Designavbildninger:	

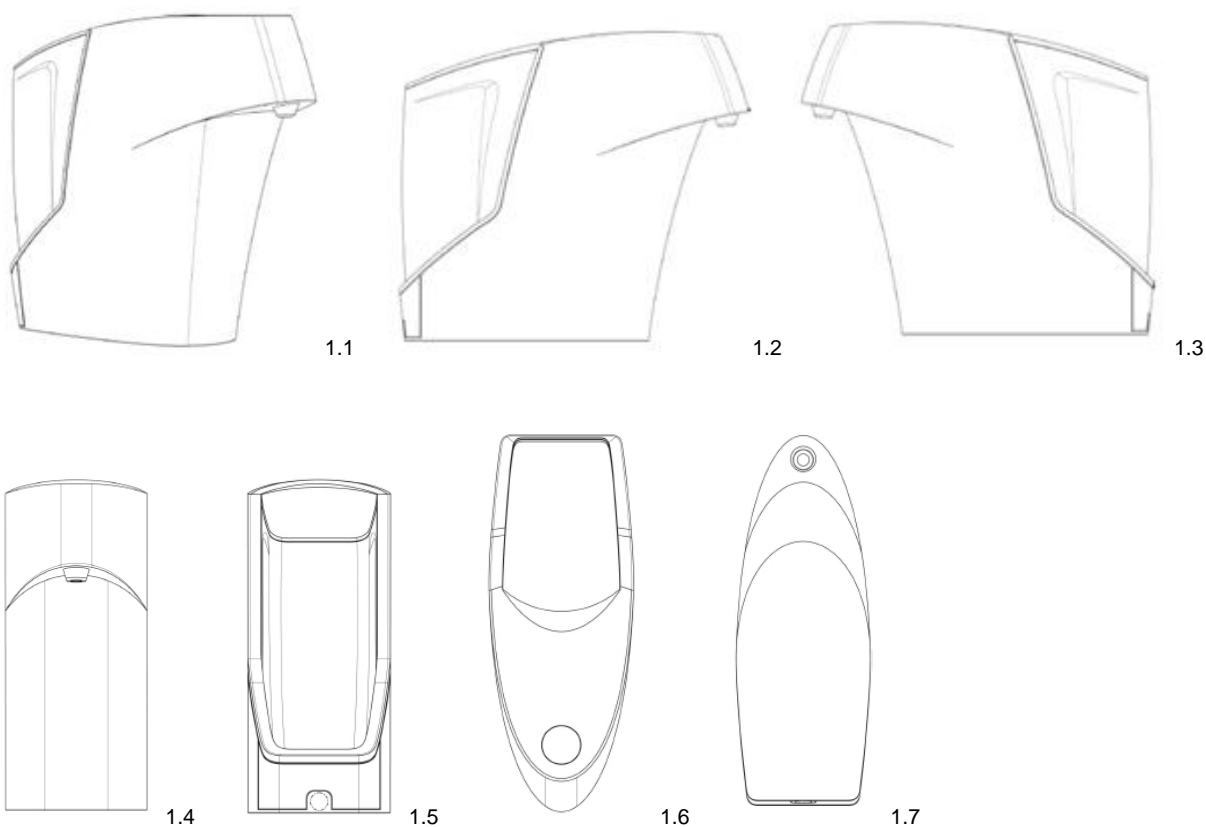

- (11) **Reg.nr.:** 084011
(21) **Søkn.nr.:** 20121067
(22) **Inngitt:** 2012.12.14
(24) **Løpedag:** 2012.12.14
(43) **Allm. tilgj.:** 2012.12.14
(15) **Registrert:** 2013.06.20
(45) **Kunngjort:** 2013.07.08
(18) **Reg. gjelder til:** 2017.12.14
(73) **Innehaver:** Vigdis Antonie Olaussen, Sorgenfrigt. 38B, 0365 OSLO, Norge

Design 1

- (54) **Produkt:** Barnestol med klatretrapp
(51) **Klasse:** 06-01
(72) **Designer:** Vigdis Antonie Olaussen, Sorgenfrigt. 38B, 0365 OSLO
(55) **Designavbildninger:**

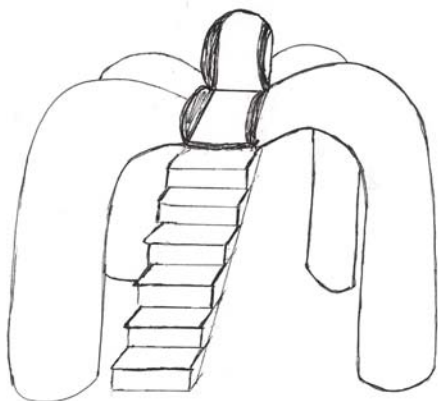

1.1

- (11) **Reg.nr.:** 084012
(21) **Søkn.nr.:** 20121068
(22) **Inngitt:** 2012.12.14
(24) **Løpedag:** 2012.12.14
(43) **Allm. tilgj.:** 2012.12.14
(15) **Registrert:** 2013.06.20
(45) **Kunngjort:** 2013.07.08
(18) **Reg. gjelder til:** 2017.12.14
(73) **Innehaver:** Vigdis Antonie Olaussen, Sorgenfrigt. 38B, 0365 OSLO, Norge

Design 1

- (54) **Produkt:** Barnestol med fire seter
(51) **Klasse:** 06-01
(72) **Designer:** Vigdis Antonie Olaussen, Sorgenfrigt. 38B, 0365 OSLO
(55) **Designavbildninger:**

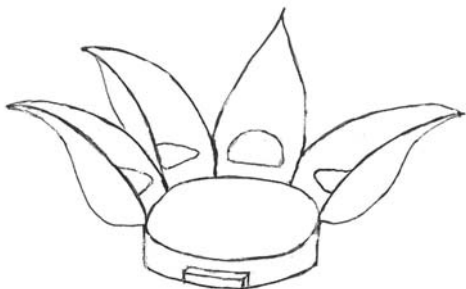

1.1

(11) **Reg.nr.:** 084013
(21) **Søkn.nr.:** 20121069
(22) **Inngitt:** 2012.12.14
(24) **Løpedag:** 2012.12.14
(43) **Allm. tilgj.:** 2012.12.14
(15) **Registrert:** 2013.06.20
(45) **Kunngjort:** 2013.07.08
(18) **Reg. gjelder til:** 2017.12.14
(73) **Innehaver:** Vigdis Antonie Olausen, Sorgenfrigt. 38B, 0365 OSLO, Norge

Design 1

(54) **Produkt:** Barnestol med dør
(51) **Klasse:** 06-01
(72) **Designer:** Vigdis Antonie Olausen, Sorgenfrigt. 38B, 0365 OSLO
(55) **Designavbildninger:**



1.1

Internasjonale designregistreringer

I henhold til designloven § 57 fjerde ledd, kunngjøres i dag følgende internasjonale registreringer som har virkning i Norge.

Det kan fremsettes krav om at designregistreringen helt eller delvis skal oppheves, jf. designloven §§ 58 fjerde ledd og 25 flg. og designforskriften §§ 26 flg.

Virkingen av en internasjonal registrering gjelder for den eller de periodene på fem år som søknaden er innlevert for, regnet fra den dagen registreringen ved det Internasjonale byrået anses å ha skjedd. Registreringen kan fornyes etter bestemmelsene i Genèveavtalen, se dl § 58 tredje ledd. Maksimal beskyttelsestid er 25 år.

(11)	Reg.nr.:	DM/079591
(21)	Søkn.nr.:	20121134
(22)	Inngitt i WIPO:	2012.11.21
(15)	Registrert i WIPO:	2012.11.21
(24)	Løpedag:	2012.11.21
(43)	Allm. tilgj.:	2013.05.24
(15)	Besluttet gjeldende NO:	2013.06.14
(45)	Kunngjort NO:	2013.07.08
(18)	Reg. gjelder til:	2017.11.21
(73)	Innehaver:	Würth Industrie Service GmbH & Co KG, Industriepark Würth/ Drillberg, DE-97980 BAD MERGENTHEIM, Tyskland

Design 1

(54)	Produkt:	Container
(51)	Klasse:	09-03
(72)	Designer:	Franziska Engert, Tannenstrasse 3, 97922 LAUDA-KÖNIGSHOFEN, Tyskland (DE)
(30)	Prioritet:	2012.09.21, EM, 002107375
(55)	Designavbildninger:	



1.1



1.2



1.3



1.4



1.5



1.6

(11)	Reg.nr.:	DM/079610
(21)	Søkn.nr.:	20130030
(22)	Inngitt i WIPO:	2012.11.30
(15)	Registrert i WIPO:	2012.11.30
(24)	Løpedag:	2012.11.30
(43)	Allm. tilgj.:	2013.05.31
(15)	Besluttet gjeldende NO:	2013.06.10
(45)	Kunngjort NO:	2013.07.08
(18)	Reg. gjelder til:	2017.11.30
(73)	Innehaver:	Swatch AG (Swatch SA) (Swatch Ltd), Jakob-Stämpfli-Strasse 94, CH-2502 BIEL/BIENNE, Sveits
(50)	Anmerkninger:	Designene er i farger. Registreringen gjelder samregistrering.

Design 1

(54)	Produkt:	Wristwatches
(51)	Klasse:	10-02
(72)	Designer:	Patrizio Vita, Swatchlab, Via Archimede 6, 20129 MILANO, Italia (IT)
(50)	Anmerkning:	Designen er i farger.
(55)	Designavbildninger:	



1.1

Design 2

(54)	Produkt:	Wristwatches
(51)	Klasse:	10-02
(72)	Designer:	Patrizio Vita, Swatchlab, Via Archimede 6, 20129 MILANO, Italia (IT)
(50)	Anmerkning:	Designen er i farger.
(55)	Designavbildninger:	



2.1

Design 3

(54)	Produkt:	Wristwatches
(51)	Klasse:	10-02
(72)	Designer:	Patrizio Vita, Swatchlab, Via Archimede 6, 20129 MILANO, Italia (IT)
(50)	Anmerkning:	Designen er i farger.
(55)	Designavbildninger:	



3.1

Design 4

(54)	Produkt:	Wristwatches
(51)	Klasse:	10-02
(72)	Designer:	Rossana Boffi, Swatchlab, Via Archimede 6, 20129 MILANO, Italia (IT)
(50)	Anmerkning:	Designen er i farger.
(55)	Designavbildninger:	



4.1

Design 5

(54)	Produkt:	Wristwatches
(51)	Klasse:	10-02
(72)	Designer:	Rossana Boffi, Swatchlab, Via Archimede 6, 20129 MILANO, Italia (IT)
(50)	Anmerkning:	Designen er i farger.
(55)	Designavbildninger:	



5.1

Design 6

(54)	Produkt:	Wristwatches
(51)	Klasse:	10-02
(72)	Designer:	Francesca Errani, Swatchlab, Via Archimede 6, 20129 MILANO, Italia (IT)
(50)	Anmerkning:	Designen er i farger.
(55)	Designavbildninger:	



6.1

Design 7

(54)	Produkt:	Wristwatches
(51)	Klasse:	10-02
(72)	Designer:	Francesca Errani, Swatchlab, Via Archimede 6, 20129 MILANO, Italia (IT)
(50)	Anmerkning:	Designen er i farger.
(55)	Designavbildninger:	



7.1

(11)	Reg.nr.:	DM/079611
(21)	Søkn.nr.:	20130031
(22)	Inngitt i WIPO:	2012.11.30
(15)	Registrert i WIPO:	2012.11.30
(24)	Løpedag:	2012.11.30
(43)	Allm. tilgj.:	2013.05.31
(15)	Besluttet gjeldende NO:	2013.06.10
(45)	Kunngjort NO:	2013.07.08
(18)	Reg. gjelder til:	2017.11.30
(73)	Innehaver:	Swatch AG (Swatch SA) (Swatch Ltd), Jakob-Stämpfli-Strasse 94, CH-2502 BIEL/BIENNE, Sveits
(50)	Anmerkninger:	Designene er i farger.

Registreringen gjelder samregistrering.

Design 1

(54)	Produkt:	Wristwatches
(51)	Klasse:	10-02
(72)	Designer:	Andrea Arrigoni, Swatchlab, Via Archimede 6, 20129 MILANO, Italia (IT)
(50)	Anmerkning:	Designen er i farger.
(55)	Designavbildninger:	



1.1

Design 2

(54)	Produkt:	Wristwatches
(51)	Klasse:	10-02
(72)	Designer:	Andrea Arrigoni, Swatchlab, Via Archimede 6, 20129 MILANO, Italia (IT)
(50)	Anmerkning:	Designen er i farger.
(55)	Designavbildninger:	



2.1

(11)	Reg.nr.:	DM/079612
(21)	Søkn.nr.:	20130032
(22)	Inngitt i WIPO:	2012.11.30
(15)	Registrert i WIPO:	2012.11.30
(24)	Løpedag:	2012.11.30
(43)	Allm. tilgj.:	2013.05.30
(15)	Besluttet gjeldende NO:	2013.06.10
(45)	Kunngjort NO:	2013.07.08
(18)	Reg. gjelder til:	2017.11.30
(73)	Innehaver:	Swatch AG (Swatch SA) (Swatch Ltd), Jakob-Stämpfli-Strasse 94, CH-2502 BIEL/BIENNE, Sveits
(50)	Anmerkninger:	Designene er i farger.

Registreringen gjelder samregistrering.

Design 1

(54)	Produkt:	Wristwatches
(51)	Klasse:	10-02
(72)	Designer:	Lorenzo Vallone, Swatchlab, Via Archimede 6, 20129 MILANO, Italia (IT)
(50)	Anmerkning:	Designen er i farger.
(55)	Designavbildninger:	



1.1

Design 2

(54)	Produkt:	Wristwatches
(51)	Klasse:	10-02
(72)	Designer:	Francesca Errani, Swatchlab, Via Archimede 6, 20129 MILANO, Italia (IT)
(50)	Anmerkning:	Designen er i farger.
(55)	Designavbildninger:	



2.1

(11)	Reg.nr.:	DM/079613
(21)	Søkn.nr.:	20130033
(22)	Inngitt i WIPO:	2012.11.30
(15)	Registrert i WIPO:	2012.11.30
(24)	Løpedag:	2012.11.30
(43)	Allm. tilgj.:	2013.05.31
(15)	Besluttet gjeldende NO:	2013.06.10
(45)	Kunngjort NO:	2013.07.08
(18)	Reg. gjelder til:	2017.11.30
(73)	Innehaver:	Swatch AG (Swatch SA) (Swatch Ltd), Jakob-Stämpfli-Strasse 94, CH-2502 BIEL/BIENNE, Sveits

Design 1

(54)	Produkt:	Wristwatch
(51)	Klasse:	10-02
(72)	Designer:	Andrea Arrigoni, Swatchlab, Via Archimede 6, 20129 MILANO, Italia (IT)
(55)	Designavbildninger:	



1.1

(11)	Reg.nr.:	DM/079655
(21)	Søkn.nr.:	20130043
(22)	Inngitt i WIPO:	2012.11.28
(15)	Registrert i WIPO:	2012.11.28
(24)	Løpedag:	2012.11.28
(43)	Allm. tilgj.:	2013.05.31
(15)	Besluttet gjeldende NO:	2013.06.14
(45)	Kunngjort NO:	2013.07.08
(18)	Reg. gjelder til:	2017.11.28
(73)	Innehaver:	Swatch AG (Swatch SA) (Swatch Ltd), Jakob-Stämpfli-Strasse 94, CH-2502 BIEL/BIENNE, Sveits
(50)	Anmerkninger:	Registreringen gjelder samregistrering.

Design 1

(54)	Produkt:	Watches
(51)	Klasse:	10-02
(72)	Designer:	Damien Goyet, 45, rue Principale, 68480 WINKEL, Frankrike (FR)
(55)	Designavbildninger:	



1.1

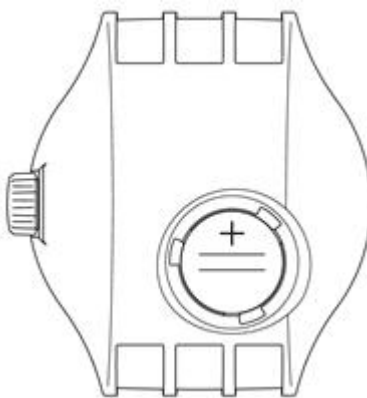

1.2

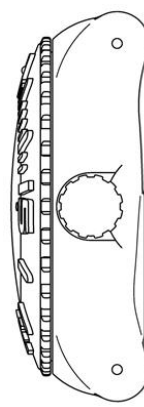

1.3

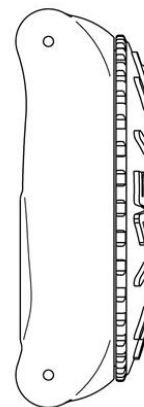

1.4

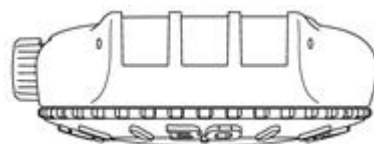

1.5

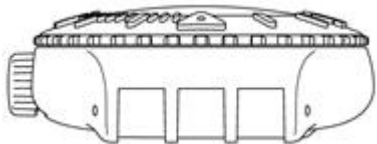

1.6

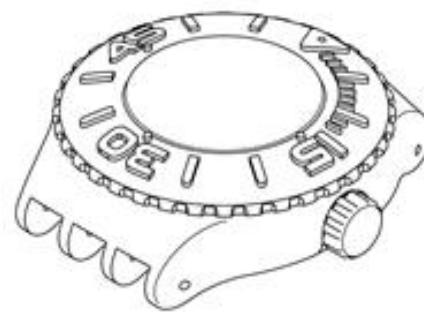

1.7

Design 2

(54) **Produkt:** Watches
 (51) **Klasse:** 10-02
 (72) **Designer:** Damien Goyet, 45, rue Principale, 68480 WINKEL, Frankrike (FR)
 (55) **Designavbildninger:**



2.1

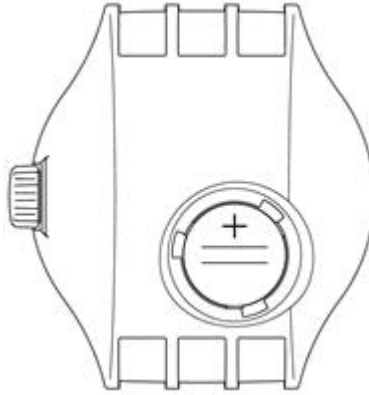

2.2

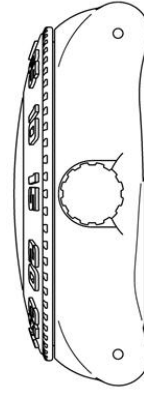

2.3

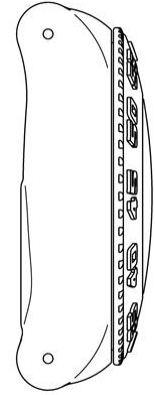

2.4

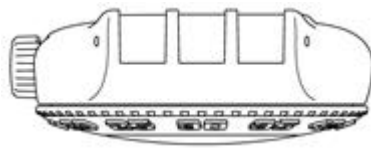

2.5

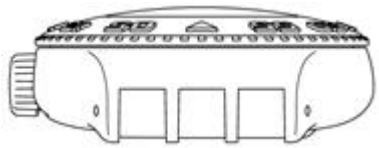

2.6

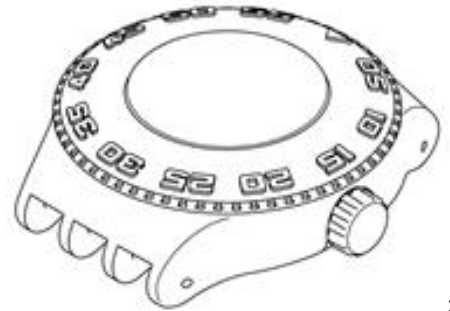

2.7

Design 3

(54) **Produkt:** Watches
 (51) **Klasse:** 10-02
 (72) **Designer:** Damien Goyet, 45, rue Principale, 68480 WINKEL, Frankrike (FR)
 (55) **Designavbildninger:**



3.1

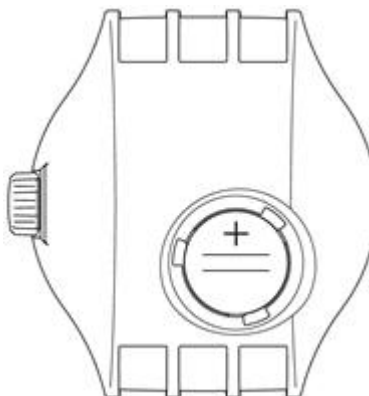

3.2

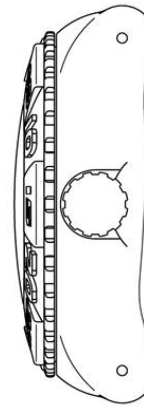

3.3

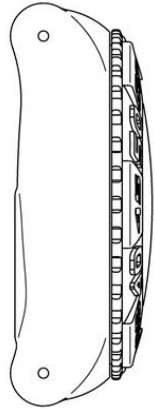

3.4

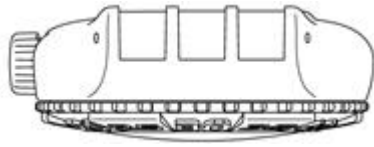

3.5

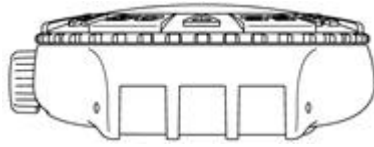

3.6

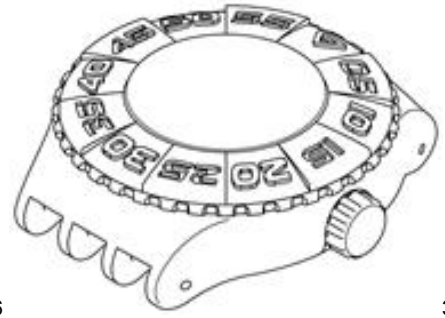

3.7

(11)	Reg.nr.:	DM/079656
(21)	Søkn.nr.:	20130044
(22)	Inngitt i WIPO:	2012.11.28
(15)	Registrert i WIPO:	2012.11.28
(24)	Løpedag:	2012.11.28
(43)	Allm. tilgj.:	2013.05.31
(15)	Besluttet gjeldende NO:	2013.06.14
(45)	Kunngjort NO:	2013.07.08
(18)	Reg. gjelder til:	2017.11.28
(73)	Innehaver:	Tissot SA (Tissot AG)(Tissot LTD), Chemin des Tourelles 17, CH-2400 LE LOCLE, Sveits
(50)	Anmerkninger:	Registreringen gjelder samregistrering.

Design 1

(54)	Produkt:	Watch cases with bracelet
(51)	Klasse:	10-02
(72)	Designer:	Damien Goyet, 45, rue Principale, 68480 WINKEL, Frankrike (FR)
(55)	Designavbildninger:	



1.1



1.2



1.3



1.4



1.5



1.6



1.7



1.8

Design 2

- (54) **Produkt:** Watch cases with bracelet
(51) **Klasse:** 10-02
(72) **Designer:** Vianin Benoît, Rue de la Banque 13, 2400 LE LOCLE, Sveits (CH)
Philippe Scherrer, Rue des Encrannes 10, 2800 DELEMONT, Sveits (CH)
(55) **Designavbildninger:**



2.1



2.2



2.3



2.4



2.5



2.6



2.7



2.8

(11)	Reg.nr.:	DM/079658
(21)	Søkn.nr.:	20130045
(22)	Inngitt i WIPO:	2012.11.29
(15)	Registrert i WIPO:	2012.11.29
(24)	Løpedag:	2012.11.29
(43)	Allm. tilgj.:	2013.05.31
(15)	Besluttet gjeldende NO:	2013.06.14
(45)	Kunngjort NO:	2013.07.08
(18)	Reg. gjelder til:	2017.11.29
(73)	Innehaver:	Certina AG (Certina SA) (Certina Ltd), Chemin des Tourelles 17, CH-2400 LE LOCLE, Sveits

Design 1

(54)	Produkt:	Watch case with bracelet
(51)	Klasse:	10-02
(72)	Designer:	Marco Scarinzi, SCARINZI S.A., Rue d'Aarberg 107A, 2501 BIENNE, Sveits (CH) Renato Scarinzi, SCARINZI S.A., Rue d'Aarberg 107A, 2501 BIENNE, Sveits (CH)
(55)	Designavbildninger:	



1.1



1.2



1.3



1.4



1.5



1.6



1.7



1.8

(11)	Reg.nr.:	DM/079662
(21)	Søkn.nr.:	20130047
(22)	Inngitt i WIPO:	2012.12.03
(15)	Registrert i WIPO:	2012.12.03
(24)	Løpedag:	2012.12.03
(43)	Allm. tilgj.:	2013.06.07
(15)	Besluttet gjeldende NO:	2013.06.18
(45)	Kunngjort NO:	2013.07.08
(18)	Reg. gjelder til:	2017.12.03
(73)	Innehaver:	Tod's SpA, Via Filippo Della Valle, 1, IT-63811 SANTELPIDIO A MARE (FM), Italia
(50)	Anmerkninger:	Registreringen gjelder samregistrering.

Design 1

(54)	Produkt:	Shoes
(51)	Klasse:	02-04
(72)	Designer:	Andrea Della Valle, Via Filippo Della Valle 1, 63811 SANTELPIDIO A MARE (FERMO), Italia (IT) Sylvie Bourdin, Via Filippo Della Valle 1, 63811 SANTELPIDIO A MARE (FERMO), Italia (IT)
(30)	Prioritet:	2012.06.05, EM, 002052753
(55)	Designavbildninger:	



Design 2

(54)	Produkt:	Shoes
(51)	Klasse:	02-04
(72)	Designer:	Andrea Della Valle, Via Filippo Della Valle 1, 63811 SANT'ELPIDIO A MARE (FERMO), Italia (IT) Sylvie Bourdin, Via Filippo Della Valle 1, 63811 SANT'ELPIDIO A MARE (FERMO), Italia (IT)
(30)	Prioritet:	2012.06.05, EM, 002052753
(55)	Designavbildninger:	



2.1



2.2



2.3



2.4



2.5



2.6



2.7

Design 3

(54)	Produkt:	Shoes
(51)	Klasse:	02-04
(72)	Designer:	Andrea Della Valle, Via Filippo Della Valle 1, 63811 SANT'ELPIDIO A MARE (FERMO), Italia (IT) Francesco Celin, Via Filippo Della Valle 1, 63811 SANT'ELPIDIO A MARE (FERMO), Italia (IT)
(30)	Prioritet:	2012.06.05, EM, 002052753
(55)	Designavbildninger:	



3.1



3.2



3.3



3.4



3.5



3.6



3.7

Design 4

(54)	Produkt:	Shoes
(51)	Klasse:	02-04
(72)	Designer:	Andrea Della Valle, Via Filippo Della Valle 1, 63811 SANT'ELPIDIO A MARE (FERMO), Italia (IT) Francesco Celin, Via Filippo Della Valle 1, 63811 SANT'ELPIDIO A MARE (FERMO), Italia (IT)
(30)	Prioritet:	2012.06.05, EM, 002052753
(55)	Designavbildninger:	



4.1



4.2



4.3



4.4



4.5



4.6



4.7

Design 5

(54)	Produkt:	Shoes
(51)	Klasse:	02-04
(72)	Designer:	Andrea Della Valle, Via Filippo Della Valle 1, 63811 SANT'ELPIDIO A MARE (FERMO), Italia (IT) Francesco Celin, Via Filippo Della Valle 1, 63811 SANT'ELPIDIO A MARE (FERMO), Italia (IT)
(30)	Prioritet:	2012.06.05, EM, 002052753
(55)	Designavbildninger:	



5.1



5.2



5.3



5.4



5.5



5.6



5.7

Design 6

(54)	Produkt:	Footwear soles
(51)	Klasse:	02-04
(72)	Designer:	Andrea Della Valle, Via Filippo Della Valle 1, 63811 SANT'ELPIDIO A MARE (FERMO), Italia (IT) Monica Mei, Via Filippo Della Valle 1, 63811 SANT'ELPIDIO A MARE (FERMO), Italia (IT)
(30)	Prioritet:	2012.06.05, EM, 002052753
(55)	Designavbildninger:	



Design 7

(54)	Produkt:	Footwear soles
(51)	Klasse:	02-04
(72)	Designer:	Andrea Della Valle, Via Filippo Della Valle 1, 63811 SANT'ELPIDIO A MARE (FERMO), Italia (IT) Francesco Celin, Via Filippo Della Valle 1, 63811 SANT'ELPIDIO A MARE (FERMO), Italia (IT)
(30)	Prioritet:	2012.06.05, EM, 002052753
(55)	Designavbildninger:	

**Design 8**

(54)	Produkt:	Footwear soles
(51)	Klasse:	02-04
(72)	Designer:	Andrea Della Valle, Via Filippo Della Valle 1, 63811 SANT'ELPIDIO A MARE (FERMO), Italia (IT) Francesco Celin, Via Filippo Della Valle 1, 63811 SANT'ELPIDIO A MARE (FERMO), Italia (IT)
(30)	Prioritet:	2012.06.05, EM, 002052753
(55)	Designavbildninger:	

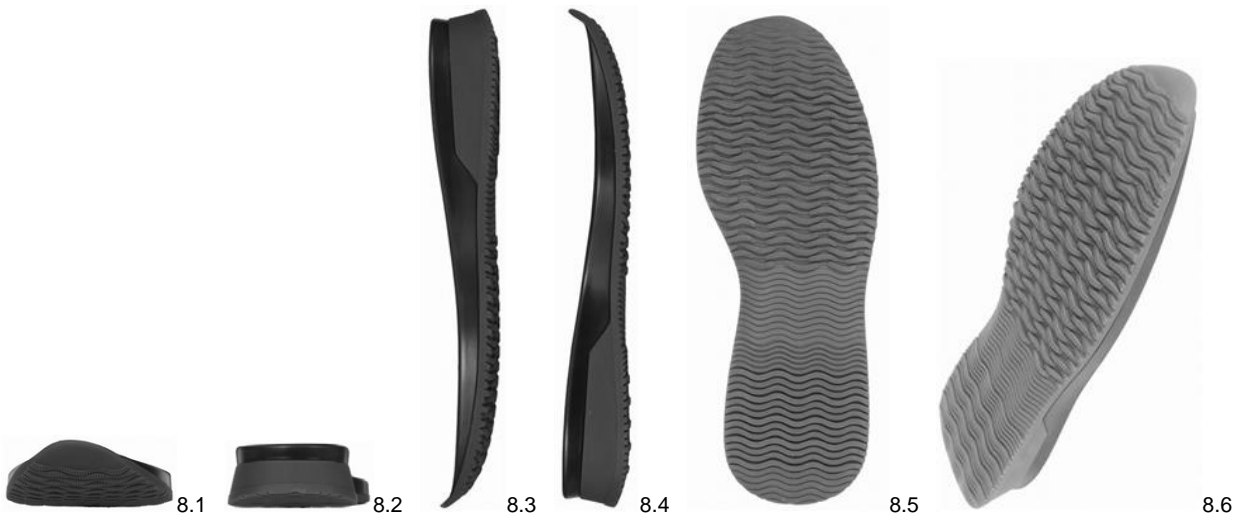

Design 9

- (54) **Produkt:** Footwear soles
 (51) **Klasse:** 02-04
 (72) **Designer:** Andrea Della Valle, Via Filippo Della Valle 1, 63811 SANT'ELPIDIO A MARE (FERMO), Italia (IT)
 Sylvie Bourdin, Via Filippo Della Valle 1, 63811 SANT'ELPIDIO A MARE (FERMO), Italia (IT)
 (30) **Prioritet:** 2012.06.05, EM, 002052753
 (55) **Designavbildninger:**

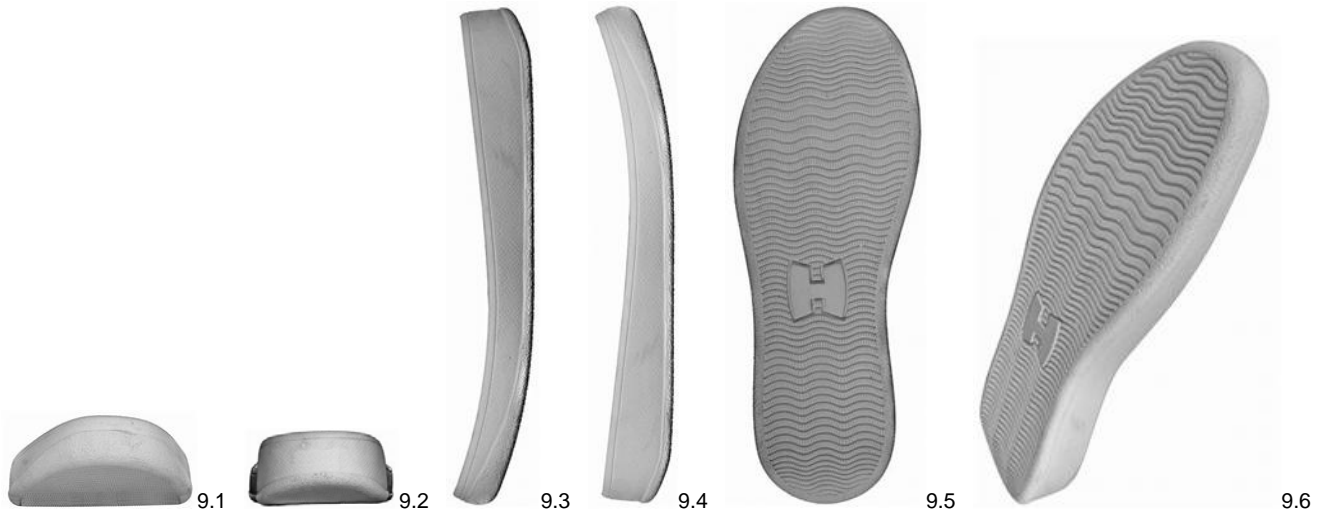
**Design 10**

- (54) **Produkt:** Footwear soles
 (51) **Klasse:** 02-04
 (72) **Designer:** Andrea Della Valle, Via Filippo Della Valle 1, 63811 SANT'ELPIDIO A MARE (FERMO), Italia (IT)
 Max Kibardin, Via Marconi 2, 6900 LUGANO, Sveits (CH)
 (30) **Prioritet:** 2012.06.05, EM, 002052753
 (55) **Designavbildninger:**

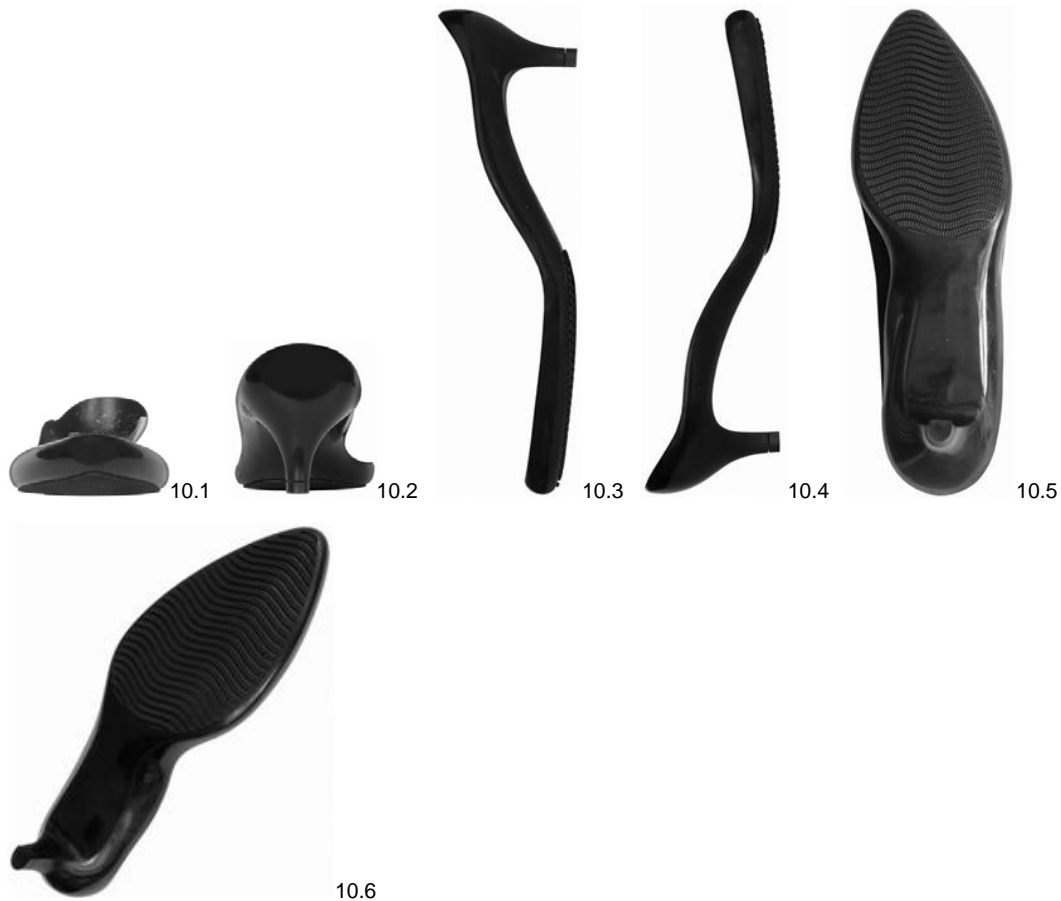

Design 11

(54)	Produkt:	Footwear soles
(51)	Klasse:	02-04
(72)	Designer:	Andrea Della Valle, Via Filippo Della Valle 1, 63811 SANT'ELPIDIO A MARE (FERMO), Italia (IT) Monica Mei, Via Filippo Della Valle 1, 63811 SANT'ELPIDIO A MARE (FERMO), Italia (IT)
(30)	Prioritet:	2012.06.05, EM, 002052753
(55)	Designavbildninger:	



11.1



11.2



11.3



11.4



11.5



11.6

(11)	Reg.nr.:	DM/079663
(21)	Søkn.nr.:	20130048
(22)	Inngitt i WIPO:	2012.12.03
(15)	Registrert i WIPO:	2012.12.03
(24)	Løpedag:	2012.12.03
(43)	Allm. tilgj.:	2013.06.07
(15)	Besluttet gjeldende NO:	2013.06.18
(45)	Kunngjort NO:	2013.07.08
(18)	Reg. gjelder til:	2017.12.03
(73)	Innehaver:	ETA SA Manufacture Horlogère Suisse, CH-2540 GRENCHEN, Sveits
(50)	Anmerkninger:	Designene er i farger. Registreringen gjelder samregistrering.

Design 1

(54)	Produkt:	Wristwatches
(51)	Klasse:	10-02
(72)	Designer:	Michaela Koch, Albrecht Achilles-Strasse 2, 10709 BERLIN, Tyskland (DE)
(50)	Anmerkning:	Designen er i farger.
(55)	Designavbildninger:	



1.1

Design 2

(54)	Produkt:	Wristwatches
(51)	Klasse:	10-02
(72)	Designer:	Michaela Koch, Albrecht Achilles-Strasse 2, 10709 BERLIN, Tyskland (DE)
(50)	Anmerkning:	Designen er i farger.
(55)	Designavbildninger:	



2.1

Design 3

- (54) **Produkt:** Wristwatches
(51) **Klasse:** 10-02
(72) **Designer:** Michaela Koch, Albrecht Achilles-Strasse 2, 10709 BERLIN, Tyskland (DE)
(50) **Anmerkning:** Designen er i farger.
(55) **Designavbildninger:**



3.1

Design 4

- (54) **Produkt:** Wristwatches
(51) **Klasse:** 10-02
(72) **Designer:** Michaela Koch, Albrecht Achilles-Strasse 2, 10709 BERLIN, Tyskland (DE)
(50) **Anmerkning:** Designen er i farger.
(55) **Designavbildninger:**



4.1

Design 5

(54)	Produkt:	Wristwatches
(51)	Klasse:	10-02
(72)	Designer:	Véronique Stoll, Chemin de la Marnière 14A, 2504 BIEL/BIENNE, Sveits (CH)
(50)	Anmerkning:	Designen er i farger.
(55)	Designavbildninger:	



5.1

Design 6

(54)	Produkt:	Wristwatches
(51)	Klasse:	10-02
(72)	Designer:	Véronique Stoll, Chemin de la Marnière 14A, 2504 BIEL/BIENNE, Sveits (CH)
(50)	Anmerkning:	Designen er i farger.
(55)	Designavbildninger:	



6.1

Design 7

(54)	Produkt:	Wristwatches
(51)	Klasse:	10-02
(72)	Designer:	Michaela Koch, Albrecht Achilles-Strasse 2, 10709 BERLIN, Tyskland (DE)
(50)	Anmerkning:	Designen er i farger.
(55)	Designavbildninger:	



7.1

Design 8

(54)	Produkt:	Wristwatches
(51)	Klasse:	10-02
(72)	Designer:	Michaela Koch, Albrecht Achilles-Strasse 2, 10709 BERLIN, Tyskland (DE)
(50)	Anmerkning:	Designen er i farger.
(55)	Designavbildninger:	



8.1

Design 9

- (54) **Produkt:** Wristwatches
(51) **Klasse:** 10-02
(72) **Designer:** Véronique Stoll, Chemin de la Marnière 14A, 2504 BIEL/BIENNE, Sveits (CH)
Charlotte Fabre, Birkenweg 3, 2504 BIEL/BIENNE, Sveits (CH)
Adele di Maiuta, Viaduktstrasse 2, 2450 GRENCHEN, Sveits (CH)
- (50) **Anmerkning:** Designen er i farger.
(55) **Designavbildninger:**



9.1

Design 10

- (54) **Produkt:** Wristwatches
(51) **Klasse:** 10-02
(72) **Designer:** Véronique Stoll, Chemin de la Marnière 14A, 2504 BIEL/BIENNE, Sveits (CH)
Charlotte Fabre, Birkenweg 3, 2504 BIEL/BIENNE, Sveits (CH)
Adele di Maiuta, Viaduktstrasse 2, 2450 GRENCHEN, Sveits (CH)
- (50) **Anmerkning:** Designen er i farger.
(55) **Designavbildninger:**



10.1

Design 11

- (54) **Produkt:** Wristwatches
(51) **Klasse:** 10-02
(72) **Designer:** Véronique Stoll, Chemin de la Marnière 14A, 2504 BIEL/BIENNE, Sveits (CH)
Charlotte Fabre, Birkenweg 3, 2504 BIEL/BIENNE, Sveits (CH)
Adele di Maiuta, Viaduktstrasse 2, 2450 GRENCHEM, Sveits (CH)
(50) **Anmerkning:** Designen er i farger.
(55) **Designavbildninger:**



11.1

Design 12

- (54) **Produkt:** Wristwatches
(51) **Klasse:** 10-02
(72) **Designer:** Jérémie Senggen, Chemin du Levant 135, 1005 LAUSANNE, Sveits (CH)
(50) **Anmerkning:** Designen er i farger.
(55) **Designavbildninger:**



12.1

Design 13

(54)	Produkt:	Wristwatches
(51)	Klasse:	10-02
(72)	Designer:	Jérémie Senggen, Chemin du Levant 135, 1005 LAUSANNE, Sveits (CH)
(50)	Anmerkning:	Designen er i farger.
(55)	Designavbildninger:	



13.1

Design 14

(54)	Produkt:	Wristwatches
(51)	Klasse:	10-02
(72)	Designer:	Jérémie Senggen, Chemin du Levant 135, 1005 LAUSANNE, Sveits (CH)
(50)	Anmerkning:	Designen er i farger.
(55)	Designavbildninger:	



14.1

(11)	Reg.nr.:	DM/079669
(21)	Søkn.nr.:	20130050
(22)	Inngitt i WIPO:	2012.11.29
(15)	Registrert i WIPO:	2012.11.29
(24)	Løpedag:	2012.11.29
(43)	Allm. tilgj.:	2013.05.31
(15)	Besluttet gjeldende NO:	2013.06.18
(45)	Kunngjort NO:	2013.07.08
(18)	Reg. gjelder til:	2017.11.29
(73)	Innehaver:	Gotec SA, Rue des Casernes 59, CH-1950 SION, Sveits

Design 1

(54)	Produkt:	Coffee machine
(51)	Klasse:	07-02
(72)	Designer:	Vincent Grenon, La Vouagère 18, 1908 RIDDES, Sveits (CH) Julien Balet, Route des Dailleys 4, 1981 VEX, Sveits (CH) Vincent Nanchen, Route des Combes 5, 3979 GRÔNE, Sveits (CH)
(55)	Designavbildninger:	



1.1

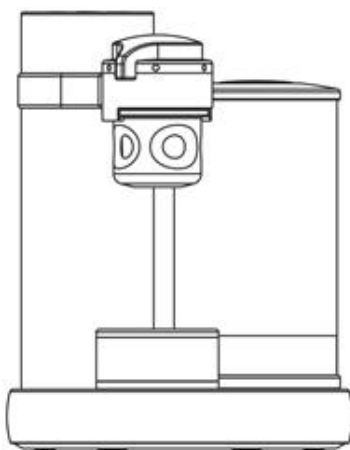

1.2

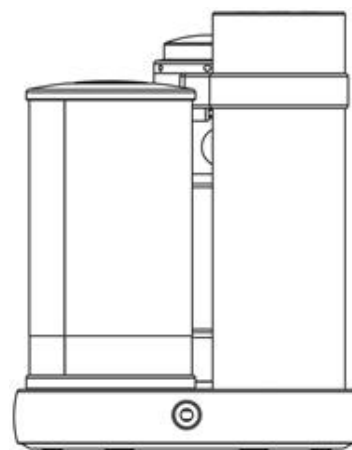

1.3

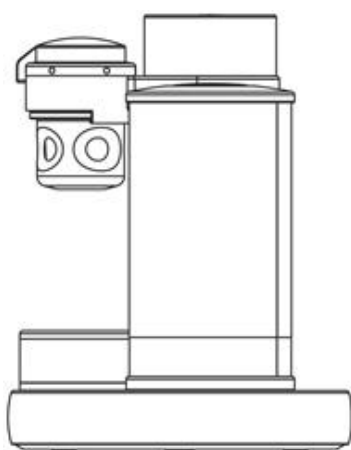

1.4

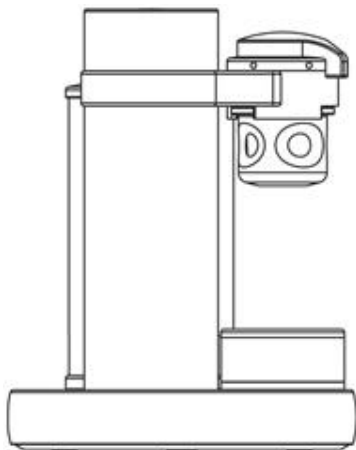

1.5

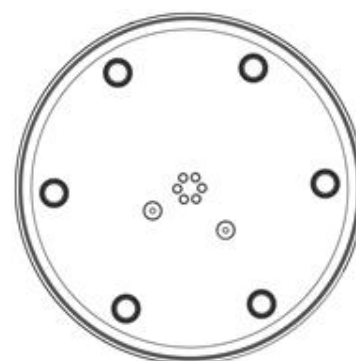

1.6



1.7

(11)	Reg.nr.:	DM/079695
(21)	Søkn.nr.:	20130082
(22)	Inngitt i WIPO:	2012.12.03
(15)	Registrert i WIPO:	2012.12.03
(24)	Løpedag:	2012.12.03
(43)	Allm. tilgj.:	2013.06.07
(15)	Besluttet gjeldende NO:	2013.06.18
(45)	Kunngjort NO:	2013.07.08
(18)	Reg. gjelder til:	2017.12.03
(73)	Innehaver:	Saint-Gobain Glass France, 18, avenue d'Alsace, FR-92400 COURBEVOIE, Frankrike
(50)	Anmerkninger:	Registreringen gjelder samregistrering.

Design 1

(54)	Produkt:	Radiators
(51)	Klasse:	23-03
(72)	Designer:	Walter Schreiber, Lortzing Str. 5, 52074 AACHEN, Tyskland (DE) Dang Cuong Phan, Alexanderstrasse 96, 52062 AACHEN, Tyskland (DE) Sabine Velden, Goltsteinstrasse 71, 52459 INDEN, Tyskland (DE)
(30)	Prioritet:	2012.06.01, DE, 402012002548
(55)	Designavbildninger:	

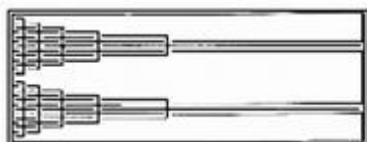

1.1

Design 2

(54)	Produkt:	Radiators
(51)	Klasse:	23-03
(72)	Designer:	Walter Schreiber, Lortzing Str. 5, 52074 AACHEN, Tyskland (DE) Dang Cuong Phan, Alexanderstrasse 96, 52062 AACHEN, Tyskland (DE) Sabine Velden, Goltsteinstrasse 71, 52459 INDEN, Tyskland (DE)
(30)	Prioritet:	2012.06.01, DE, 402012002548
(55)	Designavbildninger:	

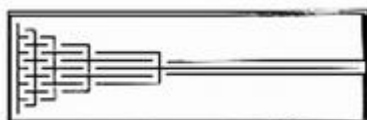

2.1

(11)	Reg.nr.:	DM/079698
(21)	Søkn.nr.:	20130084
(22)	Inngitt i WIPO:	2012.12.06
(15)	Registrert i WIPO:	2012.12.06
(24)	Løpedag:	2012.12.06
(43)	Allm. tilgj.:	2013.06.07
(15)	Besluttet gjeldende NO:	2013.06.20
(45)	Kunngjort NO:	2013.07.08
(18)	Reg. gjelder til:	2017.12.06
(73)	Innehaver:	Koninklijke Philips Electronics NV, Groenewoudseweg 1, NL-5621BA EINDHOVEN, Nederland
(50)	Anmerkninger:	Registreringen gjelder samregistrering.

Design 1

(54)	Produkt:	Juicer
(51)	Klasse:	31-00
(72)	Designer:	Ted Chun Pong Yuan, 713 Block 10, Kwai Shing Est. KWAI CHUNG NT, HONG KONG, Kina (CN)
(30)	Prioritet:	2012.06.14, EM, 002057919
(55)	Designavbildninger:	



1.1

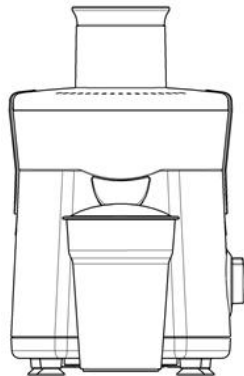

1.2

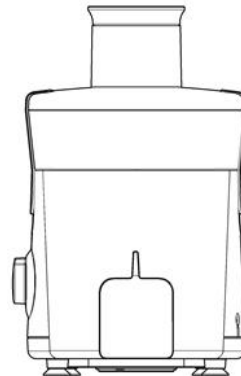

1.3



1.4



1.5

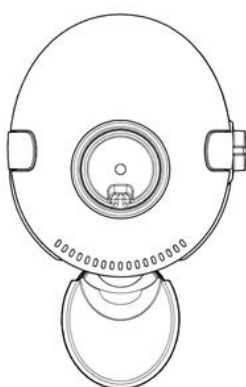

1.6

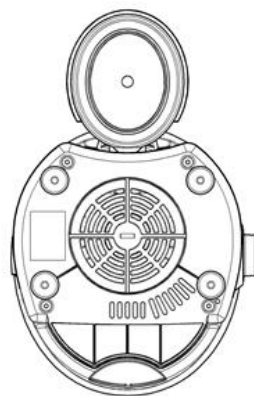

1.7

Design 2

- (54) **Produkt:** Blender
(51) **Klasse:** 31-00
(72) **Designer:** Ted Chun Pong Yuan, 713 Block 10, Kwai Shing Est. KWAI CHUNG NT, HONG KONG, Kina (CN)
(30) **Prioritet:** 2012.06.14, EM, 002057919
(55) **Designavbildninger:**

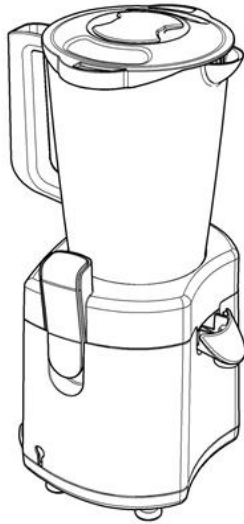

2.1

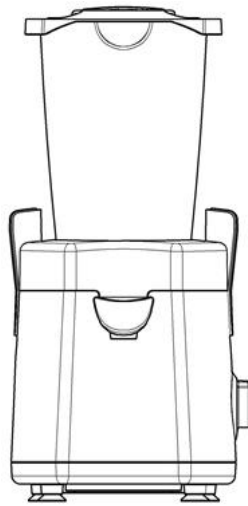

2.2

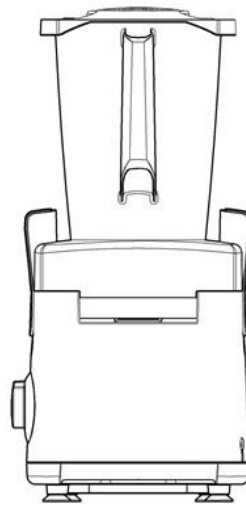

2.3

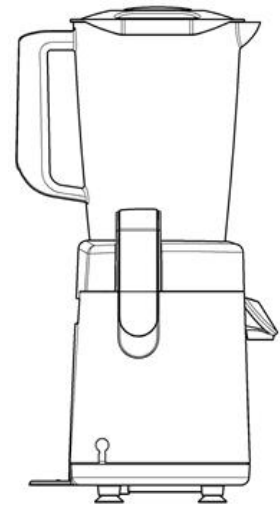

2.4

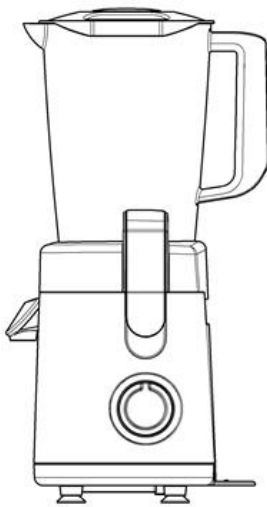

2.5

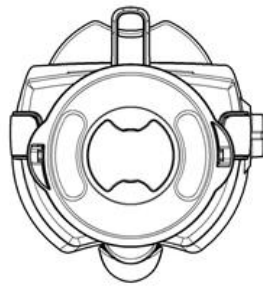

2.6

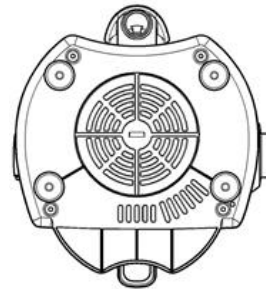

2.7

(11)	Reg.nr.:	DM/079705
(21)	Søkn.nr.:	20130087
(22)	Inngitt i WIPO:	2012.12.05
(15)	Registrert i WIPO:	2012.12.05
(24)	Løpedag:	2012.12.05
(43)	Allm. tilgj.:	2013.06.07
(15)	Besluttet gjeldende NO:	2013.06.21
(45)	Kunngjort NO:	2013.07.08
(18)	Reg. gjelder til:	2017.12.05
(73)	Innehaver:	Daimler AG, Mercedesstrasse 137, DE-70327 STUTTGART, Tyskland

Design 1

(54)	Produkt:	Wheel for vehicles
(51)	Klasse:	12-16
(72)	Designer:	Il-Hun Yoon, c/o Daimler AG, Mercedesstrasse 137, 70327 STUTTGART, Tyskland (DE)
(30)	Prioritet:	2012.06.06, EM, 002053140
(55)	Designavbildninger:	



1.1

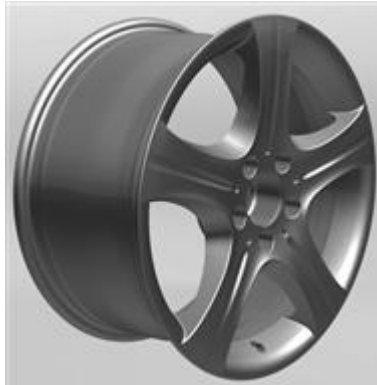

1.2

(11)	Reg.nr.:	DM/079709
(21)	Søkn.nr.:	20130088
(22)	Inngitt i WIPO:	2012.12.06
(15)	Registrert i WIPO:	2012.12.06
(24)	Løpedag:	2012.12.06
(43)	Allm. tilgj.:	2013.06.07
(15)	Besluttet gjeldende NO:	2013.06.21
(45)	Kunngjort NO:	2013.07.08
(18)	Reg. gjelder til:	2017.12.06
(73)	Innehaver:	Gravity Board Games ApS, Stårupvej 15, Østre Højby, DK-4573 HØJBY, Danmark
(50)	Anmerkninger:	Design nr. 2-7 er i farger. Registreringen gjelder samregistrering.

Design 1

(54)	Produkt:	Base for game board
(51)	Klasse:	21-01
(72)	Designer:	Lene Rose, Enghavevej 1, 4593 ESKEBJERG, Danmark (DK) Mick Rose, Enghavevej 1, 4593 ESKEBJERG, Danmark (DK)
(30)	Prioritet:	2012.06.07, EM, 002053991
(55)	Designavbildninger:	



1.1



1.2



1.3



1.4



1.5



1.6

Design 2

- (54) **Produkt:** Board games
 (51) **Klasse:** 21-01
 (72) **Designer:** Lene Rose, Enghavevej 1, 4593 ESKEBJERG, Danmark (DK)
 Mick Rose, Enghavevej 1, 4593 ESKEBJERG, Danmark (DK)
 (30) **Prioritet:** 2012.06.07, EM, 002053991
 (50) **Anmerkning:** Designen er i farger.
 (55) **Designavbildninger:**

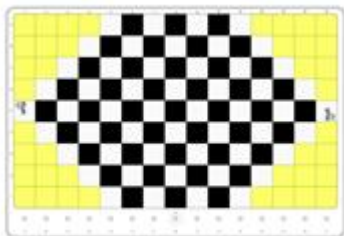

2.1

Design 3

- (54) **Produkt:** Board games
 (51) **Klasse:** 21-01
 (72) **Designer:** Lene Rose, Enghavevej 1, 4593 ESKEBJERG, Danmark (DK)
 Mick Rose, Enghavevej 1, 4593 ESKEBJERG, Danmark (DK)
 (30) **Prioritet:** 2012.06.07, EM, 002053991
 (50) **Anmerkning:** Designen er i farger.
 (55) **Designavbildninger:**

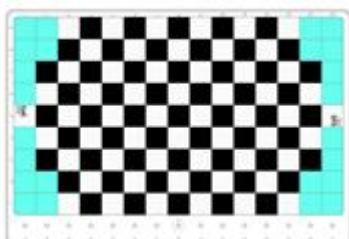

3.1

Design 4

- (54) **Produkt:** Board games
 (51) **Klasse:** 21-01
 (72) **Designer:** Lene Rose, Enghavevej 1, 4593 ESKEBJERG, Danmark (DK)
 Mick Rose, Enghavevej 1, 4593 ESKEBJERG, Danmark (DK)
 (30) **Prioritet:** 2012.06.07, EM, 002053991
 (50) **Anmerkning:** Designen er i farger.
 (55) **Designavbildninger:**

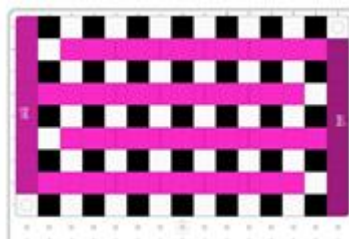

4.1

Design 5

- (54) **Produkt:** Board games
(51) **Klasse:** 21-01
(72) **Designer:** Lene Rose, Enghavevej 1, 4593 ESKEBJERG, Danmark (DK)
Mick Rose, Enghavevej 1, 4593 ESKEBJERG, Danmark (DK)
(30) **Prioritet:** 2012.06.07, EM, 002053991
(50) **Anmerkning:** Designen er i farger.
(55) **Designavbildninger:**

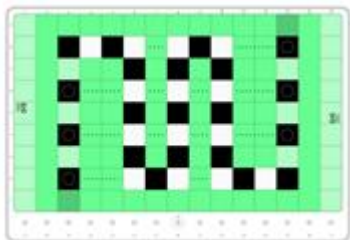

5.1

Design 6

- (54) **Produkt:** Board games
(51) **Klasse:** 21-01
(72) **Designer:** Lene Rose, Enghavevej 1, 4593 ESKEBJERG, Danmark (DK)
Mick Rose, Enghavevej 1, 4593 ESKEBJERG, Danmark (DK)
(30) **Prioritet:** 2012.06.07, EM, 002053991
(50) **Anmerkning:** Designen er i farger.
(55) **Designavbildninger:**

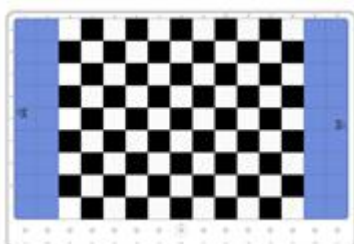

6.1

Design 7

- (54) **Produkt:** Board games
(51) **Klasse:** 21-01
(72) **Designer:** Lene Rose, Enghavevej 1, 4593 ESKEBJERG, Danmark (DK)
Mick Rose, Enghavevej 1, 4593 ESKEBJERG, Danmark (DK)
(30) **Prioritet:** 2012.06.07, EM, 002053991
(50) **Anmerkning:** Designen er i farger.
(55) **Designavbildninger:**

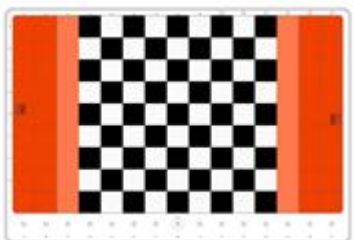

7.1

(11)	Reg.nr.:	DM/079717
(21)	Søkn.nr.:	20130092
(22)	Inngitt i WIPO:	2012.12.03
(15)	Registrert i WIPO:	2012.12.03
(24)	Løpedag:	2012.12.03
(43)	Allm. tilgj.:	2013.06.07
(15)	Besluttet gjeldende NO:	2013.06.21
(45)	Kunngjort NO:	2013.07.08
(18)	Reg. gjelder til:	2017.12.03
(73)	Innehaver:	Müller & Meirer Lederwarenfabrik GmbH, Am Markt 8, DE-55606 KIRN, Tyskland
(50)	Anmerkninger:	Registreringen gjelder samregistrering.

Design 1

(54)	Produkt:	Clasps for leather goods
(51)	Klasse:	08-07
(72)	Designer:	Steffen Neumann, Albert-Schweitzer-Strasse 10, 55606 KIRN, Tyskland (DE)
(55)	Designavbildninger:	



1.1



1.2



1.3

Design 2

(54)	Produkt:	Clasps for leather goods
(51)	Klasse:	08-07
(72)	Designer:	Steffen Neumann, Albert-Schweitzer-Strasse 10, 55606 KIRN, Tyskland (DE)
(55)	Designavbildninger:	



2.1



2.2



2.3

Design 3

(54)	Produkt:	Clasps for leather goods
(51)	Klasse:	08-07
(72)	Designer:	Steffen Neumann, Albert-Schweitzer-Strasse 10, 55606 KIRN, Tyskland (DE)
(55)	Designavbildninger:	



3.1



3.2



3.3

Design 4

- (54) **Produkt:** Clasps for leather goods
 (51) **Klasse:** 08-07
 (72) **Designer:** Steffen Neumann, Albert-Schweitzer-Strasse 10, 55606 KIRN, Tyskland (DE)
 (55) **Designavbildninger:**



4.1



4.2



4.3



4.4



4.5

Design 5

- (54) **Produkt:** Clasps for leather goods
 (51) **Klasse:** 08-07
 (72) **Designer:** Steffen Neumann, Albert-Schweitzer-Strasse 10, 55606 KIRN, Tyskland (DE)
 (55) **Designavbildninger:**



5.1



5.2



5.3

Design 6

- (54) **Produkt:** Clasps for leather goods
 (51) **Klasse:** 08-07
 (72) **Designer:** Steffen Neumann, Albert-Schweitzer-Strasse 10, 55606 KIRN, Tyskland (DE)
 (55) **Designavbildninger:**



6.1



6.2



6.3



6.4

Design 7

- (54) **Produkt:** Clasps for leather goods
 (51) **Klasse:** 08-07
 (72) **Designer:** Steffen Neumann, Albert-Schweitzer-Strasse 10, 55606 KIRN, Tyskland (DE)
 (55) **Designavbildninger:**



7.1



7.2



7.3

Design 8

- (54) **Produkt:** Clasps for leather goods
 (51) **Klasse:** 08-07
 (72) **Designer:** Steffen Neumann, Albert-Schweitzer-Strasse 10, 55606 KIRN, Tyskland (DE)
 (55) **Designavbildninger:**



8.1



8.2



8.3

Design 9

- (54) **Produkt:** Clasps for leather goods
 (51) **Klasse:** 08-07
 (72) **Designer:** Steffen Neumann, Albert-Schweitzer-Strasse 10, 55606 KIRN, Tyskland (DE)
 (55) **Designavbildninger:**



9.1



9.2



9.3



9.4



9.5



9.6



9.7

Design 10

- (54) **Produkt:** Clasps for leather goods
 (51) **Klasse:** 08-07
 (72) **Designer:** Steffen Neumann, Albert-Schweitzer-Strasse 10, 55606 KIRN, Tyskland (DE)
 (55) **Designavbildninger:**



10.1



10.2



10.3

Design 11

- (54) **Produkt:** Clasps for leather goods
 (51) **Klasse:** 08-07
 (72) **Designer:** Steffen Neumann, Albert-Schweitzer-Strasse 10, 55606 KIRN, Tyskland (DE)
 (55) **Designavbildninger:**



11.1



11.2



11.3

Design 12

(54) **Produkt:** Clasps for leather goods
(51) **Klasse:** 08-07
(72) **Designer:** Steffen Neumann, Albert-Schweitzer-Strasse 10, 55606 KIRN, Tyskland (DE)
(55) **Designavbildninger:**



12.1



12.2



12.3



12.4



12.5



12.6

(11)	Reg.nr.:	DM/079767
(21)	Søkn.nr.:	20130075
(22)	Inngitt i WIPO:	2012.12.11
(15)	Registrert i WIPO:	2012.12.11
(24)	Løpedag:	2012.12.11
(43)	Allm. tilgj.:	2013.06.14
(15)	Besluttet gjeldende NO:	2013.06.20
(45)	Kunngjort NO:	2013.07.08
(18)	Reg. gjelder til:	2017.12.11
(73)	Innehaver:	Phoenix Contact GmbH & Co KG, Flachsmarktstraße 8, DE-32825 BLOMBERG, Tyskland
(50)	Anmerkninger:	Registreringen gjelder samregistrering.

Design 1

(54)	Produkt:	Electrical connectors
(51)	Klasse:	13-03
(72)	Designer:	Dennis Habirov, Schloßhofstraße 30a, 33615 BIELEFELD, Tyskland (DE) Christian Kloppenburg, Salzkottener Straße 48, 33142 BÜREN WEWELSBURG, Tyskland (DE) Olaf Schyrocki, Fröbelstraße 10, 31812 BAD PYRMONT, Tyskland (DE)
(30)	Prioritet:	2012.06.13, EM, 002057125
(55)	Designavbildninger:	

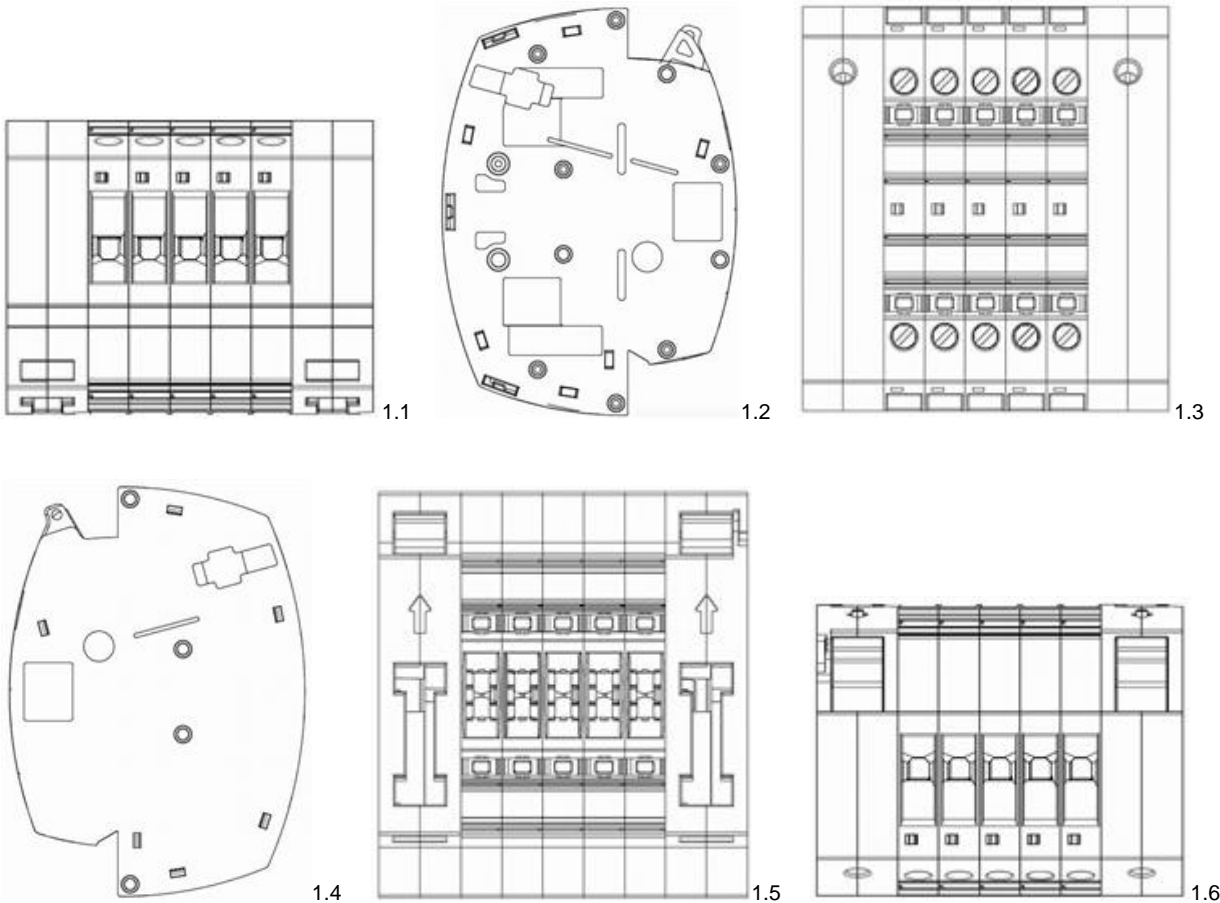

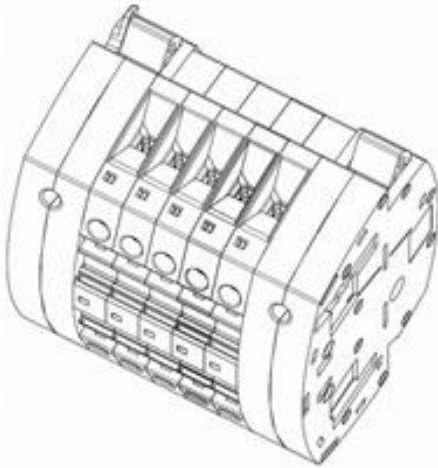

1.7

Design 2

- (54) **Produkt:** Electrical connectors
- (51) **Klasse:** 13-03
- (72) **Designer:** Dennis Habirov, Schloßhofstraße 30a, 33615 BIELEFELD, Tyskland (DE)
Christian Kloppenburg, Salzkottener Straße 48, 33142 BÜREN WEWELSBURG, Tyskland (DE)
Olaf Schyrocki, Fröbelstraße 10, 31812 BAD PYRMONT, Tyskland (DE)
- (30) **Prioritet:** 2012.06.13, EM, 002057125
- (55) **Designavbildninger:**

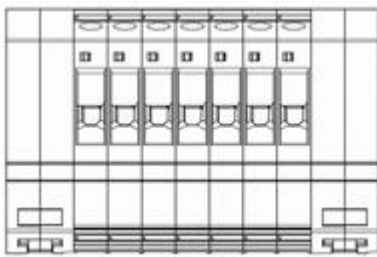

2.1

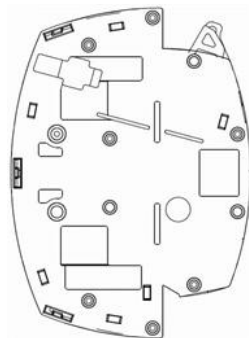

2.2

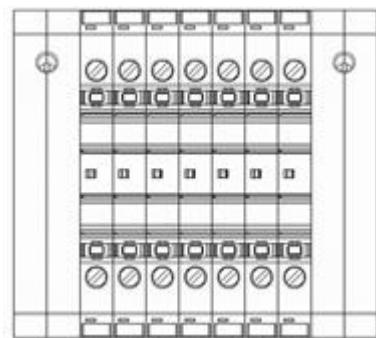

2.3

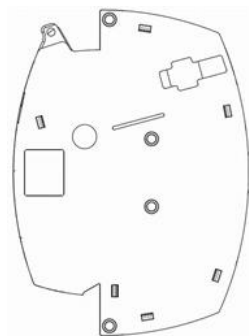

2.4

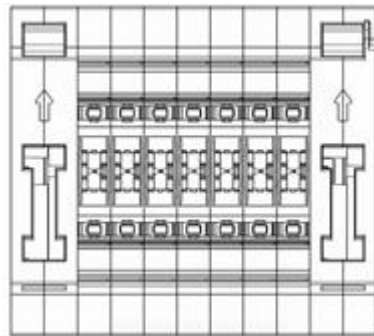

2.5

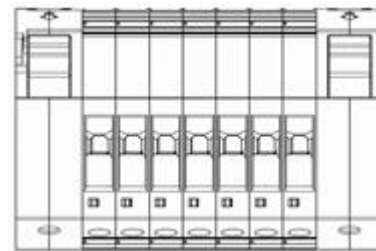

2.6

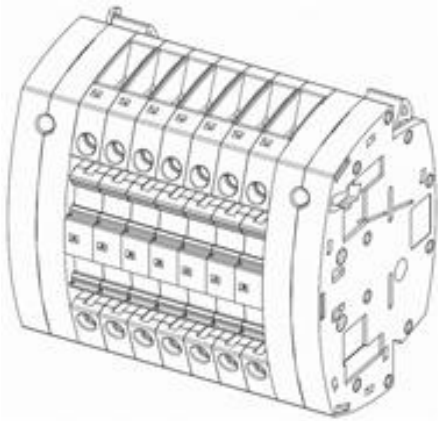

2.7

Design 3

- (54) **Produkt:** Electrical connectors
- (51) **Klasse:** 13-03
- (72) **Designer:** Dennis Habirov, Schloßhofstraße 30a, 33615 BIELEFELD, Tyskland (DE)
Christian Kloppenburg, Salzkottener Straße 48, 33142 BÜREN WEWELSBURG, Tyskland (DE)
Olaf Schyrocki, Fröbelstraße 10, 31812 BAD PYRMONT, Tyskland (DE)
- (30) **Prioritet:** 2012.06.13, EM, 002057125
- (55) **Designavbildninger:**

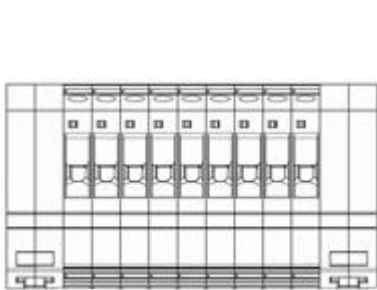

3.1

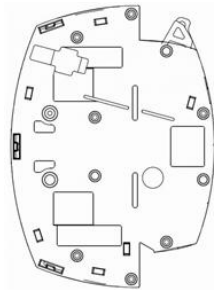

3.2

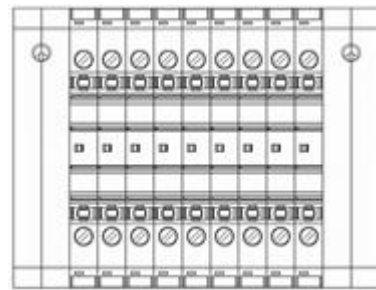

3.3

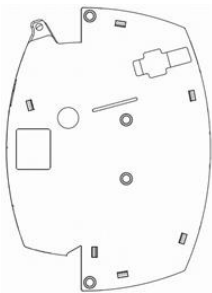

3.4

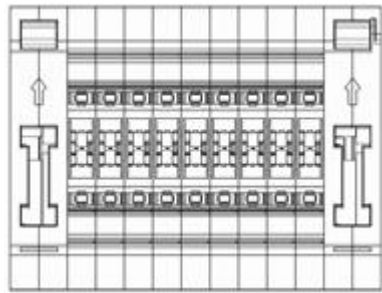

3.5

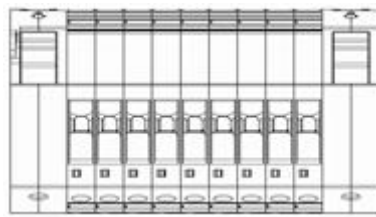

3.6

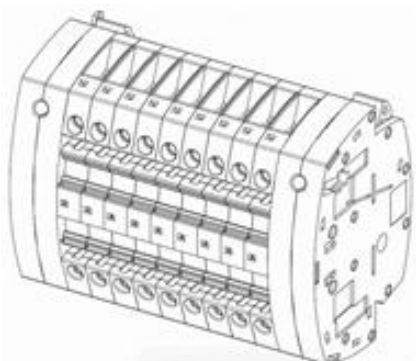

3.7

Design 4

- (54) **Produkt:** Electrical connectors
(51) **Klasse:** 13-03
(72) **Designer:** Dennis Habirov, Schloßhofstraße 30a, 33615 BIELEFELD, Tyskland (DE)
Christian Kloppenburg, Salzkottener Straße 48, 33142 BÜREN WEWELSBURG, Tyskland (DE)
Olaf Schyrocki, Fröbelstraße 10, 31812 BAD PYRMONT, Tyskland (DE)
(30) **Prioritet:** 2012.06.13, EM, 002057125
(55) **Designavbildninger:**

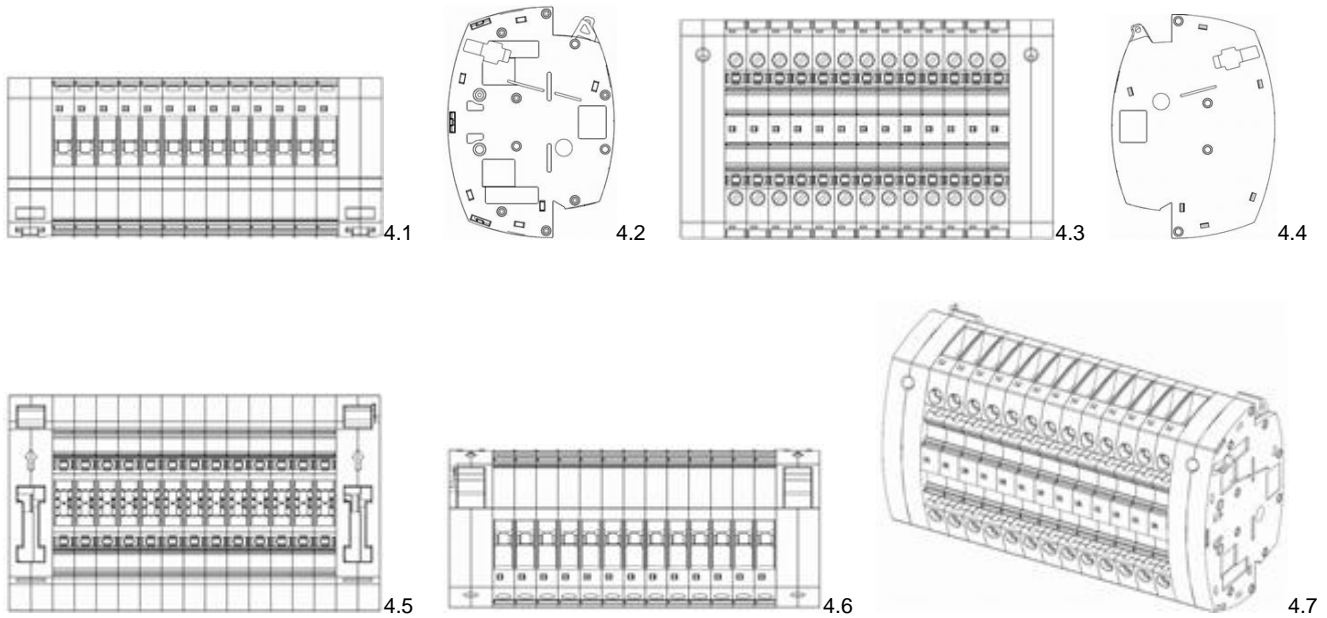

(11)	Reg.nr.:	DM/079768
(21)	Søkn.nr.:	20130076
(22)	Inngitt i WIPO:	2012.12.11
(15)	Registrert i WIPO:	2012.12.11
(24)	Løpedag:	2012.12.11
(43)	Allm. tilgj.:	2013.06.14
(15)	Besluttet gjeldende NO:	2013.06.20
(45)	Kunngjort NO:	2013.07.08
(18)	Reg. gjelder til:	2017.12.11
(73)	Innehaver:	Phoenix Contact GmbH & Co KG, Flachsmarktstraße 8, DE-32825 BLOMBERG, Tyskland
(50)	Anmerkninger:	Registreringen gjelder samregistrering.

Design 1

(54)	Produkt:	Electrical connectors
(51)	Klasse:	13-03
(72)	Designer:	Dennis Habirov, Schloßhofstraße 30a, 33615 BIELEFELD, Tyskland (DE) Christian Kloppenburg, Salzkottener Straße 48, 33142 BÜREN WEWELSBURG, Tyskland (DE) Olaf Schyrocki, Fröbelstraße 10, 31812 BAD PYRMONT, Tyskland (DE)
(30)	Prioritet:	2012.06.13, EM, 002057455
(55)	Designavbildninger:	

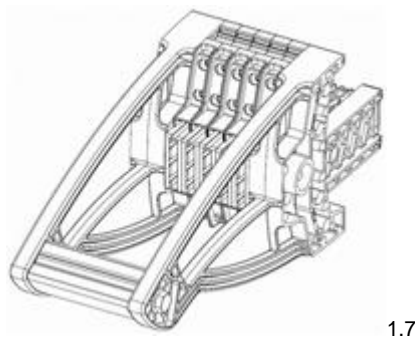
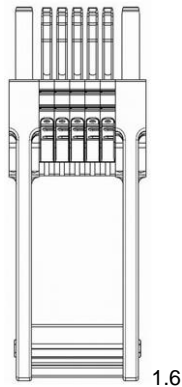
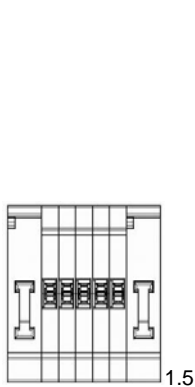
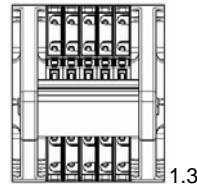
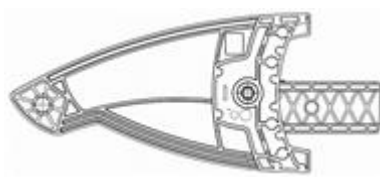
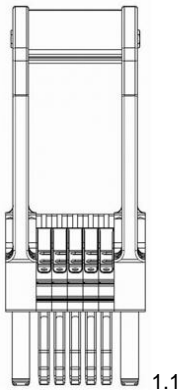

Design 2

- (54) **Produkt:** Electrical connectors
 (51) **Klasse:** 13-03
 (72) **Designer:** Dennis Habirov, Schloßhofstraße 30a, 33615 BIELEFELD, Tyskland (DE)
 Christian Kloppenburg, Salzkottener Straße 48, 33142 BÜREN WEWELSBURG, Tyskland (DE)
 Olaf Schyrocki, Fröbelstraße 10, 31812 BAD PYRMONT, Tyskland (DE)
 (30) **Prioritet:** 2012.06.13, EM, 002057455
 (55) **Designavbildninger:**

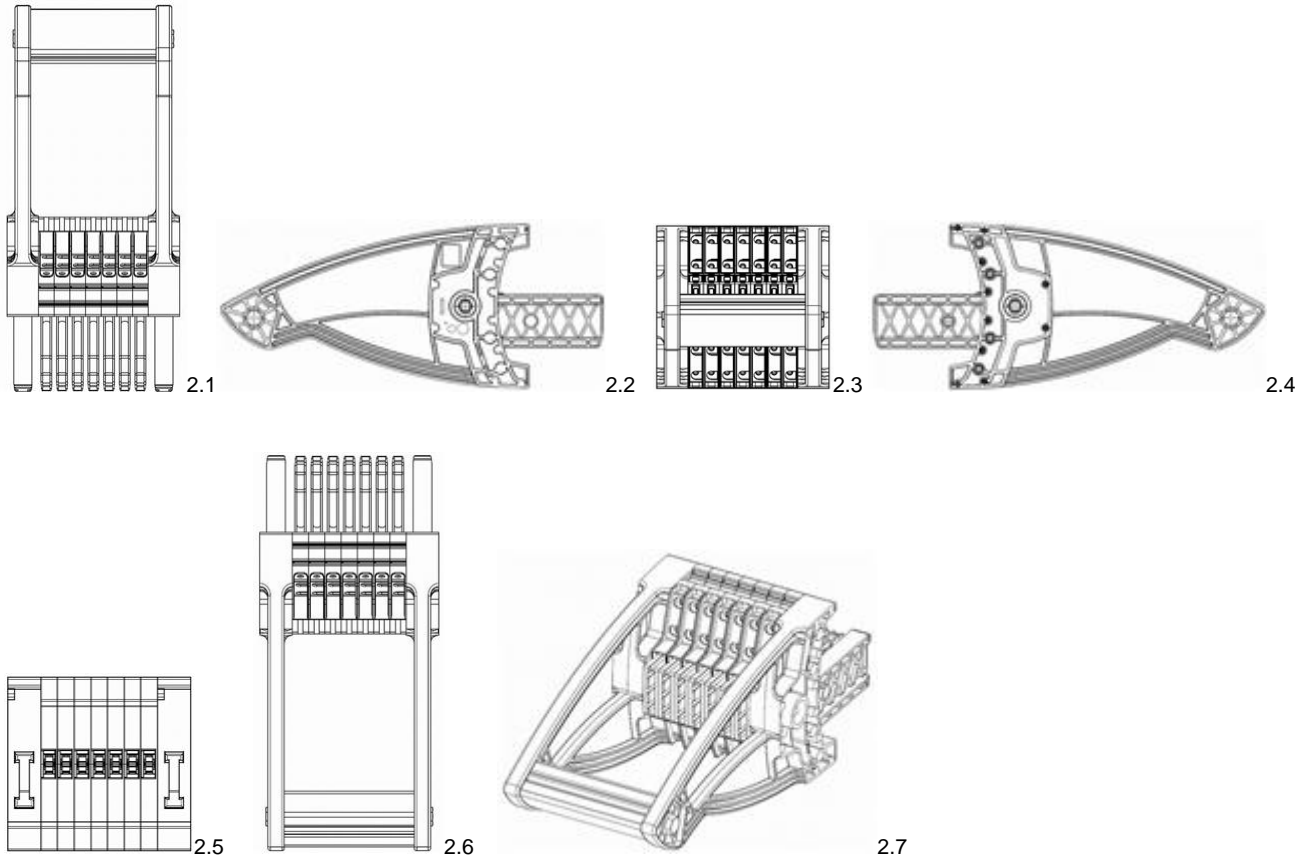
**Design 3**

- (54) **Produkt:** Electrical connectors
 (51) **Klasse:** 13-03
 (72) **Designer:** Dennis Habirov, Schloßhofstraße 30a, 33615 BIELEFELD, Tyskland (DE)
 Christian Kloppenburg, Salzkottener Straße 48, 33142 BÜREN WEWELSBURG, Tyskland (DE)
 Olaf Schyrocki, Fröbelstraße 10, 31812 BAD PYRMONT, Tyskland (DE)
 (30) **Prioritet:** 2012.06.13, EM, 002057455
 (55) **Designavbildninger:**

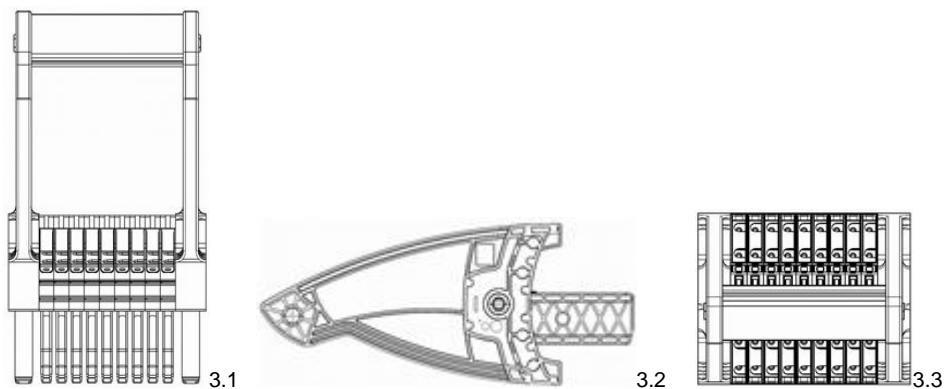



3.4

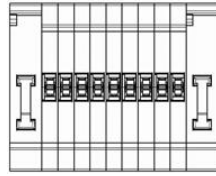

3.5

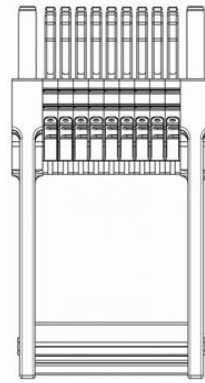

3.6

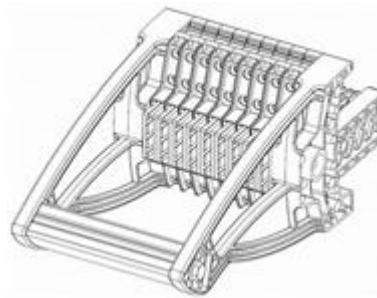

3.7

Design 4

- (54) **Produkt:** Electrical connectors
- (51) **Klasse:** 13-03
- (72) **Designer:** Dennis Habirov, Schloßhofstraße 30a, 33615 BIELEFELD, Tyskland (DE)
Christian Kloppenburg, Salzkottener Straße 48, 33142 BÜREN WEWELSBURG, Tyskland (DE)
Olaf Schyrocki, Fröbelstraße 10, 31812 BAD PYRMONT, Tyskland (DE)
- (30) **Prioritet:** 2012.06.13, EM, 002057455
- (55) **Designavbildninger:**

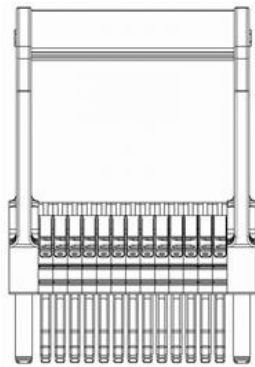

4.1

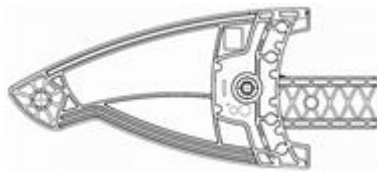

4.2

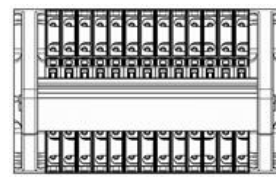

4.3



4.4

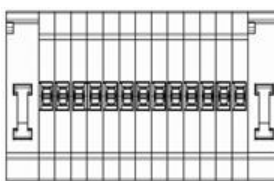

4.5

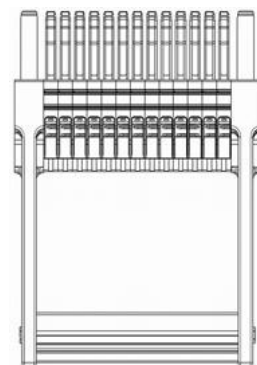

4.6

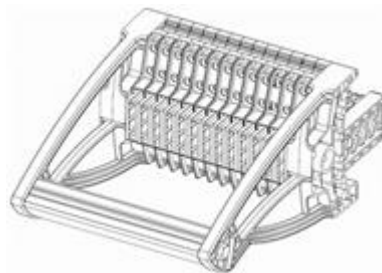

4.7

(11)	Reg.nr.:	DM/079769
(21)	Søkn.nr.:	20130077
(22)	Inngitt i WIPO:	2012.12.11
(15)	Registrert i WIPO:	2012.12.11
(24)	Løpedag:	2012.12.11
(43)	Allm. tilgj.:	2013.06.14
(15)	Besluttet gjeldende NO:	2013.06.20
(45)	Kunngjort NO:	2013.07.08
(18)	Reg. gjelder til:	2017.12.11
(73)	Innehaver:	Phoenix Contact GmbH & Co KG, Flachsmarktstraße 8, DE-32825 BLOMBERG, Tyskland
(50)	Anmerkninger:	Registreringen gjelder samregistrering.

Design 1

(54)	Produkt:	Electrical connectors
(51)	Klasse:	13-03
(72)	Designer:	Dennis Habirov, Schloßhofstraße 30a, 33615 BIELEFELD, Tyskland (DE) Christian Kloppenburg, Salzkottener Straße 48, 33142 BÜREN WEWELSBURG, Tyskland (DE) Olaf Schyrocki, Fröbelstraße 10, 31812 BAD PYRMONT, Tyskland (DE)
(30)	Prioritet:	2012.06.13, EM, 002057463
(55)	Designavbildninger:	

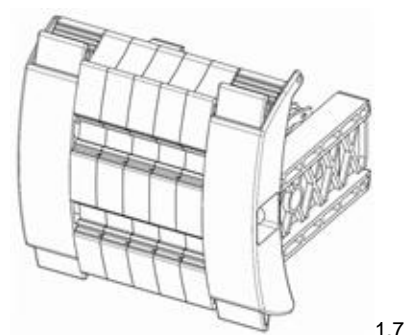
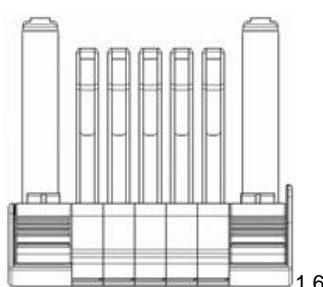
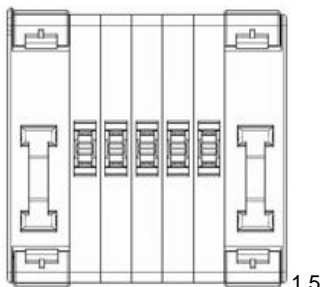
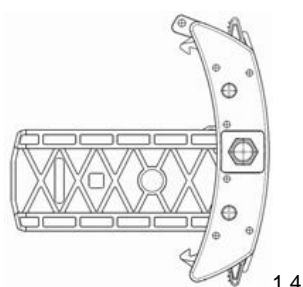
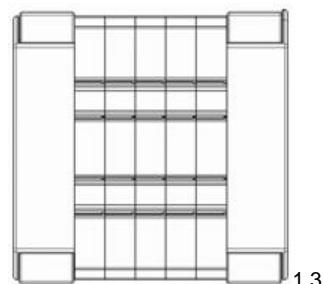
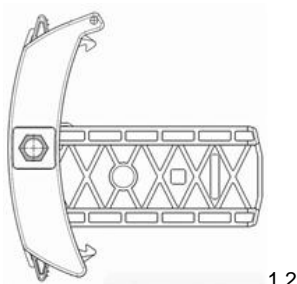
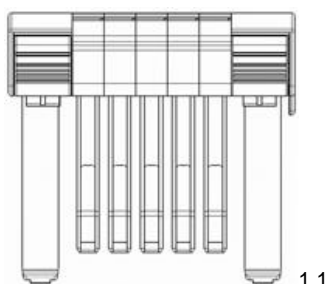

Design 2

- (54) **Produkt:** Electrical connectors
 (51) **Klasse:** 13-03
 (72) **Designer:** Dennis Habirov, Schloßhofstraße 30a, 33615 BIELEFELD, Tyskland (DE)
 Christian Kloppenburg, Salzkottener Straße 48, 33142 BÜREN WEWELSBURG, Tyskland (DE)
 Olaf Schyrocki, Fröbelstraße 10, 31812 BAD PYRMONT, Tyskland (DE)
 (30) **Prioritet:** 2012.06.13, EM, 002057463
 (55) **Designavbildninger:**

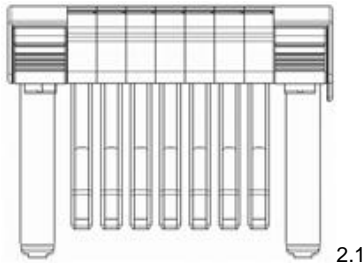

2.1

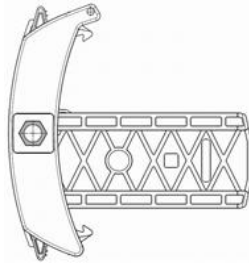

2.2

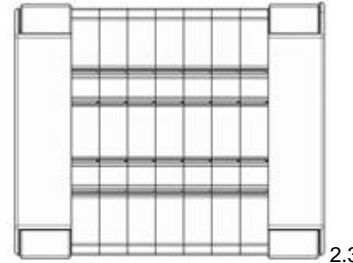

2.3

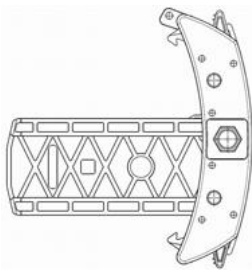

2.4

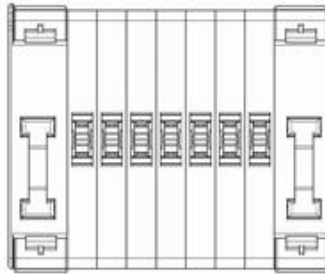

2.5

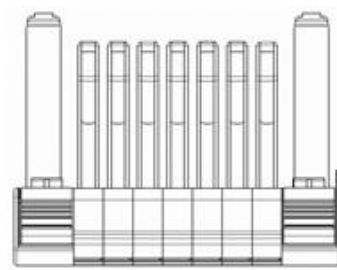

2.6

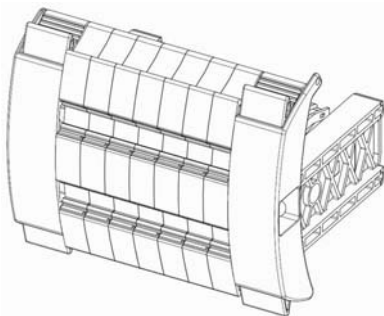

2.7

Design 3

- (54) **Produkt:** Electrical connectors
 (51) **Klasse:** 13-03
 (72) **Designer:** Dennis Habirov, Schloßhofstraße 30a, 33615 BIELEFELD, Tyskland (DE)
 Christian Kloppenburg, Salzkottener Straße 48, 33142 BÜREN WEWELSBURG, Tyskland (DE)
 Olaf Schyrocki, Fröbelstraße 10, 31812 BAD PYRMONT, Tyskland (DE)
 (30) **Prioritet:** 2012.06.13, EM, 002057463
 (55) **Designavbildninger:**

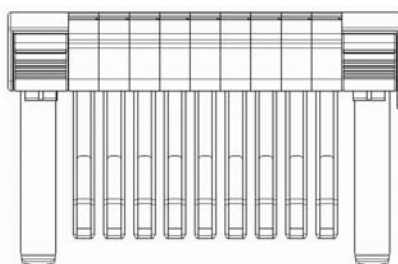

3.1

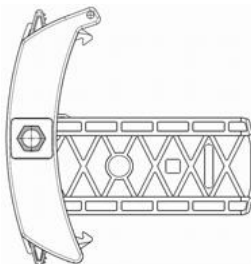

3.2

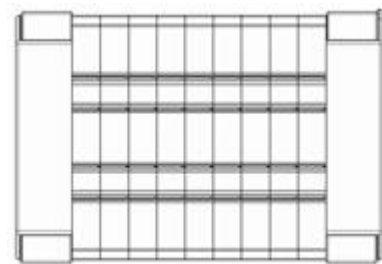

3.3

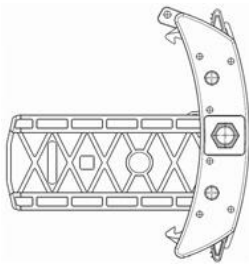

3.4

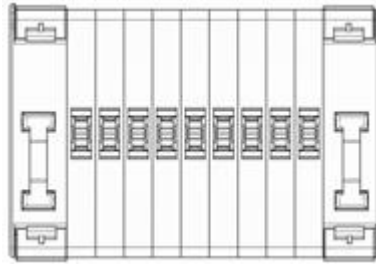

3.5

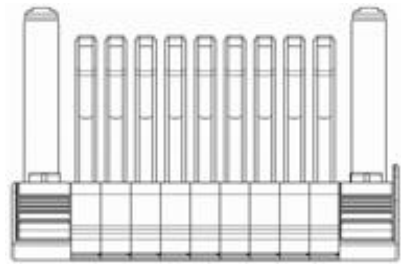

3.6

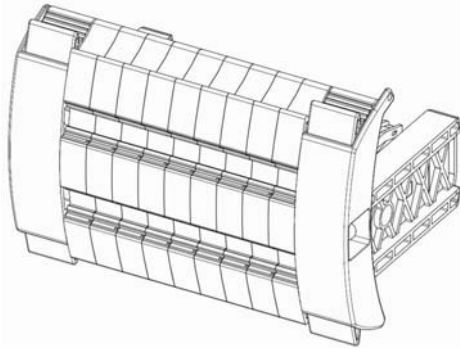

3.7

Design 4

- (54) **Produkt:** Electrical connectors
- (51) **Klasse:** 13-03
- (72) **Designer:** Dennis Habirov, Schloßhofstraße 30a, 33615 BIELEFELD, Tyskland (DE)
Christian Kloppenburg, Salzkottener Straße 48, 33142 BÜREN WEWELSBURG, Tyskland (DE)
Olaf Schyrocki, Fröbelstraße 10, 31812 BAD PYRMONT, Tyskland (DE)
- (30) **Prioritet:** 2012.06.13, EM, 002057463
- (55) **Designavbildninger:**

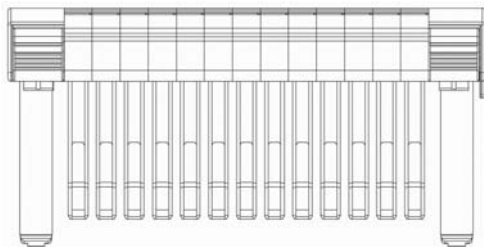

4.1

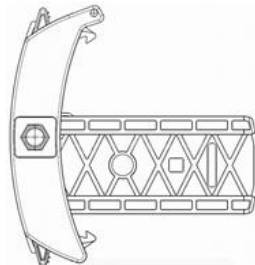

4.2

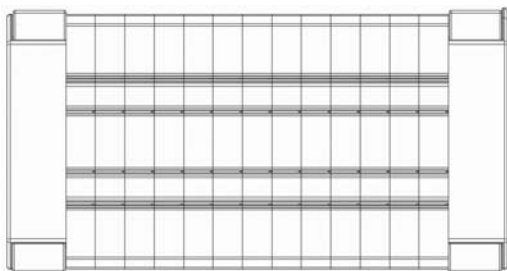

4.3

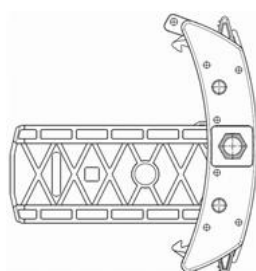

4.4

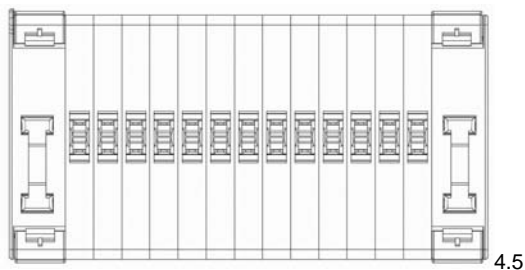

4.5

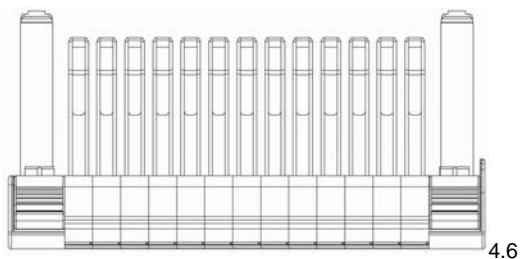

4.6

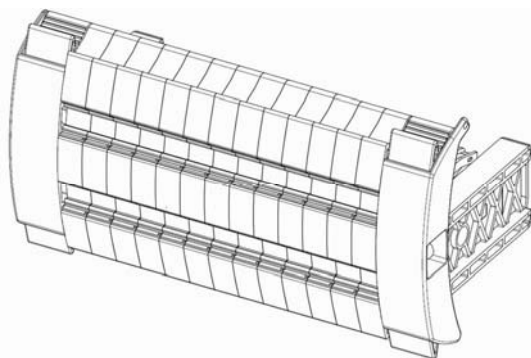

4.7

Design 5

- (54) **Produkt:** Electrical connectors
- (51) **Klasse:** 13-03
- (72) **Designer:** Dennis Habirov, Schloßhofstraße 30a, 33615 BIELEFELD, Tyskland (DE)
Christian Kloppenburg, Salzkottener Straße 48, 33142 BÜREN WEWELSBURG, Tyskland (DE)
Olaf Schyrocki, Fröbelstraße 10, 31812 BAD PYRMONT, Tyskland (DE)
- (30) **Prioritet:** 2012.06.13, EM, 002057463
- (55) **Designavbildninger:**

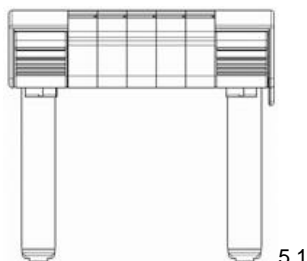

5.1

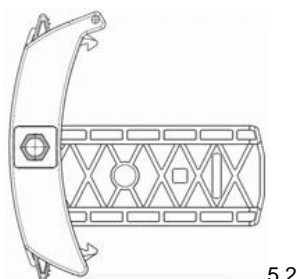

5.2

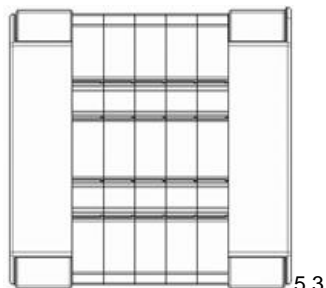

5.3

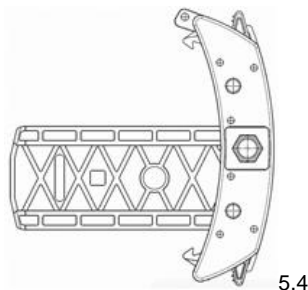

5.4

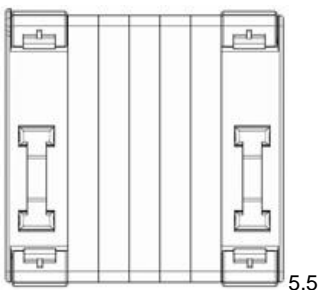

5.5

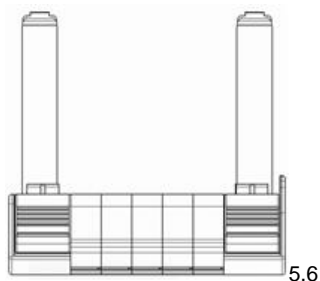

5.6

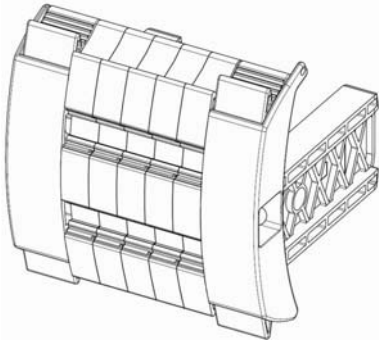

5.7

Design 6

(54) **Produkt:** Electrical connectors
 (51) **Klasse:** 13-03
 (72) **Designer:** Dennis Habirov, Schloßhofstraße 30a, 33615 BIELEFELD, Tyskland (DE)
 Christian Kloppenburg, Salzkottener Straße 48, 33142 BÜREN WEWELSBURG, Tyskland (DE)
 Olaf Schyrocki, Fröbelstraße 10, 31812 BAD PYRMONT, Tyskland (DE)
 (30) **Prioritet:** 2012.06.13, EM, 002057463
 (55) **Designavbildninger:**

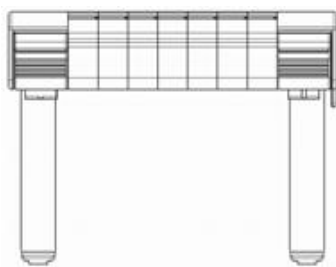

6.1

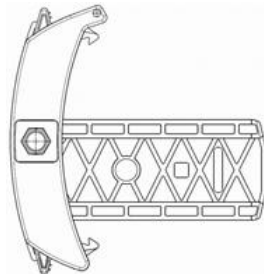

6.2

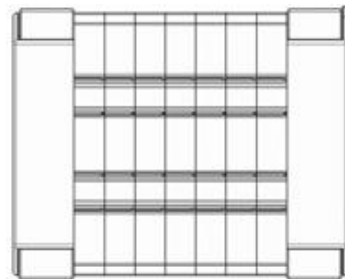

6.3

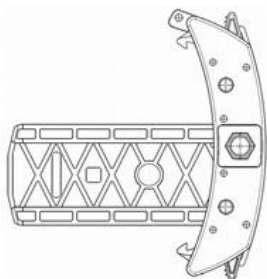

6.4

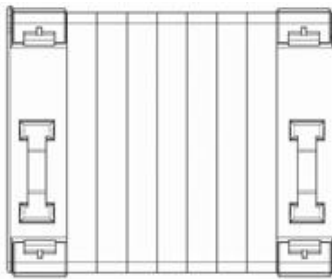

6.5

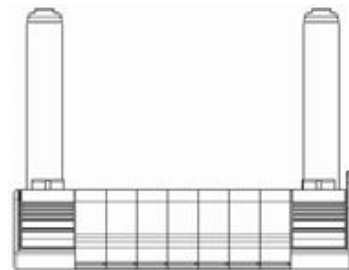

6.6

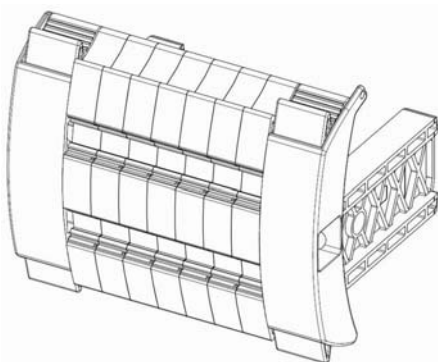

6.7

Design 7

- (54) **Produkt:** Electrical connectors
(51) **Klasse:** 13-03
(72) **Designer:** Dennis Habirov, Schloßhofstraße 30a, 33615 BIELEFELD, Tyskland (DE)
Christian Kloppenburg, Salzkottener Straße 48, 33142 BÜREN WEWELSBURG, Tyskland (DE)
Olaf Schyrocki, Fröbelstraße 10, 31812 BAD PYRMONT, Tyskland (DE)
(30) **Prioritet:** 2012.06.13, EM, 002057463
(55) **Designavbildninger:**

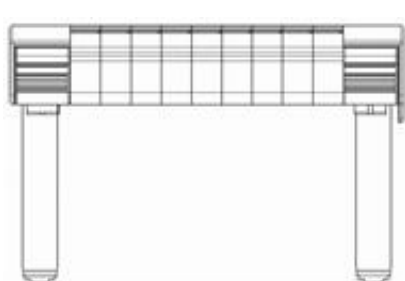

7.1

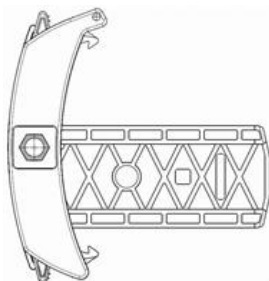

7.2

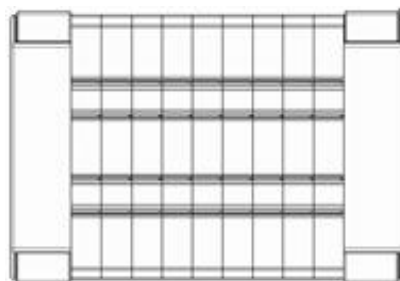

7.3

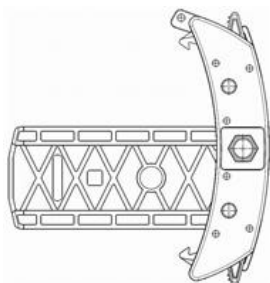

7.4

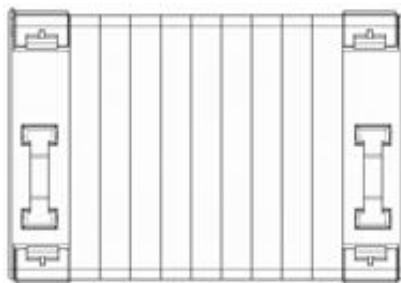

7.5

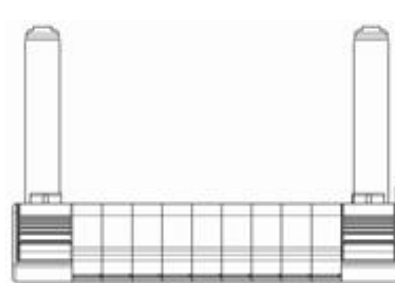

7.6

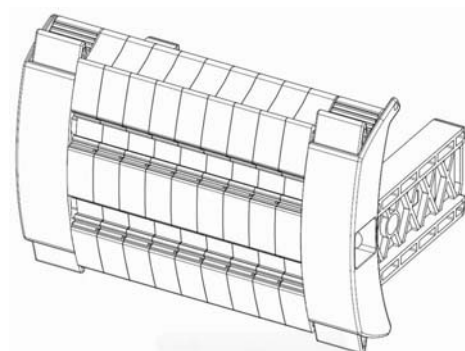

7.7

Design 8

- (54) **Produkt:** Electrical connectors
(51) **Klasse:** 13-03
(72) **Designer:** Dennis Habirov, Schloßhofstraße 30a, 33615 BIELEFELD, Tyskland (DE)
Christian Kloppenburg, Salzkottener Straße 48, 33142 BÜREN WEWELSBURG, Tyskland (DE)
Olaf Schyrocki, Fröbelstraße 10, 31812 BAD PYRMONT, Tyskland (DE)
(30) **Prioritet:** 2012.06.13, EM, 002057463
(55) **Designavbildninger:**

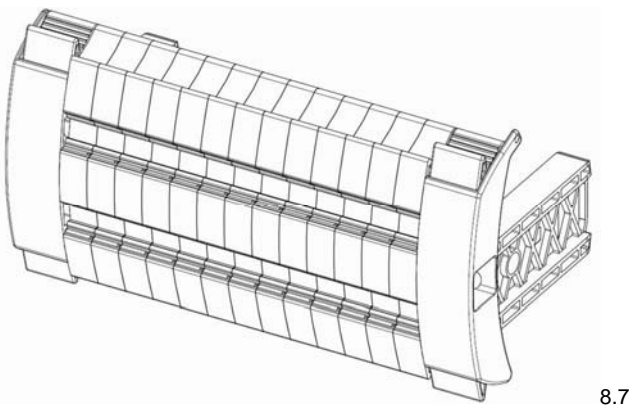
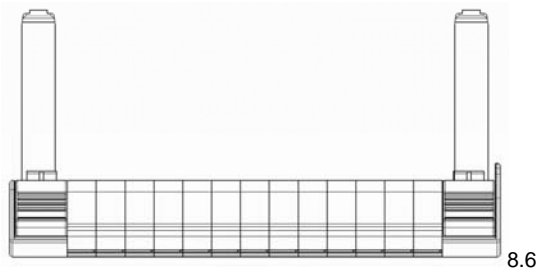
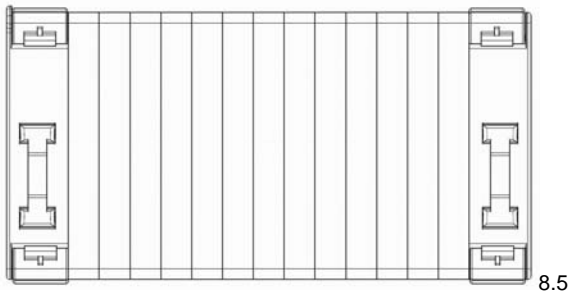
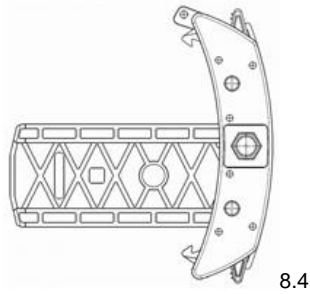
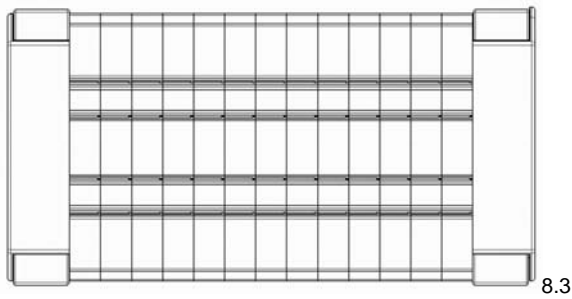
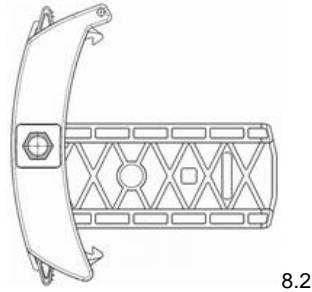
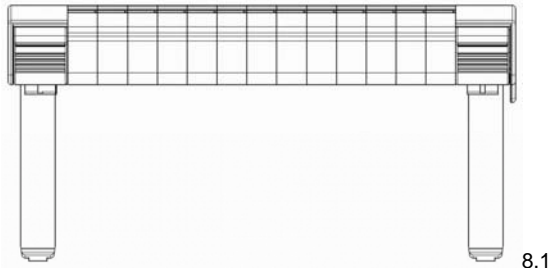

(11)	Reg.nr.:	DM/079910
(21)	Søkn.nr.:	20130171
(22)	Inngitt i WIPO:	2012.12.11
(15)	Registrert i WIPO:	2012.12.11
(24)	Løpedag:	2012.12.11
(43)	Allm. tilgj.:	2013.01.25
(15)	Besluttet gjeldende NO:	2013.06.18
(45)	Kunngjort NO:	2013.07.08
(18)	Reg. gjelder til:	2017.12.11
(73)	Innehaver:	Gundars Jansons, Birzes street 1-30, Cesis, LV-4100 CESU REG, Latvia Andrejs Mikelsons, Mezvidu street 5, Skulte, LV-2166 MARUPES REG, Latvia
(50)	Anmerkninger:	Designen er i farger.

Design 1

(54)	Produkt:	Goalie mask
(51)	Klasse:	21-02
(50)	Anmerkning:	Designen er i farger.
(55)	Designavbildninger:	



(11)	Reg.nr.:	DM/079934
(21)	Søkn.nr.:	20130180
(22)	Inngitt i WIPO:	2012.11.23
(15)	Registrert i WIPO:	2012.11.23
(24)	Løpedag:	2012.11.23
(43)	Allm. tilgj.:	2013.05.24
(15)	Besluttet gjeldende NO:	2013.06.10
(45)	Kunngjort NO:	2013.07.08
(18)	Reg. gjelder til:	2017.11.23
(73)	Innehaver:	Martine Thoelen, Käppelistrasse 15, CH-6045 MEGGEN, Sveits

Design 1

(54)	Produkt:	Candle holder
(51)	Klasse:	26-01
(72)	Designer:	Martine Thoelen, Käppelistrasse 15, 6045 MEGGEN, Sveits (CH)
(55)	Designavbildninger:	



1.1



1.2

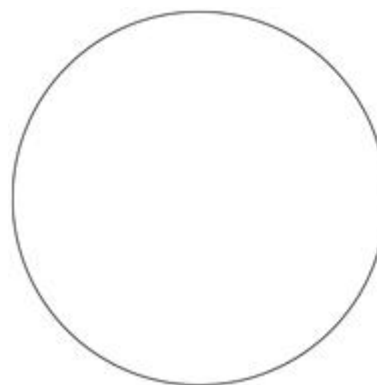

1.3



1.4



1.5



1.6



1.7

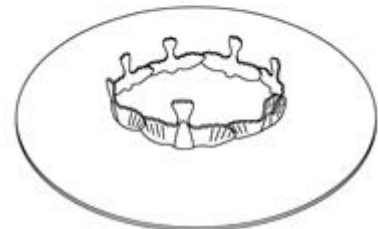

1.8

(11)	Reg.nr.:	DM/080011
(21)	Søkn.nr.:	20130262
(22)	Inngitt i WIPO:	2012.10.10
(15)	Registrert i WIPO:	2012.10.10
(24)	Løpedag:	2012.10.10
(43)	Allm. tilgj.:	2013.02.08
(15)	Besluttet gjeldende NO:	2013.06.18
(45)	Kunngjort NO:	2013.07.08
(18)	Reg. gjelder til:	2017.10.10
(73)	Innehaver:	ABC Participations, 1 avenue des Marronniers, Zone des petits Carreaux, FR-94386 BONNEUIL SUR MARNE CEDEX, Frankrike
(50)	Anmerkninger:	Registreringen gjelder samregistrering.

Design 1

(54)	Produkt:	Cuticle cutter
(51)	Klasse:	28-03
(55)	Designavbildninger:	

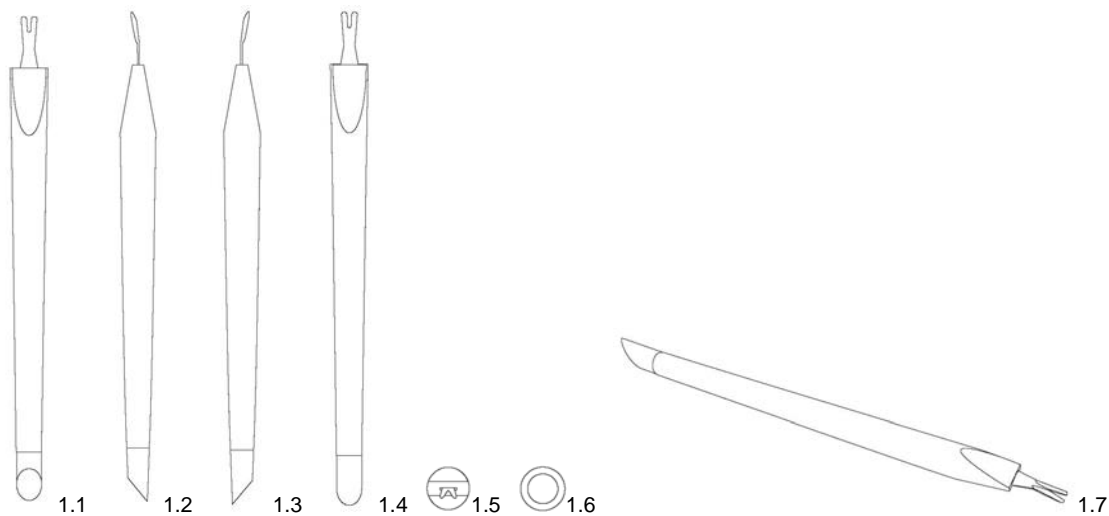
**Design 2**

(54)	Produkt:	Metal file
(51)	Klasse:	28-03
(55)	Designavbildninger:	

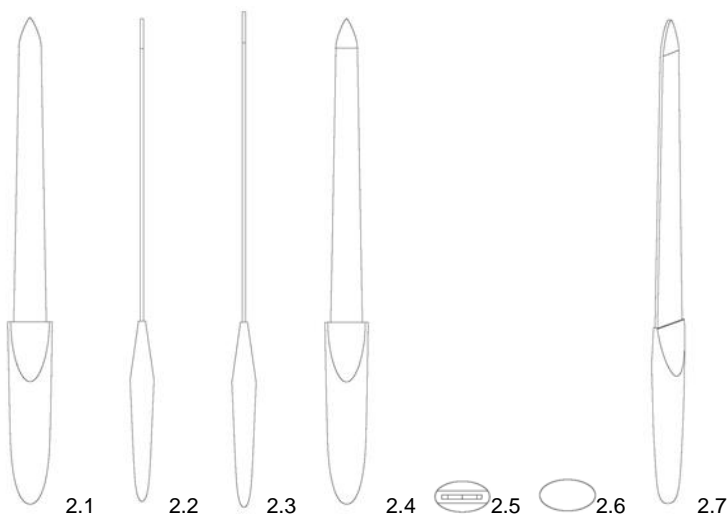

Design 3

(54) **Produkt:** Nail clippers
 (51) **Klasse:** 28-03
 (55) **Designavbildninger:**

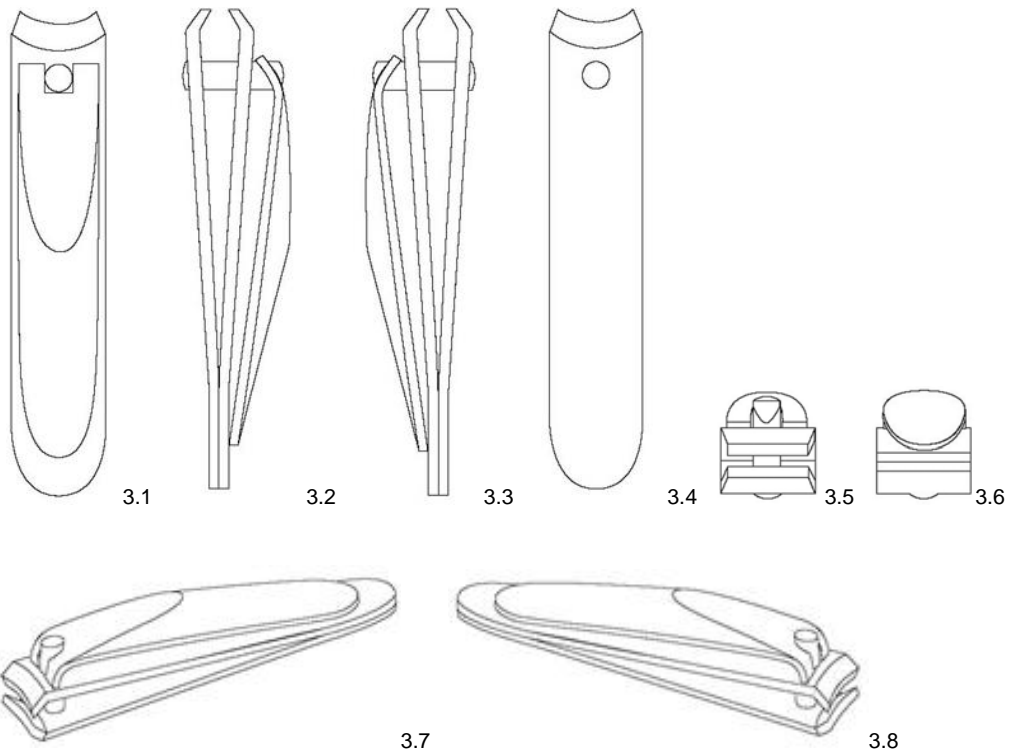

Design 4

(54) **Produkt:** Pedicure file
 (51) **Klasse:** 28-03
 (55) **Designavbildninger:**

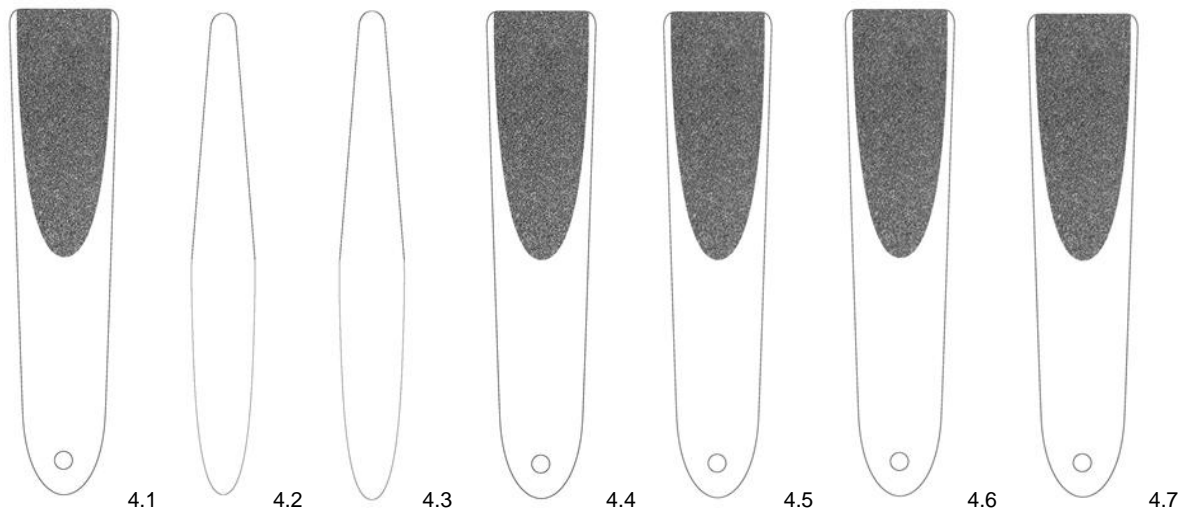

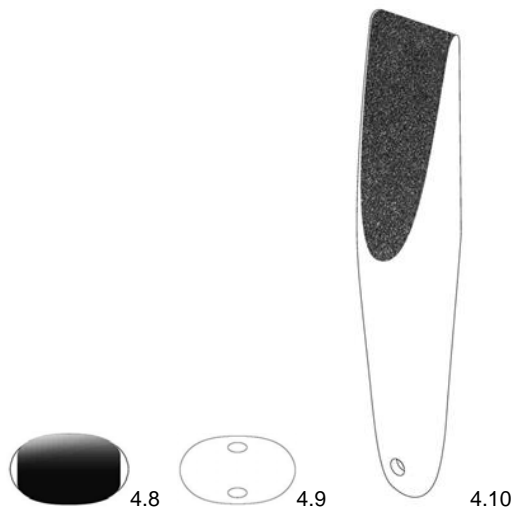

Design 5

(54) **Produkt:** Tweezers
 (51) **Klasse:** 28-03
 (55) **Designavbildninger:**

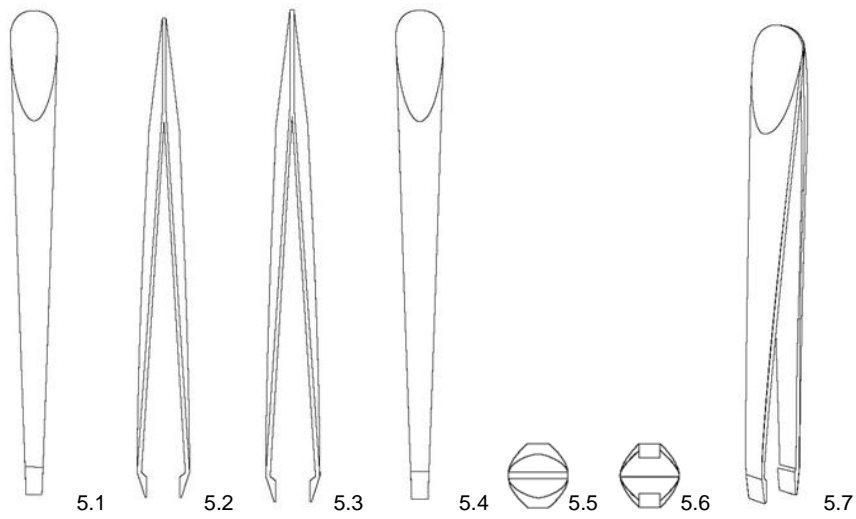

(11)	Reg.nr.:	DM/080012
(21)	Søkn.nr.:	20130263
(22)	Inngitt i WIPO:	2012.10.10
(15)	Registrert i WIPO:	2012.10.10
(24)	Løpedag:	2012.10.10
(43)	Allm. tilgj.:	2013.02.08
(15)	Besluttet gjeldende NO:	2013.06.18
(45)	Kunngjort NO:	2013.07.08
(18)	Reg. gjelder til:	2017.10.10
(73)	Innehaver:	ABC Participations, 1 avenue des Marronniers, Zone des petits Carreaux, FR-94386 BONNEUIL SUR MARNE CEDEX, Frankrike

Design 1

(54)	Produkt:	Nail brush
(51)	Klasse:	04-02
(55)	Designavbildninger:	

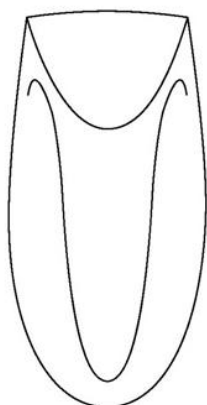

1.1

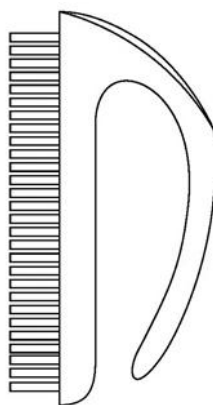

1.2

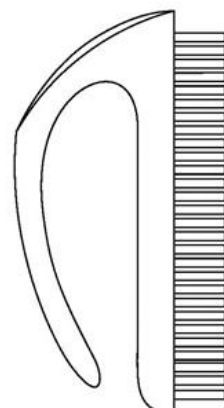

1.3

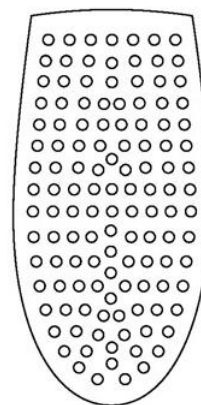

1.4

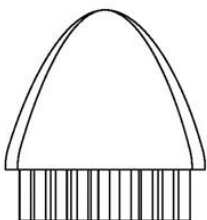

1.5

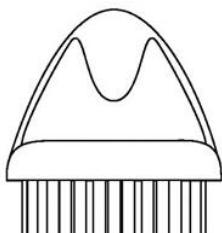

1.6

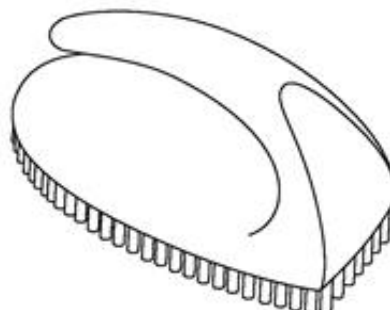

1.7

(11)	Reg.nr.:	DM/080391
(21)	Søkn.nr.:	20130398
(22)	Inngitt i WIPO:	2013.01.30
(15)	Registrert i WIPO:	2013.01.30
(24)	Løpedag:	2013.01.30
(43)	Allm. tilgj.:	2013.04.05
(15)	Besluttet gjeldende NO:	2013.06.10
(45)	Kunngjort NO:	2013.07.08
(18)	Reg. gjelder til:	2018.01.30
(73)	Innehaver:	Guillaume Patrois, 55 avenue Marceau, FR-75016 PARIS, Frankrike
(50)	Anmerkninger:	Registreringen gjelder samregistrering.

Design 1

(54)	Produkt:	Protection systems for two-wheelers
(51)	Klasse:	12-16
(72)	Designer:	Guillaume Patrois, 55 avenue Marceau, 75016 PARIS, Frankrike (FR)
(55)	Designavbildninger:	



1.1



1.2



1.3

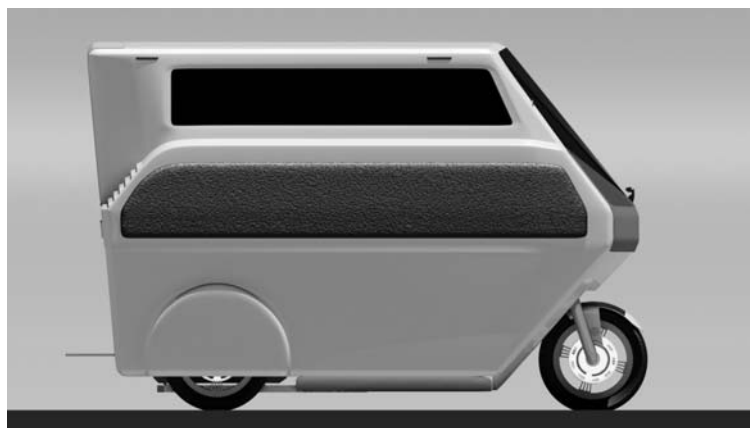

1.4



1.5

Design 2

(54)	Produkt:	Protection systems for two-wheelers
(51)	Klasse:	12-16
(72)	Designer:	Guillaume Patrois, 55 avenue Marceau, 75016 PARIS, Frankrike (FR)
(55)	Designavbildninger:	

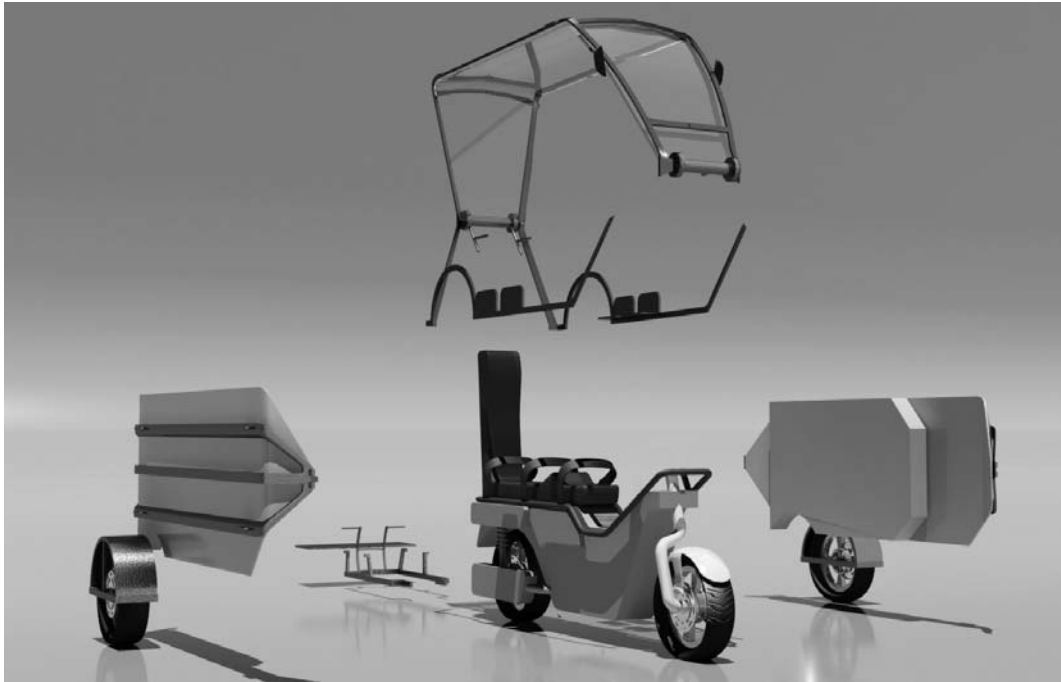

2.1

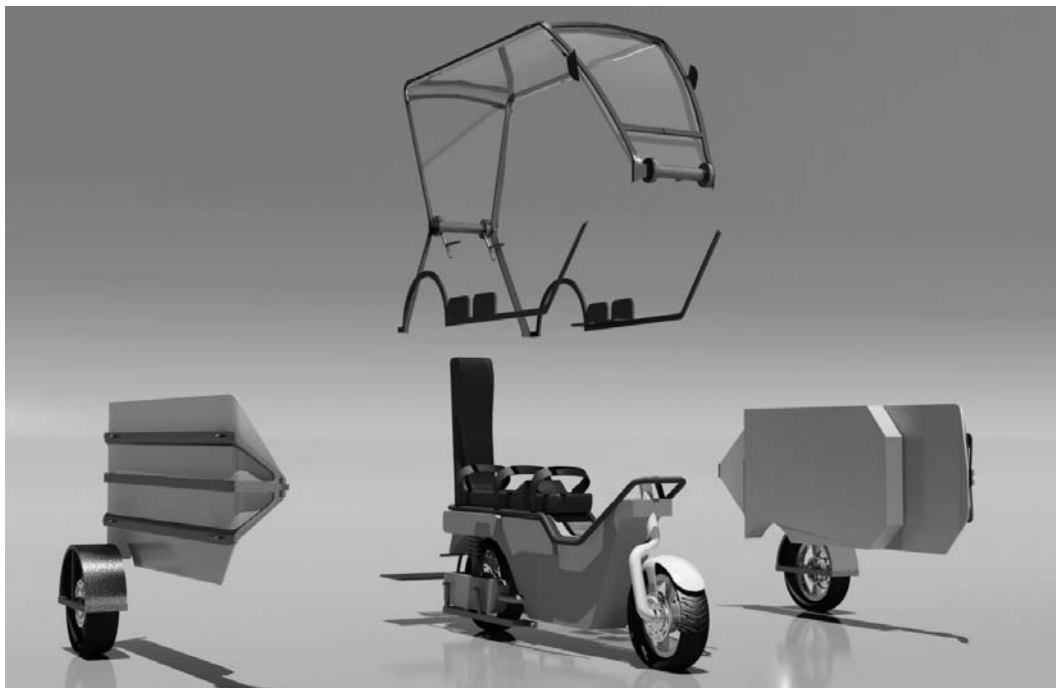

2.2

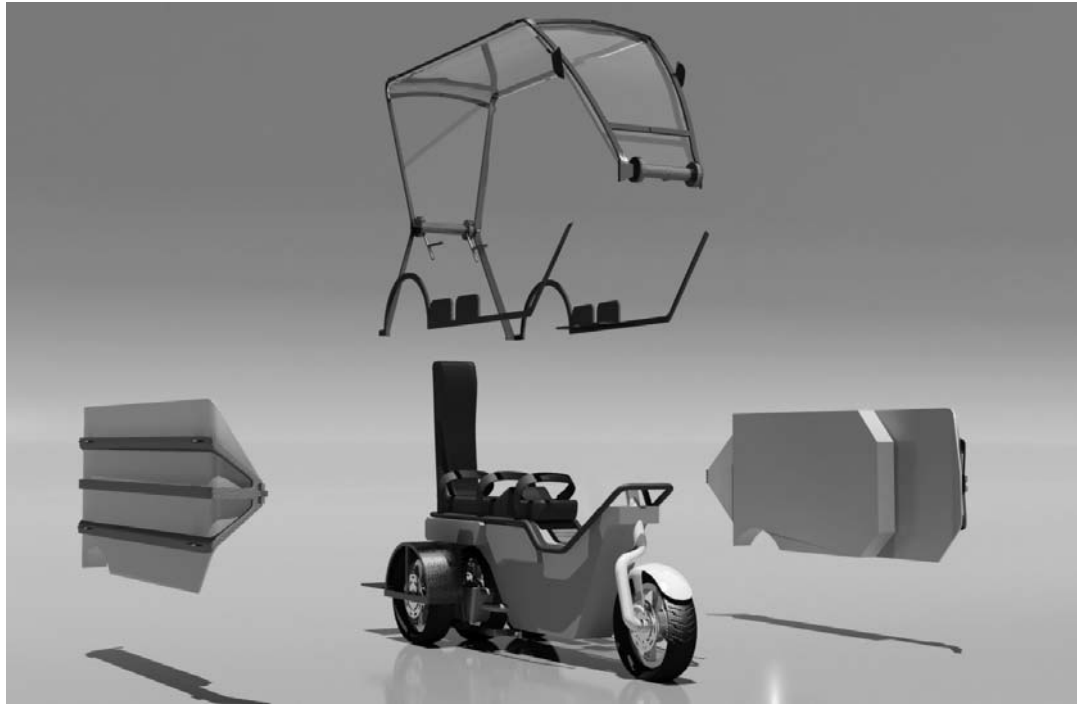

2.3



2.4



2.5

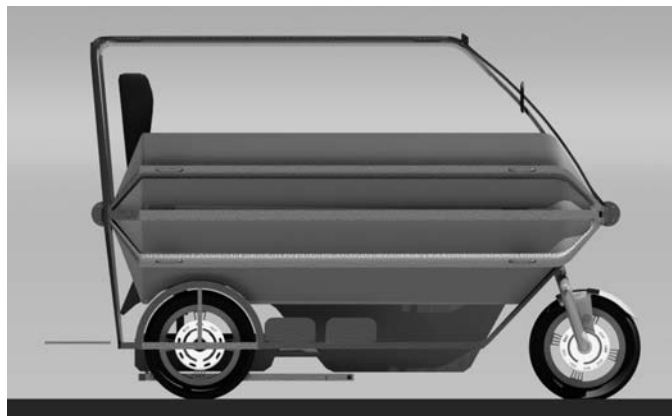

2.6



2.7



2.8

(11)	Reg.nr.:	DM/080399
(21)	Søkn.nr.:	20130401
(22)	Inngitt i WIPO:	2013.03.14
(15)	Registrert i WIPO:	2013.03.14
(24)	Løpedag:	2013.03.14
(43)	Allm. tilgj.:	2013.04.05
(15)	Besluttet gjeldende NO:	2013.06.10
(45)	Kunngjort NO:	2013.07.08
(18)	Reg. gjelder til:	2018.03.14
(73)	Innehaver:	Blancpain SA, Le Rocher 12, CH-1348 LE BRASSUS, Sveits
(50)	Anmerkninger:	Registreringen gjelder samregistrering.

Design 1

(54)	Produkt:	Watches
(51)	Klasse:	10-02
(72)	Designer:	Alan Apprederisse, Av. du Léman 48, 1005 LAUSANNE, Sveits (CH)
(55)	Designavbildninger:	

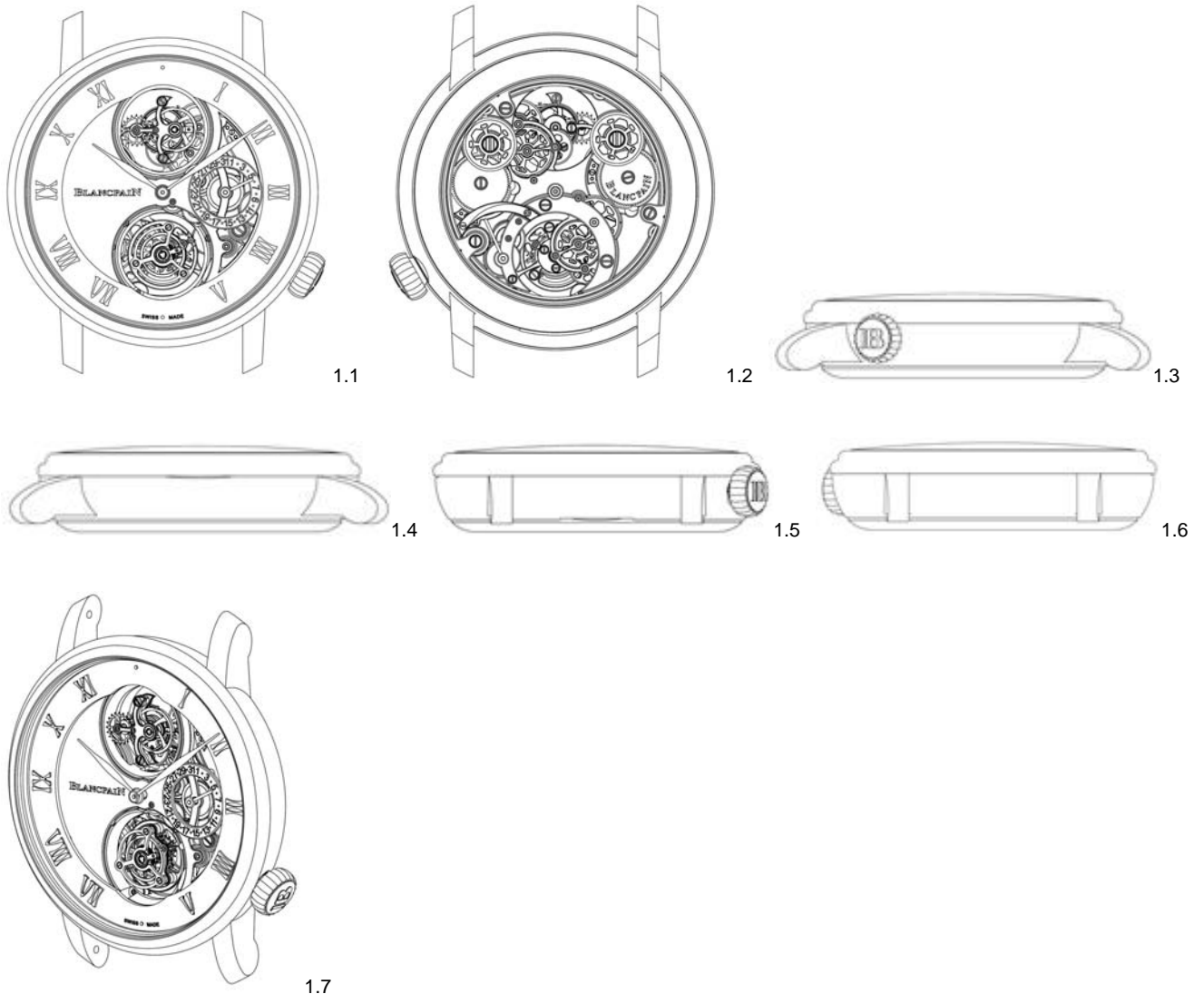

Design 2

- (54) **Produkt:** Watches
- (51) **Klasse:** 10-02
- (72) **Designer:** Patrice Nanga, Avenue Dapples 26, 1006 LAUSANNE, Sveits (CH)
- (55) **Designavbildninger:**



2.1



2.2



2.3

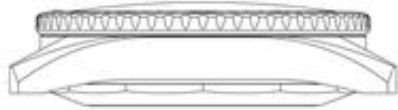

2.4

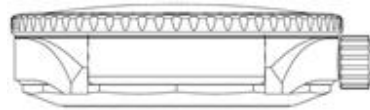

2.5

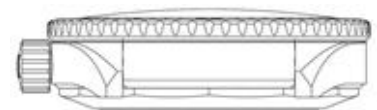

2.6



2.7

Design 3

- (54) **Produkt:** Watches
- (51) **Klasse:** 10-02
- (72) **Designer:** Patrice Nanga, Avenue Dapples 26, 1006 LAUSANNE, Sveits (CH)
- (55) **Designavbildninger:**



3.1

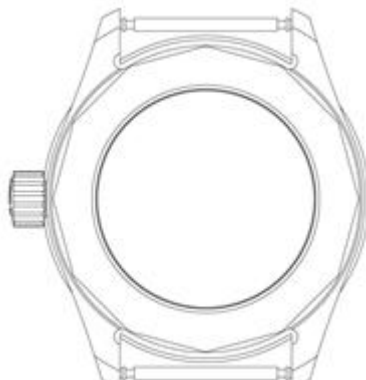

3.2



3.3



3.4

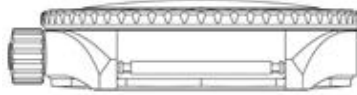

3.5

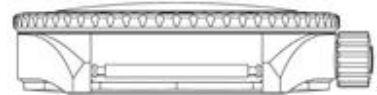

3.6



3.7

(11)	Reg.nr.:	DM/080411
(21)	Søkn.nr.:	20130407
(22)	Inngitt i WIPO:	2013.02.13
(15)	Registrert i WIPO:	2013.02.13
(24)	Løpedag:	2013.02.13
(43)	Allm. tilgj.:	2013.04.05
(15)	Besluttet gjeldende NO:	2013.06.10
(45)	Kunngjort NO:	2013.07.08
(18)	Reg. gjelder til:	2018.02.13
(73)	Innehaver:	Vidar Skavland, 4163 TALGJE, Norge

Design 1

(54)	Produkt:	Ramp line (activity apparatus)
(51)	Klasse:	21-02
(72)	Designer:	Vidar Skavland, 4163 TALGJE
(55)	Designavbildninger:	

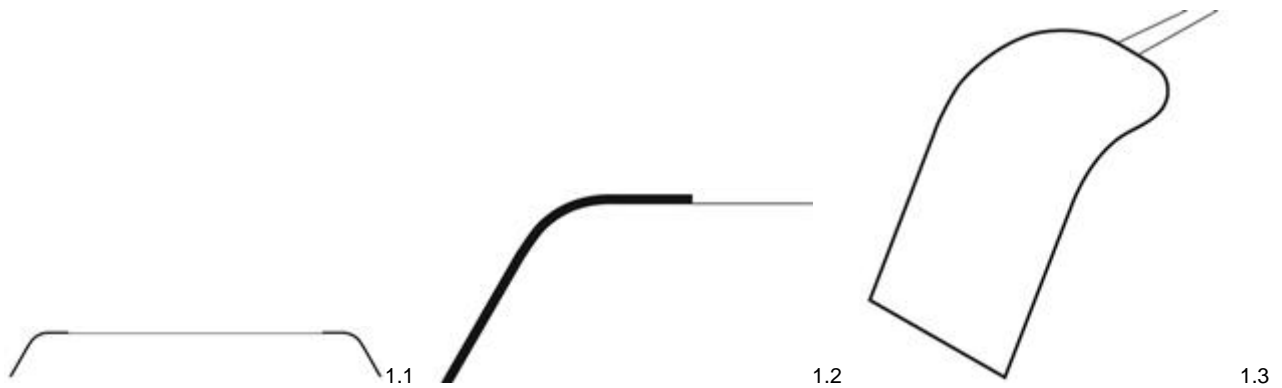

(11)	Reg.nr.:	DM/080433
(21)	Søkn.nr.:	20130415
(22)	Inngitt i WIPO:	2013.03.21
(15)	Registrert i WIPO:	2013.03.21
(24)	Løpedag:	2013.03.21
(43)	Allm. tilgj.:	2013.04.05
(15)	Besluttet gjeldende NO:	2013.06.11
(45)	Kunngjort NO:	2013.07.08
(18)	Reg. gjelder til:	2018.03.21
(73)	Innehaver:	L'OREAL (UK) Ltd, Hammersmith Road 255, GB-VV68AZ LONDON, Storbritannia
(50)	Anmerkninger:	Designen er i farger.

Design 1

(54)	Produkt:	Pots for cosmetic products
(51)	Klasse:	09-01
(72)	Designer:	Lawrence Noe Duchaufour, 8 Passage de la Bonne Graine, 75011 PARIS, Frankrike (FR)
(30)	Prioritet:	2012.12.27, EM, 002159939-0001
(55)	Designavbildninger:	



1.1



1.2



1.3



1.4

Overdragelser

- (11) **Reg.nr.:** 076942
(21) **Søknadsnr.** 20010387
(73) **Innehaver:** Xylem Water Solutions
Manufacturing AB,
Luxembourg Branc, 9, rue
Gabriel Lippman, LU-5365
MUNSBACH, Luxembourg
(74) **Fullmektig:** Zacco Norway AS, Postboks
2003 Vika, 0125 OSLO, Norge
-

- (11) **Reg.nr.:** 076943
(21) **Søknadsnr.** 20010388
(73) **Innehaver:** Xylem Water Solutions
Manufacturing AB,
Luxembourg Branc, 9, rue
Gabriel Lippman, LU-5365
MUNSBACH, Luxembourg
(74) **Fullmektig:** Zacco Norway AS, Postboks
2003 Vika, 0125 OSLO, Norge
-

- (11) **Reg.nr.:** 076944
(21) **Søknadsnr.** 20010389
(73) **Innehaver:** Xylem Water Solutions
Manufacturing AB,
Luxembourg Branc, 9, rue
Gabriel Lippman, LU-5365
MUNSBACH, Luxembourg
(74) **Fullmektig:** Zacco Norway AS, Postboks
2003 Vika, 0125 OSLO, Norge
-

- (11) **Reg.nr.:** 078354
(21) **Søknadsnr.** 20030407
(73) **Innehaver:** INFRALOGIQ AS,
Myrvangveien 6, 4016
STAVANGER, Norge
-

- (11) **Reg.nr.:** 081716
(21) **Søknadsnr.** 20080594
(73) **Innehaver:** Ann Isabelle Bjørnholt,
Turstien 8, 1479 KURLAND,
Norge
-

Fornyelse av registreringer

(11)	Reg.nr:	071979	Fornyhet til:	2018.12.29
(73)	Innehaver:	Tentipi AB , Abmorvägen 38, 93086, MOSKOSEL, SE		
(74)	Fullmektig:	Curo AS , Industriveien 53, 7080, HEIMDAL, NO		

(11)	Reg.nr:	075311	Fornyhet til:	2018.08.12
(73)	Innehaver:	Rittal-Werk Rudolf Loh GmbH & Co KG , Auf dem Stützelberg, 35745, HERBORN, DE		
(74)	Fullmektig:	Onsagers AS , Postboks 1813 Vika, 0123, OSLO, NO		

(11)	Reg.nr:	077709	Fornyhet til:	2018.08.06
(73)	Innehaver:	Inter Ikea Systems BV , Olof Palmestraat 1, 2616LN Delft, NL		
(74)	Fullmektig:	Onsagers AS , Postboks 1813 Vika, 0123, OSLO, NO		

(11)	Reg.nr:	077934	Fornyhet til:	2018.06.25
(73)	Innehaver:	Sutter Finanziaria SpA , Località Leigozze, 1, I-15060 Borghetto Borbera AL, IT		
(74)	Fullmektig:	Bryn Aarflot AS , Postboks 449 Sentrum, 0104, OSLO, NO		

(11)	Reg.nr:	081101	Fornyhet til:	2017.12.21
(73)	Innehaver:	Dispar Design Harald Brustad , Snippen 19 A, 0566, OSLO, NO		

(11)	Reg.nr:	081357	Fornyhet til:	2018.06.10
(73)	Innehaver:	Koninklijke Philips Electronics NV , Groenewoudseweg 1, 5621BA, EINDHOVEN, NL		
(74)	Fullmektig:	Hynell AS , Parkveien 53 B, 0256, OSLO, NO		

(11)	Reg.nr:	081357	Fornyhet til:	2018.06.10
(73)	Innehaver:	Koninklijke Philips Electronics NV , Groenewoudseweg 1, 5621BA, EINDHOVEN, NL		
(74)	Fullmektig:	Hynell AS , Parkveien 53 B, 0256, OSLO, NO		

(11)	Reg.nr:	081359	Fornyhet til:	2018.06.16
(73)	Innehaver:	Bosch Pouch Systems AG , Rheinstrasse 36, 8212, NEUHAUSEN, CH		
(74)	Fullmektig:	Curo AS , Industriveien 53, 7080, HEIMDAL, NO		

(11)	Reg.nr:	081372	Fornyhet til:	2018.06.11
(73)	Innehaver:	Koninklijke Philips Electronics NV , Groenewoudseweg 1, 5621BA, EINDHOVEN, NL		
(74)	Fullmektig:	Hynell AS , Parkveien 53 B, 0256, OSLO, NO		

(11)	Reg.nr:	081388	Fornyhet til:	2018.07.09
(73)	Innehaver:	Villeroy & Boch AG , Saaruferstrasse 14-18, 66693, METTLACH, DE		
(74)	Fullmektig:	Curo AS , Industriveien 53, 7080, HEIMDAL, NO		

(11)	Reg.nr:	081475	Fornyhet til:	2018.06.11
(73)	Innehaver:	Koninklijke Philips Electronics NV , Groenewoudseweg 1, 5621BA, EINDHOVEN, NL		
(74)	Fullmektig:	Hynell AS , Parkveien 53 B, 0256, OSLO, NO		

(11)	Reg.nr:	081534	Fornyhet til:	2018.07.03
(73)	Innehaver:	Sinituote OY , Erskylän kartano 50, 05820, HYVINGE, FI		
(74)	Fullmektig:	Oslo Patentkontor AS , Postboks 7007 Majorstua , 0306, OSLO, NO		

(11) **Reg.nr:** 081607 **Fornyset til:** 2018.06.13
(73) **Innehaver:** Hensley Industries Inc , P. O. Box 29779, TX75229, DALLAS, US
(74) **Fullmektig:** Tandbergs Patentkontor AS , Postboks 1570 Vika, 0118, OSLO, NO

(11) **Reg.nr:** 081649 **Fornyset til:** 2018.09.25
(73) **Innehaver:** Ostnor AB , Box 480, 79227, MORA, SE
(74) **Fullmektig:** Acapo AS , Postboks 1880 Nordnes, 5817, BERGEN, NO

(11) **Reg.nr:** 081654 **Fornyset til:** 2018.06.04
(73) **Innehaver:** Flex Trim A/S , Lyngvænget 6, Glyngøre, 7870, ROSLEV, DK
(74) **Fullmektig:** Oslo Patentkontor AS , Postboks 7007 Majorstua , 0306, OSLO, NO

(11) **Reg.nr:** 081677 **Fornyset til:** 2018.09.04
(73) **Innehaver:** Øglænd System AS , Postboks 133, 4358, KLEPPE, NO
(74) **Fullmektig:** Håmsø Patentbyrå ANS , Postboks 171, 4302, SANDNES, NO
