

Norsk

design tidende

www.patentstyret.no

Norsk designtidende er en publikasjon som inneholder kunngjøringer innenfor designområdet

BESØKSADRESSE

- ▶ Sandakerveien 64

POSTADRESSE

- ▶ Postboks 8160 Dep.
0033 Oslo

E-POST

- ▶ mail@patentstyret.no

TELEFON

- ▶ 22 38 73 00

TELEFAKS

- ▶ 22 38 73 01

INFOSENTERETS TELEFONTID

- ▶ kl. 09.00 - 15.00
Telefon (+47) 22 38 73 33
Telefaks (+47) 22 38 73 31

Innholdsfortegnelse:

Registrerte design	3
Internasjonale designregistreringer	26
Overdragelser	66
Endringer i fullmaktsforhold	67
Fornyelse av registreringer	68
Rettelse.....	70

INID-koder

I kunngjøringene er de enkelte data forsynt med koder overensstemmende med INID-kodesystemet

(INID= Internationally agreed Numbers for the Identification of Data).

- (11) Registreringsnummer
- (15) Registreringsdato
- (18) Dato som registreringen gjelder til
- (21) Søknadsnummer
- (22) Inngivelsesdato
- (24) Løpedag
- (30) Prioritetsopplysninger
- (43) Allment tilgjengelig dato
- (51) Klasse
- (54) Produkt
- (55) Avbildning(er)
- (72) Designer
- (73) Innehaver
- (74) Fullmektig

Registrerte design

I henhold til designloven § 18 første ledd i.f. kunngjøres i dag følgende registrerte design.

Det kan fremsettes krav om at designregistreringen helt eller delvis skal oppheves, jf. designloven §§ 25 flg. og designforskriften §§ 26 flg.

Designregistreringen gjelder for den eller de periodene på fem år som søknaden er innlevert for, regnet fra søknadsdagen. Registreringen kan fornyes, jf. designloven §§ 23 og 24. Maksimal beskyttelsestid er 25 år. For reservedeler, se unntaket i designloven § 23 annet ledd.

- | | | |
|------|--------------------------|--|
| (11) | Reg.nr.: | 083851 |
| (21) | Søkn.nr.: | 20121027 |
| (22) | Inngitt: | 2012.11.26 |
| (24) | Løpedag: | 2012.11.26 |
| (43) | Allm. tilgj.: | 2013.03.05 |
| (15) | Registrert: | 2013.03.05 |
| (45) | Kunngjort: | 2013.04.02 |
| (18) | Reg. gjelder til: | 2017.11.26 |
| (74) | Fullmektig: | Zacco Norway AS, Postboks 2003 Vika, 0125 OSLO, Norge |
| (73) | Innehaver: | African Oxygen Ltd, Afrox House, 23 Webber Street Selby, ZA-2001 JOHANNESBURG, GAUTENG, Sør-Afrika |
| (50) | Anmerkninger: | Registreringen gjelder samregistrering. |

Design 1

- | | | |
|------|----------------------------|---|
| (54) | Produkt: | Gasstrykkregulator |
| (51) | Klasse: | 23-01 |
| (72) | Designert: | Roberto Maria Marcello Dionisio, 4 Hillside Manor, Julius Wernher Road BRUMA, Sør-Afrika (ZA)
Radoslav Jovanovic, 6 Harris Avenue BRYANSTON, Sør-Afrika (ZA) |
| (55) | Designavbildninger: | |

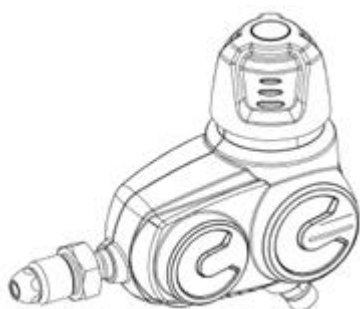

1.1

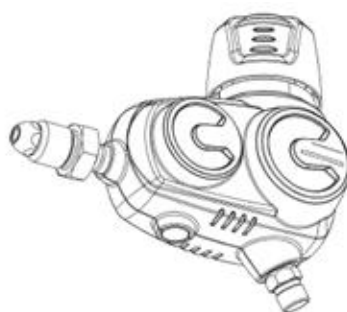

1.2



1.3

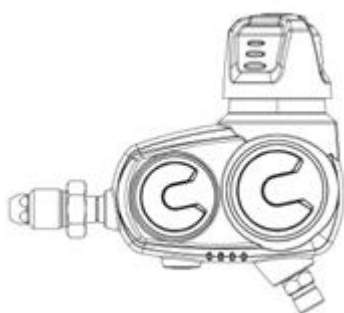

1.4

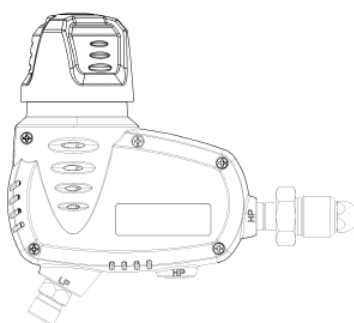

1.5

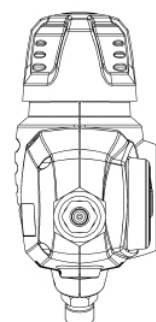

1.6

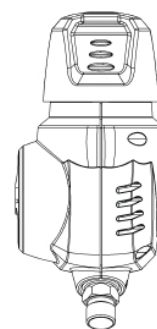

1.7

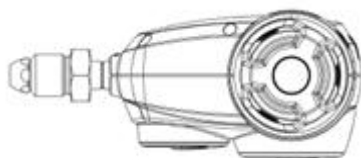

1.8



1.9

Design 2

- (54) **Produkt:** Gasstrykkregulator
(51) **Klasse:** 23-01
(72) **Designer:** Roberto Maria Marcello Dionisio, 4 Hillside Manor, Julius Wernher Road BRUMA, Sør-Afrika (ZA)
Radoslav Jovanovic, 6 Harris Avenue BRYANSTON, Sør-Afrika (ZA)
(55) **Designavbildninger:**

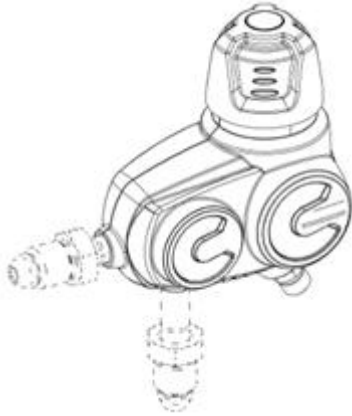

2.1

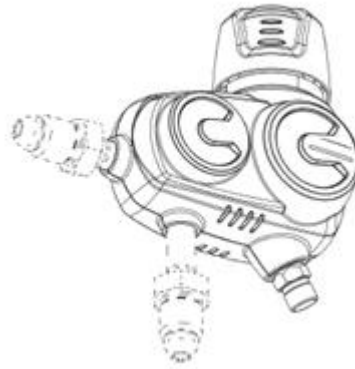

2.2

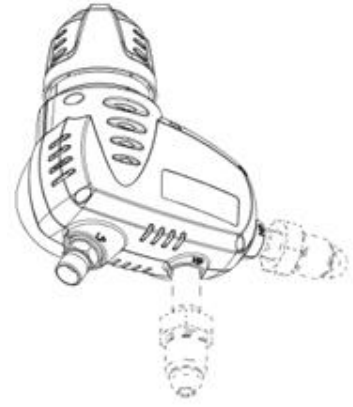

2.3

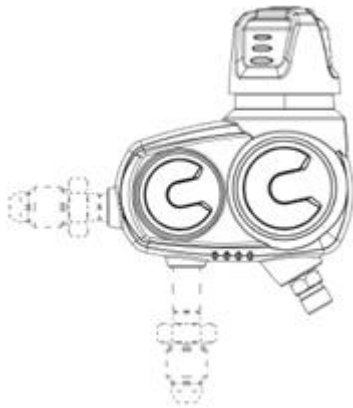

2.4

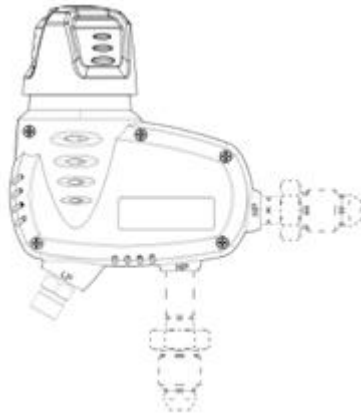

2.5

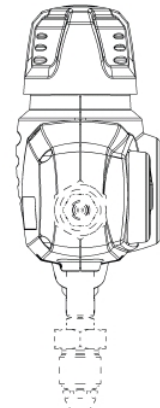

2.6

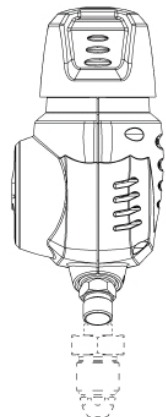

2.7

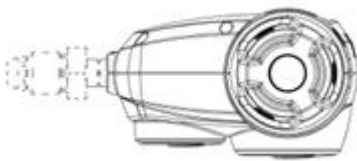

2.8

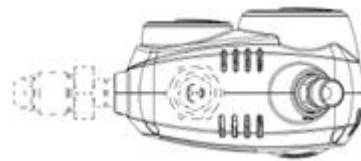

2.9

Design 3

- (54) **Produkt:** Gasstrykkregulator
- (51) **Klasse:** 23-01
- (72) **Designer:** Roberto Maria Marcello Dionisio, 4 Hillside Manor, Julius Wernher Road BRUMA, Sør-Afrika (ZA)
Radoslav Jovanovic, 6 Harris Avenue BRYANSTON, Sør-Afrika (ZA)
- (55) **Designavbildninger:**

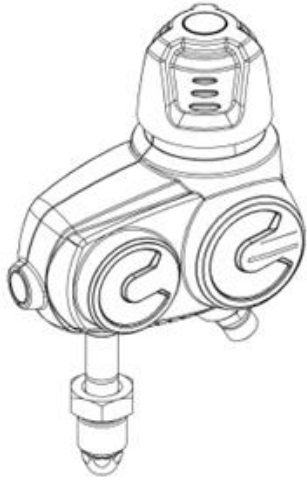

3.1

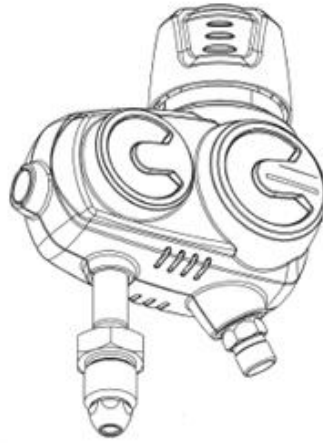

3.2



3.3

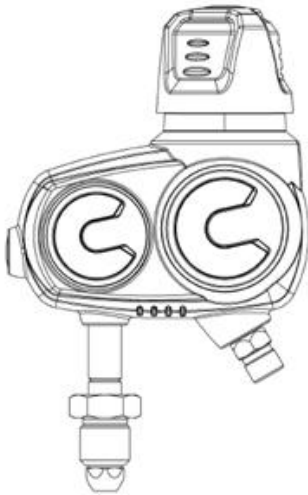

3.4

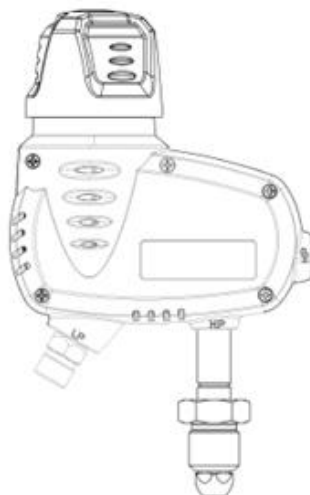

3.5

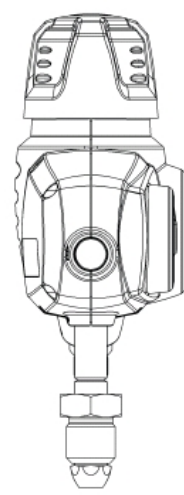

3.6

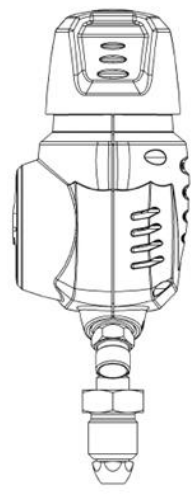

3.7

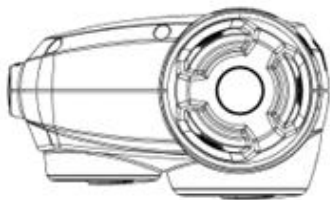

3.8

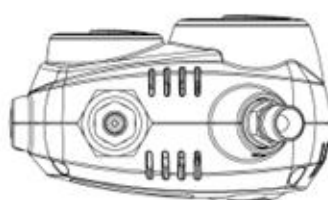

3.9

- (11) **Reg.nr.:** 083852
(21) **Søkn.nr.:** 20120799
(22) **Inngitt:** 2012.09.26
(24) **Løpedag:** 2012.09.26
(43) **Allm. tilgj.:** 2012.09.26
(15) **Registrert:** 2013.03.06
(45) **Kunngjort:** 2013.04.02
(18) **Reg. gjelder til:** 2017.09.26
(73) **Innehaver:** Trine Melinda Vollan, Valhallvegen 12 B, 2409 ELVERUM, Norge
(50) **Anmerkninger:** Registreringen gjelder samregistrering.

Design 1

- (54) **Produkt:** Ridebukse
(51) **Klasse:** 02-02
(72) **Designer:** Trine Melinda Vollan, Valhallvegen 12 B, 2409 ELVERUM
(50) **Anmerkning:** Fig. 1.3 og 1.4 viser detaljutsnitt.
(55) **Designavbildninger:**



1.1



1.2



1.3



1.4

Design 2

- (54) **Produkt:** Ridebukse
(51) **Klasse:** 02-02
(72) **Designer:** Trine Melinda Vollan, Valhallvegen 12 B, 2409 ELVERUM
(50) **Anmerkning:** Fig. 2.3 viser et detaljutsnitt.
(55) **Designavbildninger:**



2.1



2.2



2.3

(11)	Reg.nr.:	083853
(21)	Søkn.nr.:	20130020
(22)	Inngitt:	2013.01.16
(24)	Løpedag:	2012.09.26
(43)	Allm. tilgj.:	2012.09.26
(15)	Registrert:	2013.03.06
(45)	Kunngjort:	2013.04.02
(18)	Reg. gjelder til:	2017.09.26
(73)	Innehaver:	Trine Melinda Vollan, Valhallvegen 12 B, 2409 ELVERUM, Norge
(50)	Anmerkninger:	Designen er i farger.

Design 1

(54)	Produkt:	Logo
(51)	Klasse:	32-00
(72)	Designer:	Trine Melinda Vollan, Valhallvegen 12 B, 2409 ELVERUM
(50)	Anmerkning:	Designen er i farger.
(55)	Designavbildninger:	



1.1

(11)	Reg.nr.:	083854
(21)	Søkn.nr.:	20120709
(22)	Inngitt:	2012.08.17
(24)	Løpedag:	2012.08.17
(43)	Allm. tilgj.:	2013.02.17
(15)	Registrert:	2013.03.07
(45)	Kunngjort:	2013.04.02
(18)	Reg. gjelder til:	2017.08.17
(73)	Innehaver:	Bjørn Edwardsen, Fagerlia 9, 0667 OSLO, Norge
(50)	Anmerkninger:	Registreringen gjelder samregistrering.

Design 1

(54)	Produkt:	Kombinert lommebok og kortholder med festeanordning for mobiltelefoner
(51)	Klasse:	03-01
(72)	Designer:	Jane Pernille Landa Hansen, Tollef Gravs vei 159, 1359 JAR
(55)	Designavbildninger:	

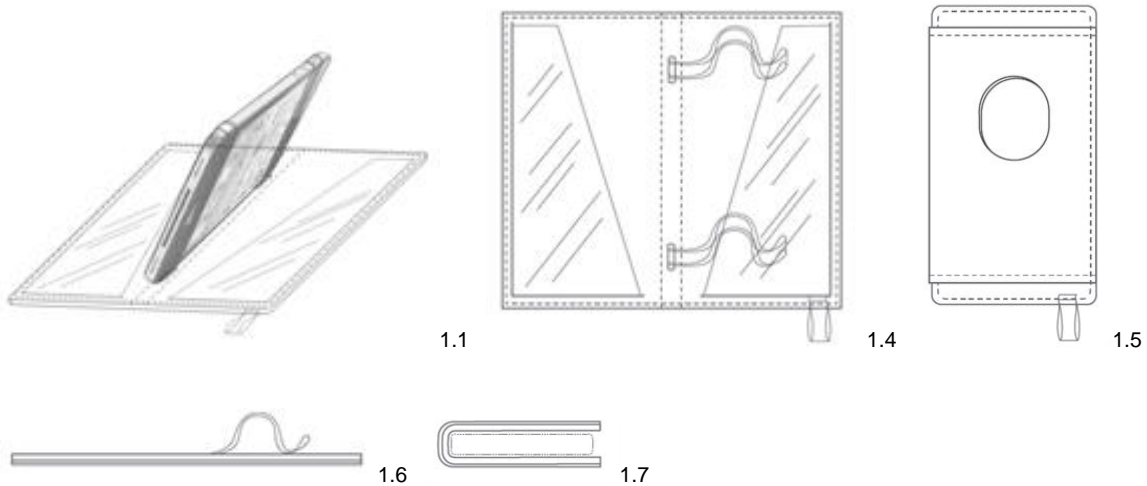
**Design 2**

(54)	Produkt:	Del av lommebok/kortholder/omslag for mobiltelefon instikk fra begge kortsidene og med senteralt plassert fingerhull
(51)	Klasse:	03-01
(72)	Designer:	Jane Pernille Landa Hansen, Tollef Gravs vei 159, 1359 JAR
(50)	Anmerkning:	Figurene 2.7 og 2.8 er tversnitt.
(55)	Designavbildninger:	

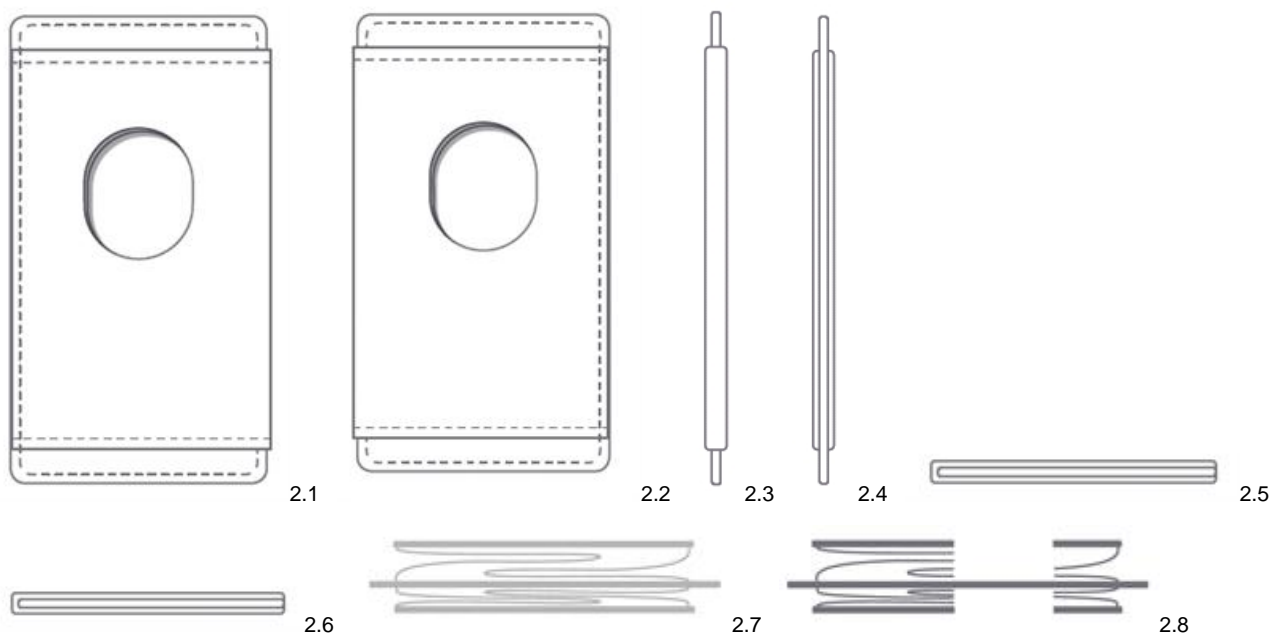

Design 3

(54)	Produkt:	Festeanordning for mobiltelefon
(51)	Klasse:	03-01
(72)	Designer:	Jane Pernille Landa Hansen, Tollef Gravs vei 159, 1359 JAR
(55)	Designavbildninger:	



3.1

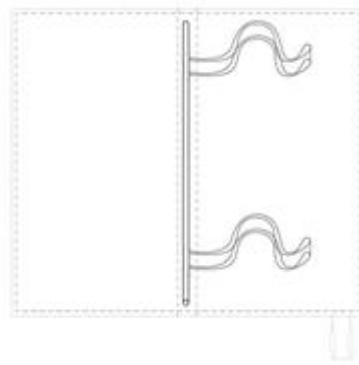

3.2



3.3

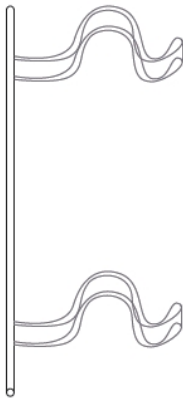

3.4



3.5

(11)	Reg.nr.:	083855
(21)	Søkn.nr.:	20120941
(22)	Inngitt:	2012.10.25
(24)	Løpedag:	2012.10.25
(43)	Allm. tilgj.:	2012.10.25
(15)	Registrert:	2013.03.08
(45)	Kunngjort:	2013.04.02
(18)	Reg. gjelder til:	2017.10.25
(74)	Fullmektig:	GRY WIGRE, JENS BJELKES GATE 41 B, 0578 OSLO, Norge
(73)	Innehaber:	USY AS, Drammensveien 130 c1, 0277 OSLO, Norge

Design 1

(54)	Produkt:	Brillhenger
(51)	Klasse:	03-01
(72)	Designer:	Johan Verde, Jonsrudveien 14, 0274 OSLO
(55)	Designavbildninger:	



1.1

Design 2

(54)	Produkt:	Del til brillehenger
(51)	Klasse:	03-01
(72)	Designer:	Johan Verde, Jonsrudveien 14, 0274 OSLO
(55)	Designavbildninger:	



2.1

(11)	Reg.nr.:	083856
(21)	Søkn.nr.:	20121147
(22)	Inngitt:	2012.12.21
(24)	Løpedag:	2012.12.21
(43)	Allm. tilgj.:	2012.12.21
(15)	Registrert:	2013.03.08
(45)	Kunngjort:	2013.04.02
(18)	Reg. gjelder til:	2017.12.21
(74)	Fullmektig:	Tandbergs Patentkontor AS, Postboks 1570 Vika, 0118 OSLO, Norge
(73)	Innehaver:	JensenPlus Contracts ApS, Frederiksdalvej 8, DK-8940 RANDERS SV, Danmark

Design 1

(54)	Produkt:	Skrivebord
(51)	Klasse:	06-03
(72)	Designert:	Jeanette Omann, v/JensenPlus Contracts ApS, Frederiksdalvej 8, 8940 RANDERS SV, Danmark (DK)
(74)	Fullmektig:	Mikkel Bahr, v/Friis & Moltke A/S, Åboulevarden 1, 8000 AARHUS C, Danmark (DK)
(50)	Anmerkning:	Fig. 1.2 viser et detaljutsnitt.
(55)	Designavbildninger:	



- (11) **Reg.nr.:** 083857
 (21) **Søkn.nr.:** 20130121
 (22) **Inngitt:** 2013.01.31
 (24) **Løpedag:** 2013.01.31
 (43) **Allm. tilgj.:** 2013.03.11
 (15) **Registrert:** 2013.03.11
 (45) **Kunngjort:** 2013.04.02
 (18) **Reg. gjelder til:** 2018.01.31
 (74) **Fullmektig:** Zacco Norway AS, Postboks 2003 Vika, 0125 OSLO, Norge
 (73) **Innehaver:** Vestre AS, Postboks 49, Tåsen, 0801 OSLO, Norge
 (50) **Anmerkninger:** Registreringen gjelder samregistrering.

Design 1

- (54) **Produkt:** Avfallsbeholder
 (51) **Klasse:** 09-09
 (72) **Designer:** Tore Borgersen, Siriusveien 20B, 0492 OSLO
 Michael Olofsson, Rødbergveien 27, 0591 OSLO
 Espen Voll, Sonsgate 5c, 0654 OSLO
- (55) **Designavbildninger:**

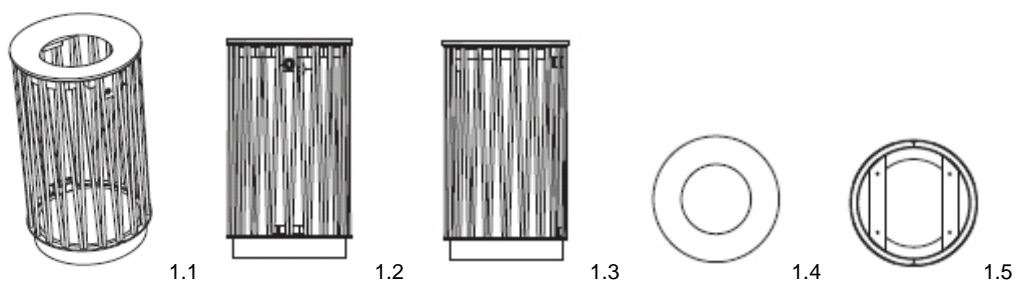
**Design 2**

- (54) **Produkt:** Avfallsbeholder
 (51) **Klasse:** 09-09
 (72) **Designer:** Tore Borgersen, Siriusveien 20B, 0492 OSLO
 Michael Olofsson, Rødbergveien 27, 0591 OSLO
 Espen Voll, Sonsgate 5c, 0654 OSLO
- (55) **Designavbildninger:**

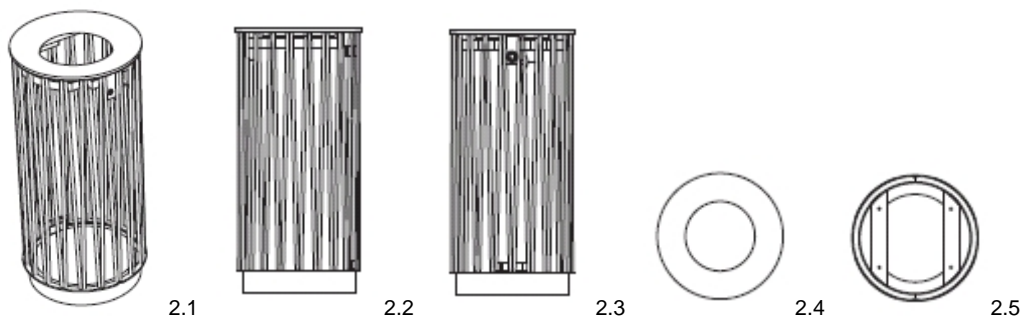

Design 3

- (54) **Produkt:** Avfallsbeholder
(51) **Klasse:** 09-09
(72) **Designer:** Tore Borgersen, Siriusveien 20B, 0492 OSLO
Michael Olofsson, Rødbergveien 27, 0591 OSLO
Espen Voll, Sonsgate 5c, 0654 OSLO

(55) **Designavbildninger:**

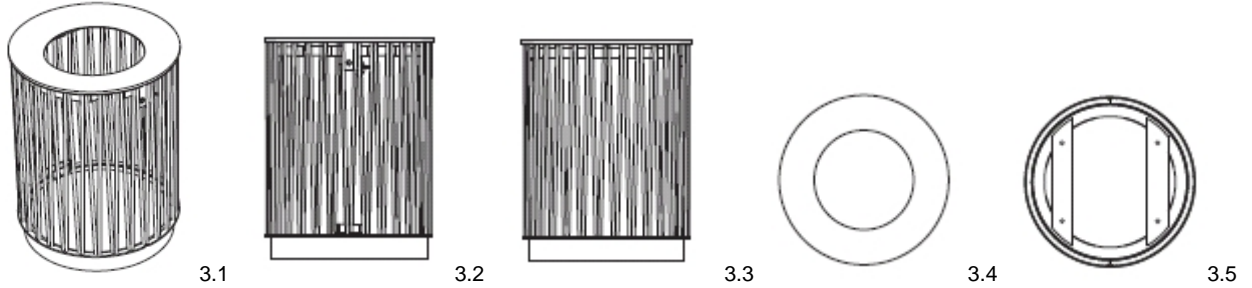
**Design 4**

- (54) **Produkt:** Avfallsbeholder
(51) **Klasse:** 09-09
(72) **Designer:** Tore Borgersen, Siriusveien 20B, 0492 OSLO
Michael Olofsson, Rødbergveien 27, 0591 OSLO
Espen Voll, Sonsgate 5c, 0654 OSLO

(55) **Designavbildninger:**

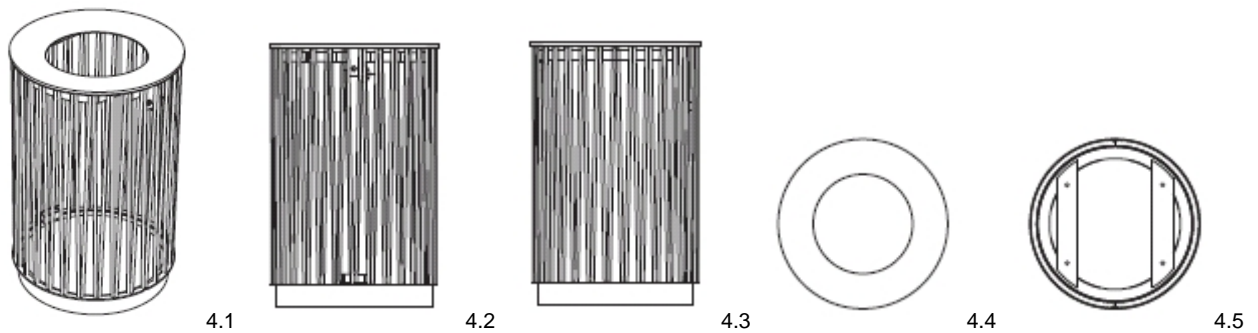

- (11) **Reg.nr.:** 083858
(21) **Søkn.nr.:** 20130122
(22) **Inngitt:** 2013.01.31
(24) **Løpedag:** 2013.01.31
(43) **Allm. tilgj.:** 2013.03.11
(15) **Registrert:** 2013.03.11
(45) **Kunngjort:** 2013.04.02
(18) **Reg. gjelder til:** 2018.01.31
(74) **Fullmektig:** Zacco Norway AS, Postboks 2003 Vika, 0125 OSLO, Norge
(73) **Innehaber:** Vestre AS, Postboks 49, Tåsen, 0801 OSLO, Norge

Design 1

- (54) **Produkt:** Benk
(51) **Klasse:** 06-01
(72) **Designner:** Michael Olofsson, Rødbergveien 27, 0591 OSLO
Espen Voll, Sonsgate 5c, 0654 OSLO
Tore Borgersen, Siriusveien 20 B, 0492 OSLO

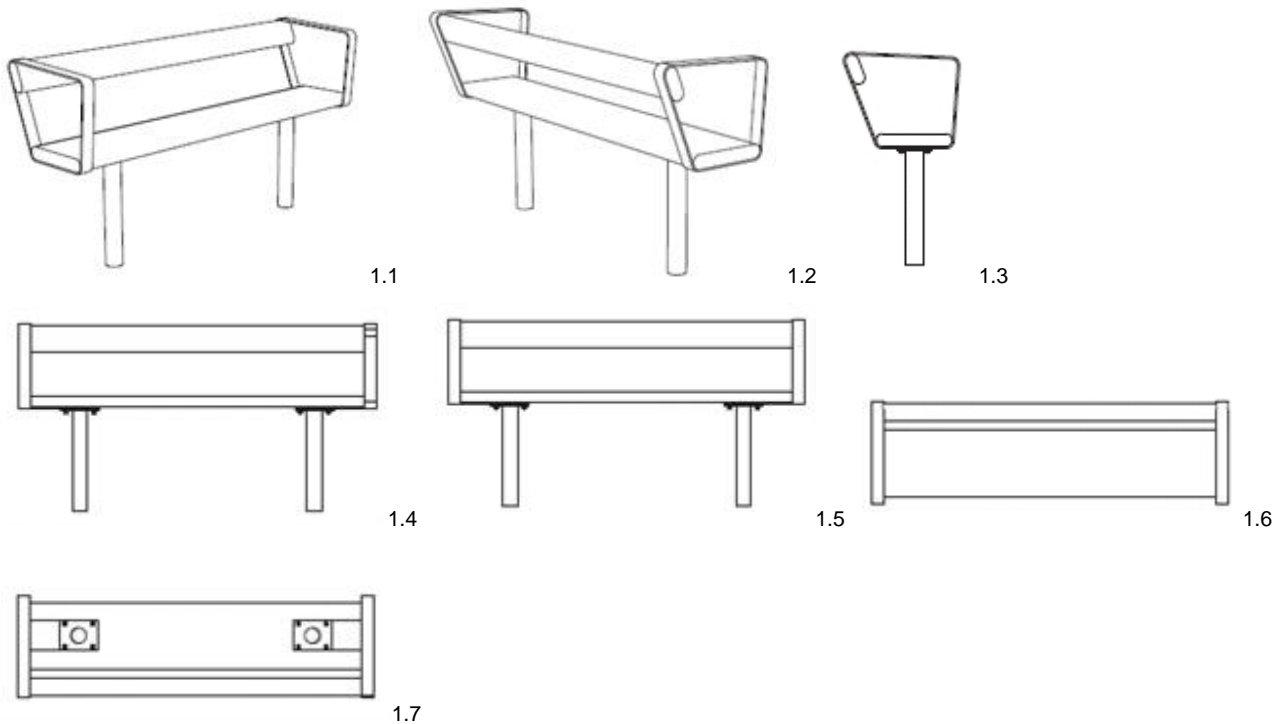
(55) Designavbildninger:

(11)	Reg.nr.:	083859
(21)	Søkn.nr.:	20130114
(22)	Inngitt:	2013.01.27
(24)	Løpedag:	2013.01.27
(43)	Allm. tilgj.:	2013.01.27
(15)	Registrert:	2013.03.11
(45)	Kunngjort:	2013.04.02
(18)	Reg. gjelder til:	2018.01.27
(73)	Innehaver:	CHRISTOPHER NORDAHL KONINGS, TOFTES GATE 47 B, 0552 OSLO, Norge
(50)	Anmerkninger:	Designen er i farger.

Design 1

(54)	Produkt:	Armbåndsur
(51)	Klasse:	10-02
(72)	Designer:	CHRISTOPHER NORDAHL KONINGS, TOFTES GATE 47 B, 0552 OSLO
(50)	Anmerkning:	Designen er i farger.
(55)	Designavbildninger:	



1.5

(11)	Reg.nr.:	083860
(21)	Søkn.nr.:	20121148
(22)	Inngitt:	2012.12.21
(24)	Løpedag:	2012.12.21
(43)	Allm. tilgj.:	2013.03.13
(15)	Registrert:	2013.03.13
(45)	Kunngjort:	2013.04.02
(18)	Reg. gjelder til:	2017.12.21
(74)	Fullmektig:	Norsk Patentbyrå AS, Postboks 1204 Vika, 0110 OSLO, Norge
(73)	Innehaver:	MARKEVEIEN 12 AS, Postboks 64, Bønes, 5849 BERGEN, Norge

Design 1

(54)	Produkt:	Krydderglass (emballasje)
(51)	Klasse:	09-01
(72)	Designer:	MARKEVEIEN 12 AS, Postboks 64, Bønes, 5849 BERGEN
(55)	Designavbildninger:	



1.1

(11)	Reg.nr.:	083861
(21)	Søkn.nr.:	20120722
(22)	Inngitt:	2012.08.28
(24)	Løpedag:	2012.08.28
(43)	Allm. tilgj.:	2013.02.28
(15)	Registrert:	2013.03.13
(45)	Kunngjort:	2013.04.02
(18)	Reg. gjelder til:	2017.08.28
(74)	Fullmektig:	Fluges patent as, Postboks 27, 1629 GAMLE FREDRIKSTAD, Norge
(73)	Innehaver:	Seema AS, Storgata 32, 0184 OSLO, Norge
(50)	Anmerkninger:	Designen er i farger.

Design 1

(54)	Produkt:	Grafisk symbol
(51)	Klasse:	32-00
(72)	Designer:	Arthur Myhre Scott, Akersbakken 15, 0172 OSLO
(50)	Anmerkning:	Designen er i farger.
(55)	Designavbildninger:	



1.1

(11)	Reg.nr.:	083862
(21)	Søkn.nr.:	20121064
(22)	Inngitt:	2012.12.14
(24)	Løpedag:	2012.12.14
(43)	Allm. tilgj.:	2012.12.14
(15)	Registrert:	2013.03.13
(45)	Kunngjort:	2013.04.02
(18)	Reg. gjelder til:	2017.12.14
(74)	Fullmektig:	Zacco Norway AS, Postboks 2003 Vika, 0125 OSLO, Norge
(73)	Innehaver:	Master Lock Company LLC, 137 W. Forest Hill Avenue PO Box 927, US-WI53154 OAK CREEK, USA
(50)	Anmerkninger:	Registreringen gjelder samregistrering.

Design 1

(54)	Produkt:	Festestropp
(51)	Klasse:	08-08
(72)	Designer:	Jason Qin, Room 1104, Jiari North Street #9 TIANHE DISTRICT, GUANGZHOU, Kina (CN)
(30)	Prioritet:	2012.06.15, US, 29/424,796
(55)	Designavbildninger:	

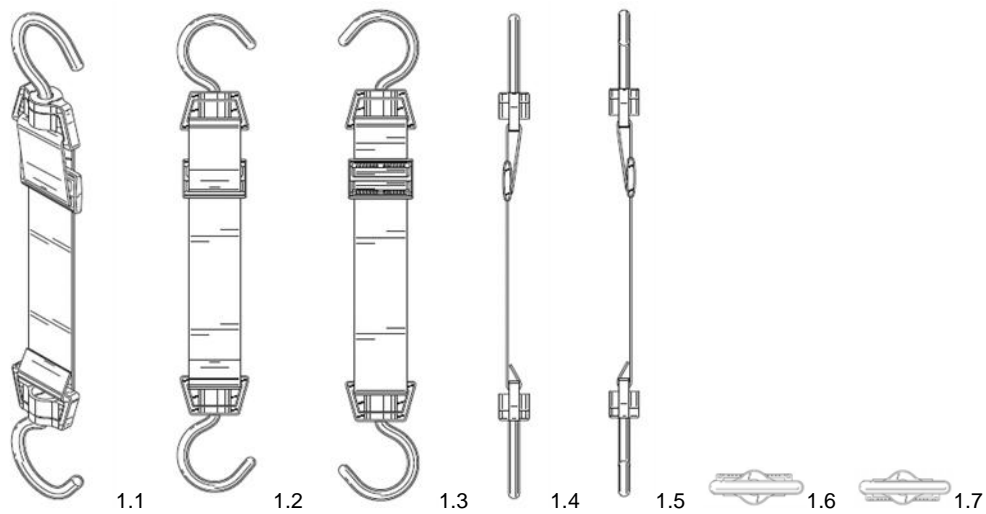
**Design 2**

(54)	Produkt:	Festestropp
(51)	Klasse:	08-08
(72)	Designer:	Jason Qin, Room 1104, Jiari North Street #9 TIANHE DISTRICT, GUANGZHOU, Kina (CN)
(30)	Prioritet:	2012.06.15, US, 29/424,796
(55)	Designavbildninger:	

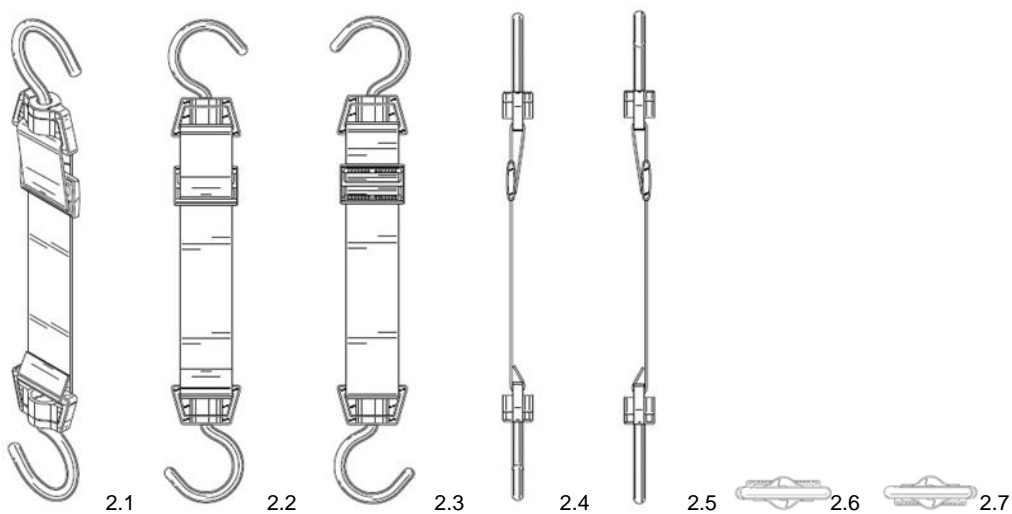

Design 3

(54) **Produkt:** Del av festestropp
 (51) **Klasse:** 08-08
 (72) **Designer:** Jason Qin, Room 1104, Jiari North Street #9 TIANHE DISTRICT, GUANGZHOU, Kina (CN)
 (30) **Prioritet:** 2012.06.15, US, 29/424,796
 (55) **Designavbildninger:**

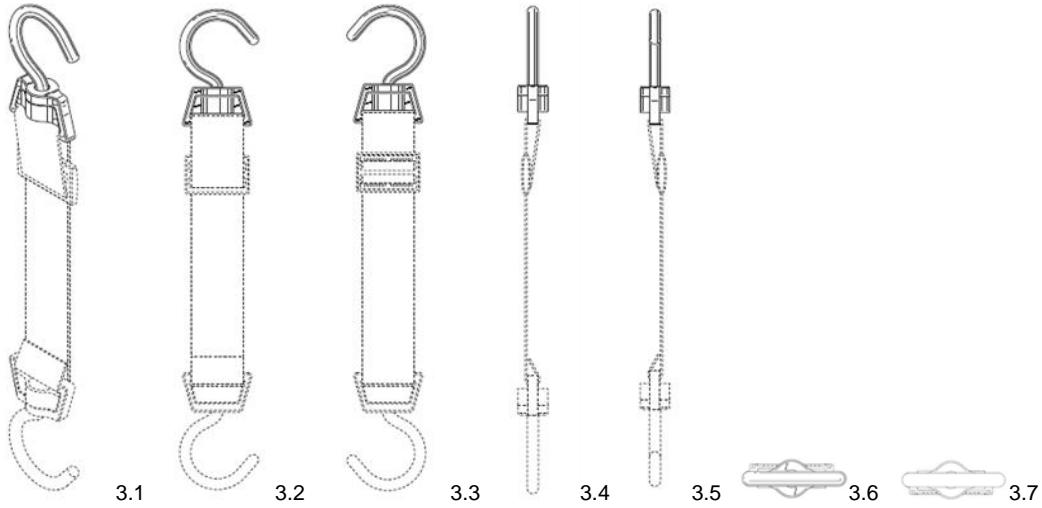

Design 4

(54) **Produkt:** Del av festestropp
 (51) **Klasse:** 08-08
 (72) **Designer:** Jason Qin, Room 1104, Jiari North Street #9 TIANHE DISTRICT, GUANGZHOU, Kina (CN)
 (30) **Prioritet:** 2012.06.15, US, 29/424,796
 (55) **Designavbildninger:**

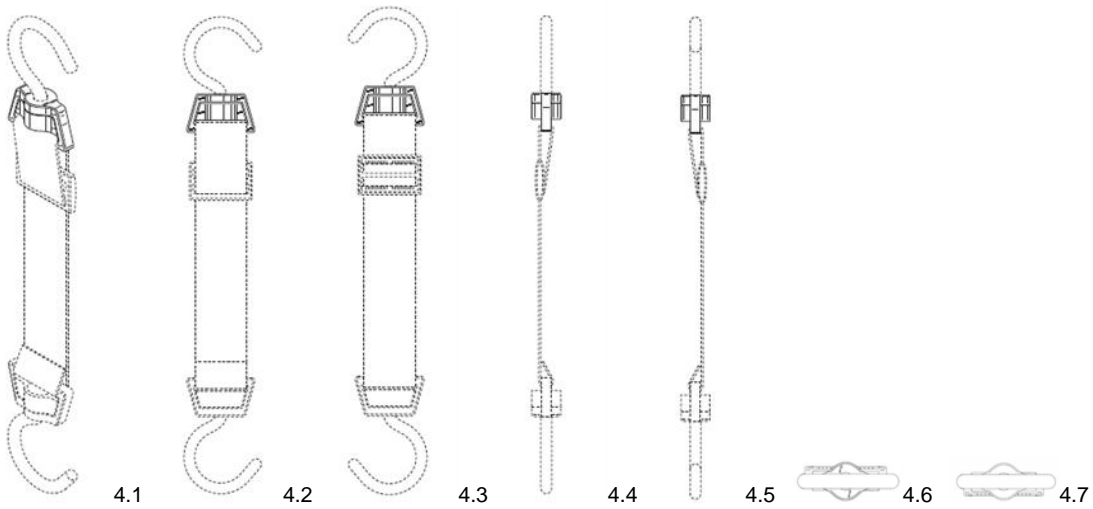

Design 5

(54) **Produkt:** Del av festestropp
 (51) **Klasse:** 08-08
 (72) **Designer:** Jason Qin, Room 1104, Jiari North Street #9 TIANHE DISTRICT, GUANGZHOU, Kina (CN)
 (30) **Prioritet:** 2012.06.15, US, 29/424,796
 (55) **Designavbildninger:**

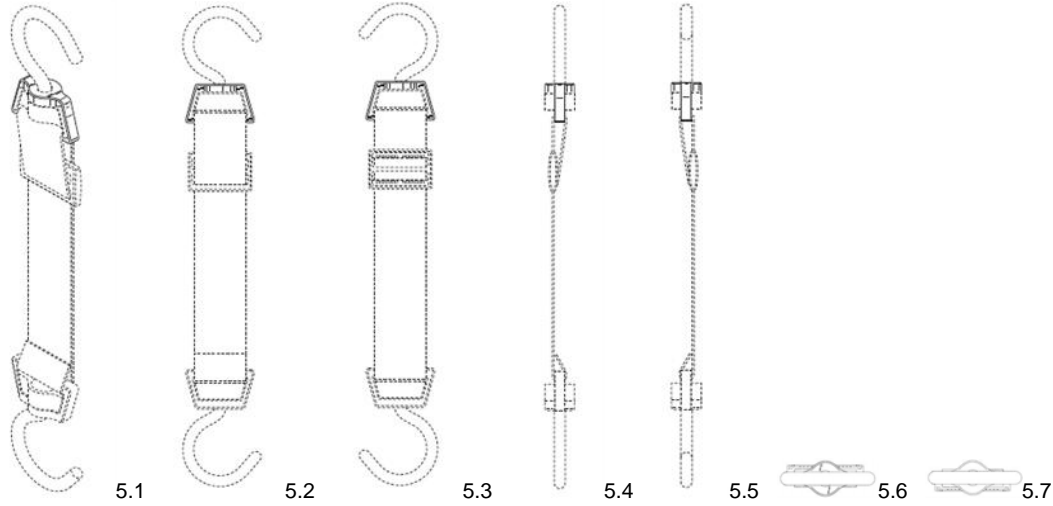

Design 6

(54) **Produkt:** Del av festestropp
 (51) **Klasse:** 08-08
 (72) **Designer:** Jason Qin, Room 1104, Jiari North Street #9 TIANHE DISTRICT, GUANGZHOU, Kina (CN)
 (30) **Prioritet:** 2012.06.15, US, 29/424,796
 (55) **Designavbildninger:**

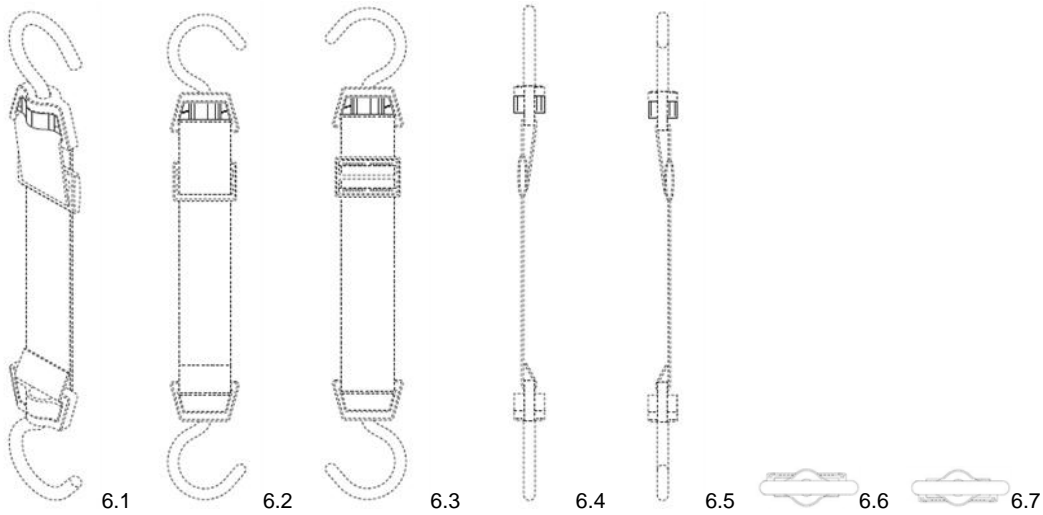

- (11) **Reg.nr.:** 083863
(21) **Søkn.nr.:** 20130113
(22) **Inngitt:** 2013.01.25
(24) **Løpedag:** 2013.01.25
(43) **Allm. tilgj.:** 2013.03.14
(15) **Registrert:** 2013.03.14
(45) **Kunngjort:** 2013.04.02
(18) **Reg. gjelder til:** 2018.01.25
(73) **Innehaver:** Milan Banjanin, Thurmannsgt 14 A, 0461 OSLO, Norge
(50) **Anmerkninger:** Registreringen gjelder samregistrering.

Design 1

- (54) **Produkt:** Bakevare/kjeks/konditorvare/sjokolade/konfekt
(51) **Klasse:** 01-01
(72) **Designer:** Milan Banjanin, Thurmannsgt 14 A, 0461 OSLO
(55) **Designavbildninger:**

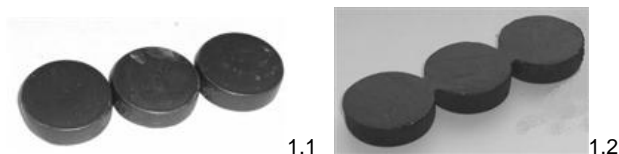

Design 2

- (54) **Produkt:** Bakevare/kjeks/konditorvare/sjokolade/konfekt
(51) **Klasse:** 01-01
(72) **Designer:** Milan Banjanin, Thurmannsgt 14 A, 0461 OSLO
(55) **Designavbildninger:**

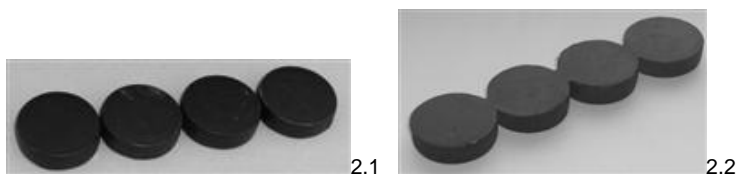

Design 3

- (54) **Produkt:** Bakevare/kjeks/konditorvare/sjokolade/konfekt
(51) **Klasse:** 01-01
(72) **Designer:** Milan Banjanin, Thurmannsgt 14 A, 0461 OSLO
(55) **Designavbildninger:**

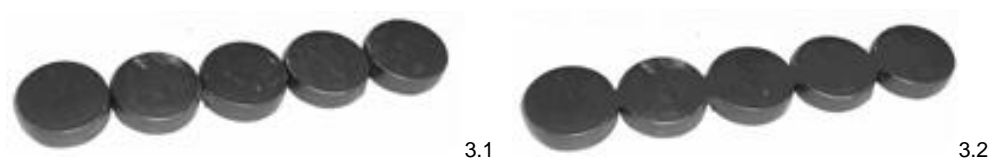

(11)	Reg.nr.:	083864
(21)	Søkn.nr.:	20120853
(22)	Inngitt:	2012.10.05
(24)	Løpedag:	2012.10.05
(43)	Allm. tilgj.:	2013.03.14
(15)	Registrert:	2013.03.14
(45)	Kunngjort:	2013.04.02
(18)	Reg. gjelder til:	2017.10.05
(73)	Innehaver:	Erlend Joakim Bergseng, Myrull vei 10 B, 8401 SORTLAND, Norge
(50)	Anmerkninger:	Registreringen gjelder samregistrering.

Design 1

(54)	Produkt:	Ornament
(51)	Klasse:	32-00
(72)	Designer:	Signe Kristensen, Nedreselnesvei 6, 8400 SORTLAND
(55)	Designavbildninger:	

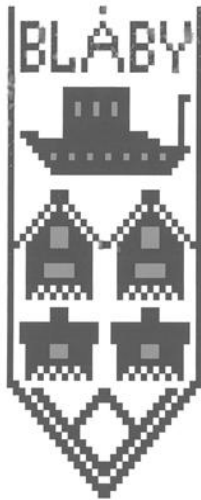

1.1

Design 2

(54)	Produkt:	Ornament
(51)	Klasse:	32-00
(72)	Designer:	Signe Kristensen, Nedreselnesvei 6, 8400 SORTLAND
(55)	Designavbildninger:	



2.1

Design 3

- (54) **Produkt:** Ornamment
(51) **Klasse:** 32-00
(72) **Designer:** Signe Kristensen, Nedreselnesvei 6, 8400 SORTLAND
(55) **Designavbildninger:**

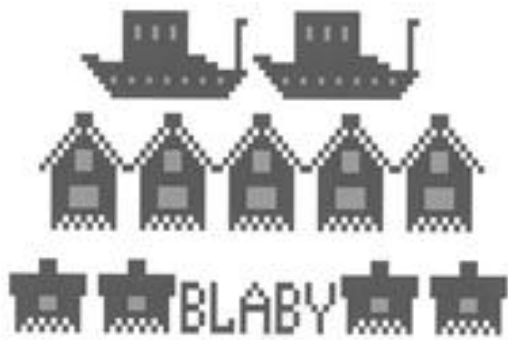

3.1

- (11) **Reg.nr.:** 083865
(21) **Søkn.nr.:** 20130127
(22) **Inngitt:** 2013.02.01
(24) **Løpedag:** 2013.02.01
(43) **Allm. tilgj.:** 2013.03.01
(15) **Registrert:** 2013.03.15
(45) **Kunngjort:** 2013.04.02
(18) **Reg. gjelder til:** 2018.02.01
(74) **Fullmektig:** Zacco Norway AS, Postboks 2003 Vika, 0125 OSLO, Norge
(73) **Innehaver:** Vestre AS, Postboks 49, Tåsen, 0801 OSLO, Norge

Design 1

- (54) **Produkt:** Barkrakk
(51) **Klasse:** 06-01
(72) **Designner:** Michael Olofsson, Rødbergveien 27, 0591 OSLO
Tore Borgersen, Siriusveien 20B, 0492 OSLO
Espen Voll, Sonsgate 5c, 0654 OSLO

- (55) **Designavbildninger:**

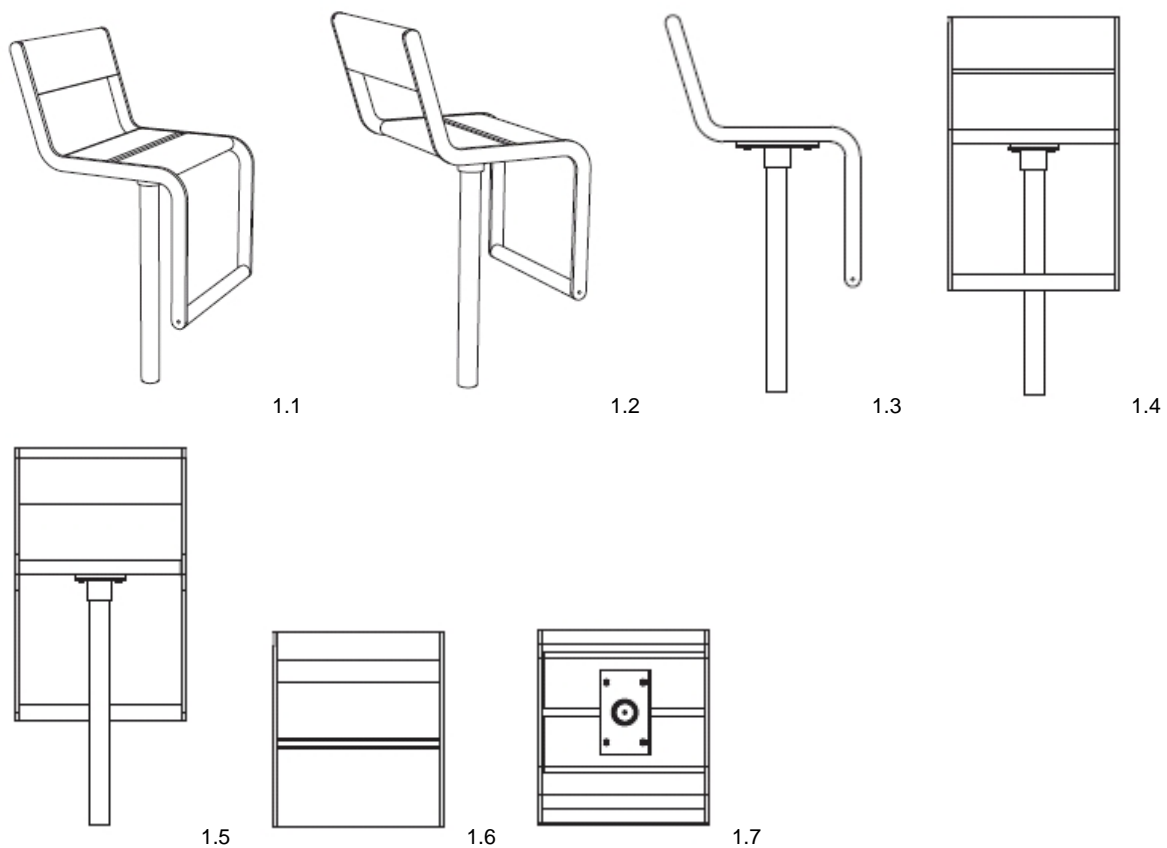

- (11) **Reg.nr.:** 083866
(21) **Søkn.nr.:** 20130128
(22) **Inngitt:** 2013.02.01
(24) **Løpedag:** 2013.02.01
(43) **Allm. tilgj.:** 2013.03.01
(15) **Registrert:** 2013.03.15
(45) **Kunngjort:** 2013.04.02
(18) **Reg. gjelder til:** 2018.02.01
(74) **Fullmektig:** Zacco Norway AS, Postboks 2003 Vika, 0125 OSLO, Norge
(73) **Innehaver:** Vestre AS, Postboks 49, Tåsen, 0801 OSLO, Norge
(50) **Anmerkninger:** Registreringen gjelder samregistrering.

Design 1

- (54) **Produkt:** Sykkelstativ
(51) **Klasse:** 08-10
(72) **Designner:** Michael Olofsson, Rødbergveien 27, 0591 OSLO
Tore Borgersen, Siriusveien 20B, 0492 OSLO
Espen Voll, Sonsgate 5c, 0654 OSLO
- (55) **Designavbildninger:**

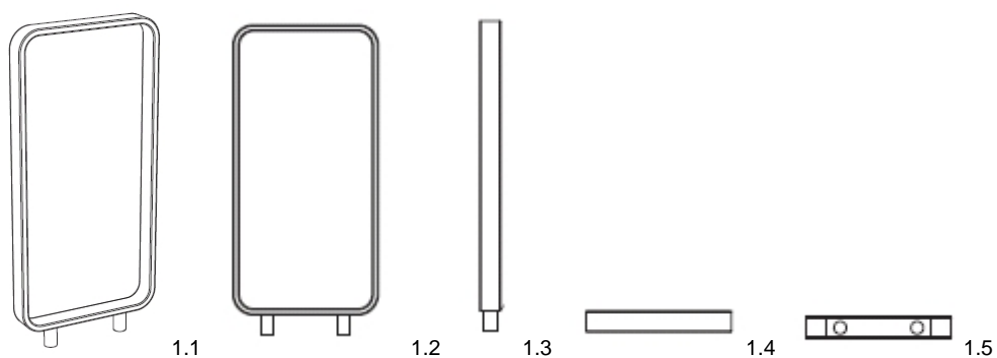

Design 2

- (54) **Produkt:** Sykkelstativ
(51) **Klasse:** 08-10
(72) **Designner:** Michael Olofsson, Rødbergveien 27, 0591 OSLO
Tore Borgersen, Siriusveien 20B, 0492 OSLO
Espen Voll, Sonsgate 5c, 0654 OSLO
- (55) **Designavbildninger:**

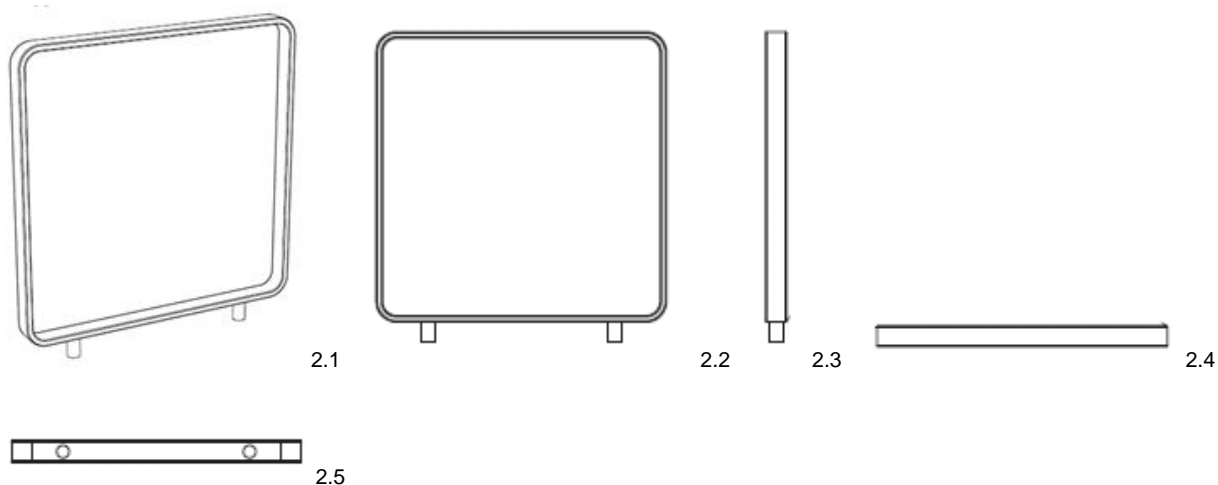

Internasjonale designregistreringer

I henhold til designloven § 57 fjerde ledd, kunngjøres i dag følgende internasjonale registreringer som har virkning i Norge.

Det kan fremsettes krav om at designregistreringen helt eller delvis skal oppheves, jf. designloven §§ 58 fjerde ledd og 25 flg. og designforskriften §§ 26 flg.

Virkingen av en internasjonal registrering gjelder for den eller de periodene på fem år som søknaden er innlevert for, regnet fra den dagen registreringen ved det Internasjonale byrået anses å ha skjedd. Registreringen kan fornyes etter bestemmelsene i Genèveavtalen, se dl § 58 tredje ledd. Maksimal beskyttelsestid er 25 år.

(11)	Reg.nr.:	DM/079018
(21)	Søkn.nr.:	20120914
(22)	Inngitt i WIPO:	2012.08.31
(15)	Registrert i WIPO:	2012.08.31
(24)	Løpedag:	2012.08.31
(43)	Allm. tilgj.:	2013.03.01
(15)	Besluttet gjeldende NO:	2013.03.04
(45)	Kunngjort NO:	2013.04.02
(18)	Reg. gjelder til:	2017.08.31
(73)	Innehaver:	Société des Produits Nestlé SA, CH-1800 VEVEY, Sveits
(50)	Anmerkninger:	Registreringen gjelder samregistrering.

Design 1

(54)	Produkt:	Beverage dispensers
(51)	Klasse:	07-02
(72)	Designer:	Pauline Bucher, Ruelle des Buissons 1, 2300 LA CHAUX-DE-FONDS, Sveits (CH)
(30)	Prioritet:	2012.04.05, CH, 138767
(55)	Designavbildninger:	



1.1



1.2



1.3



1.4



1.5



1.6



1.7

Design 2

- (54) **Produkt:** Beverage dispensers
- (51) **Klasse:** 07-02
- (72) **Designer:** Pauline Bucher, Ruelle des Buissons 1, 2300 LA CHAUX-DE-FONDS, Sveits (CH)
- (30) **Prioritet:** 2012.04.05, CH, 138767
- (55) **Designavbildninger:**



2.1



2.2



2.3



2.4



2.5



2.6



2.7

(11)	Reg.nr.:	DM/079040
(21)	Søkn.nr.:	20120906
(22)	Inngitt i WIPO:	2012.09.05
(15)	Registrert i WIPO:	2012.09.05
(24)	Løpedag:	2012.09.05
(43)	Allm. tilgj.:	2013.03.08
(15)	Besluttet gjeldende NO:	2013.03.14
(45)	Kunngjort NO:	2013.04.02
(18)	Reg. gjelder til:	2017.09.05
(73)	Innehaver:	Koninklijke Philips Electronics NV, Groenewoudseweg 1, NL-5621BA EINDHOVEN, Nederland

Design 1

(54)	Produkt:	Solid state lighting spot
(51)	Klasse:	26-04
(72)	Designer:	Lihua Lin, 602 room, No.39, Lane 245, Zhuanxing Road, Minhang District, 201108 SHANGHAI, Kina (CN) Gang Li, No.9, Lane 888, Tianlin Road, MinHang District, 200233 SHANGHAI, Kina (CN)
(30)	Prioritet:	2012.03.08, EM, 002005538
(55)	Designavbildninger:	



1.1

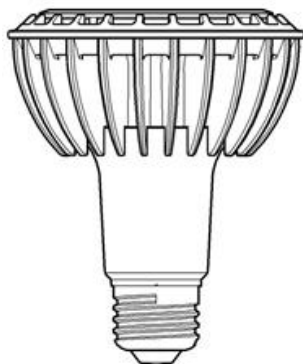

1.2

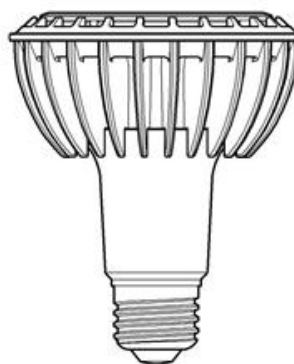

1.3

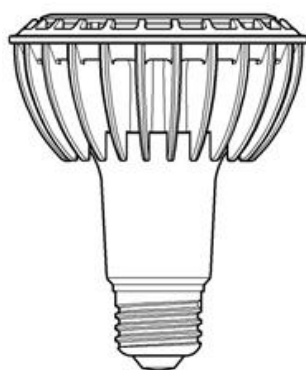

1.4

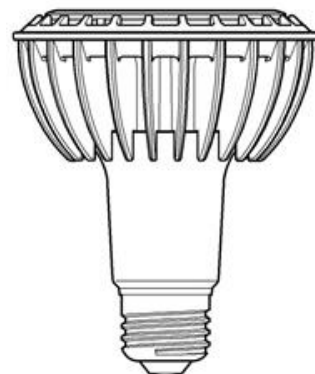

1.5



1.6

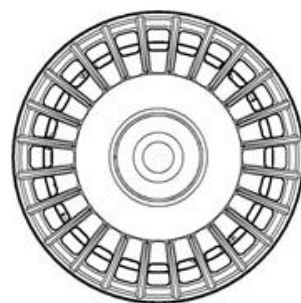

1.7

(11)	Reg.nr.:	DM/079041
(21)	Søkn.nr.:	20120905
(22)	Inngitt i WIPO:	2012.09.06
(15)	Registrert i WIPO:	2012.09.06
(24)	Løpedag:	2012.09.06
(43)	Allm. tilgj.:	2013.03.08
(15)	Besluttet gjeldende NO:	2013.03.14
(45)	Kunngjort NO:	2013.04.02
(18)	Reg. gjelder til:	2017.09.06
(73)	Innehaver:	Koninklijke Philips Electronics NV, Groenewoudseweg 1, NL-5621BA EINDHOVEN, Nederland
(50)	Anmerkninger:	Registreringen gjelder samregistrering.

Design 1

(54)	Produkt:	Led bulbs
(51)	Klasse:	26-04
(72)	Designer:	Peter Johannes Martinus Bukkems, Arenbroek 16, 5751RH DEURNE, Nederland (NL) Johan Petrus Maria Ansems, Smeelakkers 7, 5096CH HULSEL, Nederland (NL) Joris Hubertus Antonius Hagelaar, Jonker Rudolphof 1, 5673MB NUENEN, Nederland (NL) Simon Eme Kadijk, Herikbeek 8, 5501CG VELDHOVEN, Nederland (NL)
(30)	Prioritet:	2012.03.07, EM, 002004358
(55)	Designavbildninger:	

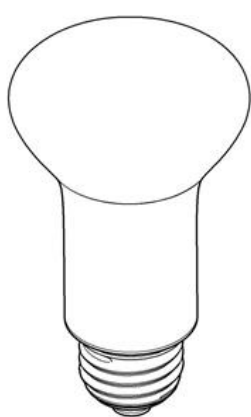

1.1

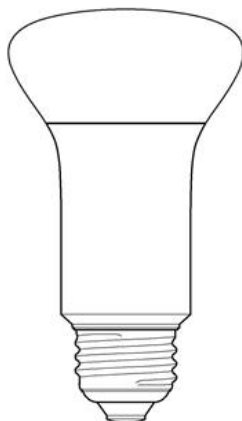

1.2

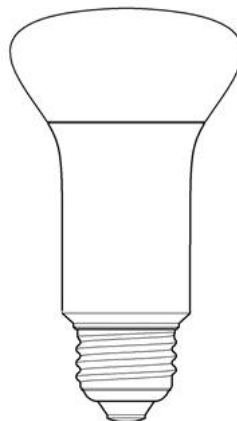

1.3

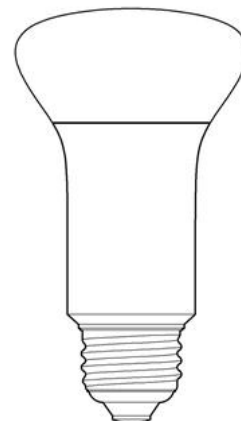

1.4

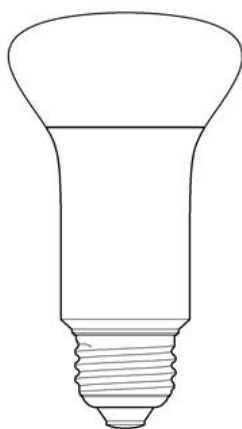

1.5

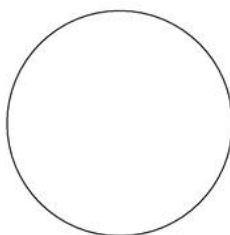

1.6

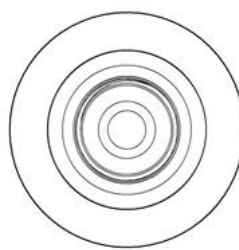

1.7

Design 2

- (54) **Produkt:** Led bulbs
(51) **Klasse:** 26-04
(72) **Designer:** Peter Johannes Martinus Bukkems, Arenbroek 16, 5751RH DEURNE, Nederland (NL)
Johan Petrus Maria Ansems, Smeelakkers 7, 5096CH HULSEL, Nederland (NL)
Joris Hubertus Antonius Hagelaar, Jonker Rudolphhof 1, 5673MB NUENEN, Nederland (NL)
Simon Eme Kadijk, Herikbeek 8, 5501CG VELDHOVEN, Nederland (NL)
(30) **Prioritet:** 2012.03.07, EM, 002004358
(55) **Designavbildninger:**

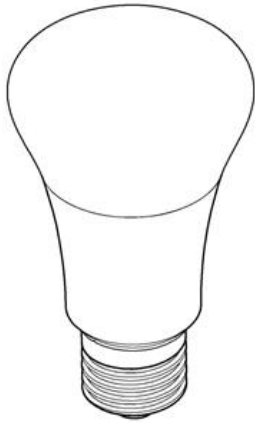

2.1

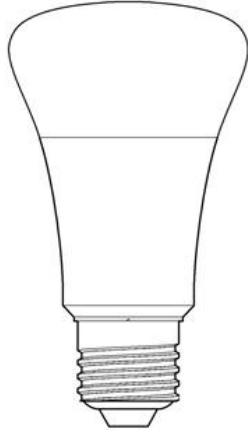

2.2

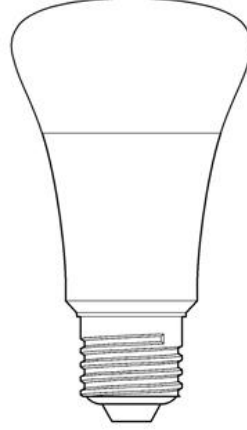

2.3

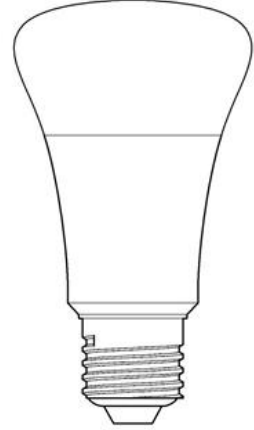

2.4

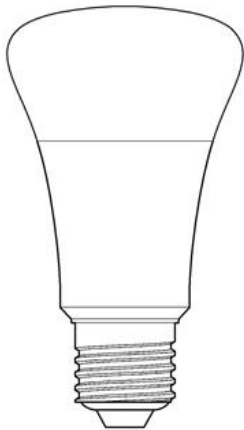

2.5

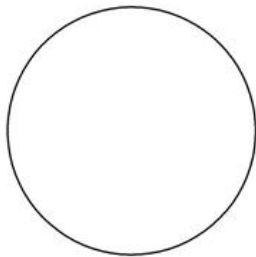

2.6

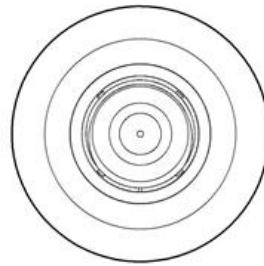

2.7

Design 3

- (54) **Produkt:** Led bulbs
(51) **Klasse:** 26-04
(72) **Designer:** Peter Johannes Martinus Bukkems, Arenbroek 16, 5751RH DEURNE, Nederland (NL)
Johan Petrus Maria Ansems, Smeelakkers 7, 5096CH HULSEL, Nederland (NL)
Joris Hubertus Antonius Hagelaar, Jonker Rudolphhof 1, 5673MB NUENEN, Nederland (NL)
Simon Eme Kadijk, Herikbeek 8, 5501CG VELDHOVEN, Nederland (NL)
(30) **Prioritet:** 2012.03.07, EM, 002004358
(55) **Designavbildninger:**

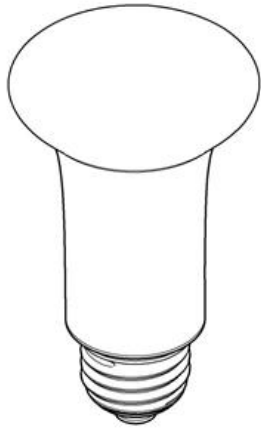

3.1

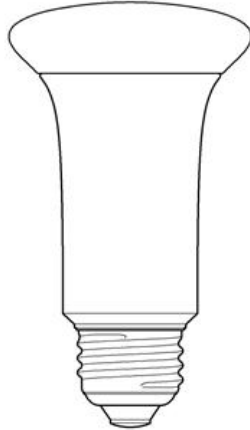

3.2

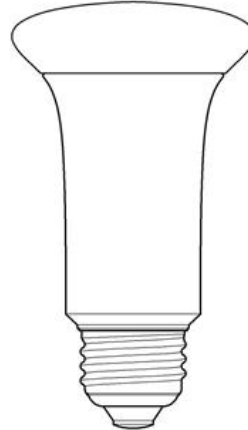

3.3

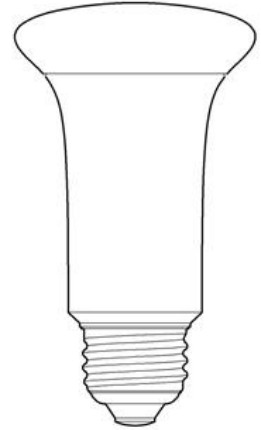

3.4

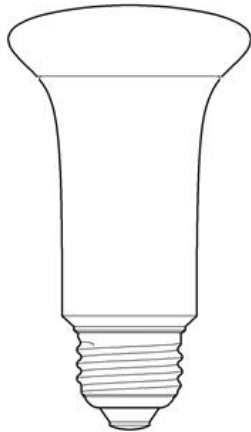

3.5

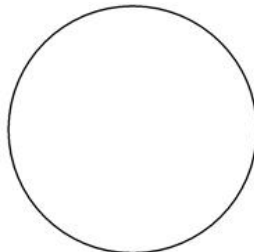

3.6

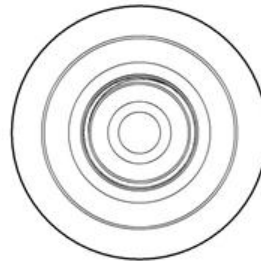

3.7

(11)	Reg.nr.:	DM/079266
(21)	Søkn.nr.:	20120994
(22)	Inngitt i WIPO:	2012.08.28
(15)	Registrert i WIPO:	2012.08.28
(24)	Løpedag:	2012.08.28
(43)	Allm. tilgj.:	2013.03.01
(15)	Besluttet gjeldende NO:	2013.03.04
(45)	Kunngjort NO:	2013.04.02
(18)	Reg. gjelder til:	2017.08.28
(73)	Innehaver:	Phoenix Product Development Ltd, Unit 1 West Point, 11 Durham Road, GB-SS156PH BASILDON, ESSEX, Storbritannia
(50)	Anmerkninger:	Registreringen gjelder samregistrering.

Design 1

(54)	Produkt:	Water closets
(51)	Klasse:	23-02
(72)	Designer:	Garry Moore, Unit 1 West Point, 11 Durham Road, SS156PH BASILDON, ESSEX, Storbritannia (GB)
(30)	Prioritet:	2012.02.28, EM, 001999301
(55)	Designavbildninger:	



1.1

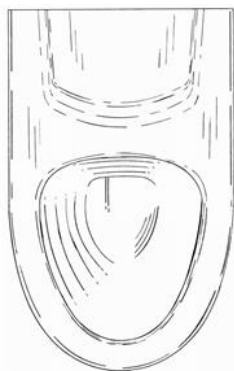

1.2



1.3



1.4



1.5

Design 2

- (54) **Produkt:** Water closets
(51) **Klasse:** 23-02
(72) **Designer:** Garry Moore, Unit 1 West Point, 11 Durham Road, SS156PH BASILDON, ESSEX, Storbritannia (GB)
(30) **Prioritet:** 2012.02.28, EM, 001999301
(55) **Designavbildninger:**



2.1

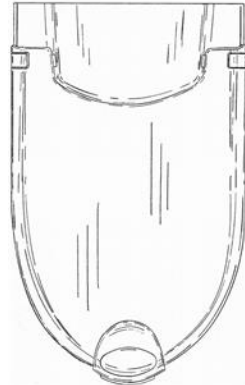

2.2

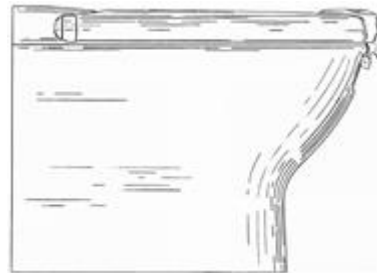

2.3

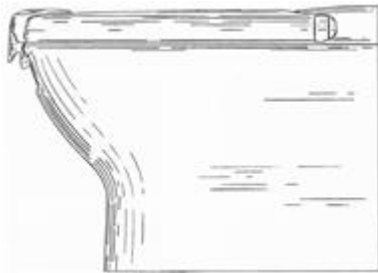

2.4



2.5

(11)	Reg.nr.:	DM/079359
(21)	Søkn.nr.:	20121016
(22)	Inngitt i WIPO:	2012.09.05
(15)	Registrert i WIPO:	2012.09.05
(24)	Løpedag:	2012.09.05
(43)	Allm. tilgj.:	2012.11.09
(15)	Besluttet gjeldende NO:	2013.03.15
(45)	Kunngjort NO:	2013.04.02
(18)	Reg. gjelder til:	2017.09.05
(73)	Innehaver:	Hermann Staib GmbH, Grimmigweg 27, DE-75179 PFORZHEIM, Tyskland
(50)	Anmerkninger:	Designen er i farger.

Design 1

(54)	Produkt:	Bracelet
(51)	Klasse:	11-01
(72)	Designer:	N N
(50)	Anmerkning:	Designen er i farger.
(55)	Designavbildninger:	



1.1

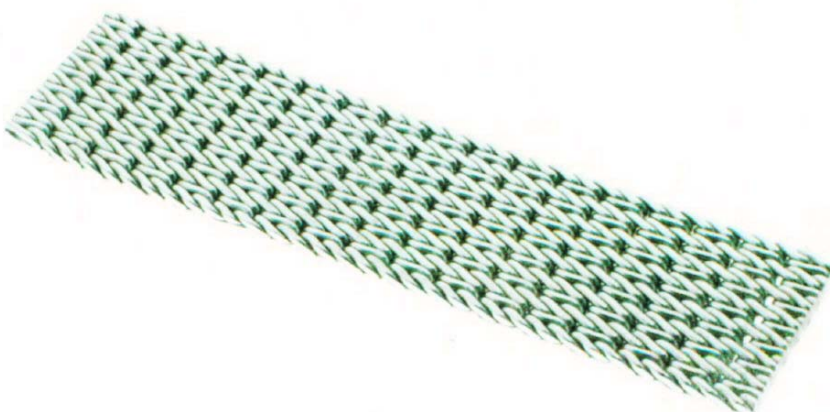

1.2



1.3

(11)	Reg.nr.:	DM/079570
(21)	Søkn.nr.:	20121125
(22)	Inngitt i WIPO:	2012.11.07
(15)	Registrert i WIPO:	2012.11.07
(24)	Løpedag:	2012.11.07
(43)	Allm. tilgj.:	2012.12.07
(15)	Besluttet gjeldende NO:	2013.03.13
(45)	Kunngjort NO:	2013.04.02
(18)	Reg. gjelder til:	2017.11.07
(73)	Innehaver:	Rundpack AG, Rheinstraße 38, CH-9444 DIEPOLDSAU, Sveits
(50)	Anmerkninger:	Registreringen gjelder samregistrering.

Design 1

(54)	Produkt:	Closures for containers
(51)	Klasse:	09-07
(72)	Designer:	Jan Srnka, Komenského 788, 76312 VIZOVICE, Tsjekkoslovakia (CS)
(55)	Designavbildninger:	



1.1



1.2



1.3



1.4



1.5



1.6



1.7

Design 2

(54)	Produkt:	Closures for containers
(51)	Klasse:	09-07
(72)	Designer:	Jan Srnka, Komenského 788, 76312 VIZOVICE, Tsjekkoslovakia (CS)
(55)	Designavbildninger:	



2.1



2.2



2.3



2.4



2.5



2.6



2.7

Design 3

(54)	Produkt:	Closures for containers
(51)	Klasse:	09-07
(72)	Designer:	Jan Srnka, Komenského 788, 76312 VIZOVICE, Tsjekkoslovakia (CS)
(55)	Designavbildninger:	



3.1



3.2



3.3



3.4



3.5



3.6



3.7

Design 4

(54)
(51)
(72)
(55)

Produkt:
Klasse:
Designer:
Designavbildninger:

Closures for containers
09-07
Jan Srnka, Komenského 788, 76312 VIZOVICE, Tsjekkoslovakia (CS)



4.1



4.2



4.3



4.4



4.5



4.6



4.7

Design 5

(54)

Produkt:

Closures for containers

(51)

Klasse:

09-07

(72)

Designer:

Jan Srnka, Komenského 788, 76312 VIZOVICE, Tsjekkoslovakia (CS)

(55)

Designavbildninger:

5.1



5.2



5.3



5.4



5.5



5.6



5.7

Design 6

(54)	Produkt:	Closures for containers
(51)	Klasse:	09-07
(72)	Designer:	Jan Srnka, Komenského 788, 76312 VIZOVICE, Tsjekkoslovakia (CS)
(55)	Designavbildninger:	



6.1



6.2



6.3



6.4



6.5



6.6



6.7

Design 7

(54)	Produkt:	Closures for containers
(51)	Klasse:	09-07
(72)	Designer:	Jan Srnka, Komenského 788, 76312 VIZOVICE, Tsjekkoslovakia (CS)
(55)	Designavbildninger:	



7.1

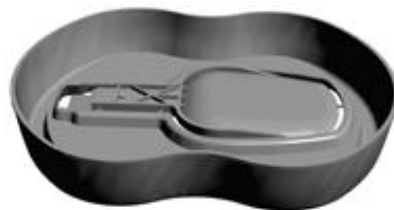

7.2



7.3



7.4



7.5



7.6



7.7

Design 8

- (54)
- (51)
- (72)
- (55)

Produkt:
Klasse:
Designer:
Designavbildninger:

Closures for containers
09-07
Jan Srnka, Komenského 788, 76312 VIZOVICE, Tsjekkoslovakia (CS)



8.1



8.2



8.3



8.4



8.5



8.6



8.7

Design 9

- (54) **Produkt:** Closures for containers
(51) **Klasse:** 09-07
(72) **Designer:** Jan Srnka, Komenského 788, 76312 VIZOVICE, Tsjekkoslovakia (CS)
(55) **Designavbildninger:**



9.1



9.2



9.3



9.4



9.5



9.6

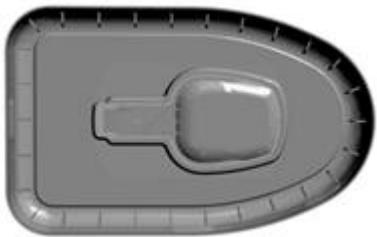

9.7

Design 10

- (54) **Produkt:** Closures for containers
(51) **Klasse:** 09-07
(72) **Designer:** Jan Srnka, Komenského 788, 76312 VIZOVICE, Tsjekkoslovakia (CS)
(55) **Designavbildninger:**



10.1



10.2



10.3



10.4



10.5



10.6



10.7

Design 11

- (54) **Produkt:** Closures for containers
(51) **Klasse:** 09-07
(72) **Designer:** Jan Srnka, Komenského 788, 76312 VIZOVICE, Tsjekkoslovakia (CS)
(55) **Designavbildninger:**



11.1



11.2



11.3



11.4



11.5



11.6



11.7

Design 12

(54) **Produkt:** Closures for containers
(51) **Klasse:** 09-07
(72) **Designer:** Jan Srnka, Komenského 788, 76312 VIZOVICE, Tsjekkoslovakia (CS)
(55) **Designavbildninger:**



12.1



12.2



12.3



12.4



12.5



12.6



12.7

Design 13

(54) **Produkt:** Closures for containers
(51) **Klasse:** 09-07
(72) **Designer:** Jan Srnka, Komenského 788, 76312 VIZOVICE, Tsjekkoslovakia (CS)
(55) **Designavbildninger:**



13.1



13.2



13.3



13.4



13.5



13.6



13.7

(11)	Reg.nr.:	DM/079578
(21)	Søkn.nr.:	20121129
(22)	Inngitt i WIPO:	2012.11.26
(15)	Registrert i WIPO:	2012.11.26
(24)	Løpedag:	2012.11.26
(43)	Allm. tilgj.:	2012.12.07
(15)	Besluttet gjeldende NO:	2013.03.13
(45)	Kunngjort NO:	2013.04.02
(18)	Reg. gjelder til:	2017.11.26
(73)	Innehaver:	Rosenbauer International AG, Paschinger Strasse 90, AT-4060 LEONDING, Østerrike

Design 1

(54)	Produkt:	Fireproof garment
(51)	Klasse:	02-02
(72)	Designer:	Hermann Wieser, Oberschnadterstrasse 15, 4055 PUCKING, Østerrike (AT)
(30)	Prioritet:	2012.06.26, EM, 002063974
(55)	Designavbildninger:	

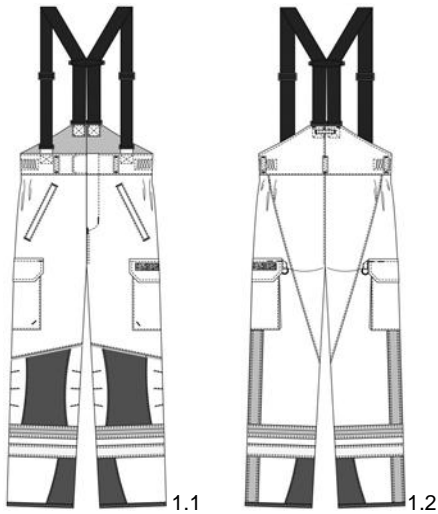

(11)	Reg.nr.:	DM/079678
(21)	Søkn.nr.:	20130056
(22)	Inngitt i WIPO:	2012.08.27
(15)	Registrert i WIPO:	2012.08.27
(24)	Løpedag:	2012.08.27
(43)	Allm. tilgj.:	2013.03.01
(15)	Besluttet gjeldende NO:	2013.03.08
(45)	Kunngjort NO:	2013.04.02
(18)	Reg. gjelder til:	2017.08.27
(73)	Innehaver:	Bischoff+Scheck AG, Victoria Boulevard D 100, DE-77836 RHEINMÜNSTER/BADEN-AIRPARK, Tyskland
(50)	Anmerkninger:	Design nr. 7 - 10 er i farger. Registreringen gjelder samregistrering.

Design 1

(54)	Produkt:	Pavilions [transportable building]
(51)	Klasse:	25-03
(72)	Designer:	Volker Scheck, Victoria Boulevard D100, 77836 RHEINMÜNSTER/BADEN-AIRPARK, Tyskland (DE)
(30)	Prioritet:	2012.04.05, EM, 002021212
(55)	Designavbildninger:	

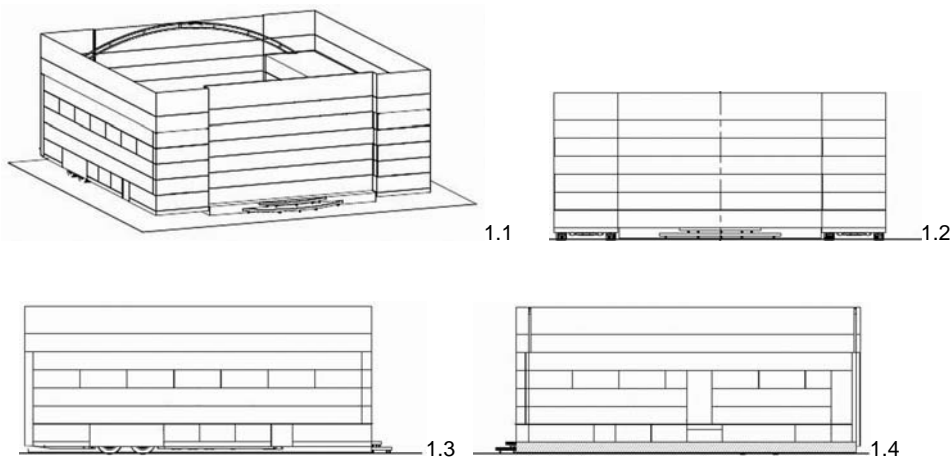
**Design 2**

(54)	Produkt:	Pavilions [transportable building]
(51)	Klasse:	25-03
(72)	Designer:	Volker Scheck, Victoria Boulevard D100, 77836 RHEINMÜNSTER/BADEN-AIRPARK, Tyskland (DE)
(30)	Prioritet:	2012.04.05, EM, 002021212
(55)	Designavbildninger:	



2.1

Design 3

- (54) **Produkt:** Pavilions [transportable building]
(51) **Klasse:** 25-03
(72) **Designer:** Volker Scheck, Victoria Boulevard D100, 77836 RHEINMÜNSTER/BADEN-AIRPARK, Tyskland (DE)
(30) **Prioritet:** 2012.04.05, EM, 002021212
(55) **Designavbildninger:**



3.1

Design 4

- (54) **Produkt:** Pavilions [transportable building]
(51) **Klasse:** 25-03
(72) **Designer:** Volker Scheck, Victoria Boulevard D100, 77836 RHEINMÜNSTER/BADEN-AIRPARK, Tyskland (DE)
(30) **Prioritet:** 2012.04.05, EM, 002021212
(55) **Designavbildninger:**



4.1

Design 5

- (54) **Produkt:** Pavilions [transportable building]
(51) **Klasse:** 25-03
(72) **Designer:** Volker Scheck, Victoria Boulevard D100, 77836 RHEINMÜNSTER/BADEN-AIRPARK, Tyskland (DE)
(30) **Prioritet:** 2012.04.05, EM, 002021212
(55) **Designavbildninger:**



5.1

Design 6

- (54) **Produkt:** Pavilions [transportable building]
(51) **Klasse:** 25-03
(72) **Designer:** Volker Scheck, Victoria Boulevard D100, 77836 RHEINMÜNSTER/BADEN-AIRPARK, Tyskland (DE)
(30) **Prioritet:** 2012.04.05, EM, 002021212
(55) **Designavbildninger:**



6.1

Design 7

- (54) **Produkt:** Pavilions [transportable building]
(51) **Klasse:** 25-03
(72) **Designer:** Volker Scheck, Victoria Boulevard D100, 77836 RHEINMÜNSTER/BADEN-AIRPARK, Tyskland (DE)
(30) **Prioritet:** 2012.04.05, EM, 002021212
(50) **Anmerkning:** Designen er i farger.
(55) **Designavbildninger:**



7.1

Design 8

- (54) **Produkt:** Pavilions [transportable building]
(51) **Klasse:** 25-03
(72) **Designer:** Volker Scheck, Victoria Boulevard D100, 77836 RHEINMÜNSTER/BADEN-AIRPARK, Tyskland (DE)
(30) **Prioritet:** 2012.04.05, EM, 002021212
(50) **Anmerkning:** Designen er i farger.
(55) **Designavbildninger:**



8.1

Design 9

- (54) **Produkt:** Pavilions [transportable building]
(51) **Klasse:** 25-03
(72) **Designer:** Volker Scheck, Victoria Boulevard D100, 77836 RHEINMÜNSTER/BADEN-AIRPARK, Tyskland (DE)
(30) **Prioritet:** 2012.04.05, EM, 002021212
(50) **Anmerkning:** Designen er i farger.
(55) **Designavbildninger:**



9.1

Design 10

(54)	Produkt:	Pavilions [transportable building]
(51)	Klasse:	25-03
(72)	Designer:	Volker Scheck, Victoria Boulevard D100, 77836 RHEINMÜNSTER/BADEN-AIRPARK, Tyskland (DE)
(30)	Prioritet:	2012.04.05, EM, 002021212
(50)	Anmerkning:	Designen er i farger.
(55)	Designavbildninger:	



10.1

(11)	Reg.nr.:	DM/079680
(21)	Søkn.nr.:	20130057
(22)	Inngitt i WIPO:	2012.08.31
(15)	Registrert i WIPO:	2012.08.31
(24)	Løpedag:	2012.08.31
(43)	Allm. tilgj.:	2013.03.01
(15)	Besluttet gjeldende NO:	2013.03.08
(45)	Kunngjort NO:	2013.04.02
(18)	Reg. gjelder til:	2017.08.31
(73)	Innehaver:	Philip Morris Products SA, Quai Jeanrenaud 3, CH-2000 NEUCHÂTEL , Sveits
(50)	Anmerkninger:	Registreringen gjelder samregistrering.

Design 1

(54)	Produkt:	Hand-held aerosol generators
(51)	Klasse:	27-99
(72)	Designert:	Frederic Lavanchy, Route de la Brinaz 13, 1422 GRANDSON, Sveits (CH) Aleksandra Samulewicz, Jasminowa 2/4, 02-717 WARSAWA, Polen (PL) Oleg Mironov, Battieux 1, 2000 NEUCHÂTEL, Sveits (CH) Stéphane Roudier, Rue du Sentier 2c, 2013 COLOMBIER, Sveits (CH) Roberto Mancini, Route d'Arnex 2, 1353 BOFFLENS, Sveits (CH)
(30)	Prioritet:	2012.03.12, EM, 001317556
(55)	Designavbildninger:	

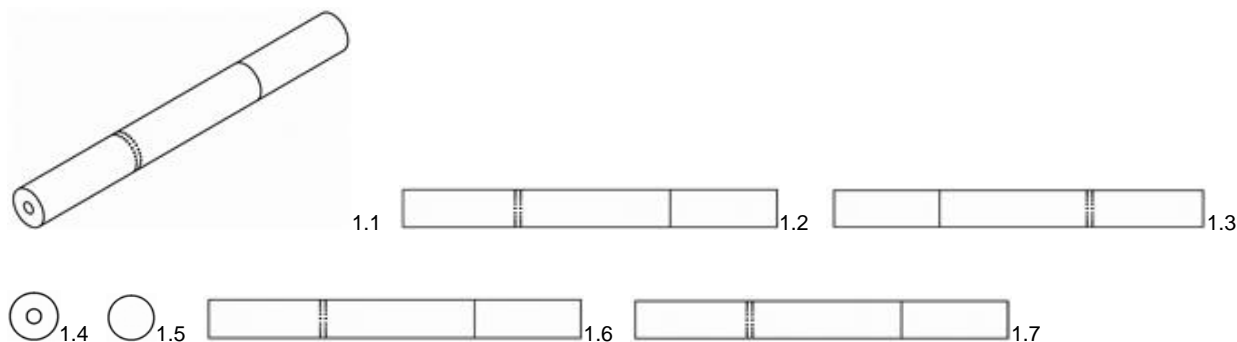
**Design 2**

(54)	Produkt:	Hand-held aerosol generators
(51)	Klasse:	27-99
(72)	Designert:	Frederic Lavanchy, Route de la Brinaz 13, 1422 GRANDSON, Sveits (CH) Aleksandra Samulewicz, Jasminowa 2/4, 02-717 WARSAWA, Polen (PL) Oleg Mironov, Battieux 1, 2000 NEUCHÂTEL, Sveits (CH) Stéphane Roudier, Rue du Sentier 2c, 2013 COLOMBIER, Sveits (CH) Roberto Mancini, Route d'Arnex 2, 1353 BOFFLENS, Sveits (CH)
(30)	Prioritet:	2012.03.12, EM, 001317556
(55)	Designavbildninger:	

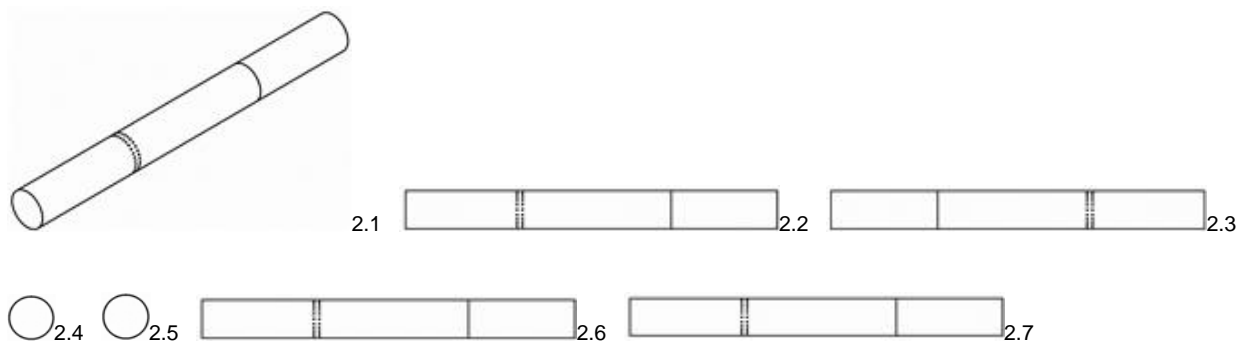

Design 3

- (54) **Produkt:** Hand-held aerosol generators
 (51) **Klasse:** 27-99
 (72) **Designer:** Frederic Lavanchy, Route de la Brinaz 13, 1422 GRANDSON, Sveits (CH)
 Aleksandra Samulewicz, Jasminowa 2/4, 02-717 WARSAWA, Polen (PL)
 Oleg Mironov, Battieux 1, 2000 NEUCHÂTEL, Sveits (CH)
 Stéphane Roudier, Rue du Sentier 2c, 2013 COLOMBIER, Sveits (CH)
 Roberto Mancini, Route d'Arnex 2, 1353 BOFFLENS, Sveits (CH)
- (30) **Prioritet:** 2012.03.12, EM, 001317556
- (55) **Designavbildninger:**

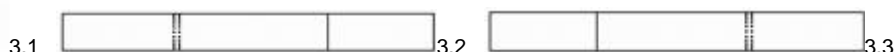
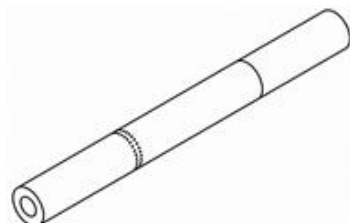
**Design 4**

- (54) **Produkt:** Hand-held aerosol generators
 (51) **Klasse:** 27-99
 (72) **Designer:** Frederic Lavanchy, Route de la Brinaz 13, 1422 GRANDSON, Sveits (CH)
 Aleksandra Samulewicz, Jasminowa 2/4, 02-717 WARSAWA, Polen (PL)
 Oleg Mironov, Battieux 1, 2000 NEUCHÂTEL, Sveits (CH)
 Stéphane Roudier, Rue du Sentier 2c, 2013 COLOMBIER, Sveits (CH)
 Roberto Mancini, Route d'Arnex 2, 1353 BOFFLENS, Sveits (CH)
- (30) **Prioritet:** 2012.03.12, EM, 001317556
- (55) **Designavbildninger:**

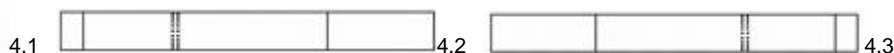
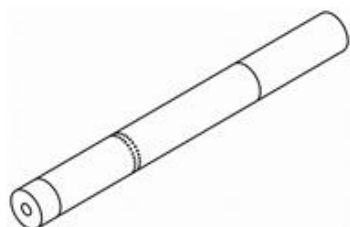

Design 5

- (54) **Produkt:** Hand-held aerosol generators
 (51) **Klasse:** 27-99
 (72) **Designer:** Frederic Lavanchy, Route de la Brinaz 13, 1422 GRANDSON, Sveits (CH)
 Aleksandra Samulewicz, Jasminowa 2/4, 02-717 WARSAWA, Polen (PL)
 Oleg Mironov, Battieux 1, 2000 NEUCHÂTEL, Sveits (CH)
 Stéphane Roudier, Rue du Sentier 2c, 2013 COLOMBIER, Sveits (CH)
 Roberto Mancini, Route d'Arnex 2, 1353 BOFFLENS, Sveits (CH)
- (30) **Prioritet:** 2012.03.12, EM, 001317556
 (55) **Designavbildninger:**

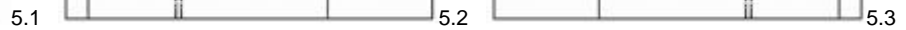
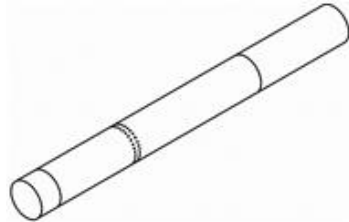
**Design 6**

- (54) **Produkt:** Hand-held aerosol generators
 (51) **Klasse:** 27-99
 (72) **Designer:** Frederic Lavanchy, Route de la Brinaz 13, 1422 GRANDSON, Sveits (CH)
 Aleksandra Samulewicz, Jasminowa 2/4, 02-717 WARSAWA, Polen (PL)
 Oleg Mironov, Battieux 1, 2000 NEUCHÂTEL, Sveits (CH)
 Stéphane Roudier, Rue du Sentier 2c, 2013 COLOMBIER, Sveits (CH)
 Roberto Mancini, Route d'Arnex 2, 1353 BOFFLENS, Sveits (CH)
- (30) **Prioritet:** 2012.03.12, EM, 001317556
 (55) **Designavbildninger:**

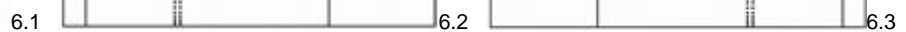
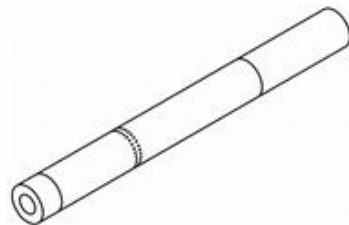

Design 7

- (54) **Produkt:** Hand-held aerosol generators
 (51) **Klasse:** 27-99
 (72) **Designer:** Frederic Lavanchy, Route de la Brinaz 13, 1422 GRANDSON, Sveits (CH)
 Aleksandra Samulewicz, Jasminowa 2/4, 02-717 WARSAWA, Polen (PL)
 Oleg Mironov, Battieux 1, 2000 NEUCHÂTEL, Sveits (CH)
 Stéphane Roudier, Rue du Sentier 2c, 2013 COLOMBIER, Sveits (CH)
 Roberto Mancini, Route d'Arnex 2, 1353 BOFFLENS, Sveits (CH)
- (30) **Prioritet:** 2012.03.12, EM, 001317556
- (55) **Designavbildninger:**

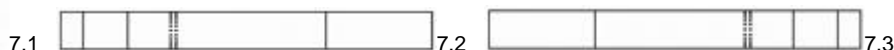
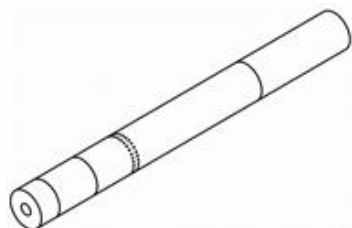
**Design 8**

- (54) **Produkt:** Hand-held aerosol generators
 (51) **Klasse:** 27-99
 (72) **Designer:** Frederic Lavanchy, Route de la Brinaz 13, 1422 GRANDSON, Sveits (CH)
 Aleksandra Samulewicz, Jasminowa 2/4, 02-717 WARSAWA, Polen (PL)
 Oleg Mironov, Battieux 1, 2000 NEUCHÂTEL, Sveits (CH)
 Stéphane Roudier, Rue du Sentier 2c, 2013 COLOMBIER, Sveits (CH)
 Roberto Mancini, Route d'Arnex 2, 1353 BOFFLENS, Sveits (CH)
- (30) **Prioritet:** 2012.03.12, EM, 001317556
- (55) **Designavbildninger:**

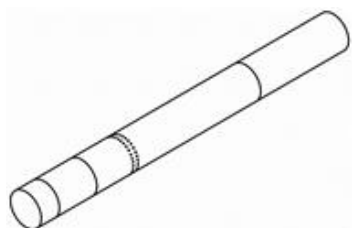

Design 9

- (54) **Produkt:** Hand-held aerosol generators
(51) **Klasse:** 27-99
(72) **Designer:** Frederic Lavanchy, Route de la Brinaz 13, 1422 GRANDSON, Sveits (CH)
Aleksandra Samulewicz, Jasminowa 2/4, 02-717 WARSAWA, Polen (PL)
Oleg Mironov, Battieux 1, 2000 NEUCHÂTEL, Sveits (CH)
Stéphane Roudier, Rue du Sentier 2c, 2013 COLOMBIER, Sveits (CH)
Roberto Mancini, Route d'Arnex 2, 1353 BOFFLENS, Sveits (CH)
- (30) **Prioritet:** 2012.03.12, EM, 001317556
(55) **Designavbildninger:**

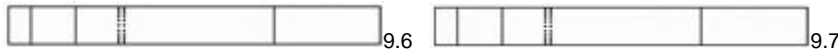
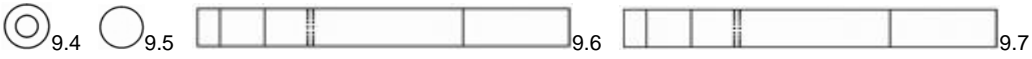
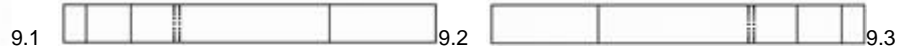
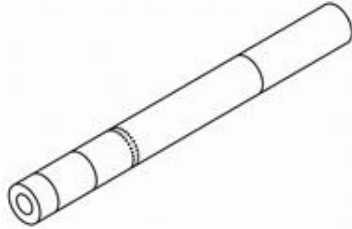

(11)	Reg.nr.:	DM/079813
(21)	Søkn.nr.:	20130109
(22)	Inngitt i WIPO:	2012.11.02
(15)	Registrert i WIPO:	2012.11.02
(24)	Løpedag:	2012.11.02
(43)	Allm. tilgj.:	2013.01.04
(15)	Besluttet gjeldende NO:	2013.03.08
(45)	Kunngjort NO:	2013.04.02
(18)	Reg. gjelder til:	2017.11.02
(73)	Innehaver:	Tegometall International AG, Industriestrasse 7, CH-8574 LENGWIL, Sveits
(50)	Anmerkninger:	Registreringen gjelder samregistrering.

Design 1

(54)	Produkt:	Rack shelves
(51)	Klasse:	06-06
(72)	Designer:	Ulrich Bohnacker, c/o Tegometall International AG, Industriestr. 7, 8574 LENGWIL, Sveits (CH)
(30)	Prioritet:	2012.05.04, EM, 001324768
(55)	Designavbildninger:	

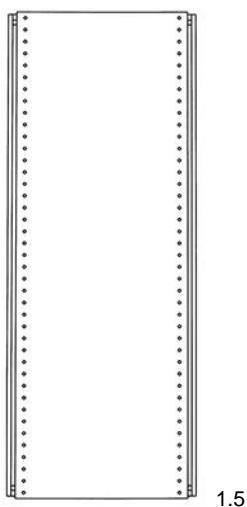
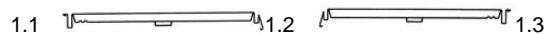
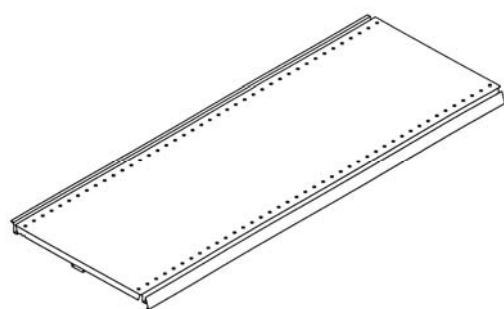

Design 2

(54) **Produkt:** Rack shelves
(51) **Klasse:** 06-06
(72) **Designer:** Ulrich Bohnacker, c/o Tegometall International AG, Industriestr. 7, 8574 LENGWIL, Sveits (CH)
(30) **Prioritet:** 2012.05.04, EM, 001324768
(55) **Designavbildninger:**

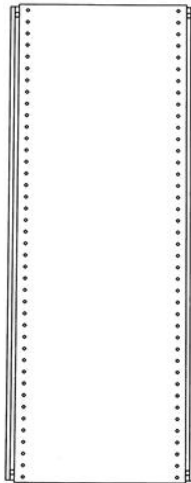
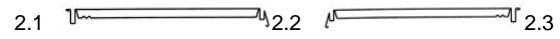
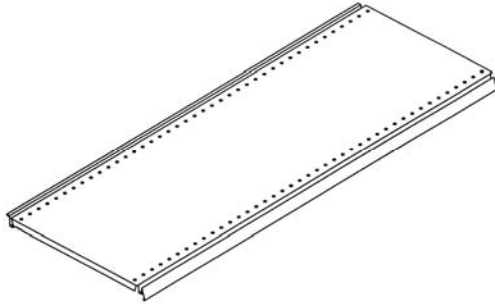

2.5

(11)	Reg.nr.:	DM/079825
(21)	Søkn.nr.:	20130147
(22)	Inngitt i WIPO:	2012.09.21
(15)	Registrert i WIPO:	2012.09.21
(24)	Løpedag:	2012.09.21
(43)	Allm. tilgj.:	2013.01.18
(15)	Besluttet gjeldende NO:	2013.03.05
(45)	Kunngjort NO:	2013.04.02
(18)	Reg. gjelder til:	2017.09.21
(73)	Innehaver:	Koziol Ideas for Friends GmbH, Werner-von-Siemens-Straße 90, DE-64711 ERBACH, Tyskland
(50)	Anmerkninger:	Registreringen gjelder samregistrering.

Design 1

(54)	Produkt:	Tea strainer
(51)	Klasse:	07-01 07-03 07-04 07-06
(72)	Designer:	Jürgen Diehl, Am Hang 8, 64720 MICHELSTADT, Tyskland (DE)
(30)	Prioritet:	2012.04.07, DE, 40 2012 001 648.9
(55)	Designavbildninger:	



1.1

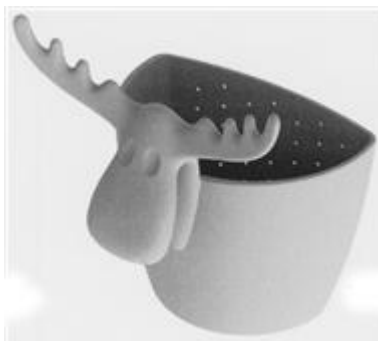

1.2



1.3

Design 2

(54)	Produkt:	Strainer
(51)	Klasse:	07-01 07-03 07-04 07-06
(72)	Designer:	Caim Young, Clements Yard, Illiffe Street, Southwark, SE173LU LONDON, Storbritannia (GB)
(30)	Prioritet:	2012.04.07, DE, 40 2012 001 648.9
(55)	Designavbildninger:	



2.1

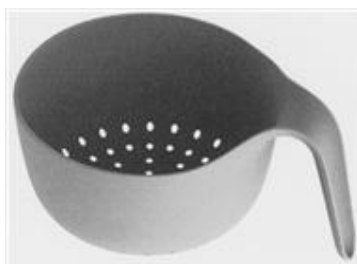

2.2

Design 3

- (54) **Produkt:** Kitchen grater
(51) **Klasse:** 07-01
07-03
07-04
07-06
(72) **Designer:** Ruud Belmans, Hessenplein 2, 2000 ANTWERPEN, Belgia (BE)
(30) **Prioritet:** 2012.04.07, DE, 40 2012 001 648.9
(55) **Designavbildninger:**

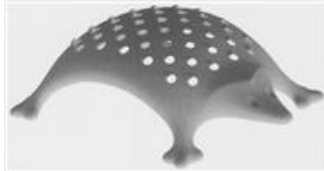

3.1



3.2

Design 4

- (54) **Produkt:** Knive (tableware)
(51) **Klasse:** 07-01
07-03
07-04
07-06
(72) **Designer:** Jürgen Diehl, Am Hang 8, 64720 MICHELSTADT, Tyskland (DE)
(30) **Prioritet:** 2012.04.07, DE, 40 2012 001 648.9
(55) **Designavbildninger:**



4.1



4.2



4.3

Design 5

- (54) **Produkt:** Cook cutter
 (51) **Klasse:** 07-04
 07-06
 07-01
 07-03
 (72) **Designer:** Jürgen Diehl, Am Hang 8, 64720 MICHELSTADT, Tyskland (DE)
 (30) **Prioritet:** 2012.04.07, DE, 40 2012 001 648.9
 (55) **Designavbildninger:**



5.1

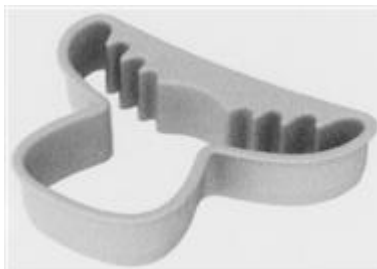

5.2

Design 6

- (54) **Produkt:** Trivets
 (51) **Klasse:** 07-01
 07-03
 07-04
 07-06
 (72) **Designer:** Jürgen Diehl, Am Hang 8, 64720 MICHELSTADT, Tyskland (DE)
 (30) **Prioritet:** 2012.04.07, DE, 40 2012 001 648.9
 (55) **Designavbildninger:**



6.1

Design 7

- (54) **Produkt:** Chopping board
 (51) **Klasse:** 07-01
 07-03
 07-04
 07-06
 (72) **Designer:** Jürgen Diehl, Am Hang 8, 64720 MICHELSTADT, Tyskland (DE)
 (30) **Prioritet:** 2012.04.07, DE, 40 2012 001 648.9
 (55) **Designavbildninger:**



7.1



7.2

(11)	Reg.nr.:	DM/079839
(21)	Søkn.nr.:	20130153
(22)	Inngitt i WIPO:	2012.11.28
(15)	Registrert i WIPO:	2012.11.28
(24)	Løpedag:	2012.11.28
(43)	Allm. tilgj.:	2013.01.18
(15)	Besluttet gjeldende NO:	2013.03.05
(45)	Kunngjort NO:	2013.04.02
(18)	Reg. gjelder til:	2017.11.28
(73)	Innehaver:	Ivar Frischer, Karl Gustavsgatan 31 Igh 1402, SE-41125 GÖTEBORG, Sverige Markus Hallberg, Bukärrsvägen 1, SE-42941 SÄRÖ, Sverige Fredrik Lotto, Ättehögsgatan 7F, SE-41674 GÖTEBORG, Sverige Jon Holmdahl, Övre Djupedahlgatan 11B, SE-41307 GÖTEBORG, Sverige Matias Cindric, Stensjöberg 17, SE-43136 MÖLNDAL, Sverige Tina Thörner, Unterdorfstrasse 3, CH-8269 FRUTWILEN, Sveits

Design 1

(54)	Produkt:	Pillow
(51)	Klasse:	06-09
(72)	Designer:	Ivar Frischer, Karl Gustavsgatan 31 Igh 1402, 41125 GÖTEBORG, Sverige (SE) Markus Hallberg, Bukärrsvägen 1, 42941 SÄRÖ, Sverige (SE) Fredrik Lotto, Ättehögsgatan 7F, 41674 GÖTEBORG, Sverige (SE) Jon Holmdahl, Övre Djupedahlgatan 11B, 41307 GÖTEBORG, Sverige (SE) Matias Cindric, Stensjöberg 17, 43136 MÖLNDAL, Sverige (SE)
(55)	Designavbildninger:	

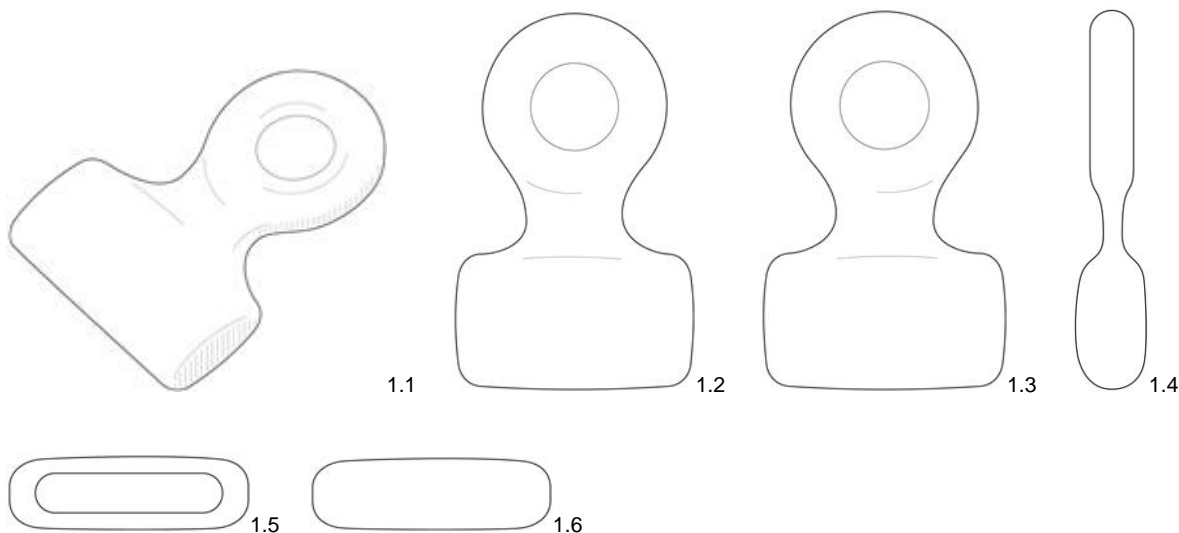

(11)	Reg.nr.:	DM/079880
(21)	Søkn.nr.:	20130167
(22)	Inngitt i WIPO:	2012.09.19
(15)	Registrert i WIPO:	2012.09.19
(24)	Løpedag:	2012.09.19
(43)	Allm. tilgj.:	2013.01.25
(15)	Besluttet gjeldende NO:	2013.03.08
(45)	Kunngjort NO:	2013.04.02
(18)	Reg. gjelder til:	2017.09.19
(73)	Innehaver:	Koziol Ideas for Friends GmbH, Werner-von-Siemens-Straße 90, DE-64711 ERBACH, Tyskland
(50)	Anmerkninger:	Registreringen gjelder samregistrering.

Design 1

(54)	Produkt:	Holder for jewelry
(51)	Klasse:	11-01
(72)	Designer:	Sandra Weber, Martin-Luther-Strasse 9, 64732 BAD KÖNING, Tyskland (DE)
(30)	Prioritet:	2012.04.04, DE, 40 2012 001 582.2
(55)	Designavbildninger:	



1.1



1.2

Design 2

(54)	Produkt:	Festive decoration
(51)	Klasse:	11-05
(72)	Designer:	Sandra Weber, Martin-Luther-Strasse 9, 64732 BAD KÖNING, Tyskland (DE)
(30)	Prioritet:	2012.04.04, DE, 40 2012 001 582.2
(55)	Designavbildninger:	



2.1



2.2

(11)	Reg.nr.:	DM/079903
(21)	Søkn.nr.:	20130170
(22)	Inngitt i WIPO:	2013.01.09
(15)	Registrert i WIPO:	2013.01.09
(24)	Løpedag:	2013.01.09
(43)	Allm. tilgj.:	2013.01.25
(15)	Besluttet gjeldende NO:	2013.03.08
(45)	Kunngjort NO:	2013.04.02
(18)	Reg. gjelder til:	2018.01.09
(73)	Innehaver:	Eurofire AB, Petrus Timmelins väg 59, SE-25477 FLENINGE, Sverige
(50)	Anmerkninger:	Registreringen gjelder samregistrering.

Design 1

(54)	Produkt:	Fire pans
(51)	Klasse:	23-03
(72)	Designer:	Jonny Siöström, Petrus Timmelins väg 59, 25477 FLENINGE, Sverige (SE)
(55)	Designavbildninger:	



1.1



1.2



1.3

Design 2

(54)	Produkt:	Fire pans
(51)	Klasse:	23-03
(72)	Designer:	Jonny Siöström, Petrus Timmelins väg 59, 25477 FLENINGE, Sverige (SE)
(55)	Designavbildninger:	



2.1



2.2



2.3

Design 3

- (54) **Produkt:** Fire pans
(51) **Klasse:** 23-03
(72) **Designer:** Jonny Siöström, Petrus Timmelins väg 59, 25477 FLENINGE, Sverige (SE)
(55) **Designavbildninger:**



3.1



3.2



3.3

Design 4

- (54) **Produkt:** Fire pans
(51) **Klasse:** 23-03
(72) **Designer:** Jonny Siöström, Petrus Timmelins väg 59, 25477 FLENINGE, Sverige (SE)
(55) **Designavbildninger:**

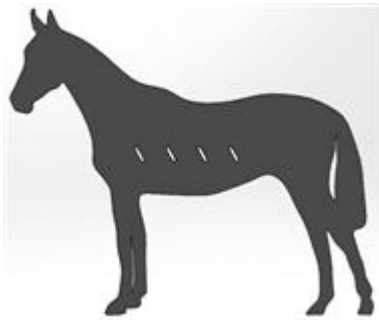

4.1

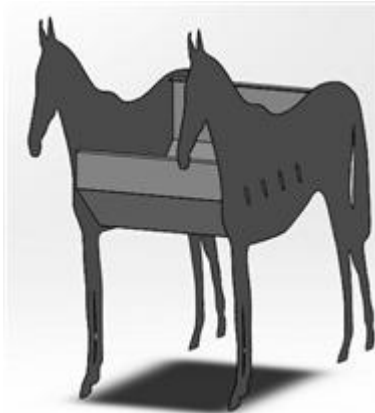

4.2

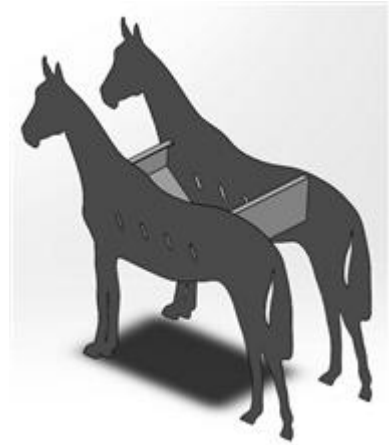

4.3

Design 5

- (54) **Produkt:** Fire pans
(51) **Klasse:** 23-03
(72) **Designer:** Jonny Siöström, Petrus Timmelins väg 59, 25477 FLENINGE, Sverige (SE)
(55) **Designavbildninger:**



5.1

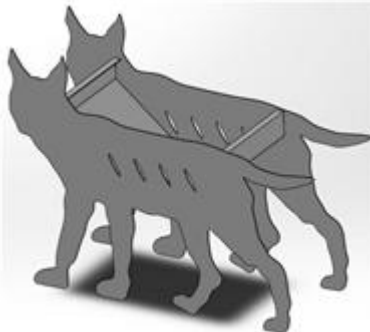

5.2



5.3

Design 6

- (54) **Produkt:** Fire pans
(51) **Klasse:** 23-03
(72) **Designer:** Jonny Siöström, Petrus Timmelins väg 59, 25477 FLENINGE, Sverige (SE)
(55) **Designavbildninger:**



6.1



6.2

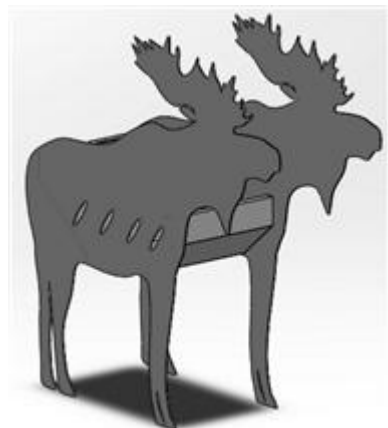

6.3

Design 7

- (54) **Produkt:** Fire pans
(51) **Klasse:** 23-03
(72) **Designer:** Jonny Siöström, Petrus Timmelins väg 59, 25477 FLENINGE, Sverige (SE)
(55) **Designavbildninger:**



7.1



7.2



7.3

Design 8

- (54) **Produkt:** Fire pans
(51) **Klasse:** 23-03
(72) **Designer:** Jonny Siöström, Petrus Timmelins väg 59, 25477 FLENINGE, Sverige (SE)
(55) **Designavbildninger:**



8.1



8.2



8.3

Overdragelser

- (11) **Reg.nr.:** 078260
(21) **Søknadsnr.** 20030602
(73) **Innehaver:** Finlandia Vodka Worldwide Ltd,
Porkkalankatu 24, FI-00180
HELSINGFORS, Finland
(74) **Fullmektig:** Acapo AS, Postboks 1880 Nordnes,
5817 BERGEN, Norge
-

- (11) **Reg.nr.:** 080465
(21) **Søknadsnr.** 20060603
(73) **Innehaver:** Interpallet AS, c/o Magnolia System AS,
Nordbyveien 21, 1400 SKI, Norge
(74) **Fullmektig:** Håmsø Patentbyrå ANS, Postboks 171,
4302 SANDNES, Norge
-

Endringer i fullmaktsforhold

(11) **Reg.nr.:** **078032**
(21) **Søknadsnr.** 20030176
(74) **Fullmektig:** Onsagers AS, Postboks 1813
Vika, 0123 OSLO, Norge

(11) **Reg.nr.:** **082839**
(21) **Søknadsnr.** 20100623
(73) **Innehaver:** Cloetta AB, Hjalmar Svenfelts
väg, SE-59069 LJUNGSBRO,
Sverige
(74) **Fullmektig:** Setterwalls Advokatbyrå
Malmö AB, Box 4501, SE-
20320 MALMÖ, Sverige

(11) **Reg.nr.:** **083738**
(21) **Søknadsnr.** 20120718
(73) **Innehaver:** Sætre AS, Sandakerveien 56,
0401 OSLO, Norge
(74) **Fullmektig:** Onsagers AS, Postboks 1813
Vika, 0123 OSLO, Norge

Fornyelse av registreringer

(11) **Reg.nr:** 071269 **Fornyhet til:** 2018.04.05
(73) **Innehaver:** Autoadapt-BEV AB, Hedeforsvägen 6, 44361, STENKULLEN, SE
(74) **Fullmektig:** Håmsø Patentbyrå ANS, Postboks 171, 4302, SANDNES, NO

(11) **Reg.nr:** 077498 **Fornyhet til:** 2018.05.05
(73) **Innehaver:** BabyBjörn AB, Box 913, 17009, SOLNA, SE
(74) **Fullmektig:** Onsagers AS, Postboks 1813 Vika, 0123, OSLO, NO

(11) **Reg.nr:** 077676 **Fornyhet til:** 2018.08.04
(73) **Innehaver:** Mars Norge AS, Hovfaret 13, 0275, OSLO, NO
(74) **Fullmektig:** Onsagers AS, Postboks 1813 Vika, 0123, OSLO, NO

(11) **Reg.nr:** 077729 **Fornyhet til:** 2018.05.28
(73) **Innehaver:** Diagnostica-Stago SA, 9 rue des Frères Chausson, 92600, ASNIÉRES, FR
(74) **Fullmektig:** Zacco Norway AS, Postboks 2003 Vika, 0125, OSLO, NO

(11) **Reg.nr:** 077933 **Fornyhet til:** 2018.05.09
(73) **Innehaver:** Saferoad AS, Postboks 34, 6151, ØRSTA, NO
(74) **Fullmektig:** Curo AS, Industriveien 53, 7080, HEIMDAL, NO

(11) **Reg.nr:** 078032 **Fornyhet til:** 2018.03.13
(73) **Innehaver:** Innovation Randers A/S, Blommevej 38, 8900, RANDERS, DK
(74) **Fullmektig:** Onsagers AS, Postboks 1813 Vika, 0123, OSLO, NO

(11) **Reg.nr:** 078455 **Fornyhet til:** 2018.08.26
(73) **Innehaver:** Design Ideas Ltd, 2521 Stockyard Road, IL62702, SPRINGFIELD, US
(74) **Fullmektig:** Zacco Norway AS, Postboks 2003 Vika, 0125, OSLO, NO

(11) **Reg.nr:** 078598 **Fornyhet til:** 2018.03.06
(73) **Innehaver:** Kronoplus Technical AG, Rütihofstrasse 1, 9052, NIEDERTEUFEN, CH
(74) **Fullmektig:** Acapo AS, Postboks 1880 Nordnes, 5817, BERGEN, NO

(11) **Reg.nr:** 078674 **Fornyhet til:** 2018.08.26
(73) **Innehaver:** Design Ideas Ltd, 2521 Stockyard Road, IL62702, SPRINGFIELD, US
(74) **Fullmektig:** Zacco Norway AS, Postboks 2003 Vika, 0125, OSLO, NO

(11) **Reg.nr:** 081130 **Fornyhet til:** 2017.10.11
(73) **Innehaver:** Anette Danielsson, Skidvägen 3, 12949, HÄGERSTEN, SE

(11) **Reg.nr:** 081201 **Fornyhet til:** 2018.03.06
(73) **Innehaver:** Les Robinets Presto SA, 7, rue Racine, 92120, MONTROUGE, FR
(74) **Fullmektig:** Tandbergs Patentkontor AS, Postboks 1570 Vika, 0118, OSLO, NO

(11) **Reg.nr:** 081239 **Fornyhet til:** 2018.03.11
(73) **Innehaver:** Recaro Child Safety GmbH & Co KG, Guttenbergstrasse 2, 95352, MARKTLEUGAST, GB
(74) **Fullmektig:** Onsagers AS, Postboks 1813 Vika, 0123, OSLO, NO

(11) **Reg.nr:** 081247 **Fornyhet til:** 2018.03.11
(73) **Innehaver:** VITRULAN Textilglas GmbH, Bernecker Strasse 8, 95509, MARKTSCHORGAST, DE
(74) **Fullmektig:** Oslo Patentkontor AS, Postboks 7007 Majorstua, 0306, OSLO, NO

(11) **Reg.nr:** 081256 **Fornyet til:** 2018.03.14
(73) **Innehaver:** Les Robinets Presto SA, 7, rue Racine, 92120, MONTROUGE, FR
(74) **Fullmektig:** Tandbergs Patentkontor AS, Postboks 1570 Vika, 0118, OSLO, NO

(11) **Reg.nr:** 081263 **Fornyet til:** 2018.03.27
(73) **Innehaver:** Louis Poulsen Lighting A/S, Gammel Strand 28, 1202, KØBENHAVN K, DK
(74) **Fullmektig:** Onsagers AS, Postboks 1813 Vika, 0123, OSLO, NO

(11) **Reg.nr:** 081264 **Fornyet til:** 2018.03.28
(73) **Innehaver:** Louis Poulsen Lighting A/S, Gammel Strand 28, 1202, KØBENHAVN K, DK
(74) **Fullmektig:** Onsagers AS, Postboks 1813 Vika, 0123, OSLO, NO

(11) **Reg.nr:** 081322 **Fornyet til:** 2018.04.10
(73) **Innehaver:** Lise's Systue, v/ A.L. Hermansen, Osloveien 290, 1440, DRØBAK, NO
Fornytelsen gjelder design nr. 1.

(11) **Reg.nr:** 081328 **Fornyet til:** 2018.04.15
(73) **Innehaver:** tesa SE, Quickbornstrasse 24, 20253, HAMBURG, DE
(74) **Fullmektig:** Zacco Norway AS, Postboks 2003 Vika, 0125, OSLO, NO

(11) **Reg.nr:** 081345 **Fornyet til:** 2018.05.28
(73) **Innehaver:** Calor, Place Ambroise Courtois, 69008, LYON, FR
(74) **Fullmektig:** Protector Intellectual Property Consultants AS, Oscarsgate 20, 0352, OSLO, NO

(11) **Reg.nr:** 081404 **Fornyet til:** 2018.03.26
(73) **Innehaver:** Friedrich Lederwaren GmbH, In der Alting 9, 90596, SCHWANSTETTEN, DE
(74) **Fullmektig:** Onsagers AS, Postboks 1813 Vika, 0123, OSLO, NO

(11) **Reg.nr:** 081411 **Fornyet til:** 2018.03.19
(73) **Innehaver:** Hansgrohe AG, Auestrasse 5-9, 77761, SCHILTACH, DE
(74) **Fullmektig:** Zacco Norway AS, Postboks 2003 Vika, 0125, OSLO, NO

(11) **Reg.nr:** 081454 **Fornyet til:** 2018.02.28
(73) **Innehaver:** so-ro AS, Markveien 56 G, 0550, OSLO, NO
Fornytelsen gjelder design nr. 1 og 4.

(11) **Reg.nr:** 081504 **Fornyet til:** 2018.03.27
(73) **Innehaver:** Louis Poulsen Lighting A/S, Gammel Strand 28, 1202, KØBENHAVN K, DK
(74) **Fullmektig:** Onsagers AS, Postboks 1813 Vika, 0123, OSLO, NO

Rettelse

I Designtidende nr. 01/13 ble det kunngjort fornyelse av designregistrering nr. 081072. Det presiseres at det er kun design nr. 1 og 4 som er fornyet.