

Norsk

# design tidende

[www.patentstyret.no](http://www.patentstyret.no)

Norsk designtidende er en publikasjon som inneholder kunngjøringer innenfor designområdet

**BESØKSADRESSE**

- ▶ Sandakerveien 64

**POSTADRESSE**

- ▶ Postboks 8160 Dep.  
0033 Oslo

**E-POST**

- ▶ [mail@patentstyret.no](mailto:mail@patentstyret.no)

**TELEFON**

- ▶ 22 38 73 00

**TELEFAKS**

- ▶ 22 38 73 01

**INFOSENTERETS TELEFONTID**

- ▶ kl. 09.00 - 15.00  
Telefon (+47) 22 38 73 33  
Telefaks (+47) 22 38 73 31

## Innholdsfortegnelse:

Registrerte design .....	3
Internasjonale designregistreringer .....	48
Overdragelser .....	129
Endringer i fullmaktsforhold .....	130
Fornyelse av registreringer .....	131
Avgjørelse i oppreisningssak .....	133

### INID-koder

I kunngjøringene er de enkelte data forsynt med koder overensstemmende med INID-kodesystemet

(INID= Internationally agreed Numbers for the Identification of Data).

- (11) Registreringsnummer
- (15) Registreringsdato
- (18) Dato som registreringen gjelder til
- (21) Søknadsnummer
- (22) Inngivelsesdato
- (24) Løpedag
- (30) Prioritetsopplysninger
- (43) Allment tilgjengelig dato
- (51) Klasse
- (54) Produkt
- (55) Avbildning(er)
- (72) Designer
- (73) Innehaver
- (74) Fullmektig

## Registrerte design

I henhold til designloven § 18 første ledd i.f. kunngjøres i dag følgende registrerte design.

Det kan fremsettes krav om at designregistreringen helt eller delvis skal oppheves, jf. designloven §§ 25 flg. og designforskriften §§ 26 flg.

Designregistreringen gjelder for den eller de periodene på fem år som søknaden er innlevert for, regnet fra søknadsdagen. Registreringen kan fornyes, jf. designloven §§ 23 og 24. Maksimal beskyttelsestid er 25 år. For reservedeler, se unntaket i designloven § 23 annet ledd.

(11)	<b>Reg.nr.:</b>	<b>083779</b>
(21)	<b>Søkn.nr.:</b>	20120139
(22)	<b>Inngitt:</b>	2012.02.22
(24)	<b>Løpedag:</b>	2012.02.22
(43)	<b>Allm. tilgj.:</b>	2012.08.22
(15)	<b>Registrert:</b>	2013.01.07
(45)	<b>Kunngjort:</b>	2013.02.04
(18)	<b>Reg. gjelder til:</b>	2017.02.22
(74)	<b>Fullmektig:</b>	Tove Kristin Gulbrandsen, c/o Odal Næringshage, 2100 SKARNES, Norge
(73)	<b>Innehaver:</b>	Marelius Produkter AS, c/o Odal Næringshage, 2100 SKARNES, Norge
(50)	<b>Anmerkninger:</b>	Designen er i farger.

### Design 1

(54)	<b>Produkt:</b>	Tilhenger med telt
(51)	<b>Klasse:</b>	12-10 21-04
(72)	<b>Designer:</b>	Steinar Hansen, Åslivegen 1, 2116 SANDER
(50)	<b>Anmerkning:</b>	Designen er i farger.
(55)	<b>Designavbildninger:</b>	



1.1



1.2



1.3



1.4



1.5



1.6

- (11) **Reg.nr.:** 083780  
(21) **Søkn.nr.:** 20120852  
(22) **Inngitt:** 2012.10.04  
(24) **Løpedag:** 2012.10.04  
(43) **Allm. tilgj.:** 2013.01.08  
(15) **Registrert:** 2013.01.08  
(45) **Kunngjort:** 2013.02.04  
(18) **Reg. gjelder til:** 2017.10.04  
(73) **Innehaver:** INGER LISE STUBBINGS, Vikstøl, 4720 HÆGELAND, Norge  
(50) **Anmerkninger:** Designen er i farger.

### Design 1

- (54) **Produkt:** Ornament  
(51) **Klasse:** 32-00  
(72) **Designer:** INGER LISE STUBBINGS, Vikstøl, 4720 HÆGELAND  
(50) **Anmerkning:** Designen er i farger.  
(55) **Designavbildninger:**



1.1

(11)	<b>Reg.nr.:</b>	<b>083781</b>
(21)	<b>Søkn.nr.:</b>	20120889
(22)	<b>Inngitt:</b>	2012.10.22
(24)	<b>Løpedag:</b>	2012.10.22
(43)	<b>Allm. tilgj.:</b>	2012.10.22
(15)	<b>Registrert:</b>	2013.01.08
(45)	<b>Kunngjort:</b>	2013.02.04
(18)	<b>Reg. gjelder til:</b>	2017.10.22
(74)	<b>Fullmektig:</b>	Zacco Norway AS, Postboks 2003 Vika, 0125 OSLO, Norge
(73)	<b>Innehaver:</b>	Master Lock Company LLC, 137 W. Forest Hill Avenue PO Box 927, US-WI53154 OAK CREEK, USA
(50)	<b>Anmerkninger:</b>	Registreringen gjelder samregistrering.

### Design 1

(54)	<b>Produkt:</b>	Del av lås
(51)	<b>Klasse:</b>	08-07
(72)	<b>Designer:</b>	Scott B Stevens, 4188 S. Kingan Avenue, WI53235 ST.FRANCIS, USA (US)
(30)	<b>Prioritet:</b>	2012.04.23, US, 29/418,857
(55)	<b>Designavbildninger:</b>	



1.1

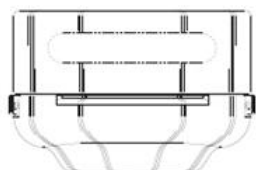

1.2



1.3



1.4



1.5

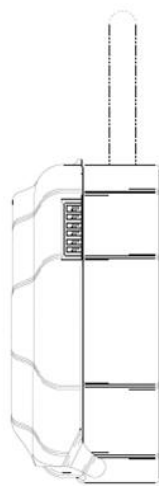

1.6



1.7

**Design 2**

- (54) **Produkt:** Del av lås
- (51) **Klasse:** 08-07
- (72) **Designer:** Scott B Stevens, 4188 S. Kingan Avenue, WI53235 ST.FRANCIS, USA (US)
- (30) **Prioritet:** 2012.04.23, US, 29/418,857
- (55) **Designavbildninger:**

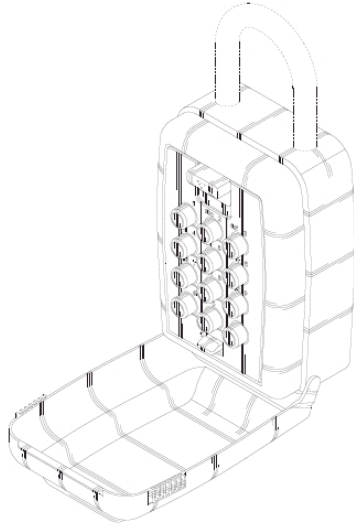

2.1



2.2

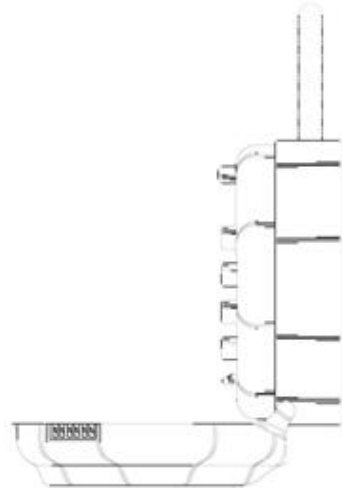

2.3



2.4

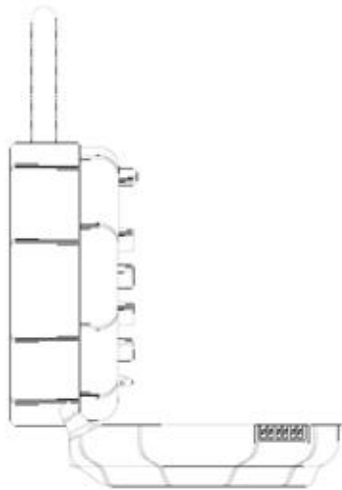

2.5

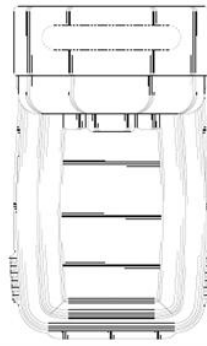

2.6

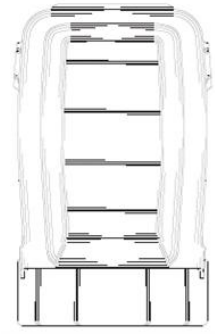

2.7

**Design 3**

(54)	<b>Produkt:</b>	Del av lås
(51)	<b>Klasse:</b>	08-07
(72)	<b>Designer:</b>	Scott B Stevens, 4188 S. Kingan Avenue, WI53235 ST.FRANCIS, USA (US)
(30)	<b>Prioritet:</b>	2012.04.23, US, 29/418,857
(55)	<b>Designavbildninger:</b>	

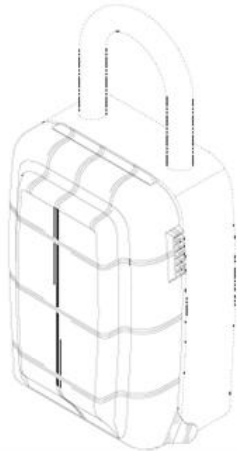

3.1

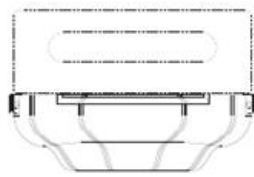

3.2

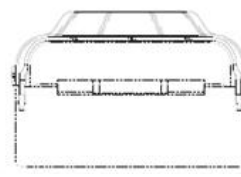

3.3



3.4

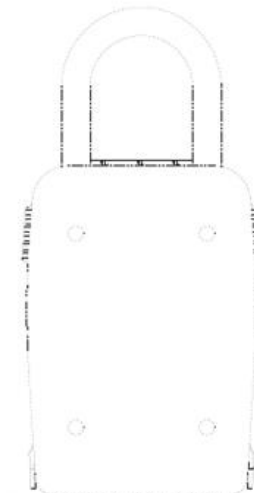

3.5

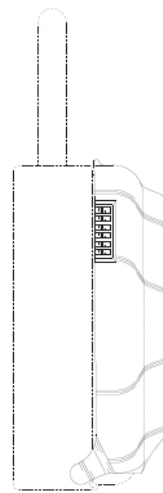

3.6

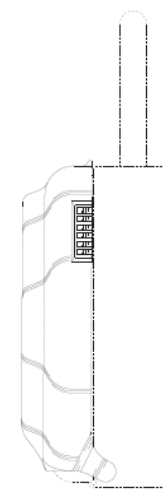

3.7

**Design 4**

(54)	<b>Produkt:</b>	Del av lås
(51)	<b>Klasse:</b>	08-07
(72)	<b>Designer:</b>	Scott B Stevens, 4188 S. Kingan Avenue, WI53235 ST.FRANCIS, USA (US)
(30)	<b>Prioritet:</b>	2012.04.23, US, 29/418,857
(55)	<b>Designavbildninger:</b>	

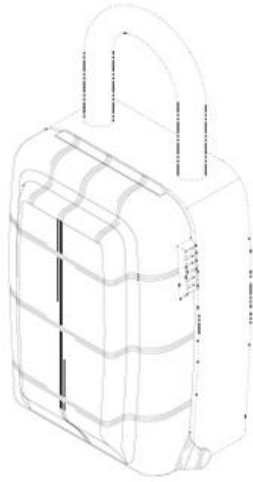

4.1

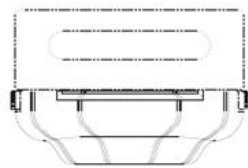

4.2

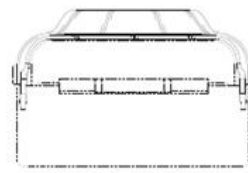

4.3



4.4

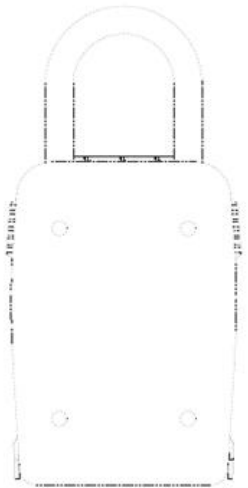

4.5

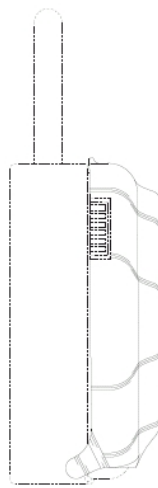

4.6

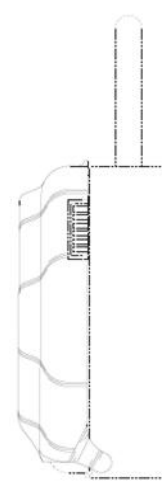

4.7



**Design 5**

(54)	<b>Produkt:</b>	Del av lås
(51)	<b>Klasse:</b>	08-07
(72)	<b>Designer:</b>	Scott B Stevens, 4188 S. Kingan Avenue, WI53235 ST.FRANCIS, USA (US)
(30)	<b>Prioritet:</b>	2012.04.23, US, 29/418,857
(55)	<b>Designavbildninger:</b>	

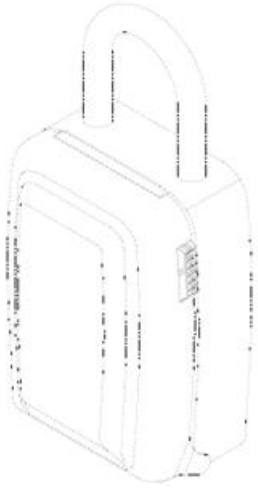

5.1

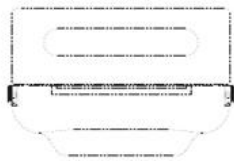

5.2

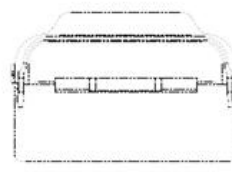

5.3

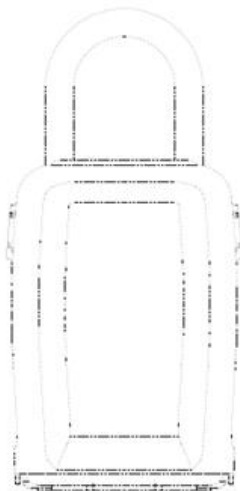

5.4

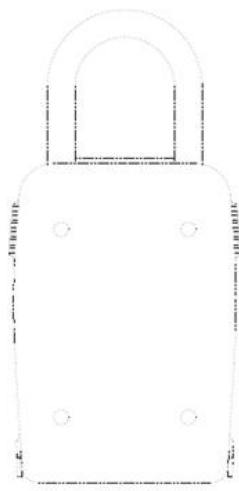

5.5

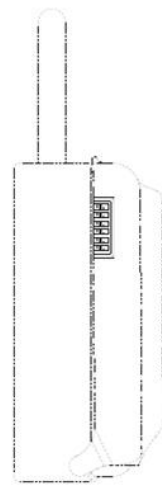

5.6

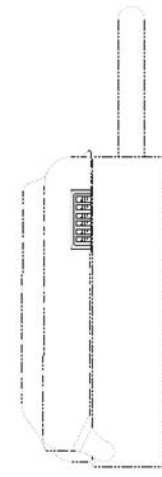

5.7

**Design 6**

(54)	<b>Produkt:</b>	Del av lås
(51)	<b>Klasse:</b>	08-07
(72)	<b>Designer:</b>	Scott B Stevens, 4188 S. Kingan Avenue, WI53235 ST.FRANCIS, USA (US)
(30)	<b>Prioritet:</b>	2012.04.23, US, 29/418,857
(55)	<b>Designavbildninger:</b>	

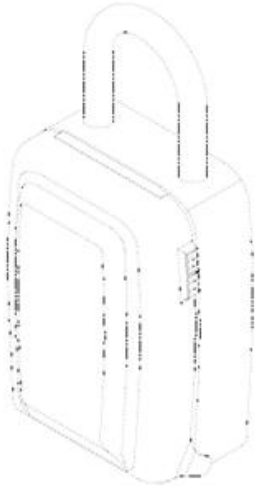

6.1

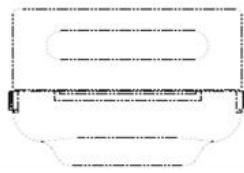

6.2

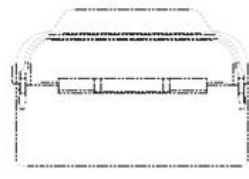

6.3

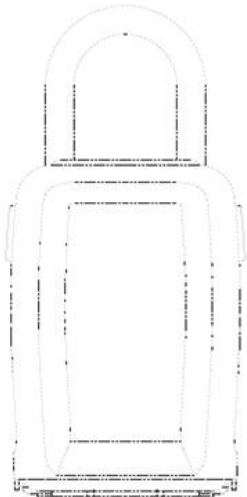

6.4

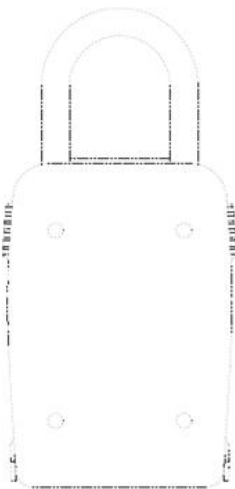

6.5

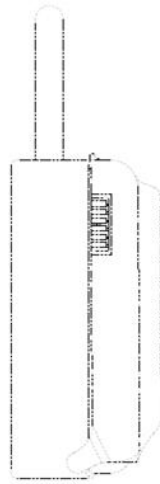

6.6



6.7

(11)	<b>Reg.nr.:</b>	<b>083782</b>
(21)	<b>Søkn.nr.:</b>	20120691
(22)	<b>Inngitt:</b>	2012.08.07
(24)	<b>Løpedag:</b>	2012.08.07
(43)	<b>Allm. tilgj.:</b>	2013.01.08
(15)	<b>Registrert:</b>	2013.01.08
(45)	<b>Kunngjort:</b>	2013.02.04
(18)	<b>Reg. gjelder til:</b>	2017.08.07
(74)	<b>Fullmektig:</b>	Protector Intellectual Property Consultants AS, Oscarsgate 20, 0352 OSLO, Norge
(73)	<b>Innehaver:</b>	Erich Krause Finland OY, Henry Fordin katu 5 N, FI-00150 HELSINGFORS, Finland
(50)	<b>Anmerkninger:</b>	Registreringen gjelder samregistrering. Det er foretatt supplerende undersøkelse.

### Design 1

(54)	<b>Produkt:</b>	Markeringspenn
(51)	<b>Klasse:</b>	19-06
(72)	<b>Designer:</b>	Beloglazov Dmitry Aleksandrovich, ul. Severnoe Chertanovo, d. 4, korp. 402, kv. 124, 113648 MOSKVA, Russland (RU)
(50)	<b>Anmerkning:</b>	Det er foretatt supplerende undersøkelse.
(55)	<b>Designavbildninger:</b>	



### Design 2

(54)	<b>Produkt:</b>	Markeringspenn
(51)	<b>Klasse:</b>	19-06
(72)	<b>Designer:</b>	Beloglazov Dmitry Aleksandrovich, ul. Severnoe Chertanovo, d. 4, korp. 402, kv. 124, 113648 MOSKVA, Russland (RU)
(50)	<b>Anmerkning:</b>	Det er foretatt supplerende undersøkelse.
(55)	<b>Designavbildninger:</b>	



- (11) **Reg.nr.:** 083783  
(21) **Søkn.nr.:** 20120306  
(22) **Inngitt:** 2012.04.04  
(24) **Løpedag:** 2012.04.04  
(43) **Allm. tilgj.:** 2012.04.04  
(15) **Registrert:** 2013.01.08  
(45) **Kunngjort:** 2013.02.04  
(18) **Reg. gjelder til:** 2017.04.04  
(73) **Innehaver:** SPORT VEST AS, Driveklepp 23, 6100 VOLDA, Norge  
(50) **Anmerkninger:** Designene er i farger.  
Registreringen gjelder samregistrering.

### Design 1

- (54) **Produkt:** Ballbinge  
(51) **Klasse:** 25-03  
(72) **Designer:** SPORT VEST AS, Driveklepp 23, 6100 VOLDA  
(50) **Anmerking:** Designen er i farger.  
(55) **Designavbildninger:**

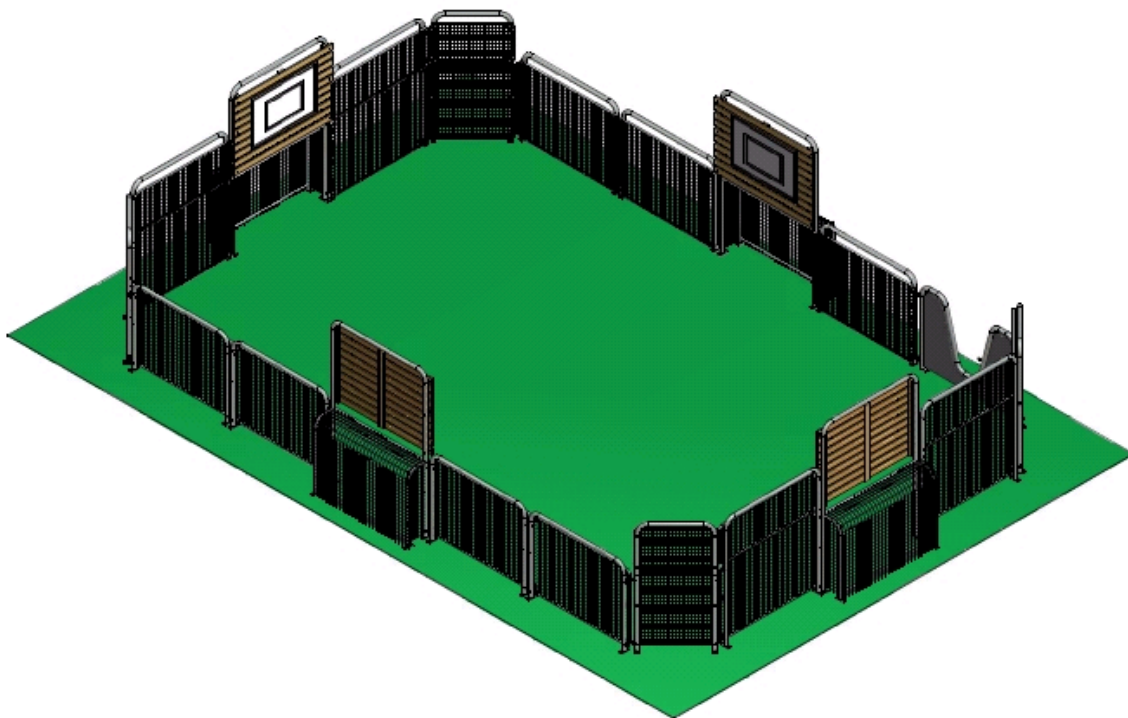

1.1

**Design 2**

(54)	<b>Produkt:</b>	Ballbinge
(51)	<b>Klasse:</b>	25-03
(72)	<b>Designer:</b>	SPORT VEST AS, Driveklepp 23, 6100 VOLDA
(50)	<b>Anmerkning:</b>	Designen er i farger.
(55)	<b>Designavbildninger:</b>	

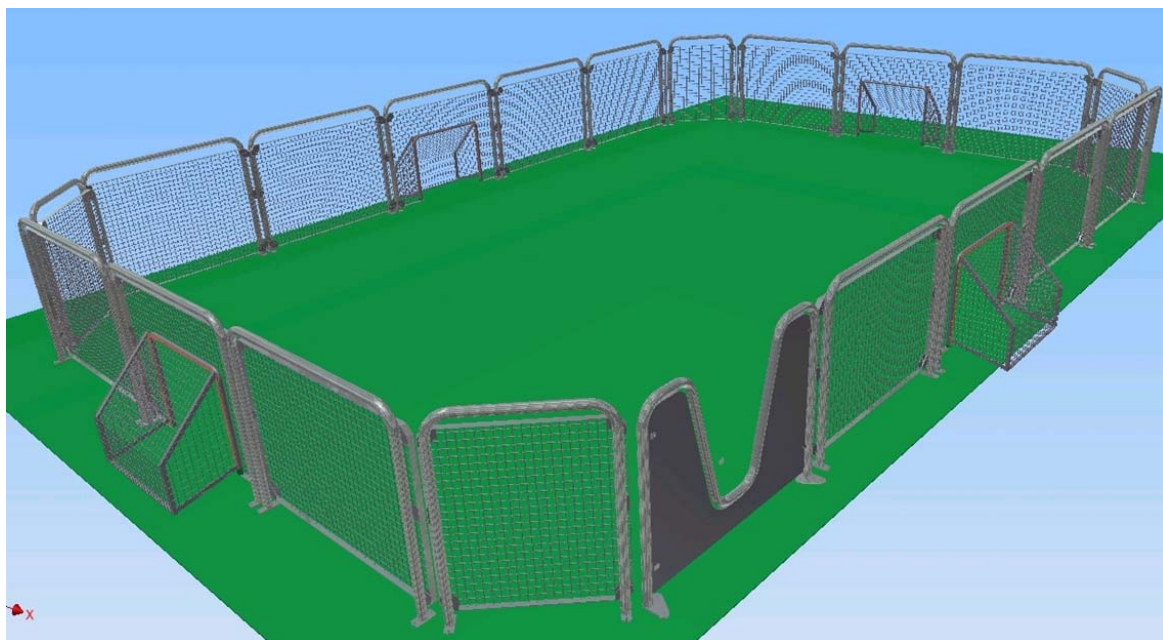

2.1

(11)	<b>Reg.nr.:</b>	<b>083784</b>
(21)	<b>Søkn.nr.:</b>	20120871
(22)	<b>Inngitt:</b>	2012.10.12
(24)	<b>Løpedag:</b>	2012.10.12
(43)	<b>Allm. tilgj.:</b>	2012.10.12
(15)	<b>Registrert:</b>	2013.01.09
(45)	<b>Kunngjort:</b>	2013.02.04
(18)	<b>Reg. gjelder til:</b>	2017.10.12
(74)	<b>Fullmektig:</b>	Zacco Norway AS, Postboks 2003 Vika, 0125 OSLO, Norge
(73)	<b>Innehaver:</b>	Master Lock Company LLC, 137 W. Forest Hill Avenue PO Box 927, US-WI53154 OAK CREEK, USA
(50)	<b>Anmerkninger:</b>	Registreringen gjelder samregistrering.

**Design 1**

(54)	<b>Produkt:</b>	Lås
(51)	<b>Klasse:</b>	08-07
(72)	<b>Designer:</b>	Scott B Stevens, 4188 S. Kingan Avenue, WI53235 ST.FRANCIS, USA (US)
(30)	<b>Prioritet:</b>	2012.04.12, US, 29/418,076
(55)	<b>Designavbildninger:</b>	

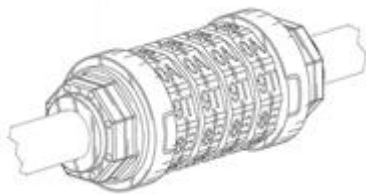

1.1



1.2

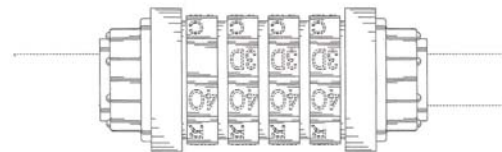

1.3

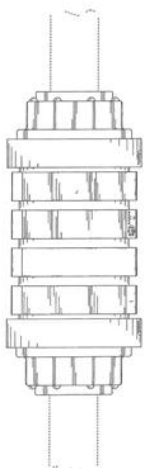

1.4

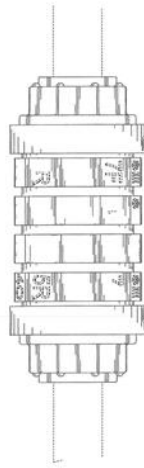

1.5

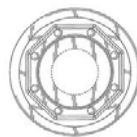

1.6

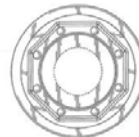

1.7

**Design 2**

- (54) **Produkt:** Lås
- (51) **Klasse:** 08-07
- (72) **Designer:** Scott B Stevens, 4188 S. Kingan Avenue, WI53235 ST.FRANCIS, USA (US)
- (30) **Prioritet:** 2012.04.12, US, 29/418,076
- (55) **Designavbildninger:**



2.1

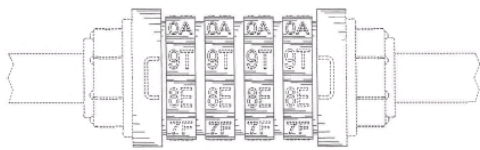

2.2

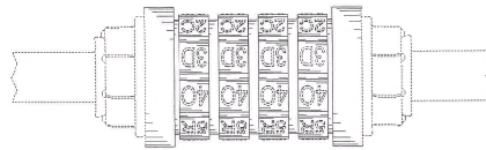

2.3

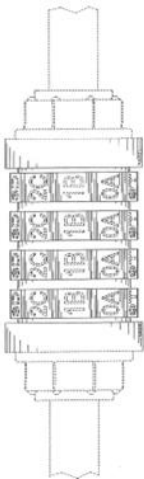

2.4

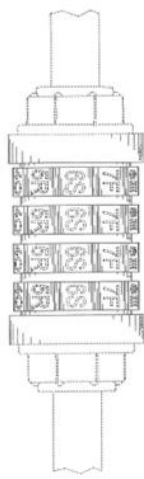

2.5

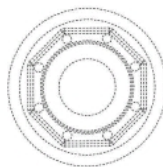

2.6

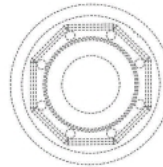

2.7

**Design 3**

- (54) **Produkt:** Lås
- (51) **Klasse:** 08-07
- (72) **Designer:** Scott B Stevens, 4188 S. Kingan Avenue, WI53235 ST.FRANCIS, USA (US)
- (30) **Prioritet:** 2012.04.12, US, 29/418,076
- (55) **Designavbildninger:**



3.1

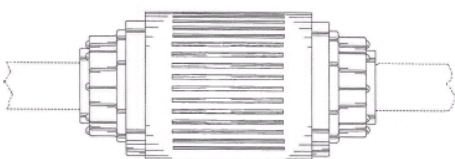

3.2

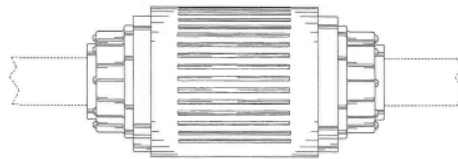

3.3



3.4



3.5

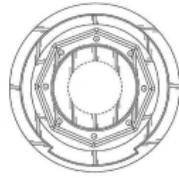

3.6

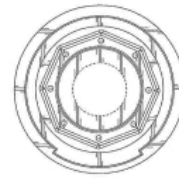

3.7

**Design 4**

- (54) **Produkt:** Lås
- (51) **Klasse:** 08-07
- (72) **Designer:** Scott B Stevens, 4188 S. Kingan Avenue, WI53235 ST.FRANCIS, USA (US)
- (30) **Prioritet:** 2012.04.12, US, 29/418,076
- (55) **Designavbildninger:**

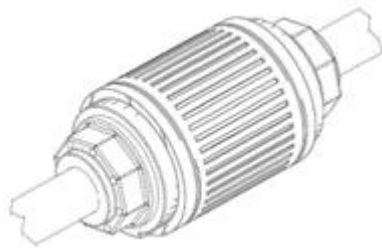

4.1



4.2



4.3



4.4



4.5

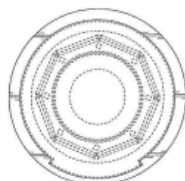

4.6

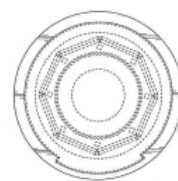

4.7



**Design 5**

- (54) **Produkt:** Lås
- (51) **Klasse:** 08-07
- (72) **Designer:** Scott B Stevens, 4188 S. Kingan Avenue, WI53235 ST.FRANCIS, USA (US)
- (30) **Prioritet:** 2012.04.12, US, 29/418,076
- (55) **Designavbildninger:**

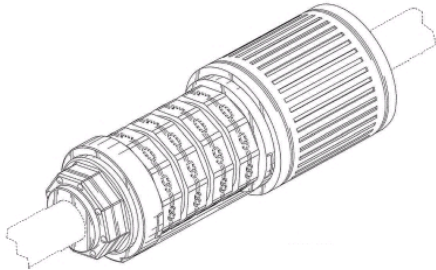

5.1

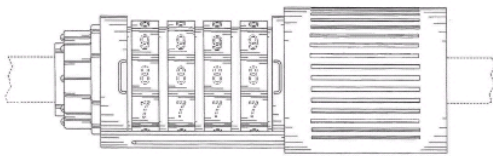

5.2

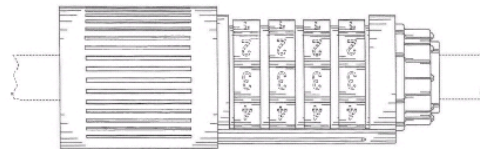

5.3

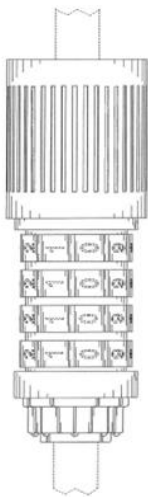

5.4

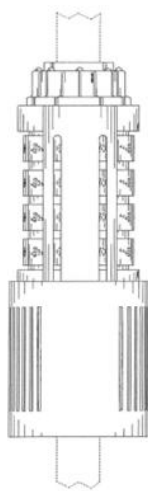

5.5

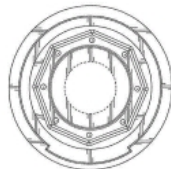

5.6



5.7

**Design 6**

- (54) **Produkt:** Lås
- (51) **Klasse:** 08-07
- (72) **Designer:** Scott B Stevens, 4188 S. Kingan Avenue, WI53235 ST.FRANCIS, USA (US)
- (30) **Prioritet:** 2012.04.12, US, 29/418,076
- (55) **Designavbildninger:**

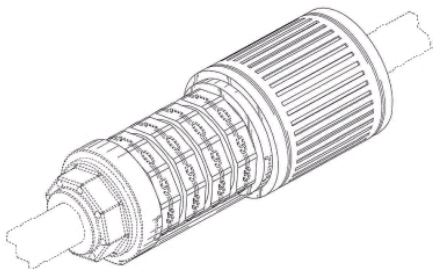

6.1

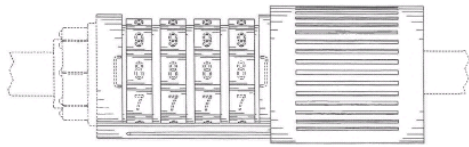

6.2

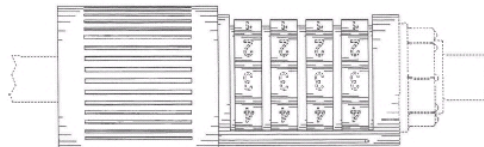

6.3

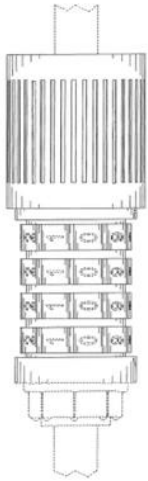

6.4

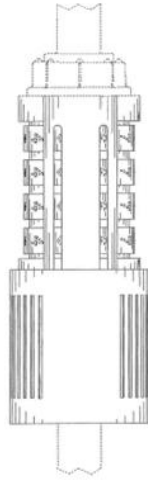

6.5

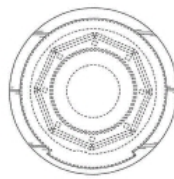

6.6

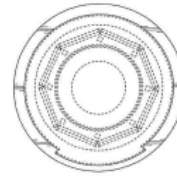

6.7

**Design 7**

- (54) **Produkt:** Lås
- (51) **Klasse:** 08-07
- (72) **Designer:** Scott B Stevens, 4188 S. Kingan Avenue, WI53235 ST.FRANCIS, USA (US)
- (30) **Prioritet:** 2012.04.12, US, 29/418,076
- (55) **Designavbildninger:**

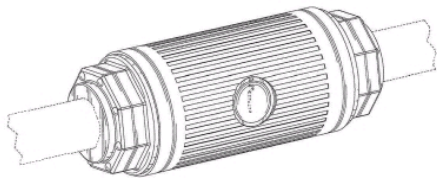

7.1

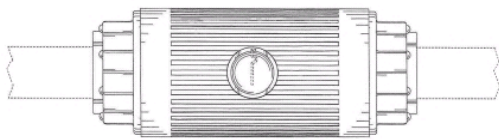

7.2



7.3



7.4

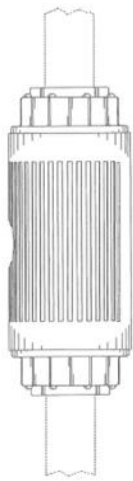

7.5

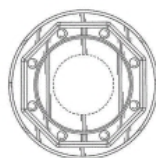

7.6

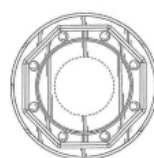

7.7

**Design 8**

(54)	<b>Produkt:</b>	Lås
(51)	<b>Klasse:</b>	08-07
(72)	<b>Designer:</b>	Scott B Stevens, 4188 S. Kingan Avenue, WI53235 ST.FRANCIS, USA (US)
(30)	<b>Prioritet:</b>	2012.04.12, US, 29/418,076
(55)	<b>Designavbildninger:</b>	

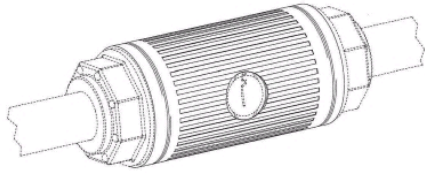

8.1

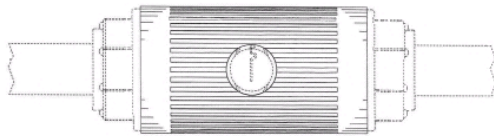

8.2

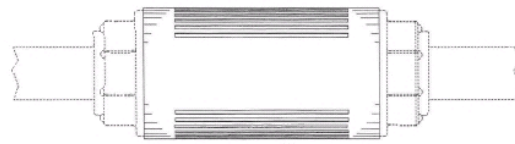

8.3

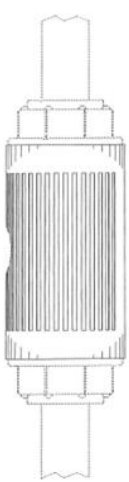

8.4



8.5

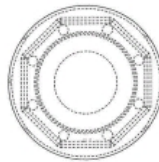

8.6

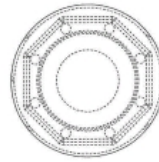

8.7

(11)	<b>Reg.nr.:</b>	<b>083785</b>
(21)	<b>Søkn.nr.:</b>	20120874
(22)	<b>Inngitt:</b>	2012.10.12
(24)	<b>Løpedag:</b>	2012.10.12
(43)	<b>Allm. tilgj.:</b>	2012.10.12
(15)	<b>Registrert:</b>	2013.01.09
(45)	<b>Kunngjort:</b>	2013.02.04
(18)	<b>Reg. gjelder til:</b>	2017.10.12
(74)	<b>Fullmektig:</b>	Zacco Norway AS, Postboks 2003 Vika, 0125 OSLO, Norge
(73)	<b>Innehaver:</b>	Mass Technology (HK) Ltd, 31/F., Two Landmark East, 100 How Ming Street, CN- KWUN TONG, KOWLOON, Kina

**Design 1**

(54)	<b>Produkt:</b>	Lyspære
(51)	<b>Klasse:</b>	26-04
(72)	<b>Designer:</b>	Onn Fah Foo, 31/F., Two Landmark East 100 How Ming Street KWUN TONG, KOWLOON, Kina (CN)
(30)	<b>Prioritet:</b>	2012.04.14, CN, 1200696.9M004
(55)	<b>Designavbildninger:</b>	

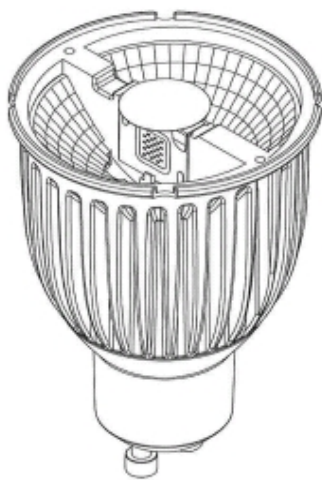

1.1

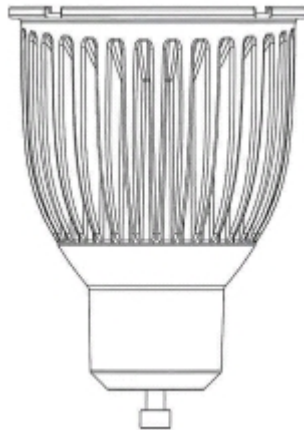

1.2

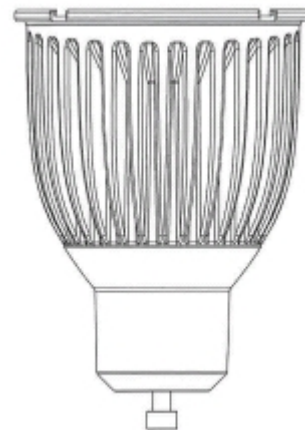

1.3



1.4

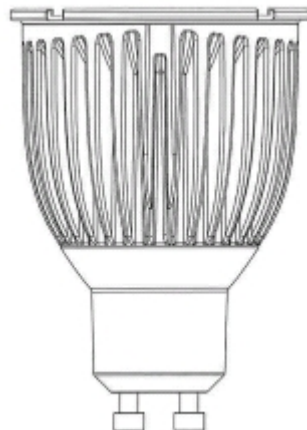

1.5

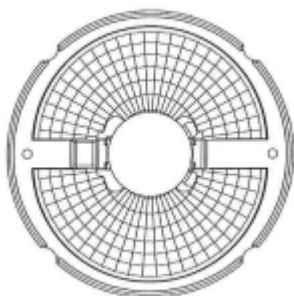

1.6

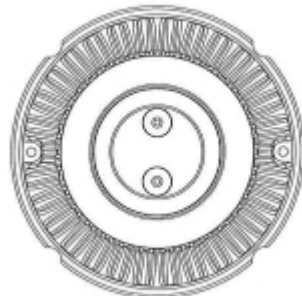

1.7

- (11) **Reg.nr.:** 083786  
(21) **Søkn.nr.:** 20120779  
(22) **Inngitt:** 2012.09.07  
(24) **Løpedag:** 2012.09.07  
(43) **Allm. tilgj.:** 2012.09.07  
(15) **Registrert:** 2013.01.09  
(45) **Kunngjort:** 2013.02.04  
(18) **Reg. gjelder til:** 2017.09.07  
(74) **Fullmektig:** Acapo AS, Postboks 1880 Nordnes, 5817 BERGEN, Norge  
(73) **Innehaver:** Akriform Plast AB, Kuskvägen 9, SE-19162 SOLLENTUNA, Sverige  
(50) **Anmerkninger:** Registreringen gjelder samregistrering.

### Design 1

- (54) **Produkt:** Utstillingsbeholder og dispenser for spiselige produkter  
(51) **Klasse:** 20-02  
(72) **Designner:** Patrik Gille, c/o Akriform Plast AB, Kuskvägen 9, 19162 SOLLENTUNA, Sverige (SE)  
Claes Engström, c/o Akriform Plast AB, Kuskvägen 9, 19162 SOLLENTUNA, Sverige (SE)  
(55) **Designavbildninger:**

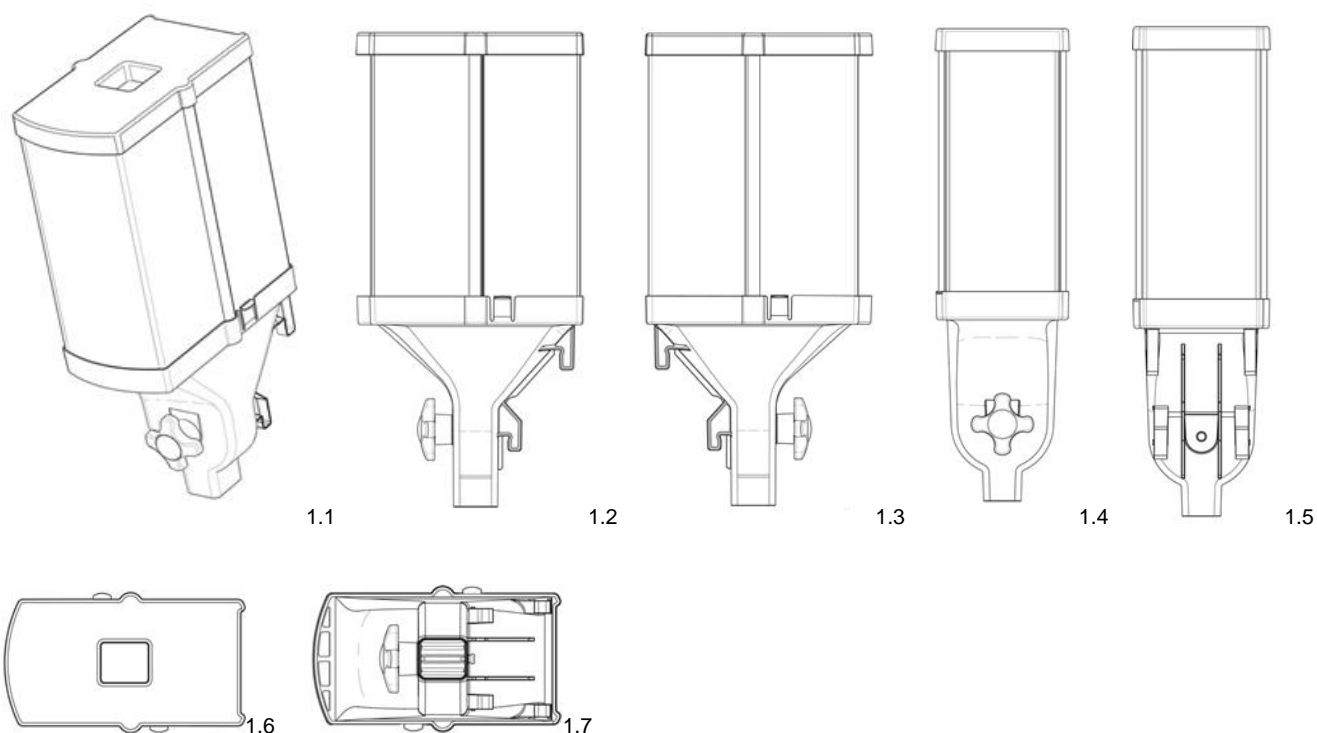

**Design 2**

- (54) **Produkt:** Del til utstillingsbeholder og dispenser for spiselige produkter  
(51) **Klasse:** 20-02  
(72) **Designer:** Patrik Gille, c/o Akriform Plast AB, Kuskvägen 9, 19162 SOLLENTUNA, Sverige (SE)  
Claes Engström, c/o Akriform Plast AB, Kuskvägen 9, 19162 SOLLENTUNA, Sverige (SE)  
(55) **Designavbildninger:**

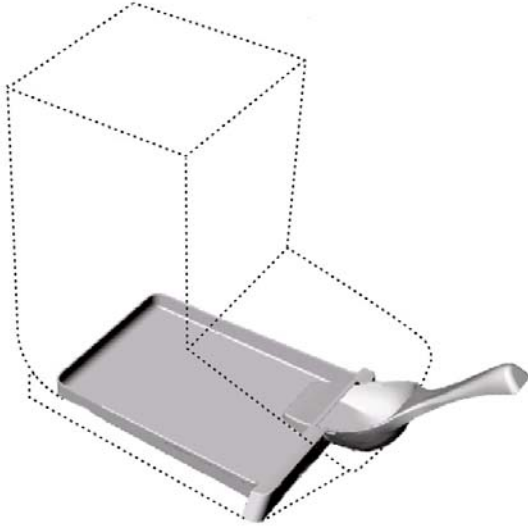

2.1

**Design 3**

- (54) **Produkt:** Del til utstillingsbeholder og dispenser for spiselige produkter  
(51) **Klasse:** 20-02  
(72) **Designer:** Patrik Gille, c/o Akriform Plast AB, Kuskvägen 9, 19162 SOLLENTUNA, Sverige (SE)  
Claes Engström, c/o Akriform Plast AB, Kuskvägen 9, 19162 SOLLENTUNA, Sverige (SE)  
(55) **Designavbildninger:**

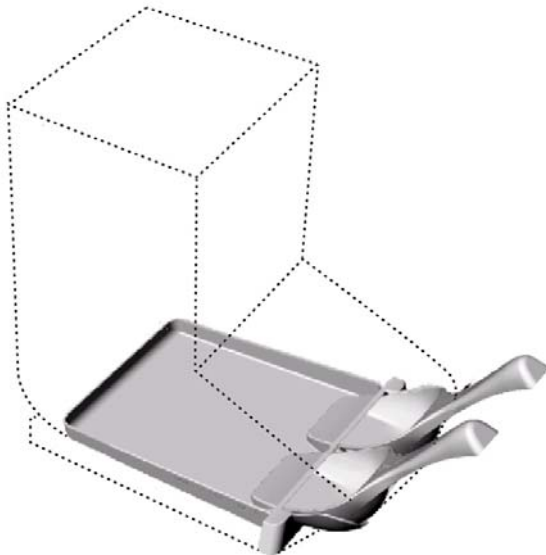

3.1

- (11) **Reg.nr.:** 083787  
 (21) **Søkn.nr.:** 20120881  
 (22) **Inngitt:** 2012.10.16  
 (24) **Løpedag:** 2012.10.16  
 (43) **Allm. tilgj.:** 2012.10.16  
 (15) **Registrert:** 2013.01.10  
 (45) **Kunngjort:** 2013.02.04  
 (18) **Reg. gjelder til:** 2017.10.16  
 (73) **Innehaber:** Vigdis Antonie Olaussen, Sorgenfrigt. 38B, 0365 OSLO, Norge  
 (50) **Anmerkninger:** Designen er i farger.

**Design 1**

- (54) **Produkt:** Kombinert kalender og notathefte  
 (51) **Klasse:** 19-03  
 19-04  
 (72) **Designer:** Vigdis Antonie Olaussen, Sorgenfrigt. 38B, 0365 OSLO  
 (50) **Anmerkning:** Designen er i farger.  
 (55) **Designavbildninger:**



1.1



1.2

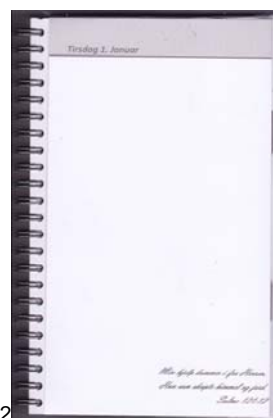

1.3

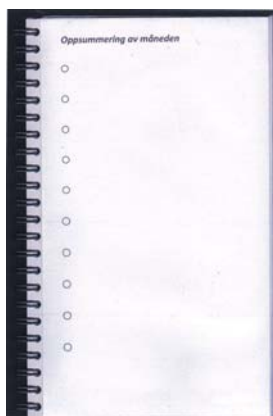

1.4



1.5



1.6



1.7



1.8



1.9



1.10



1.11



1.12



1.13



1.14



1.15



1.16



1.17

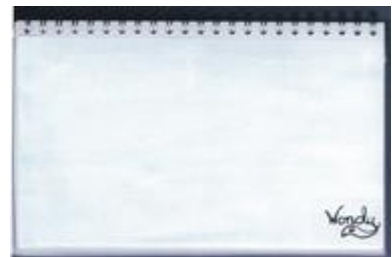

1.18



- (11) **Reg.nr.:** 083788  
 (21) **Søkn.nr.:** 20120891  
 (22) **Inngitt:** 2012.10.17  
 (24) **Løpedag:** 2012.10.17  
 (43) **Allm. tilgj.:** 2013.01.10  
 (15) **Registrert:** 2013.01.10  
 (45) **Kunngjort:** 2013.02.04  
 (18) **Reg. gjelder til:** 2017.10.17  
 (74) **Fullmektig:** ip.coop (IPR SA), c/o Leogriff AS, Bygdøy Allé 4 , 0257 OSLO, Norge  
 (73) **Innehaver:** AS Wilfa, Postboks 146, 1483 SKYTSTA, Norge  
 (50) **Anmerkninger:** Designene er i farger.  
 Registreringen gjelder samregistrering.

**Design 1**

- (54) **Produkt:** Kaffetrakter  
 (51) **Klasse:** 07-02  
 (72) **Designer:** Arild Jørgensen, Ellingsrudveien 8A, 1089 OSLO  
 (50) **Anmerkning:** Designen er i farger.  
 (55) **Designavbildninger:**



1.1



1.2

**Design 2**

- (54) **Produkt:** Kaffetrakter  
 (51) **Klasse:** 07-02  
 (72) **Designer:** Arild Jørgensen, Ellingsrudveien 8A, 1089 OSLO  
 (50) **Anmerkning:** Designen er i farger.  
 (55) **Designavbildninger:**



2.1



2.2

**Design 3**

(54)	<b>Produkt:</b>	Vannbeholder
(51)	<b>Klasse:</b>	07-02
(72)	<b>Designer:</b>	Arild Jørgensen, Ellingsrudveien 8A, 1089 OSLO
(50)	<b>Anmerkning:</b>	Designen er i farger.
(55)	<b>Designavbildninger:</b>	

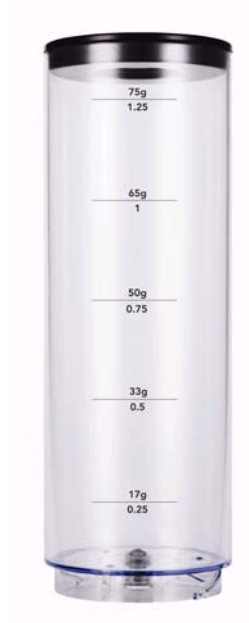

3.1

(11)	<b>Reg.nr.:</b>	<b>083789</b>
(21)	<b>Søkn.nr.:</b>	20120794
(22)	<b>Inngitt:</b>	2012.09.12
(24)	<b>Løpedag:</b>	2012.09.12
(43)	<b>Allm. tilgj.:</b>	2013.01.11
(15)	<b>Registrert:</b>	2013.01.11
(45)	<b>Kunngjort:</b>	2013.02.04
(18)	<b>Reg. gjelder til:</b>	2017.09.12
(74)	<b>Fullmektig:</b>	Protector Intellectual Property Consultants AS, Oscarsgate 20, 0352 OSLO, Norge
(73)	<b>Innehaver:</b>	Berendsen A/S, Edvard Thomsens Vej 14, 7th Orestad City, DK-2300 COPENHAGEN, Danmark
(50)	<b>Anmerkninger:</b>	Designene er i farger. Registreringen gjelder samregistrering.

### Design 1

(54)	<b>Produkt:</b>	Tekstilstoff
(51)	<b>Klasse:</b>	05-05
(72)	<b>Designer:</b>	Krestine Kjærholm, Holgersvej 3, 2920 CHARLOTTENLUND, Danmark (DK)
(30)	<b>Prioritet:</b>	2012.08.31, EM, 002095786
(50)	<b>Anmerkning:</b>	Designen er i farger.
(55)	<b>Designavbildninger:</b>	

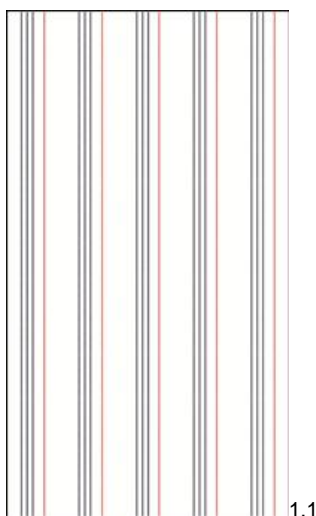

### Design 2

(54)	<b>Produkt:</b>	Tekstilstoff
(51)	<b>Klasse:</b>	05-05
(72)	<b>Designer:</b>	Krestine Kjærholm, Holgersvej 3, 2920 CHARLOTTENLUND, Danmark (DK)
(30)	<b>Prioritet:</b>	2012.08.31, EM, 002095786
(50)	<b>Anmerkning:</b>	Designen er i farger.
(55)	<b>Designavbildninger:</b>	

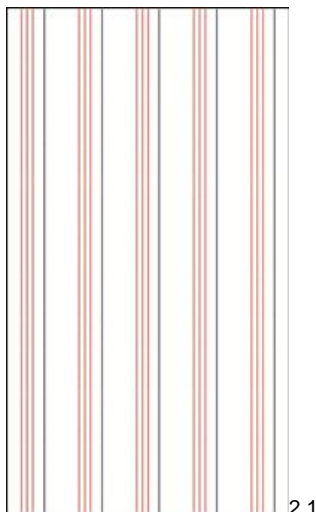

**Design 3**

- (54) **Produkt:** Tekstilstoff  
(51) **Klasse:** 05-05  
(72) **Designer:** Krestine Kjærholm, Holgersvej 3, 2920 CHARLOTTENLUND, Danmark (DK)  
(30) **Prioritet:** 2012.08.31, EM, 002095786  
(50) **Anmerkning:** Designen er i farger.  
(55) **Designavbildninger:**

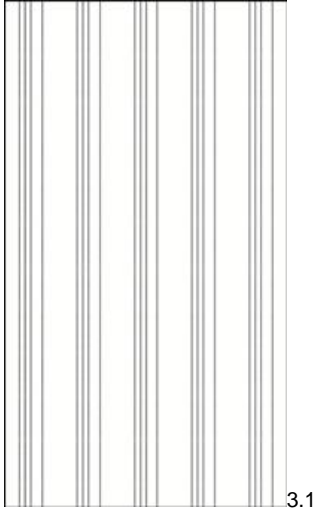
**Design 4**

- (54) **Produkt:** Tekstilstoff  
(51) **Klasse:** 05-05  
(72) **Designer:** Krestine Kjærholm, Holgersvej 3, 2920 CHARLOTTENLUND, Danmark (DK)  
(30) **Prioritet:** 2012.08.31, EM, 002095786  
(50) **Anmerkning:** Designen er i farger.  
(55) **Designavbildninger:**

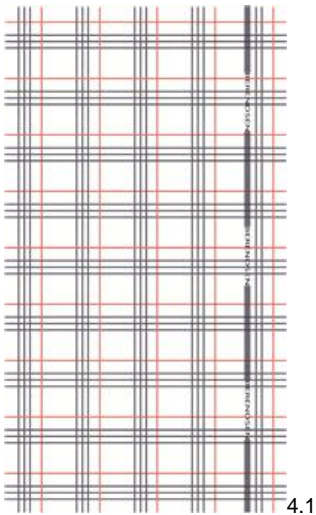

**Design 5**

(54)	<b>Produkt:</b>	Tekstilstoff
(51)	<b>Klasse:</b>	05-05
(72)	<b>Designer:</b>	Krestine Kjærholm, Holgersvej 3, 2920 CHARLOTTENLUND, Danmark (DK)
(30)	<b>Prioritet:</b>	2012.08.31, EM, 002095786
(50)	<b>Anmerkning:</b>	Designen er i farger.
(55)	<b>Designavbildninger:</b>	

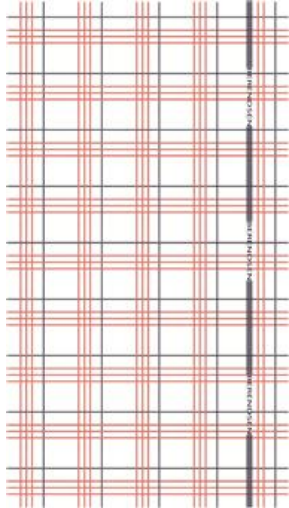

5.1

**Design 6**

(54)	<b>Produkt:</b>	Tekstilstoff
(51)	<b>Klasse:</b>	05-05
(72)	<b>Designer:</b>	Krestine Kjærholm, Holgersvej 3, 2920 CHARLOTTENLUND, Danmark (DK)
(30)	<b>Prioritet:</b>	2012.08.31, EM, 002095786
(50)	<b>Anmerkning:</b>	Designen er i farger.
(55)	<b>Designavbildninger:</b>	

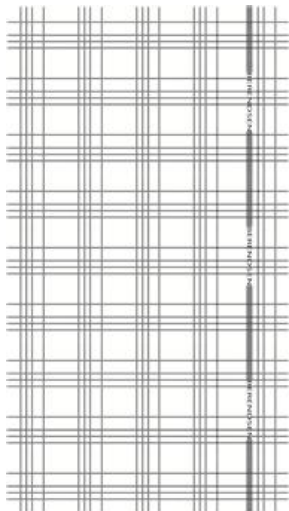

6.1

**Design 7**

(54)	<b>Produkt:</b>	Tekstilstoff
(51)	<b>Klasse:</b>	05-05
(72)	<b>Designer:</b>	Krestine Kjærholm, Holgersvej 3, 2920 CHARLOTTENLUND, Danmark (DK)
(30)	<b>Prioritet:</b>	2012.08.31, EM, 002095786
(50)	<b>Anmerkning:</b>	Designen er i farger.
(55)	<b>Designavbildninger:</b>	

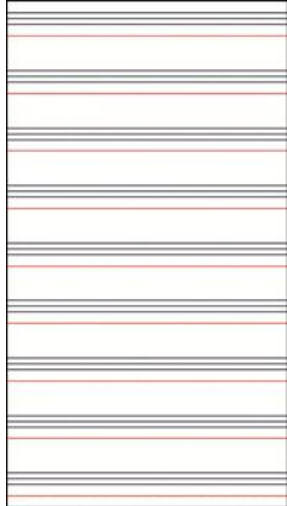

7.1

**Design 8**

(54)	<b>Produkt:</b>	Tekstilstoff
(51)	<b>Klasse:</b>	05-05
(72)	<b>Designer:</b>	Krestine Kjærholm, Holgersvej 3, 2920 CHARLOTTENLUND, Danmark (DK)
(30)	<b>Prioritet:</b>	2012.08.31, EM, 002095786
(50)	<b>Anmerkning:</b>	Designen er i farger.
(55)	<b>Designavbildninger:</b>	

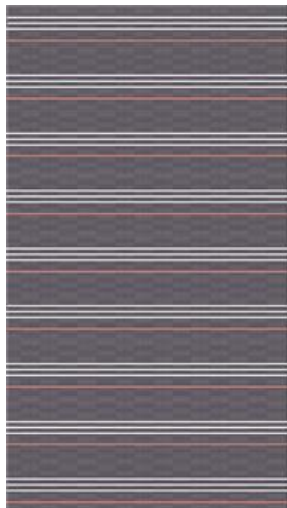

8.1

**Design 9**

- (54) **Produkt:** Tekstilstoff  
(51) **Klasse:** 05-05  
(72) **Designer:** Krestine Kjærholm, Holgersvej 3, 2920 CHARLOTTENLUND, Danmark (DK)  
(30) **Prioritet:** 2012.08.31, EM, 002095786  
(50) **Anmerkning:** Designen er i farger.  
(55) **Designavbildninger:**

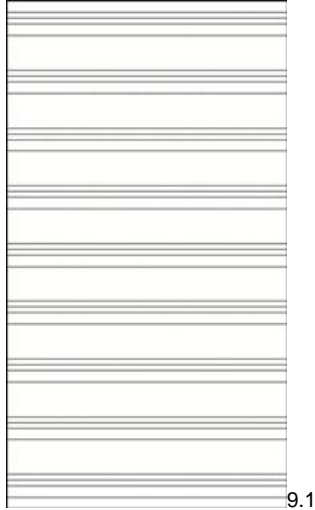
**Design 10**

- (54) **Produkt:** Tekstilstoff  
(51) **Klasse:** 05-05  
(72) **Designer:** Krestine Kjærholm, Holgersvej 3, 2920 CHARLOTTENLUND, Danmark (DK)  
(30) **Prioritet:** 2012.08.31, EM, 002095786  
(50) **Anmerkning:** Designen er i farger.  
(55) **Designavbildninger:**

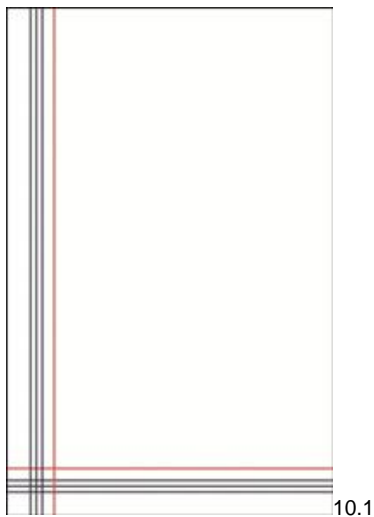

**Design 11**

- (54) **Produkt:** Tekstilstoff  
(51) **Klasse:** 05-05  
(72) **Designer:** Krestine Kjærholm, Holgersvej 3, 2920 CHARLOTTENLUND, Danmark (DK)  
(30) **Prioritet:** 2012.08.31, EM, 002095786  
(50) **Anmerkning:** Designen er i farger.  
(55) **Designavbildninger:**

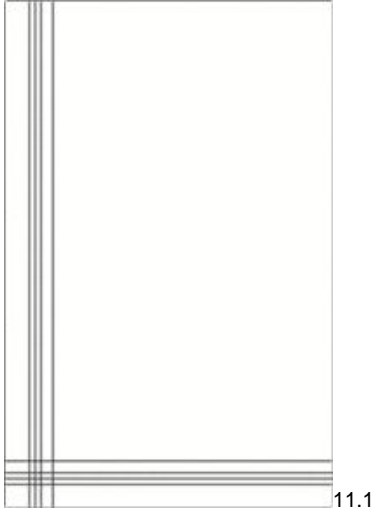
**Design 12**

- (54) **Produkt:** Tekstilstoff  
(51) **Klasse:** 05-05  
(72) **Designer:** Krestine Kjærholm, Holgersvej 3, 2920 CHARLOTTENLUND, Danmark (DK)  
(30) **Prioritet:** 2012.08.31, EM, 002095786  
(50) **Anmerkning:** Designen er i farger.  
(55) **Designavbildninger:**





**Design 13**

- (54) **Produkt:** Tekstilstoff  
(51) **Klasse:** 05-05  
(72) **Designer:** Krestine Kjærholm, Holgersvej 3, 2920 CHARLOTTENLUND, Danmark (DK)  
(30) **Prioritet:** 2012.08.31, EM, 002095786  
(50) **Anmerkning:** Designen er i farger.  
(55) **Designavbildninger:**



13.1

- (11) **Reg.nr.:** 083790  
(21) **Søkn.nr.:** 20120870  
(22) **Inngitt:** 2012.10.12  
(24) **Løpedag:** 2012.10.12  
(43) **Allm. tilgj.:** 2012.10.12  
(15) **Registrert:** 2013.01.11  
(45) **Kunngjort:** 2013.02.04  
(18) **Reg. gjelder til:** 2017.10.12  
(73) **Innehaver:** ANNE FRØYDIS LINNERUD SIV ARK MNAL, Gråbrødreveien 17, 0379 OSLO, Norge  
(50) **Anmerkninger:** Designen er i farger.

**Design 1**

- (54) **Produkt:** Kile/bolt for å feste to elementer sammen  
(51) **Klasse:** 08-08  
(72) **Designer:** Christine Petersen, Gråbrødreveien 17, 0379 OSLO  
Anne Frøydis Linnerud, Gråbrødreveien 17, 0379 OSLO  
(50) **Anmerkning:** Designen er i farger.  
(55) **Designavbildninger:**



1.1

- (11) **Reg.nr.:** 083791  
(21) **Søkn.nr.:** 20120868  
(22) **Inngitt:** 2012.10.11  
(24) **Løpedag:** 2012.10.11  
(43) **Allm. tilgj.:** 2012.10.11  
(15) **Registrert:** 2013.01.11  
(45) **Kunngjort:** 2013.02.04  
(18) **Reg. gjelder til:** 2017.10.11  
(74) **Fullmektig:** Zacco Norway AS, Postboks 2003 Vika, 0125 OSLO, Norge  
(73) **Innehaver:** Zurreball AS, Pilestredet 29, 0166 OSLO, Norge  
(50) **Anmerkninger:** Registreringen gjelder samregistrering.

### Design 1

- (54) **Produkt:** Foliekutter  
(51) **Klasse:** 07-99  
(72) **Designer:** Line Bogen, c/o Zurreball AS, Pilestredet 29, 0166 OSLO  
Petter Bogen, Pilestredet 29, 0166 OSLO  
(55) **Designavbildninger:**



1.1



1.2

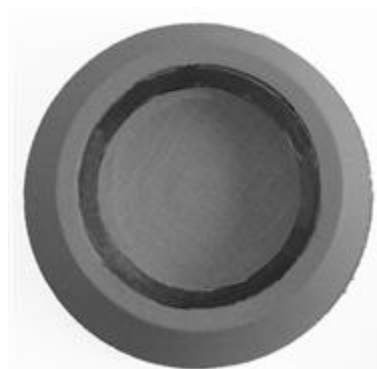

1.3



1.4



1.5

### Design 2

- (54) **Produkt:** Kniv til foliekutter  
(51) **Klasse:** 07-99  
(72) **Designer:** Line Bogen, c/o Zurreball AS, Pilestredet 29, 0166 OSLO  
Petter Bogen, Pilestredet 29, 0166 OSLO  
(55) **Designavbildninger:**



2.1



2.2

(11)	<b>Reg.nr.:</b>	<b>083792</b>
(21)	<b>Søkn.nr.:</b>	20120964
(22)	<b>Inngitt:</b>	2012.11.16
(24)	<b>Løpedag:</b>	2012.11.16
(43)	<b>Allm. tilgj.:</b>	2013.01.11
(15)	<b>Registrert:</b>	2013.01.11
(45)	<b>Kunngjort:</b>	2013.02.04
(18)	<b>Reg. gjelder til:</b>	2017.11.16
(74)	<b>Fullmektig:</b>	Curo AS, Industriveien 53, 7080 HEIMDAL, Norge
(73)	<b>Innehaver:</b>	Fenix Outdoor AB, Box 209, SE-89125 ÖRNSKÖLDSVIK, Sverige

**Design 1**

(54)	<b>Produkt:</b>	Kjele
(51)	<b>Klasse:</b>	07-02
(72)	<b>Designer:</b>	Niklas Andersson, Kärhovsgatan 22, 11621 STOCKHOLM, Sverige (SE)
(30)	<b>Prioritet:</b>	2012.10.11, EM, 002117333
(55)	<b>Designavbildninger:</b>	

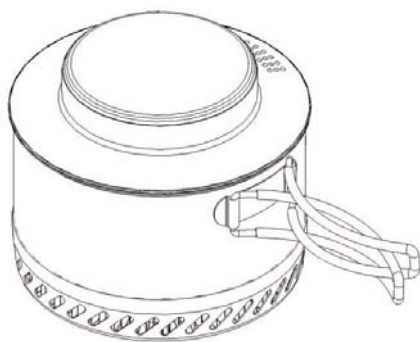

1.1

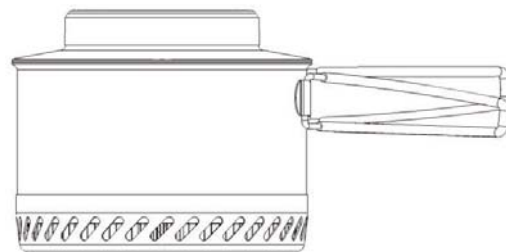

1.2

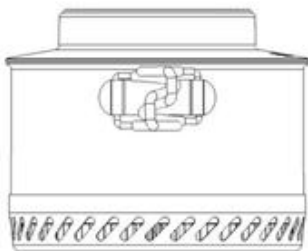

1.3

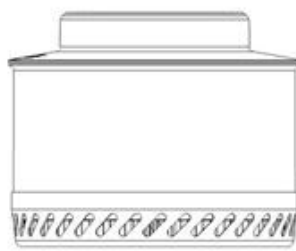

1.4

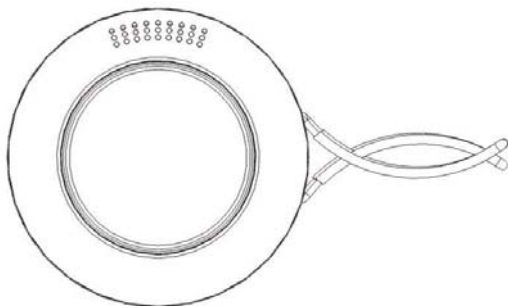

1.5

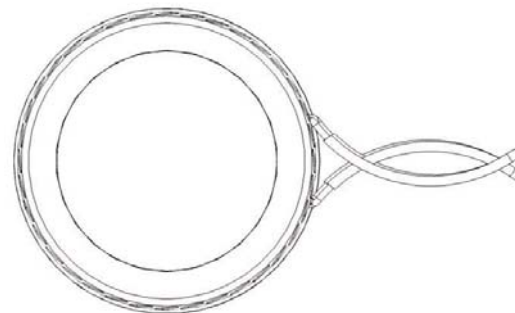

1.6

(11)	<b>Reg.nr.:</b>	<b>083793</b>
(21)	<b>Søkn.nr.:</b>	20120785
(22)	<b>Inngitt:</b>	2012.09.18
(24)	<b>Løpedag:</b>	2012.09.18
(43)	<b>Allm. tilgj.:</b>	2012.11.23
(15)	<b>Registrert:</b>	2013.01.16
(45)	<b>Kunngjort:</b>	2013.02.04
(18)	<b>Reg. gjelder til:</b>	2017.09.18
(74)	<b>Fullmektig:</b>	Bryn Aarflot AS, Postboks 449 Sentrum, 0104 OSLO, Norge
(73)	<b>Innehaber:</b>	Tomil sro, Gen. Svatone 149/IV, CZ-56601 VYSOKÉ MÝTO, Den tsjekkiske republikk

### Design 1

(54)	<b>Produkt:</b>	Flaske
(51)	<b>Klasse:</b>	09-01
(72)	<b>Designer:</b>	Tomas Muller, Zamecek 443/8, 50008 HRADEC KRALOVE, Den tsjekkiske republikk (CZ)
(30)	<b>Prioritet:</b>	2012.05.23, EM, 0020454842
(55)	<b>Designavbildninger:</b>	



1.1



1.2



1.3

(11)	<b>Reg.nr.:</b>	<b>083794</b>
(21)	<b>Søkn.nr.:</b>	20120945
(22)	<b>Inngitt:</b>	2012.11.01
(24)	<b>Løpedag:</b>	2012.11.01
(43)	<b>Allm. tilgj.:</b>	2012.11.15
(15)	<b>Registrert:</b>	2013.01.16
(45)	<b>Kunngjort:</b>	2013.02.04
(18)	<b>Reg. gjelder til:</b>	2017.11.01
(74)	<b>Fullmektig:</b>	Onsagers AS, Postboks 1813 Vika, 0123 OSLO, Norge
(73)	<b>Innehaver:</b>	WELLSTAT DIAGNOSTICS LLC, 930 Clopper Road, US-MD20878 GAITHERSBURG, USA

**Design 1**

(54)	<b>Produkt:</b>	Databehandlingsutstyr, klasse 14-02/diagnostisk instrument, klasse 24-01
(51)	<b>Klasse:</b>	14-02 24-01
(72)	<b>Designer:</b>	Richard Cook, 6912 Tennyson Road, MD20855 DERWOOD, USA (US) Michael D Nelson, 1062 California Lane SW, WA98116 SEATTLE, USA (US) Nadine Wohlstadter, 653 Hoffman Chapel Lane, VA22727 MADISON, USA (US)
(30)	<b>Prioritet:</b>	2012.05.15, US, 29/420,956
(55)	<b>Designavbildninger:</b>	

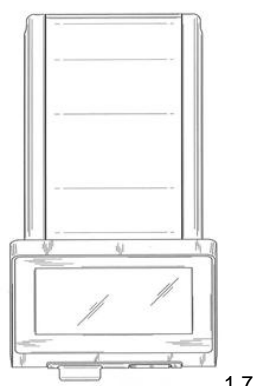
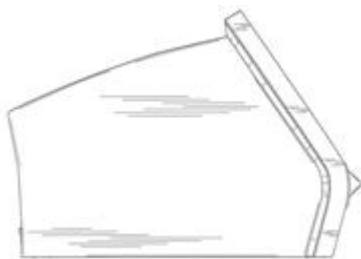
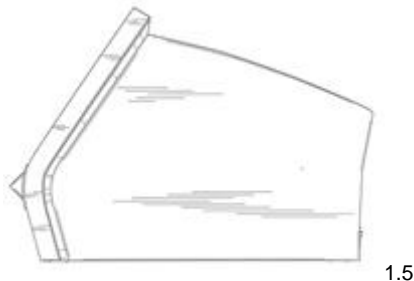
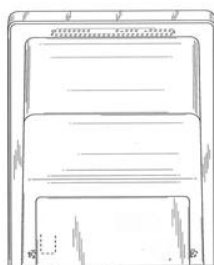
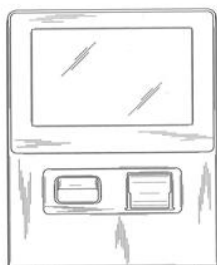
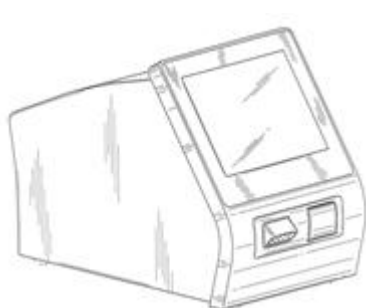

(11)	<b>Reg.nr.:</b>	<b>083795</b>
(21)	<b>Søkn.nr.:</b>	20120970
(22)	<b>Inngitt:</b>	2012.11.22
(24)	<b>Løpedag:</b>	2012.11.22
(43)	<b>Allm. tilgj.:</b>	2012.12.11
(15)	<b>Registrert:</b>	2013.01.16
(45)	<b>Kunngjort:</b>	2013.02.04
(18)	<b>Reg. gjelder til:</b>	2017.11.22
(74)	<b>Fullmektig:</b>	Zacco Norway AS, Postboks 2003 Vika, 0125 OSLO, Norge
(73)	<b>Innehaber:</b>	Scania CV AB, SE-15187 SÖDERTÄLJE, Sverige

**Design 1**

(54)	<b>Produkt:</b>	Spotlampe for kjøretøy
(51)	<b>Klasse:</b>	26-06
(72)	<b>Designern:</b>	Kristofer Hansén, Wollmar Yxkullsgatan 2, 11850 STOCKHOLM, Sverige (SE) Xavier Carreras-Castro, Bredablicksvägen 16, 18142 LIDINGÖ, Sverige (SE) Peter Kjellman, Fyrwerkerbacken 3, 11260 STOCKHOLM, Sverige (SE)
(30)	<b>Prioritet:</b>	2012.06.11, SE, 120259
(55)	<b>Designavbildninger:</b>	



1.1



1.2



1.3



1.4



1.5

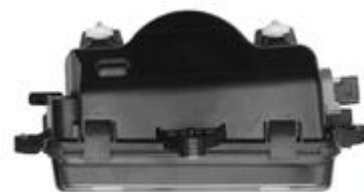

1.6



1.7



1.8

(11)	<b>Reg.nr.:</b>	<b>083796</b>
(21)	<b>Søkn.nr.:</b>	20120965
(22)	<b>Inngitt:</b>	2012.11.20
(24)	<b>Løpedag:</b>	2012.11.20
(43)	<b>Allm. tilgj.:</b>	2012.11.20
(15)	<b>Registrert:</b>	2013.01.17
(45)	<b>Kunngjort:</b>	2013.02.04
(18)	<b>Reg. gjelder til:</b>	2017.11.20
(74)	<b>Fullmektig:</b>	Acapo AS, Postboks 1880 Nordnes, 5817 BERGEN, Norge
(73)	<b>Innehaver:</b>	Wema Systems AS, Lønningsflaten 21, 5258 BLOMSTERDALEN, Norge
(50)	<b>Anmerkninger:</b>	Registreringen gjelder samregistrering.

### Design 1

(54)	<b>Produkt:</b>	Kvalitetssensor for kjøretøy
(51)	<b>Klasse:</b>	10-04
(72)	<b>Designer:</b>	Bjørn Erlend Frivik, Frantz Meyers vei 31, 5232 PARADIS
(55)	<b>Designavbildninger:</b>	

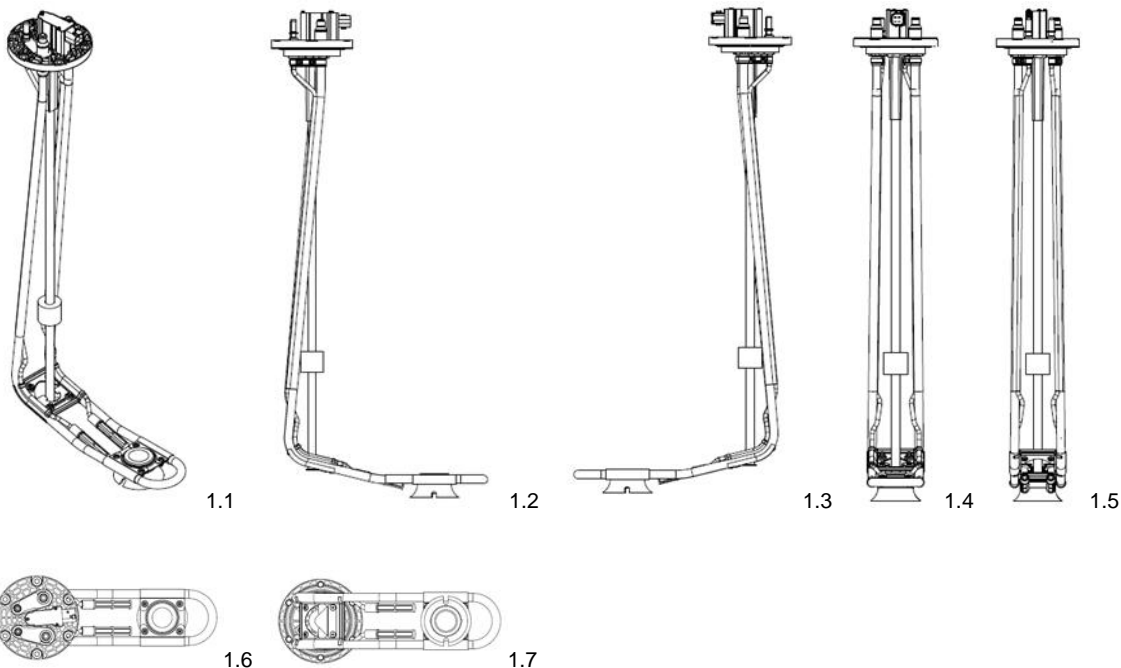

### Design 2

(54)	<b>Produkt:</b>	Kvalitetssensor for kjøretøy
(51)	<b>Klasse:</b>	10-04
(72)	<b>Designer:</b>	Bjørn Erlend Frivik, Frantz Meyers vei 31, 5232 PARADIS
(55)	<b>Designavbildninger:</b>	

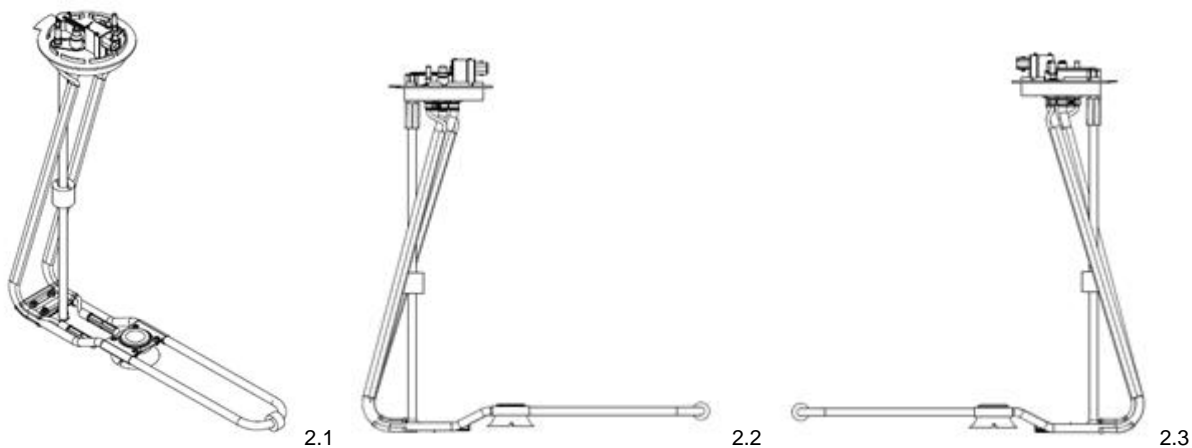

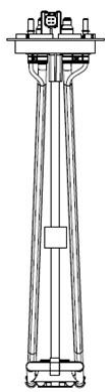

2.4

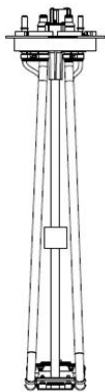

2.5

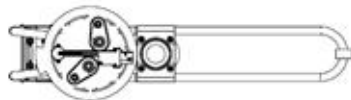

2.6

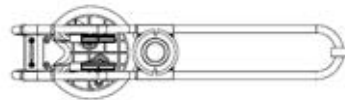

2.7



(11)	<b>Reg.nr.:</b>	<b>083797</b>
(21)	<b>Søkn.nr.:</b>	20120693
(22)	<b>Inngitt:</b>	2012.08.09
(24)	<b>Løpedag:</b>	2012.08.09
(43)	<b>Allm. tilgj.:</b>	2012.08.09
(15)	<b>Registrert:</b>	2013.01.17
(45)	<b>Kunngjort:</b>	2013.02.04
(18)	<b>Reg. gjelder til:</b>	2017.08.09
(73)	<b>Innehaver:</b>	MESTERBAKEREN HOLDING AS, Gamle Forusvei 20, 4033 STAVANGER, Norge
(50)	<b>Anmerkninger:</b>	Registreringen gjelder samregistrering.

**Design 1**

(54)	<b>Produkt:</b>	Logo
(51)	<b>Klasse:</b>	32-00
(72)	<b>Designer:</b>	KNOWIT REAKTOR DESIGN AS, Nagelgården 6 5004
(55)	<b>Designavbildninger:</b>	

**CHRISTIANIA**  
**BAKERI** 1.1

**Design 2**

(54)	<b>Produkt:</b>	Logo
(51)	<b>Klasse:</b>	32-00
(72)	<b>Designer:</b>	KNOWIT REAKTOR DESIGN AS, Nagelgården 6 5004
(55)	<b>Designavbildninger:</b>	

**NORDRE VESTLAND**  
**BAKERI** 2.1

**Design 3**

(54)	<b>Produkt:</b>	Logo
(51)	<b>Klasse:</b>	32-00
(72)	<b>Designer:</b>	KNOWIT REAKTOR DESIGN AS, Nagelgården 6 5004
(55)	<b>Designavbildninger:</b>	

**BJØRGVIN**  
**BAKERI** 3.1

**Design 4**

(54)	<b>Produkt:</b>	Logo
(51)	<b>Klasse:</b>	32-00
(72)	<b>Designer:</b>	KNOWIT REAKTOR DESIGN AS, Nagelgården 6 5004
(55)	<b>Designavbildninger:</b>	

**STAVANGER**  
**BAKERI** 4.1

**Design 5**

- (54) **Produkt:** Logo  
(51) **Klasse:** 32-00  
(72) **Designer:** KNOWIT REAKTOR DESIGN AS, Nagelgården 6 5004  
(55) **Designavbildninger:**

STIFTSTADEN  
BAKERI

5.1

**Design 6**

- (54) **Produkt:** Logo  
(51) **Klasse:** 32-00  
(72) **Designer:** KNOWIT REAKTOR DESIGN AS, Nagelgården 6 5004  
(55) **Designavbildninger:**

SØRLANDET  
BAKERI

6.1

(11)	<b>Reg.nr.:</b>	<b>083798</b>
(21)	<b>Søkn.nr.:</b>	20120954
(22)	<b>Inngitt:</b>	2012.11.06
(24)	<b>Løpedag:</b>	2012.11.06
(43)	<b>Allm. tilgj.:</b>	2013.01.17
(15)	<b>Registrert:</b>	2013.01.17
(45)	<b>Kunngjort:</b>	2013.02.04
(18)	<b>Reg. gjelder til:</b>	2017.11.06
(74)	<b>Fullmektig:</b>	Protector Intellectual Property Consultants AS, Oscarsgate 20, 0352 OSLO, Norge
(73)	<b>Innehaver:</b>	EKA-knivar AB, Box 6, SE-63102 ESKILSTUNA, Sverige

**Design 1**

(54)	<b>Produkt:</b>	Foldekniv
(51)	<b>Klasse:</b>	08-03
(72)	<b>Designer:</b>	Johny Kanaan, Rademachergatan 2, 63220 ESKILSTUNA, Sverige (SE)
(30)	<b>Prioritet:</b>	2012.10.11, EM, 002117093
(55)	<b>Designavbildninger:</b>	

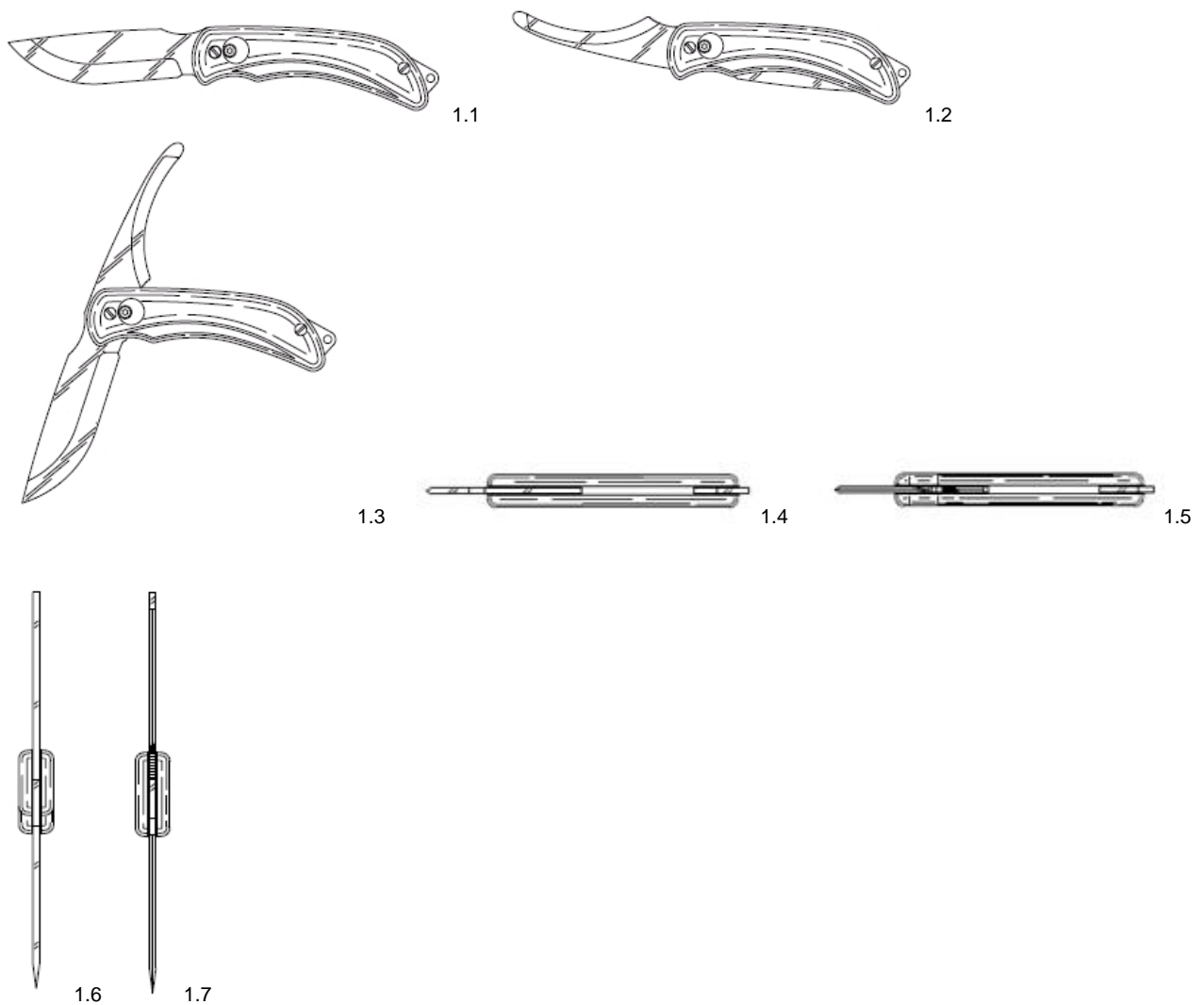

(11)	<b>Reg.nr.:</b>	<b>083799</b>
(21)	<b>Søkn.nr.:</b>	20120972
(22)	<b>Inngitt:</b>	2012.11.22
(24)	<b>Løpedag:</b>	2012.11.22
(43)	<b>Allm. tilgj.:</b>	2012.12.11
(15)	<b>Registrert:</b>	2013.01.17
(45)	<b>Kunngjort:</b>	2013.02.04
(18)	<b>Reg. gjelder til:</b>	2017.11.22
(74)	<b>Fullmektig:</b>	Zacco Norway AS, Postboks 2003 Vika, 0125 OSLO, Norge
(73)	<b>Innehaber:</b>	Scania CV AB, SE-15187 SÖDERTÄLJE, Sverige

### Design 1

(54)	<b>Produkt:</b>	Frontlys for kjøretøy
(51)	<b>Klasse:</b>	26-06
(72)	<b>Designere:</b>	Kristofer Hansén, Wollmar Yxkullsgatan 2, 11850 STOCKHOLM, Sverige (SE) Xavier Carreras-Castro, Bredablicksvägen 16, 18142 LIDINGÖ, Sverige (SE) Peter Kjellman, Fyrverkarbacken 3, 11260 STOCKHOLM, Sverige (SE) Estanislau Mateu, Av/Prat de la Riba 41 bis, 43201 REUS/CATALONIA, Spania (ES)
(30)	<b>Prioritet:</b>	2012.06.11, SE, 120260
(55)	<b>Designavbildninger:</b>	

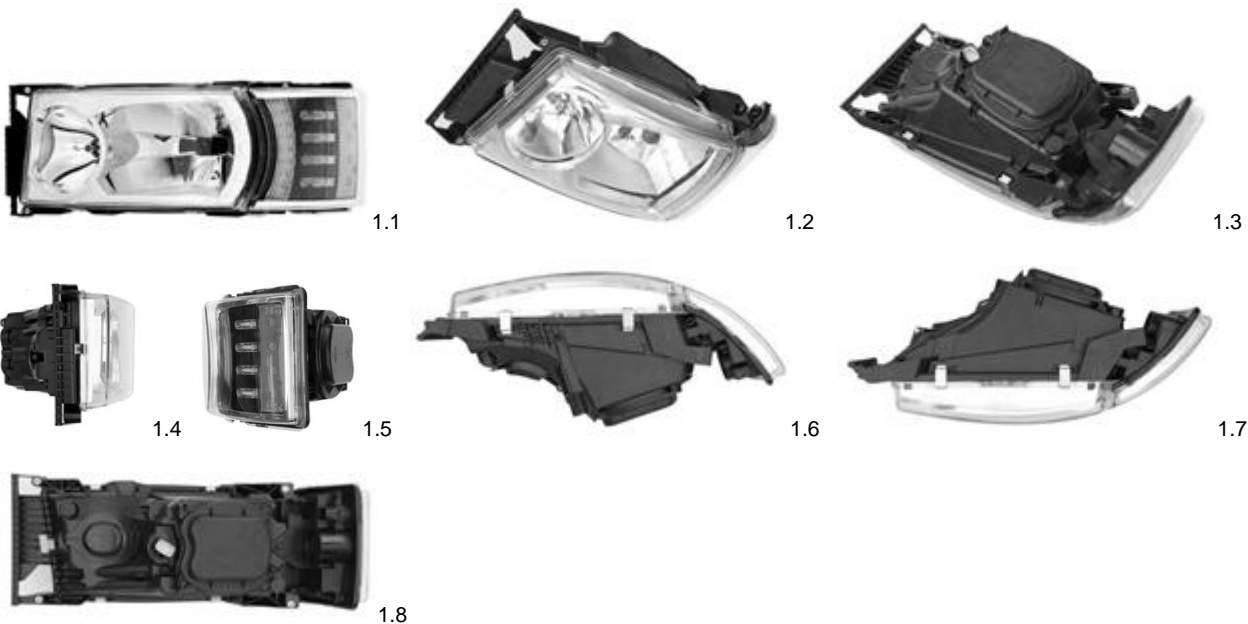

- (11) **Reg.nr.:** 083800  
(21) **Søkn.nr.:** 20120875  
(22) **Inngitt:** 2012.10.16  
(24) **Løpedag:** 2012.10.16  
(43) **Allm. tilgj.:** 2012.10.16  
(15) **Registrert:** 2013.01.18  
(45) **Kunngjort:** 2013.02.04  
(18) **Reg. gjelder til:** 2017.10.16  
(73) **Innehaver:** Picpac AS, Jacob Aalls gate 48, 0364 OSLO, Norge  
(50) **Anmerkninger:** Designene er i farger.  
Registreringen gjelder samregistrering.

### Design 1

- (54) **Produkt:** Skobag  
(51) **Klasse:** 03-01  
(72) **Designert:** WORK AS, Pilestredet 75C, 0354 OSLO  
Ian Sandmæl, Fritznersgate 20, 0264 OSLO  
Simen Aarseth, Helgesensgate 32, 0553 OSLO  
(55) **Designavbildninger:**



**Design 2**

- (54) **Produkt:** Bag med lommer  
(51) **Klasse:** 03-01  
(72) **Designer:** WORK AS, Pilestredet 75C, 0354 OSLO  
Ian Sandmæl, Fritznersgate 20, 0264 OSLO  
Simen Aarseth, Helgesensgate 32, 0553 OSLO
- (55) **Designavbildninger:**



2.1



2.2



2.3



2.4

(11)	<b>Reg.nr.:</b>	<b>083801</b>
(21)	<b>Søkn.nr.:</b>	20120798
(22)	<b>Inngitt:</b>	2012.09.25
(24)	<b>Løpedag:</b>	2012.09.25
(43)	<b>Allm. tilgj.:</b>	2013.01.18
(15)	<b>Registrert:</b>	2013.01.18
(45)	<b>Kunngjort:</b>	2013.02.04
(18)	<b>Reg. gjelder til:</b>	2017.09.25
(74)	<b>Fullmektig:</b>	Advokatfirma Ræder DA, Postboks 2944 Solli, 0230 OSLO, Norge
(73)	<b>Innehaver:</b>	Moods of Norway AS, Tinggata 22, 6783 STRYN, Norge

### Design 1

(54)	<b>Produkt:</b>	Parfymeflakong
(51)	<b>Klasse:</b>	09-01
(72)	<b>Designer:</b>	Edward Longden, c/o Moods of Norway AS, Tinggata 22, 6783 STRYN
(55)	<b>Designavbildninger:</b>	



1.1

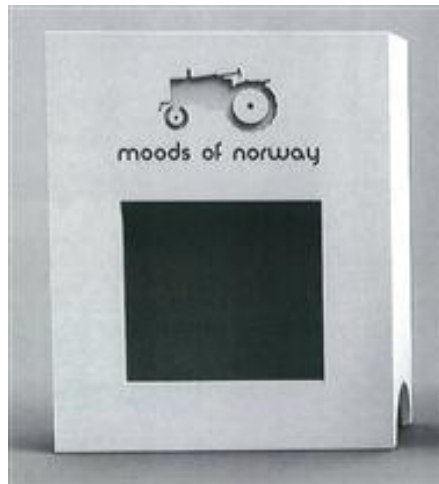

1.2

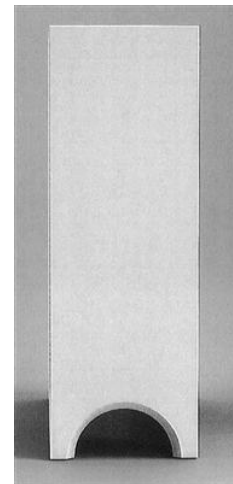

1.3

## Internasjonale designregistreringer

I henhold til designloven § 57 fjerde ledd, kunngjøres i dag følgende internasjonale registreringer som har virkning i Norge.

Det kan fremsettes krav om at designregistreringen helt eller delvis skal oppheves, jf. designloven §§ 58 fjerde ledd og 25 flg. og designforskriften §§ 26 flg.

Virkingen av en internasjonal registrering gjelder for den eller de periodene på fem år som søknaden er innlevert for, regnet fra den dagen registreringen ved det Internasjonale byrået anses å ha skjedd. Registreringen kan fornyes etter bestemmelsene i Genèveavtalen, se dl § 58 tredje ledd. Maksimal beskyttelsestid er 25 år.

(11)	<b>Reg.nr.:</b>	<b>DM/078519</b>
(21)	<b>Søkn.nr.:</b>	20120652
(22)	<b>Inngitt:</b>	2012.06.15
(24)	<b>Løpedag:</b>	2012.06.15
(43)	<b>Allm. tilgj.:</b>	2012.12.21
(15)	<b>Registrert:</b>	2012.06.15
(45)	<b>Kunngjort:</b>	2013.02.04
(18)	<b>Reg. gjelder til:</b>	2017.06.15
(73)	<b>Innehaver:</b>	Daimler AG, Mercedesstrasse 137, DE-70327 STUTTGART, Tyskland
(50)	<b>Anmerkninger:</b>	Registreringen gjelder samregistrering.

### Design 1

(54)	<b>Produkt:</b>	Radiator grille for vehicle
(51)	<b>Klasse:</b>	12-16
(72)	<b>Designer:</b>	Mark Fetherston, c/o Daimler AG, Mercedesstrasse 137, 70327 STUTTGART, Tyskland (DE)
(30)	<b>Prioritet:</b>	2012.03.01, EM, 002001040
(55)	<b>Designavbildninger:</b>	

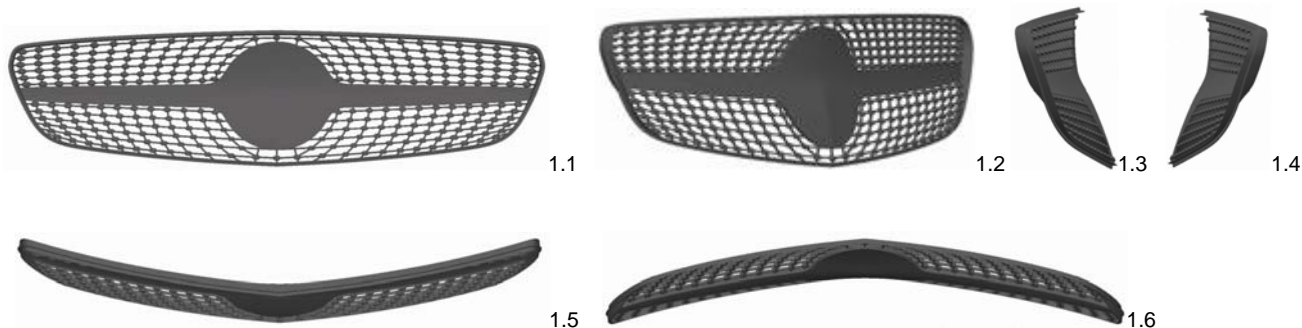

### Design 2

(54)	<b>Produkt:</b>	Bumpers for vehicles
(51)	<b>Klasse:</b>	12-16
(72)	<b>Designer:</b>	Klaus Frenzel, c/o Daimler AG, Mercedesstrasse 137, 70327 STUTTGART, Tyskland (DE)
(30)	<b>Prioritet:</b>	2012.03.01, EM, 002001040
(55)	<b>Designavbildninger:</b>	







2.4



2.5



2.6

**Design 3**

(54)	<b>Produkt:</b>	Bumpers for vehicles
(51)	<b>Klasse:</b>	12-16
(72)	<b>Designer:</b>	Gorden Wagener, c/o Daimler AG, Mercedesstrasse 137, 70327 STUTTGART, Tyskland (DE) Hans-Dieter Futschik, c/o Daimler AG, Mercedesstrasse 137, 70327 STUTTGART, Tyskland (DE)
(30)	<b>Prioritet:</b>	2012.03.01, EM, 002001040
(55)	<b>Designavbildninger:</b>	



3.1



3.2



3.3



3.4



3.5



3.6

(11)	<b>Reg.nr.:</b>	<b>DM/078560</b>
(21)	<b>Søkn.nr.:</b>	20120669
(22)	<b>Inngitt:</b>	2012.05.30
(24)	<b>Løpedag:</b>	2012.05.30
(43)	<b>Allm. tilgj.:</b>	2012.11.30
(15)	<b>Registrert:</b>	2012.05.30
(45)	<b>Kunngjort:</b>	2013.02.04
(18)	<b>Reg. gjelder til:</b>	2017.05.30
(73)	<b>Innehaver:</b>	Patrick Mayer, Haus Jelen, Postfach 109, CH-7050 AROSA, Sveits

**Design 1**

(54)	<b>Produkt:</b>	Attachment for wheelchair wheels
(51)	<b>Klasse:</b>	12-12
(72)	<b>Designer:</b>	Patrick Mayer, Haus Jelen, Postfach 109, 7050 AROSA, Sveits (CH) Roger Dejakum, Bahnhofstrasse 3, 8340 HINWIL, Sveits (CH) Urs Egger, Oberseestrasse 10, 8640 RAPPERSWIL, Sveits (CH)
(55)	<b>Designavbildninger:</b>	

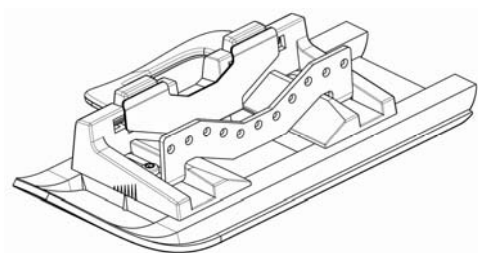

1.1

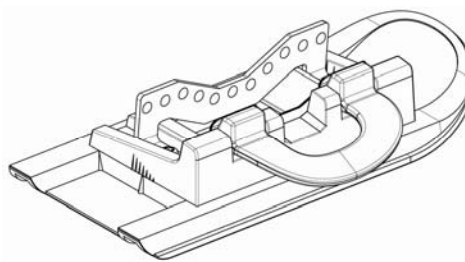

1.2



1.3

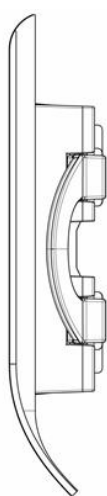

1.4

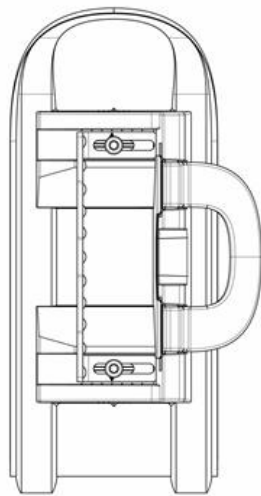

1.5

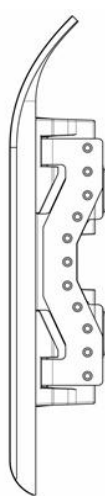

1.6

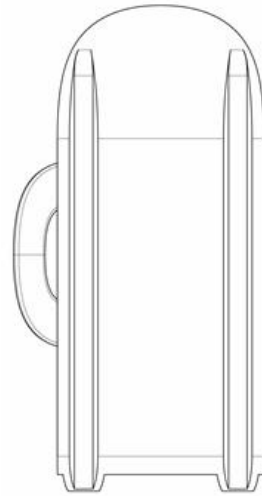

1.7



1.8

(11)	<b>Reg.nr.:</b>	<b>DM/078566</b>
(21)	<b>Søkn.nr.:</b>	20120672
(22)	<b>Inngitt:</b>	2012.06.19
(24)	<b>Løpedag:</b>	2012.06.19
(43)	<b>Allm. tilgj.:</b>	2012.12.21
(15)	<b>Registrert:</b>	2012.06.19
(45)	<b>Kunngjort:</b>	2013.02.04
(18)	<b>Reg. gjelder til:</b>	2017.06.19
(73)	<b>Innehaver:</b>	Nokia Corporation, Keilalahdentie 4, FI-02150 ESBO, Finland
(50)	<b>Anmerkninger:</b>	Registreringen gjelder samregistrering.

## Design 1

(54)	<b>Produkt:</b>	Display screens with user interface
(51)	<b>Klasse:</b>	14-04
(72)	<b>Designer:</b>	Kort Sands, 56 Gayhurst Road, E83EL LONDON, Storbritannia (GB) Brian Kralyevich, 27 Oatlands Close, KT139EE WEYBRIDGE, SURREY, Storbritannia (GB) Felice Mancino, Eerikinkatu 42 A 8, 00180 HELSINGFORS, Finland (FI) Estibaliz Landa, Flat 1, 21 Well Street, E97QX LONDON, Storbritannia (GB) Thomas Moltoni, 30 Prince Of Wales Drive, Battersea, SW114SF LONDON, Storbritannia (GB) Jason Gold, Flat 302, 46-48 Commercial Street, E16LT LONDON, Storbritannia (GB) Teemu Äijälä, Honkatie 4a 12, 00270 HELSINGFORS, Finland (FI)
(55)	<b>Designavbildninger:</b>	

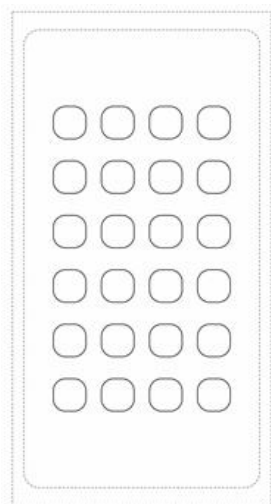

1.1

**Design 2**

- (54) **Produkt:** Display screens with user interface
- (51) **Klasse:** 14-04
- (72) **Designer:** Anton Fahlgren, Kapteeninkatu 9A, 00140 HELSINGFORS, Finland (FI)  
Casper Asmussen, Ankargatan 9, 21117 MALMÖ, Sverige (SE)  
Kort Sands, 56 Gayhurst Road, E83EL LONDON, Storbritannia (GB)  
Brian Kralyevich, 27 Oatlands Close, KT139EE WEYBRIDGE, SURREY, Storbritannia (GB)  
Felice Mancino, Eerikinkatu 42 A 8, 00180 HELSINGFORS, Finland (FI)  
Estibaliz Landa, Flat 1, 21 Well Street, E97QX LONDON, Storbritannia (GB)  
Thomas Moltoni, 30 Prince Of Wales Drive, Battersea, SW114SF LONDON, Storbritannia (GB)  
Jason Gold, Flat 302, 46-48 Commercial Street, E16LT LONDON, Storbritannia (GB)  
Teemu Äijälä, Honkatie 4a 12, 00270 HELSINGFORS, Finland (FI)
- (55) **Designavbildninger:**

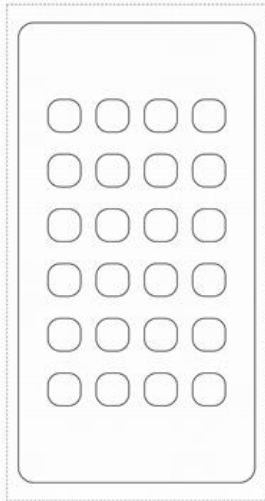

2.1

(11)	<b>Reg.nr.:</b>	<b>DM/078605</b>
(21)	<b>Søkn.nr.:</b>	20120727
(22)	<b>Inngitt:</b>	2012.06.20
(24)	<b>Løpedag:</b>	2012.06.20
(43)	<b>Allm. tilgj.:</b>	2012.12.21
(15)	<b>Registrert:</b>	2012.06.20
(45)	<b>Kunngjort:</b>	2013.02.04
(18)	<b>Reg. gjelder til:</b>	2017.06.20
(73)	<b>Innehaber:</b>	Philip Morris Products SA, Quai Jeanrenaud 3, CH-2000 NEUCHÂTEL , Sveits
(50)	<b>Anmerkninger:</b>	Registreringen gjelder samregistrering.

**Design 1**

(54)	<b>Produkt:</b>	Hand-held aerosol generators
(51)	<b>Klasse:</b>	27-99
(72)	<b>Designer:</b>	Gregor Mittersinker, 134 Spring Green Rd., RI02888 WARWICK, USA (US)
(30)	<b>Prioritet:</b>	2011.12.23, EM, 001307649
(55)	<b>Designavbildninger:</b>	

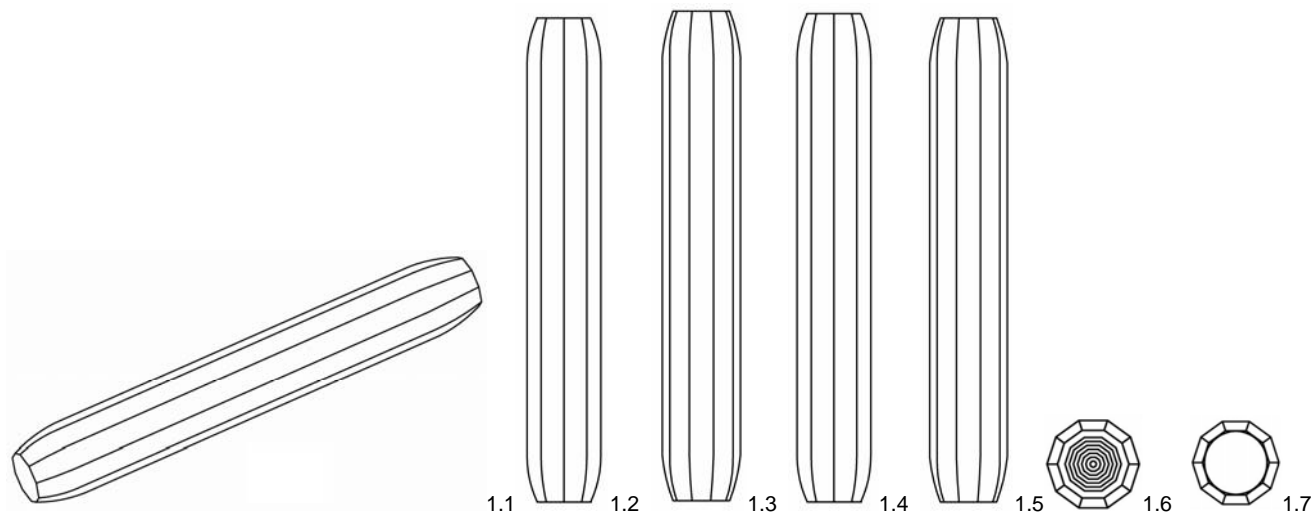
**Design 2**

(54)	<b>Produkt:</b>	Hand-held aerosol generators
(51)	<b>Klasse:</b>	27-99
(72)	<b>Designer:</b>	Aaron Abroff, 117 Hosmer St., MA01720 ACTON, USA (US) Laurent Manca, Chemin de la Thioleyre 1, 1091 GRANDVAUX, Sveits (CH)
(30)	<b>Prioritet:</b>	2011.12.23, EM, 001307649
(55)	<b>Designavbildninger:</b>	

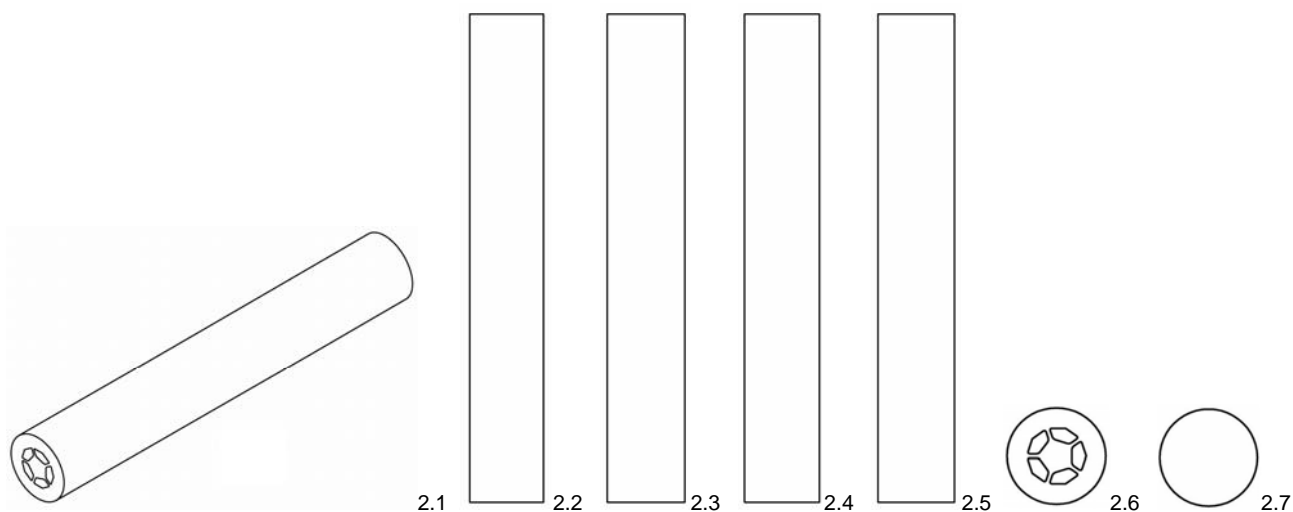

**Design 3**

(54) **Produkt:** Hand-held aerosol generators  
 (51) **Klasse:** 27-99  
 (72) **Designer:** Aaron Abroff, 117 Hosmer St., MA01720 ACTON, USA (US)  
 (30) **Prioritet:** 2011.12.23, EM, 001307649  
 (55) **Designavbildninger:**

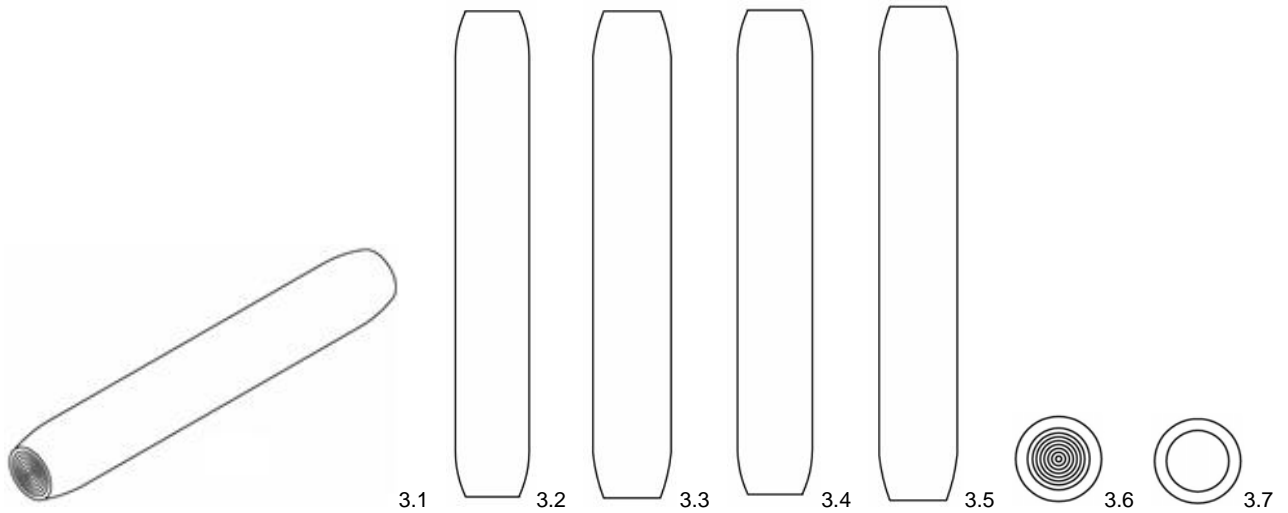

**Design 4**

(54) **Produkt:** Hand-held aerosol generators  
 (51) **Klasse:** 27-99  
 (72) **Designer:** Aaron Abroff, 117 Hosmer St., MA01720 ACTON, USA (US)  
 (30) **Prioritet:** 2011.12.23, EM, 001307649  
 (55) **Designavbildninger:**

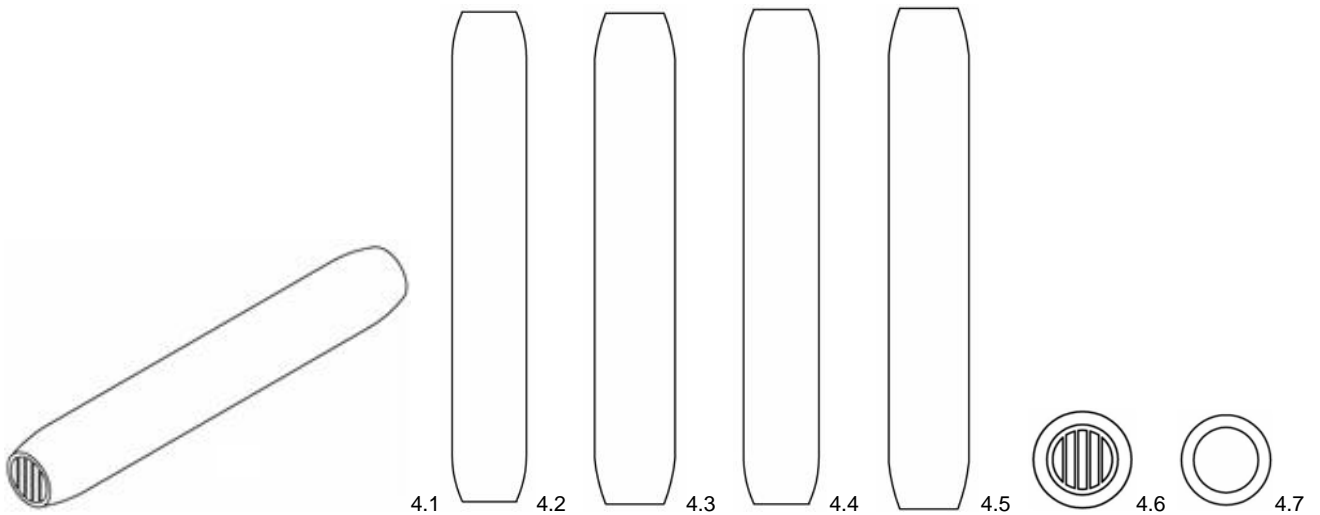

**Design 5**

(54) **Produkt:** Hand-held aerosol generators  
 (51) **Klasse:** 27-99  
 (72) **Designer:** Aaron Abroff, 117 Hosmer St., MA01720 ACTON, USA (US)  
 (30) **Prioritet:** 2011.12.23, EM, 001307649  
 (55) **Designavbildninger:**

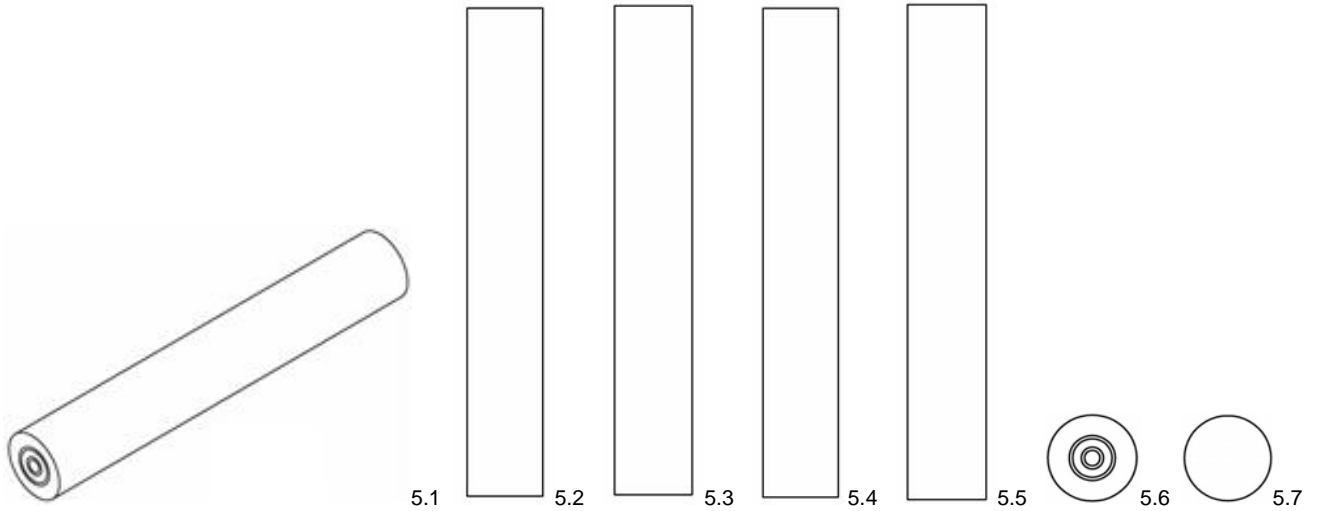

**Design 6**

(54) **Produkt:** Hand-held aerosol generators  
 (51) **Klasse:** 27-99  
 (72) **Designer:** Aaron Abroff, 117 Hosmer St., MA01720 ACTON, USA (US)  
 (30) **Prioritet:** 2011.12.23, EM, 001307649  
 (55) **Designavbildninger:**

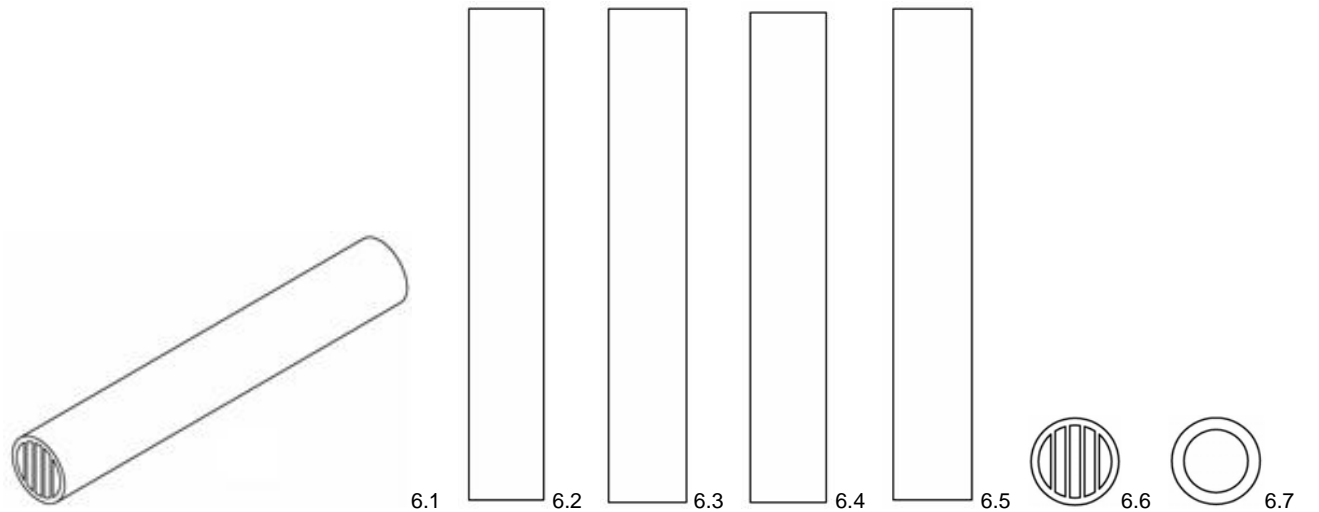

(11)	<b>Reg.nr.:</b>	<b>DM/078606</b>
(21)	<b>Søkn.nr.:</b>	20120728
(22)	<b>Inngitt:</b>	2012.06.21
(24)	<b>Løpedag:</b>	2012.06.21
(43)	<b>Allm. tilgj.:</b>	2012.12.21
(15)	<b>Registrert:</b>	2012.06.21
(45)	<b>Kunngjort:</b>	2013.02.04
(18)	<b>Reg. gjelder til:</b>	2017.06.21
(73)	<b>Innehaver:</b>	Philip Morris Products SA, Quai Jeanrenaud 3, CH-2000 NEUCHÂTEL , Sveits
(50)	<b>Anmerkninger:</b>	Registreringen gjelder samregistrering.

**Design 1**

(54)	<b>Produkt:</b>	Hand-held aerosol generators
(51)	<b>Klasse:</b>	27-99
(72)	<b>Designer:</b>	Jonathan Hogwood, 7 Chalkhill Barrow, SG86EQ MELBOURN, ROYSTON, HERTS, Storbritannia (GB) Stuart Cooper, 6 Merle Way, CB236FE LOWER CAMBOURNE, CAMBS, Storbritannia (GB)
(30)	<b>Prioritet:</b>	2011.12.23, EM, 001307631
(55)	<b>Designavbildninger:</b>	

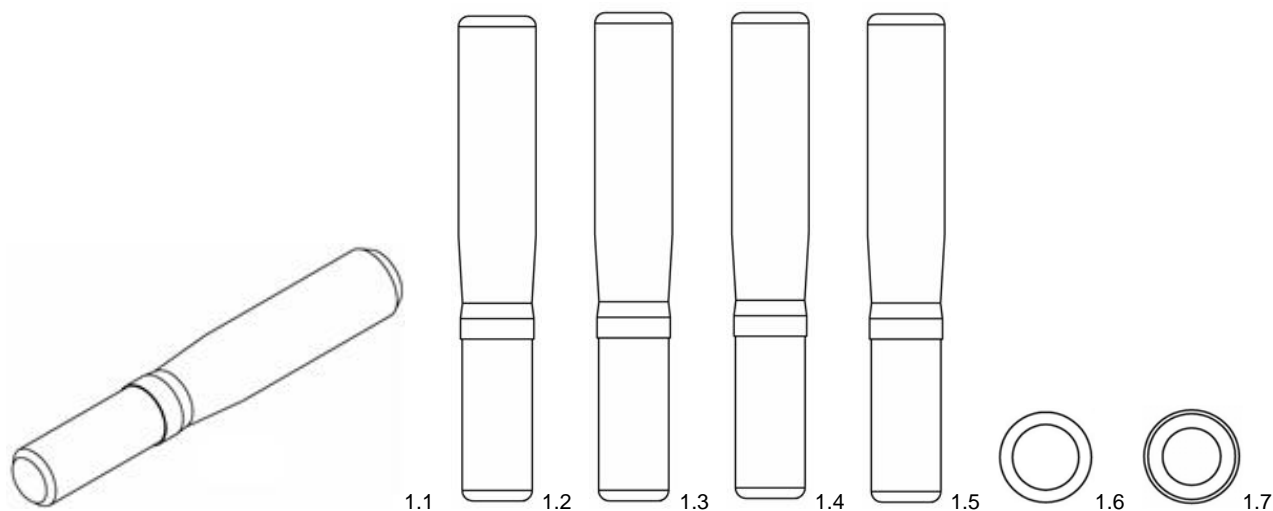
**Design 2**

(54)	<b>Produkt:</b>	Hand-held aerosol generators
(51)	<b>Klasse:</b>	27-99
(72)	<b>Designer:</b>	Jonathan Hogwood, 7 Chalkhill Barrow, SG86EQ MELBOURN, ROYSTON, HERTS, Storbritannia (GB) Stuart Cooper, 6 Merle Way, CB236FE LOWER CAMBOURNE, CAMBS, Storbritannia (GB)
(30)	<b>Prioritet:</b>	2011.12.23, EM, 001307631
(55)	<b>Designavbildninger:</b>	

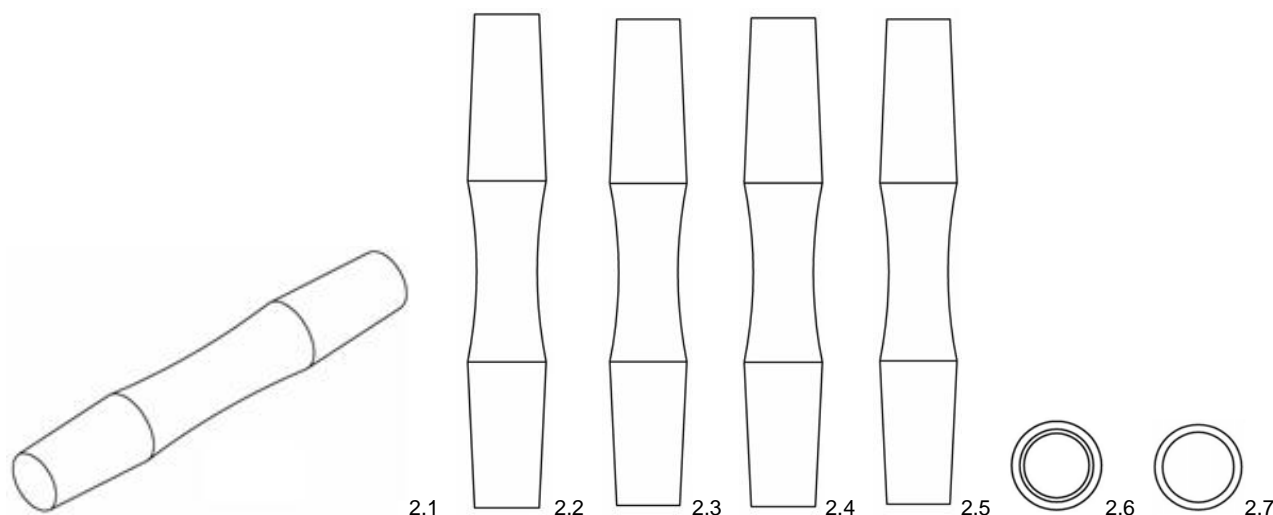



**Design 3**

- (54) **Produkt:** Hand-held aerosol generators  
(51) **Klasse:** 27-99  
(72) **Designer:** Jonathan Hogwood, 7 Chalkhill Barrow, SG86EQ MELBOURN, ROYSTON, HERTS, Storbritannia (GB)  
Stuart Cooper, 6 Merle Way, CB236FE LOWER CAMBOURNE, CAMBS, Storbritannia (GB)  
(30) **Prioritet:** 2011.12.23, EM, 001307631  
(55) **Designavbildninger:**

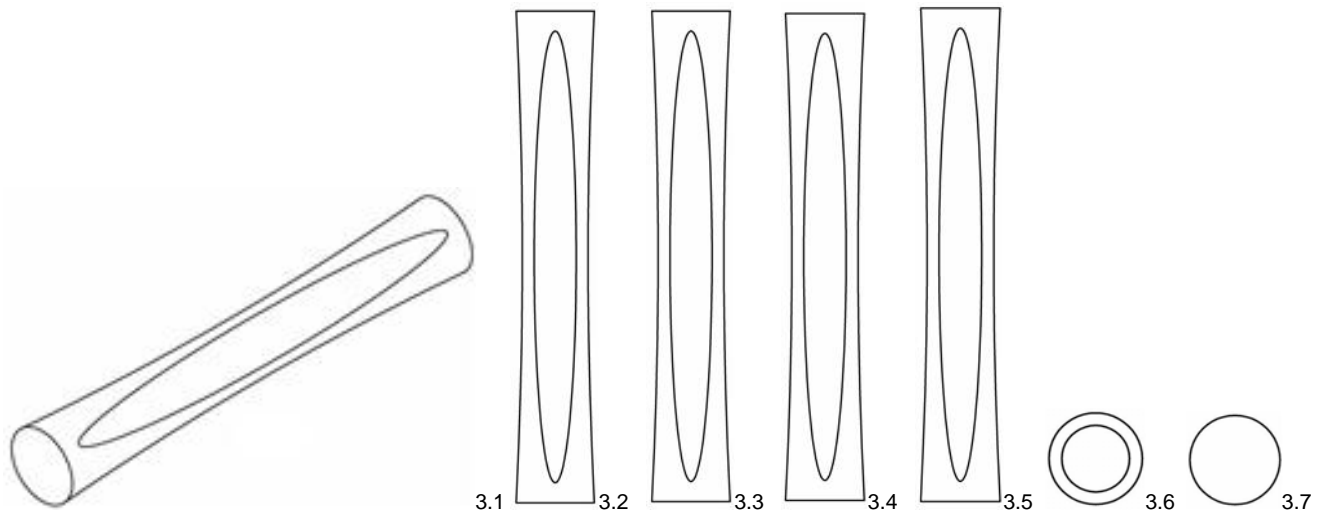
**Design 4**

- (54) **Produkt:** Hand-held aerosol generators  
(51) **Klasse:** 27-99  
(72) **Designer:** Jonathan Hogwood, 7 Chalkhill Barrow, SG86EQ MELBOURN, ROYSTON, HERTS, Storbritannia (GB)  
Stuart Cooper, 6 Merle Way, CB236FE LOWER CAMBOURNE, CAMBS, Storbritannia (GB)  
(30) **Prioritet:** 2011.12.23, EM, 001307631  
(55) **Designavbildninger:**

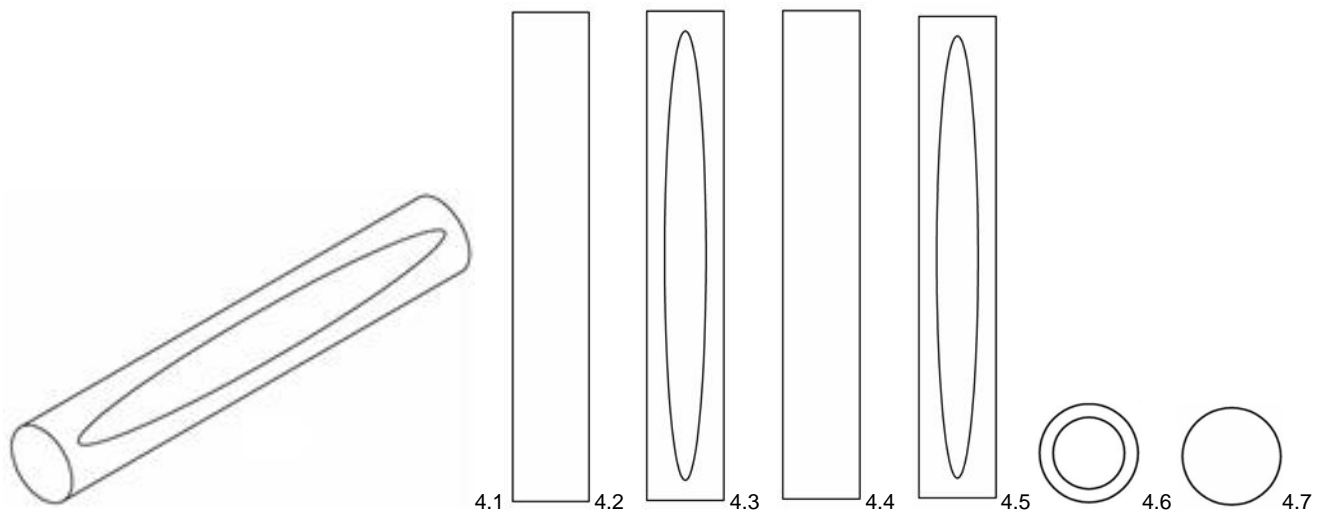

**Design 5**

- (54) **Produkt:** Hand-held aerosol generators  
 (51) **Klasse:** 27-99  
 (72) **Designer:** Jonathan Hogwood, 7 Chalkhill Barrow, SG86EQ MELBOURN, ROYSTON, HERTS, Storbritannia (GB)  
 Stuart Cooper, 6 Merle Way, CB236FE LOWER CAMBOURNE, CAMBS, Storbritannia (GB)  
 2011.12.23, EM, 001307631  
 (30) **Prioritet:**  
 (55) **Designavbildninger:**

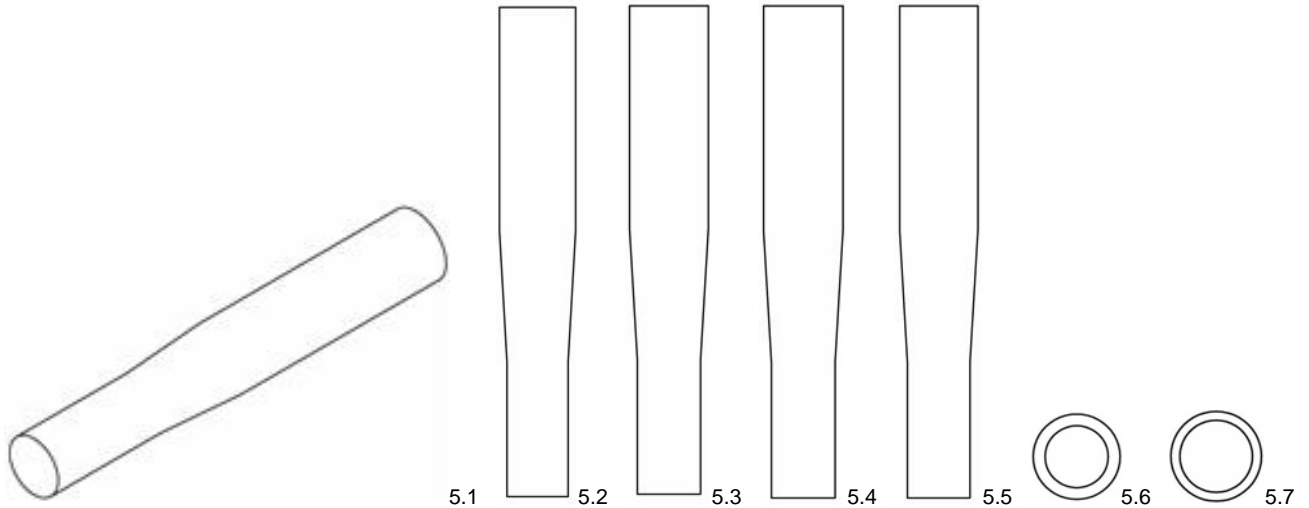
**Design 6**

- (54) **Produkt:** Hand-held aerosol generators  
 (51) **Klasse:** 27-99  
 (72) **Designer:** Jonathan Hogwood, 7 Chalkhill Barrow, SG86EQ MELBOURN, ROYSTON, HERTS, Storbritannia (GB)  
 Stuart Cooper, 6 Merle Way, CB236FE LOWER CAMBOURNE, CAMBS, Storbritannia (GB)  
 2011.12.23, EM, 001307631  
 (30) **Prioritet:**  
 (55) **Designavbildninger:**

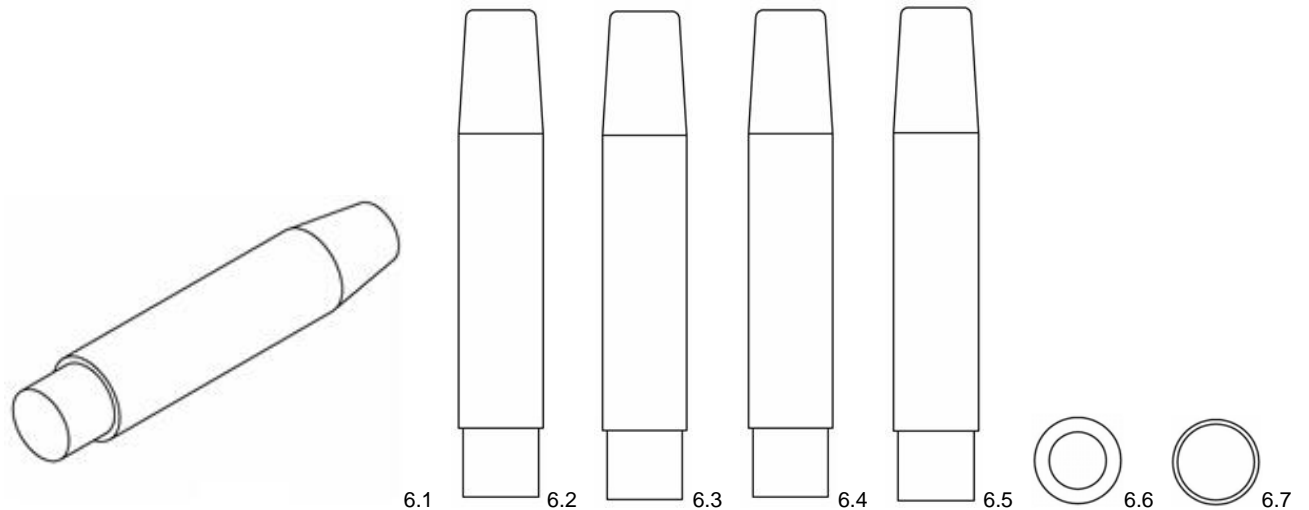

**Design 7**

- (54) **Produkt:** Hand-held aerosol generators  
(51) **Klasse:** 27-99  
(72) **Designer:** Jonathan Hogwood, 7 Chalkhill Barrow, SG86EQ MELBOURN, ROYSTON, HERTS, Storbritannia (GB)  
Stuart Cooper, 6 Merle Way, CB236FE LOWER CAMBOURNE, CAMBS, Storbritannia (GB)  
(30) **Prioritet:** 2011.12.23, EM, 001307631  
(55) **Designavbildninger:**

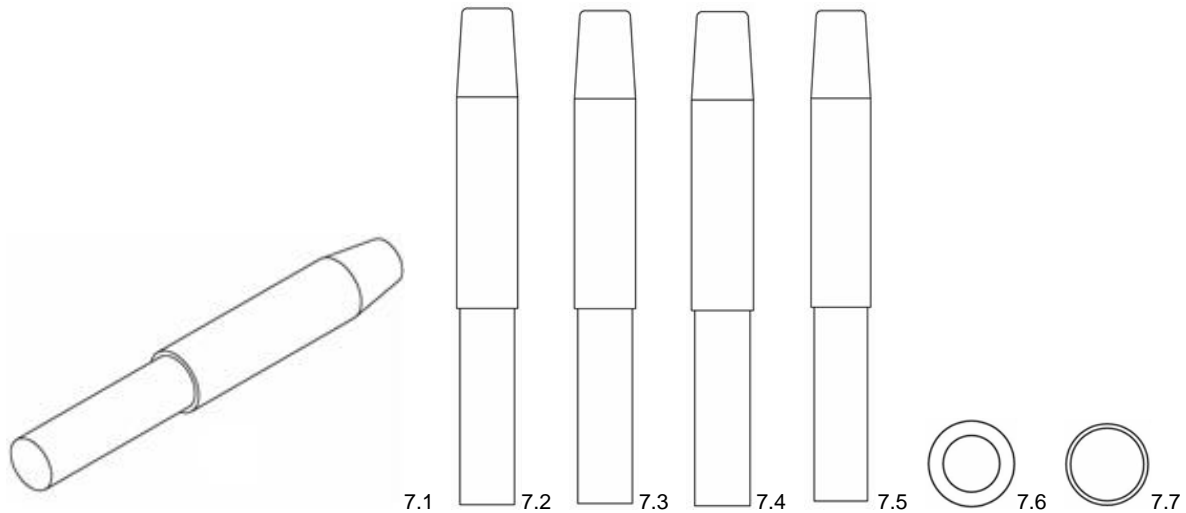
**Design 8**

- (54) **Produkt:** Hand-held aerosol generators  
(51) **Klasse:** 27-99  
(72) **Designer:** Jonathan Hogwood, 7 Chalkhill Barrow, SG86EQ MELBOURN, ROYSTON, HERTS, Storbritannia (GB)  
Stuart Cooper, 6 Merle Way, CB236FE LOWER CAMBOURNE, CAMBS, Storbritannia (GB)  
(30) **Prioritet:** 2011.12.23, EM, 001307631  
(55) **Designavbildninger:**

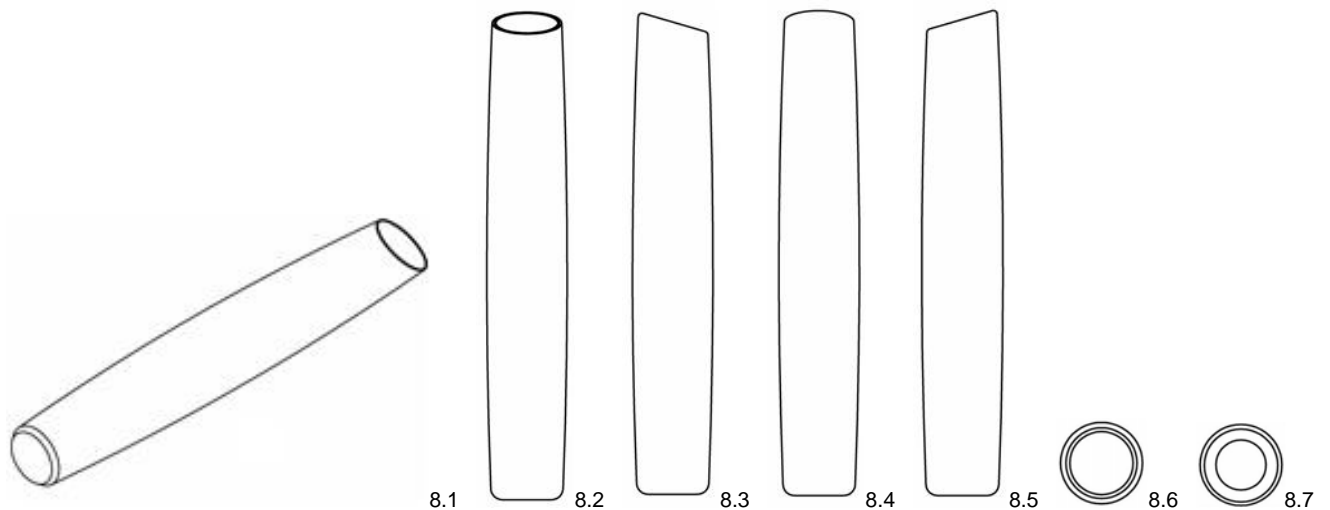

**Design 9**

- (54) **Produkt:** Hand-held aerosol generators  
 (51) **Klasse:** 27-99  
 (72) **Designer:** Jonathan Hogwood, 7 Chalkhill Barrow, SG86EQ MELBOURN, ROYSTON, HERTS, Storbritannia (GB)  
 Stuart Cooper, 6 Merle Way, CB236FE LOWER CAMBOURNE, CAMBS, Storbritannia (GB)  
 2011.12.23, EM, 001307631  
 (30) **Prioritet:**  
 (55) **Designavbildninger:**

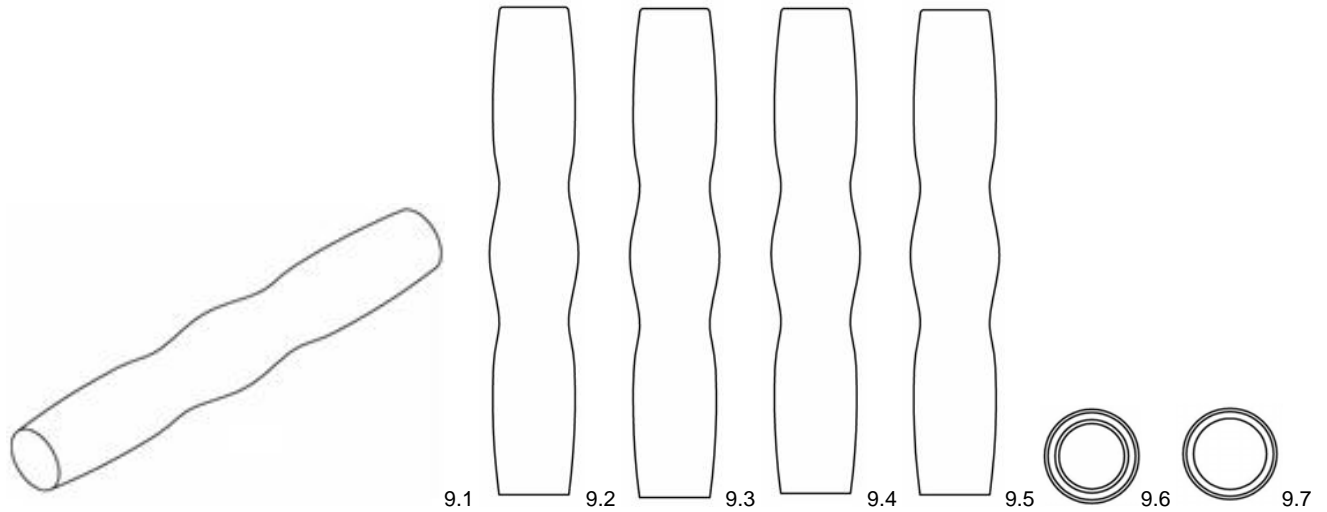
**Design 10**

- (54) **Produkt:** Hand-held aerosol generators  
 (51) **Klasse:** 27-99  
 (72) **Designer:** Jonathan Hogwood, 7 Chalkhill Barrow, SG86EQ MELBOURN, ROYSTON, HERTS, Storbritannia (GB)  
 Stuart Cooper, 6 Merle Way, CB236FE LOWER CAMBOURNE, CAMBS, Storbritannia (GB)  
 2011.12.23, EM, 001307631  
 (30) **Prioritet:**  
 (55) **Designavbildninger:**

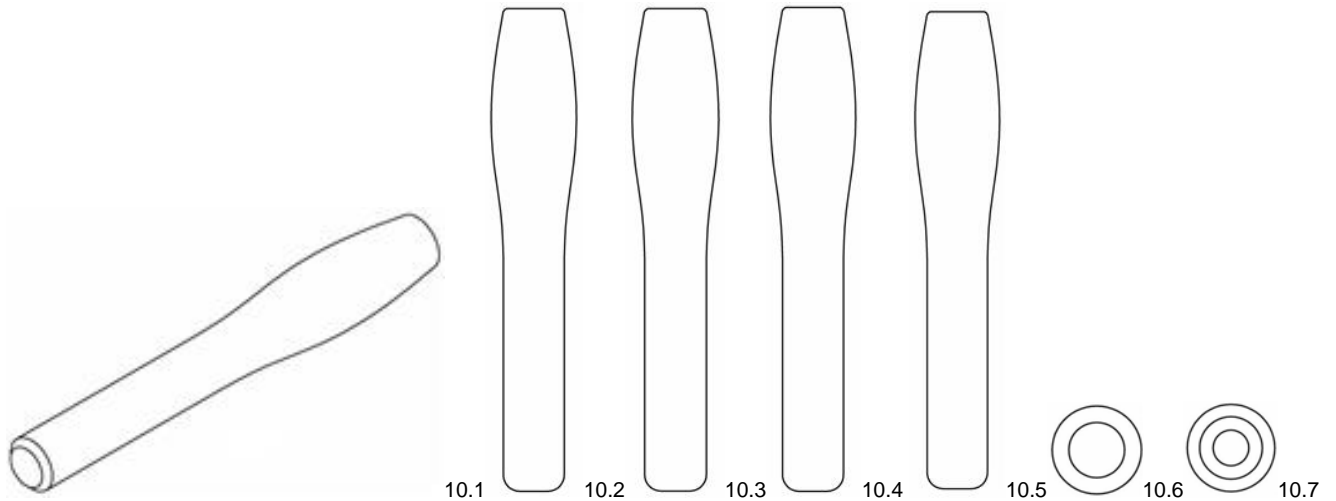

**Design 11**

- (54) **Produkt:** Hand-held aerosol generators  
 (51) **Klasse:** 27-99  
 (72) **Designer:** Jonathan Hogwood, 7 Chalkhill Barrow, SG86EQ MELBOURN, ROYSTON, HERTS, Storbritannia (GB)  
 Stuart Cooper, 6 Merle Way, CB236FE LOWER CAMBOURNE, CAMBS, Storbritannia (GB)  
 (30) **Prioritet:** 2011.12.23, EM, 001307631  
 (55) **Designavbildninger:**

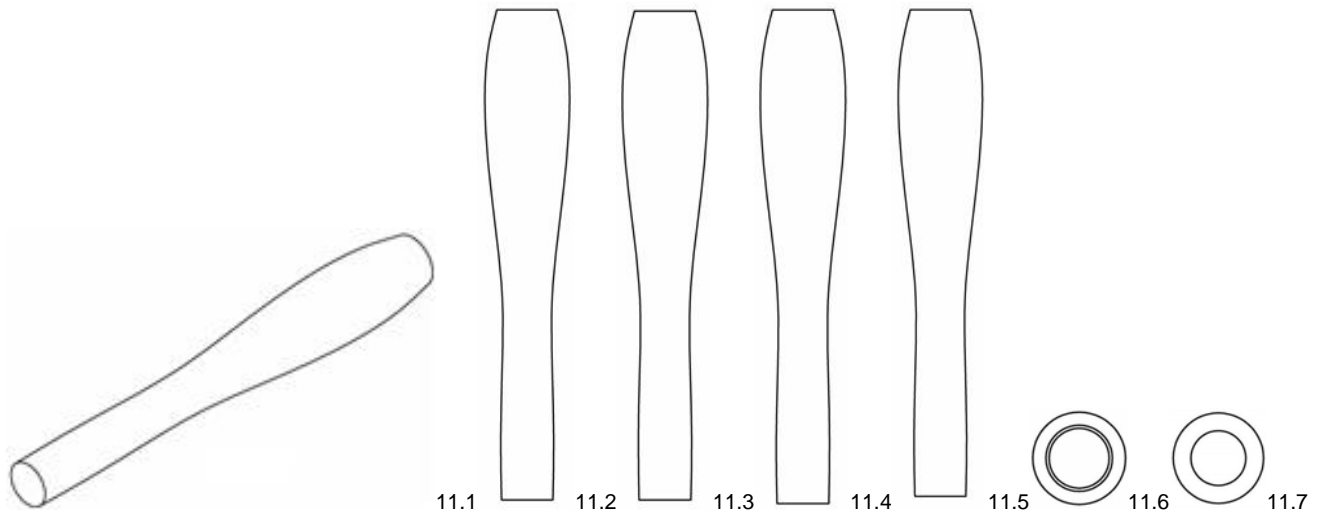
**Design 12**

- (54) **Produkt:** Hand-held aerosol generators  
 (51) **Klasse:** 27-99  
 (72) **Designer:** Jonathan Hogwood, 7 Chalkhill Barrow, SG86EQ MELBOURN, ROYSTON, HERTS, Storbritannia (GB)  
 Stuart Cooper, 6 Merle Way, CB236FE LOWER CAMBOURNE, CAMBS, Storbritannia (GB)  
 (30) **Prioritet:** 2011.12.23, EM, 001307631  
 (55) **Designavbildninger:**

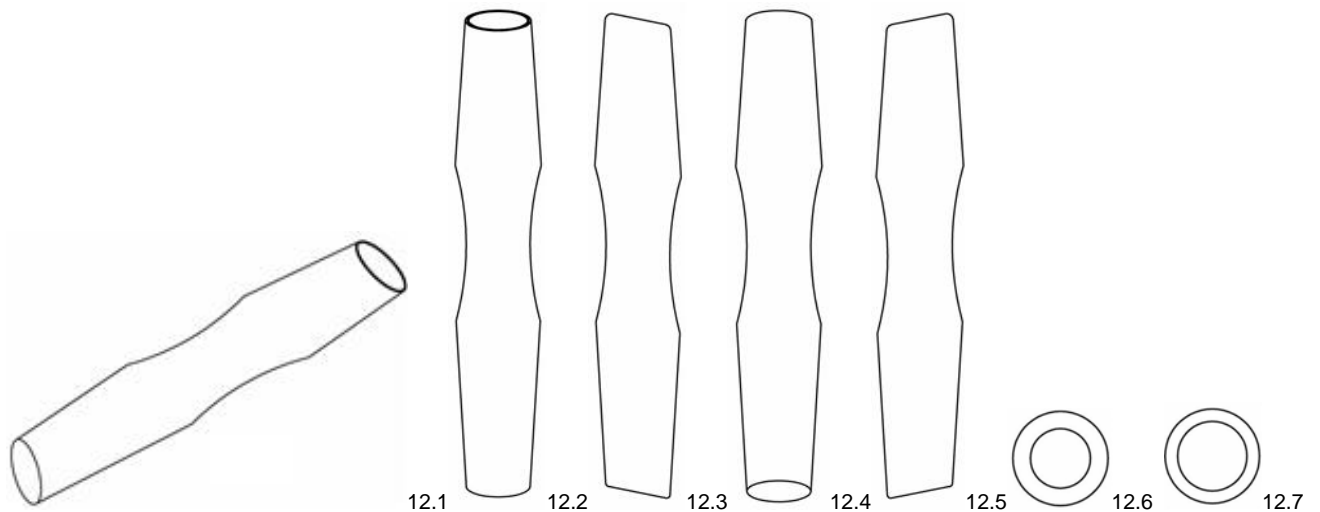

**Design 13**

- (54) **Produkt:** Hand-held aerosol generators  
 (51) **Klasse:** 27-99  
 (72) **Designer:** Jonathan Hogwood, 7 Chalkhill Barrow, SG86EQ MELBOURN, ROYSTON, HERTS, Storbritannia (GB)  
 Stuart Cooper, 6 Merle Way, CB236FE LOWER CAMBOURNE, CAMBS, Storbritannia (GB)  
 2011.12.23, EM, 001307631  
 (30) **Prioritet:**  
 (55) **Designavbildninger:**

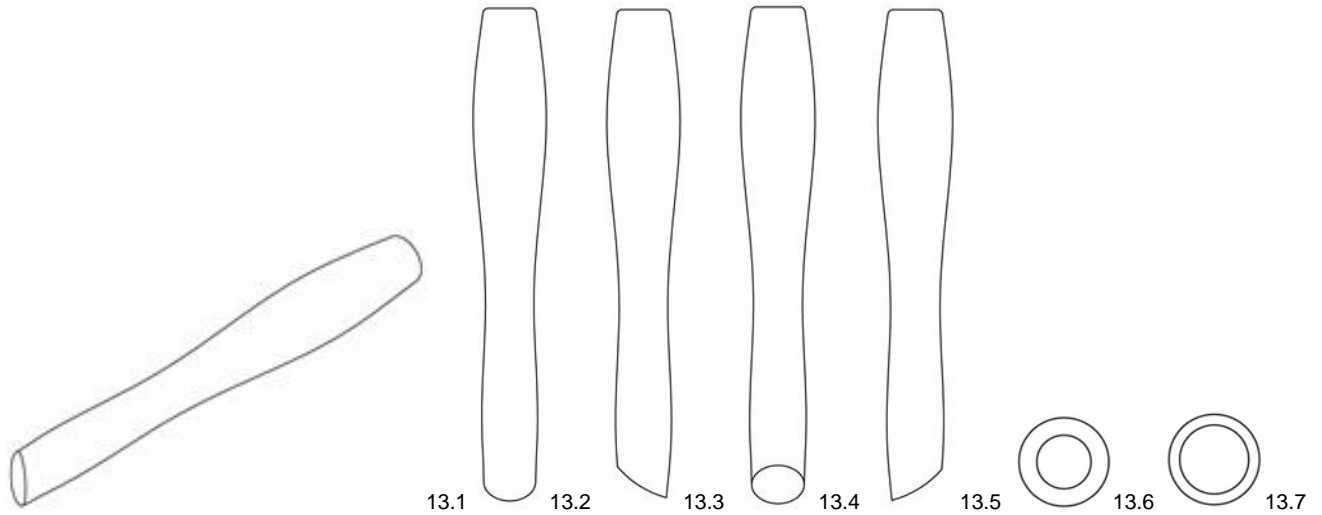
**Design 14**

- (54) **Produkt:** Hand-held aerosol generators  
 (51) **Klasse:** 27-99  
 (72) **Designer:** Jonathan Hogwood, 7 Chalkhill Barrow, SG86EQ MELBOURN, ROYSTON, HERTS, Storbritannia (GB)  
 Stuart Cooper, 6 Merle Way, CB236FE LOWER CAMBOURNE, CAMBS, Storbritannia (GB)  
 2011.12.23, EM, 001307631  
 (30) **Prioritet:**  
 (55) **Designavbildninger:**

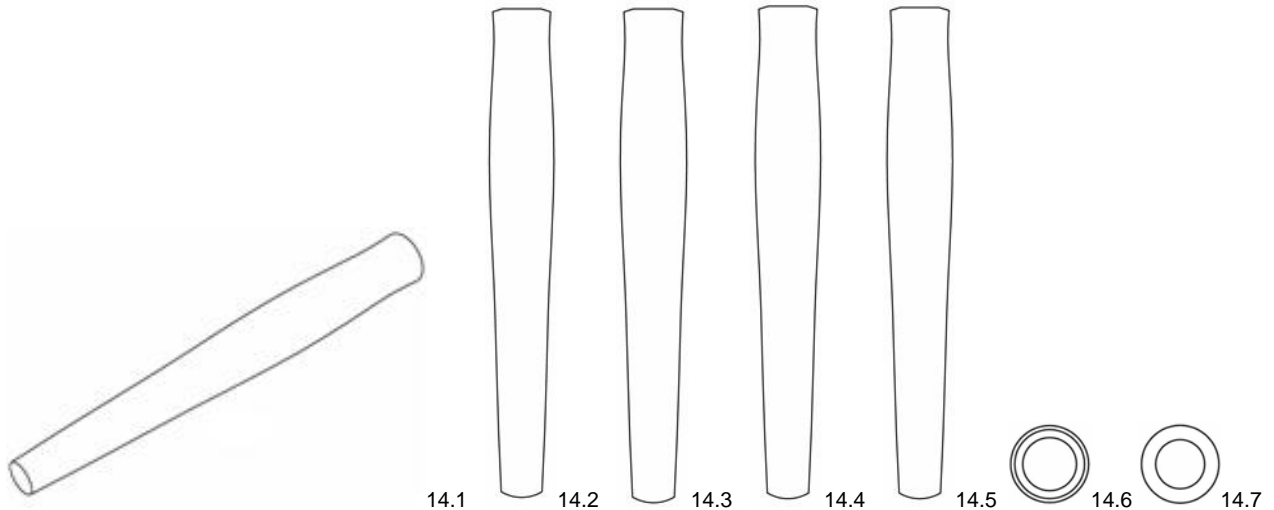

**Design 15**

- (54) **Produkt:** Hand-held aerosol generators  
(51) **Klasse:** 27-99  
(72) **Designer:** Jonathan Hogwood, 7 Chalkhill Barrow, SG86EQ MELBOURN, ROYSTON, HERTS, Storbritannia (GB)  
Stuart Cooper, 6 Merle Way, CB236FE LOWER CAMBOURNE, CAMBS, Storbritannia (GB)  
(30) **Prioritet:** 2011.12.23, EM, 001307631  
(55) **Designavbildninger:**

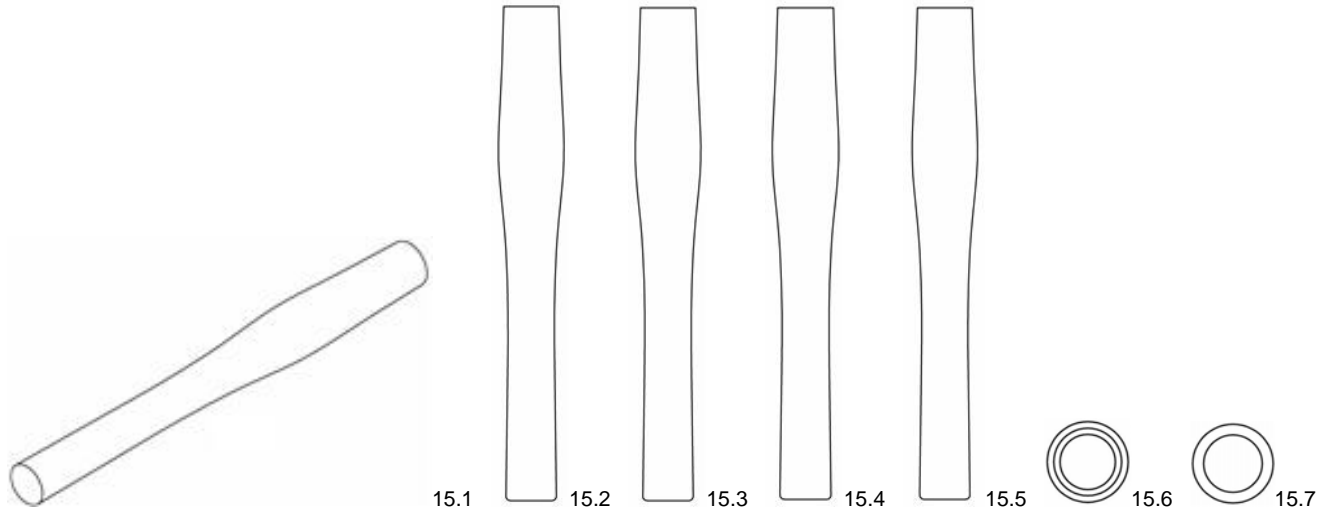
**Design 16**

- (54) **Produkt:** Hand-held aerosol generators  
(51) **Klasse:** 27-99  
(72) **Designer:** Jonathan Hogwood, 7 Chalkhill Barrow, SG86EQ MELBOURN, ROYSTON, HERTS, Storbritannia (GB)  
Stuart Cooper, 6 Merle Way, CB236FE LOWER CAMBOURNE, CAMBS, Storbritannia (GB)  
(30) **Prioritet:** 2011.12.23, EM, 001307631  
(55) **Designavbildninger:**

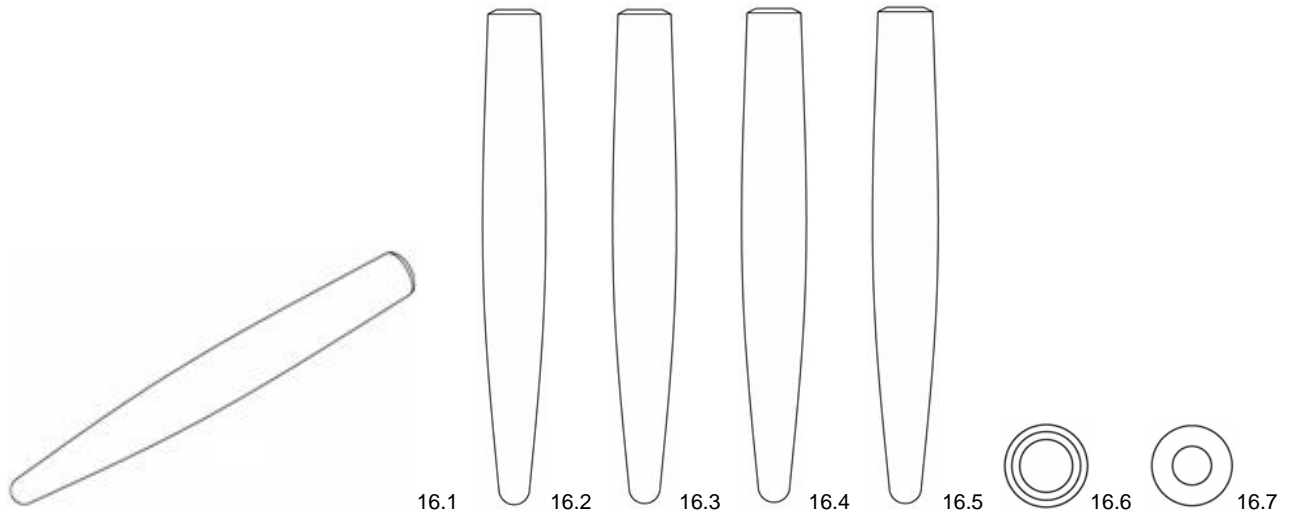

**Design 17**

- (54) **Produkt:** Hand-held aerosol generators  
 (51) **Klasse:** 27-99  
 (72) **Designer:** Jonathan Hogwood, 7 Chalkhill Barrow, SG86EQ MELBOURN, ROYSTON, HERTS, Storbritannia (GB)  
 Stuart Cooper, 6 Merle Way, CB236FE LOWER CAMBOURNE, CAMBS, Storbritannia (GB)  
 2011.12.23, EM, 001307631  
 (30) **Prioritet:**  
 (55) **Designavbildninger:**

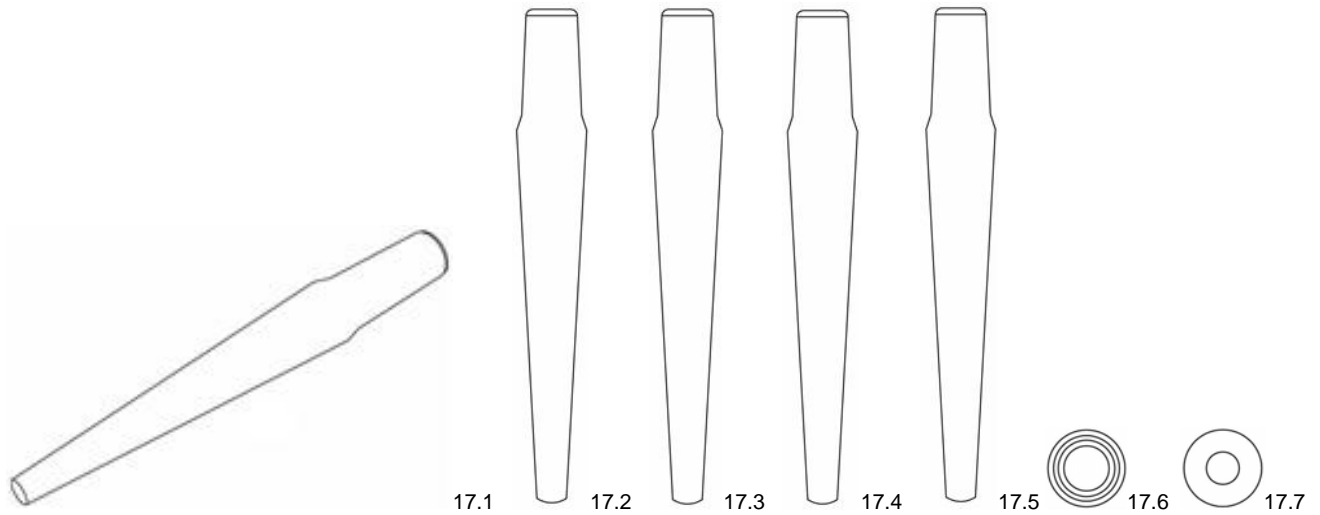
**Design 18**

- (54) **Produkt:** Hand-held aerosol generators  
 (51) **Klasse:** 27-99  
 (72) **Designer:** Jonathan Hogwood, 7 Chalkhill Barrow, SG86EQ MELBOURN, ROYSTON, HERTS, Storbritannia (GB)  
 Stuart Cooper, 6 Merle Way, CB236FE LOWER CAMBOURNE, CAMBS, Storbritannia (GB)  
 2011.12.23, EM, 001307631  
 (30) **Prioritet:**  
 (55) **Designavbildninger:**

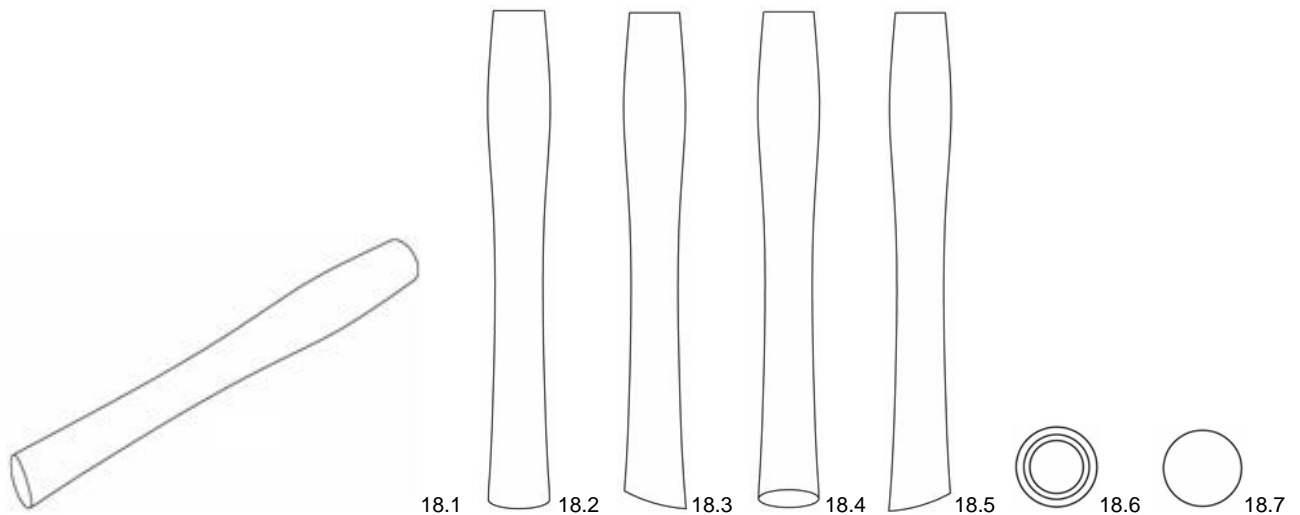



**Design 19**

(54) **Produkt:** Hand-held aerosol generators  
 (51) **Klasse:** 27-99  
 (72) **Designer:** Jonathan Hogwood, 7 Chalkhill Barrow, SG86EQ MELBOURN, ROYSTON, HERTS, Storbritannia (GB)  
 Stuart Cooper, 6 Merle Way, CB236FE LOWER CAMBOURNE, CAMBS, Storbritannia (GB)  
 2011.12.23, EM, 001307631  
 (30) **Prioritet:**  
 (55) **Designavbildninger:**

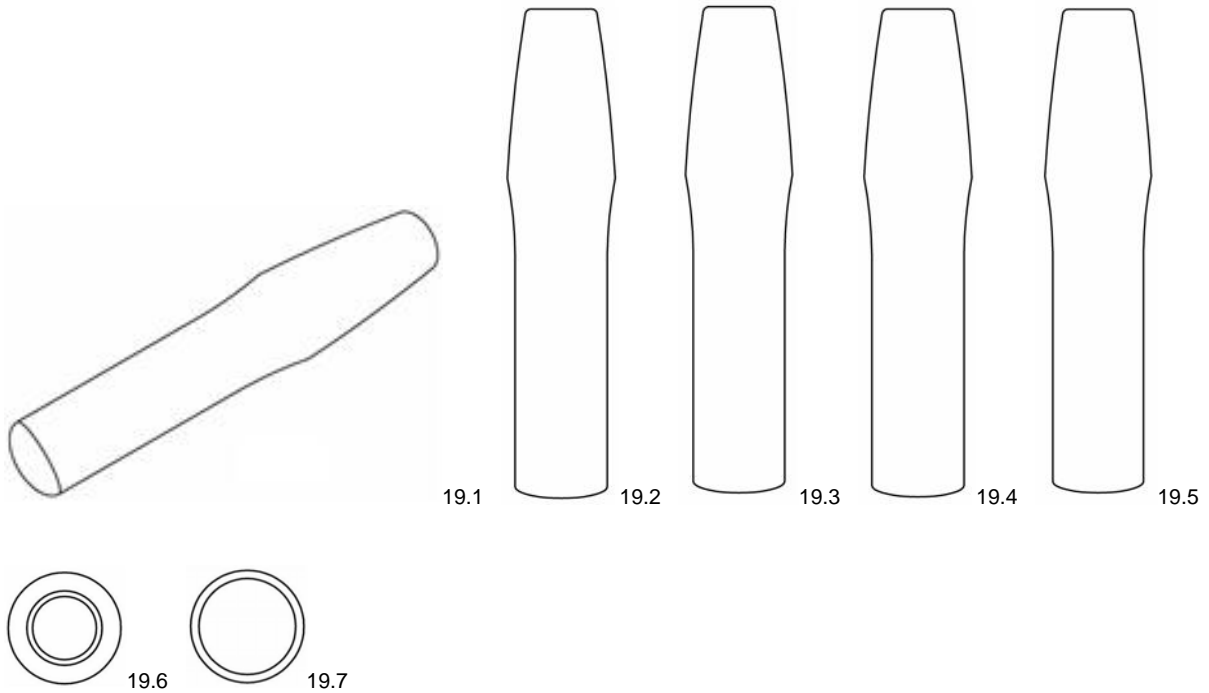

**Design 20**

(54) **Produkt:** Hand-held aerosol generators  
 (51) **Klasse:** 27-99  
 (72) **Designer:** Jonathan Hogwood, 7 Chalkhill Barrow, SG86EQ MELBOURN, ROYSTON, HERTS, Storbritannia (GB)  
 Stuart Cooper, 6 Merle Way, CB236FE LOWER CAMBOURNE, CAMBS, Storbritannia (GB)  
 2011.12.23, EM, 001307631  
 (30) **Prioritet:**  
 (55) **Designavbildninger:**

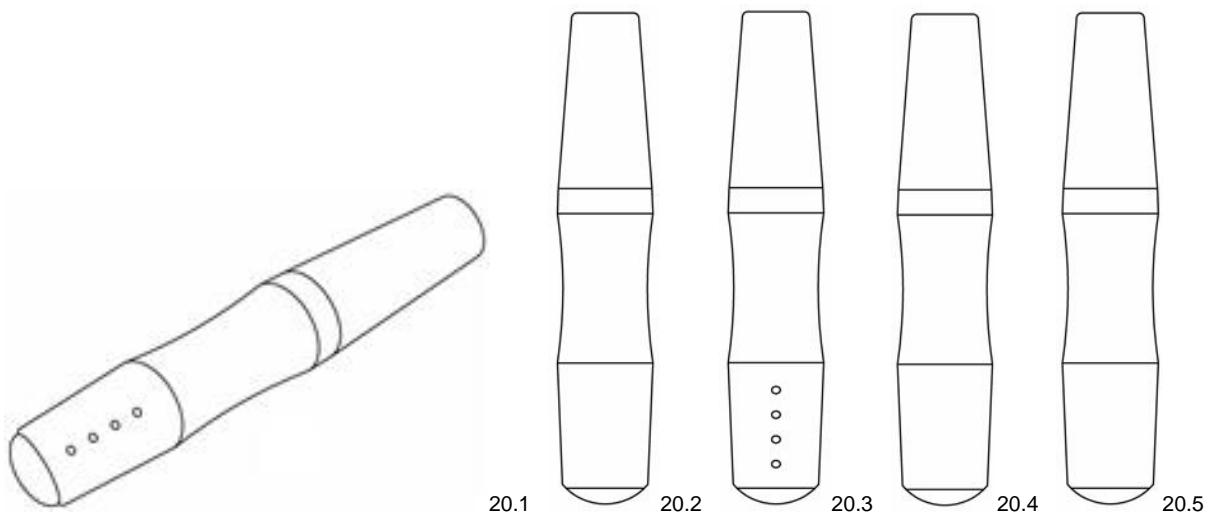



**Design 21**

(54) **Produkt:** Hand-held aerosol generators  
 (51) **Klasse:** 27-99  
 (72) **Designer:** Jonathan Hogwood, 7 Chalkhill Barrow, SG86EQ MELBOURN, ROYSTON, HERTS, Storbritannia (GB)  
 Stuart Cooper, 6 Merle Way, CB236FE LOWER CAMBOURNE, CAMBS, Storbritannia (GB)  
 (30) **Prioritet:** 2011.12.23, EM, 001307631  
 (55) **Designavbildninger:**

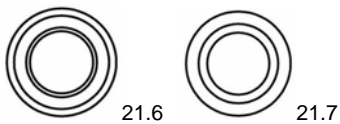
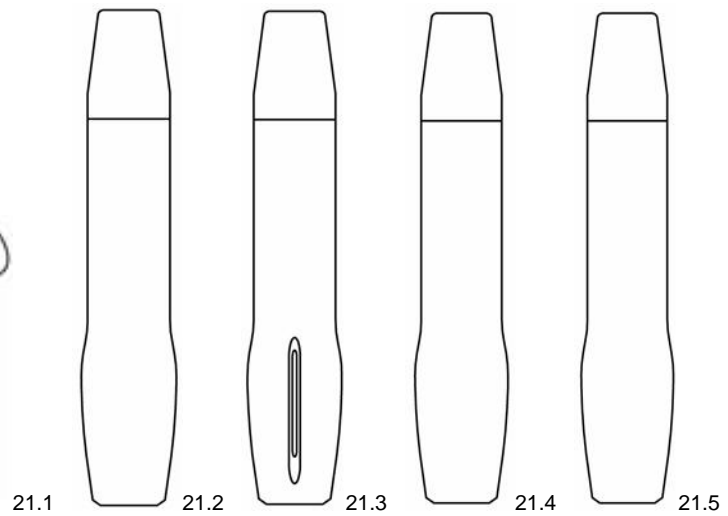
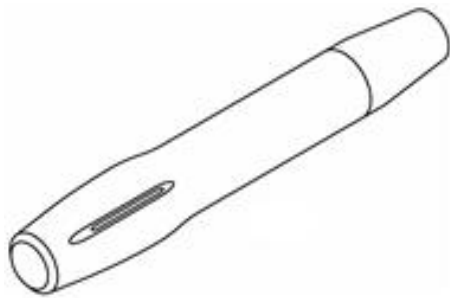

**Design 22**

(54) **Produkt:** Hand-held aerosol generators  
 (51) **Klasse:** 27-99  
 (72) **Designer:** Jonathan Hogwood, 7 Chalkhill Barrow, SG86EQ MELBOURN, ROYSTON, HERTS, Storbritannia (GB)  
 Stuart Cooper, 6 Merle Way, CB236FE LOWER CAMBOURNE, CAMBS, Storbritannia (GB)  
 2011.12.23, EM, 001307631  
 (30) **Prioritet:**  
 (55) **Designavbildninger:**

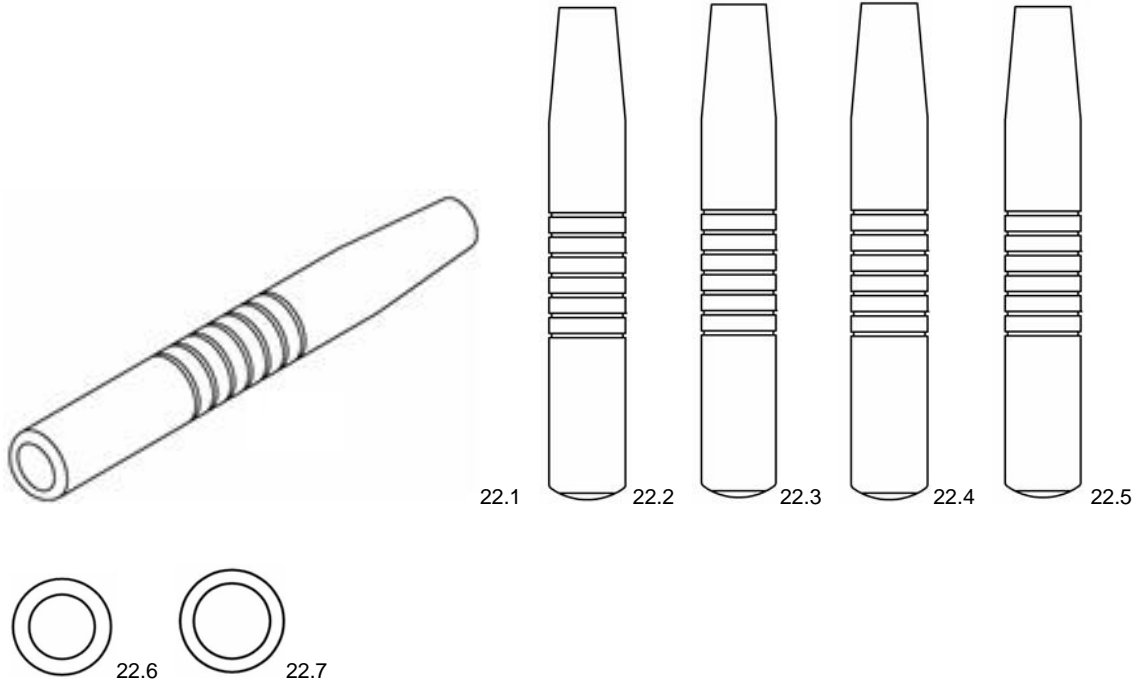

**Design 23**

(54) **Produkt:** Hand-held aerosol generators  
 (51) **Klasse:** 27-99  
 (72) **Designer:** Jonathan Hogwood, 7 Chalkhill Barrow, SG86EQ MELBOURN, ROYSTON, HERTS, Storbritannia (GB)  
 Stuart Cooper, 6 Merle Way, CB236FE LOWER CAMBOURNE, CAMBS, Storbritannia (GB)  
 2011.12.23, EM, 001307631  
 (30) **Prioritet:**  
 (55) **Designavbildninger:**

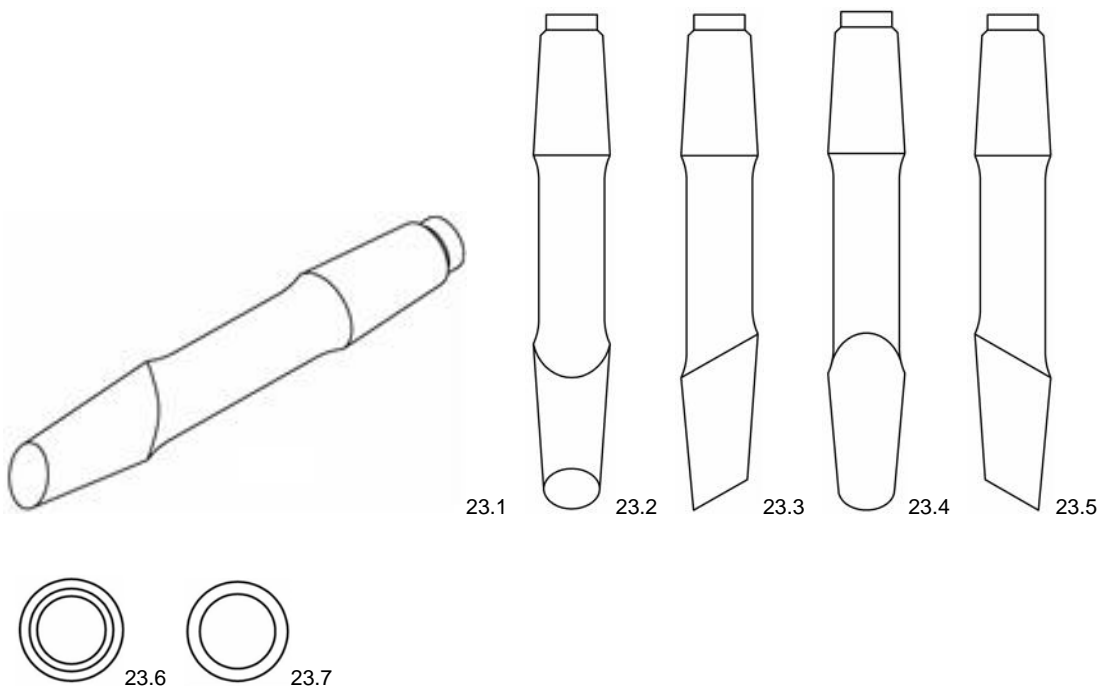

**Design 24**

(54) **Produkt:** Hand-held aerosol generators  
 (51) **Klasse:** 27-99  
 (72) **Designer:** Jonathan Hogwood, 7 Chalkhill Barrow, SG86EQ MELBOURN, ROYSTON, HERTS, Storbritannia (GB)  
 Stuart Cooper, 6 Merle Way, CB236FE LOWER CAMBOURNE, CAMBS, Storbritannia (GB)  
 2011.12.23, EM, 001307631  
 (30) **Prioritet:**  
 (55) **Designavbildninger:**

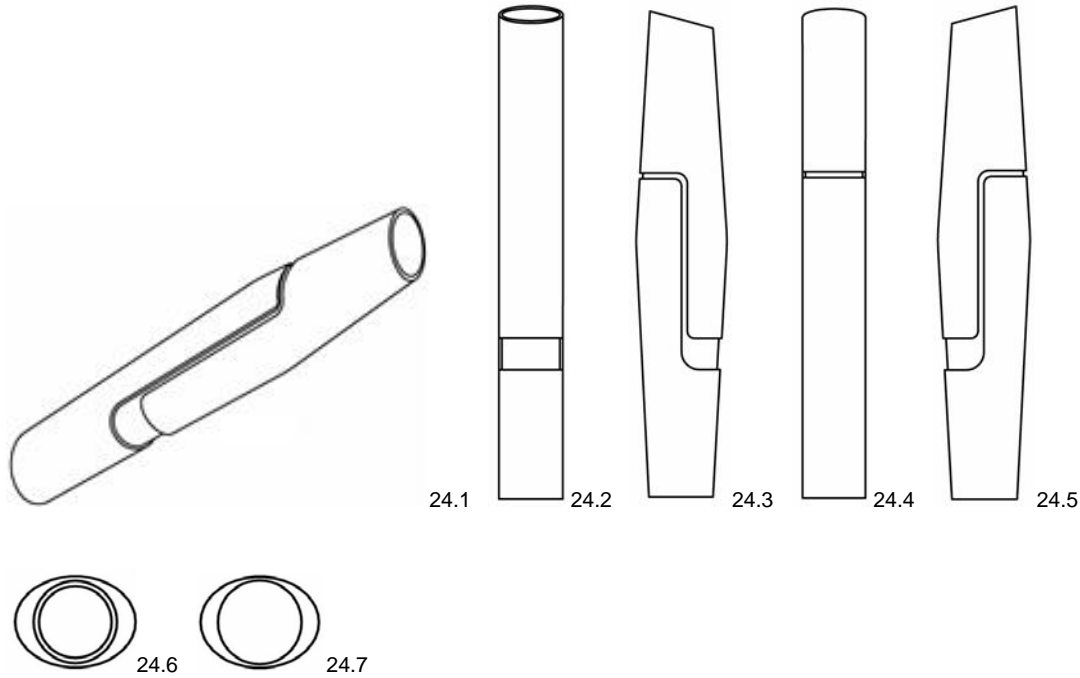

**Design 25**

(54) **Produkt:** Hand-held aerosol generators  
 (51) **Klasse:** 27-99  
 (72) **Designer:** Jonathan Hogwood, 7 Chalkhill Barrow, SG86EQ MELBOURN, ROYSTON, HERTS, Storbritannia (GB)  
 Stuart Cooper, 6 Merle Way, CB236FE LOWER CAMBOURNE, CAMBS, Storbritannia (GB)  
 2011.12.23, EM, 001307631  
 (30) **Prioritet:**  
 (55) **Designavbildninger:**

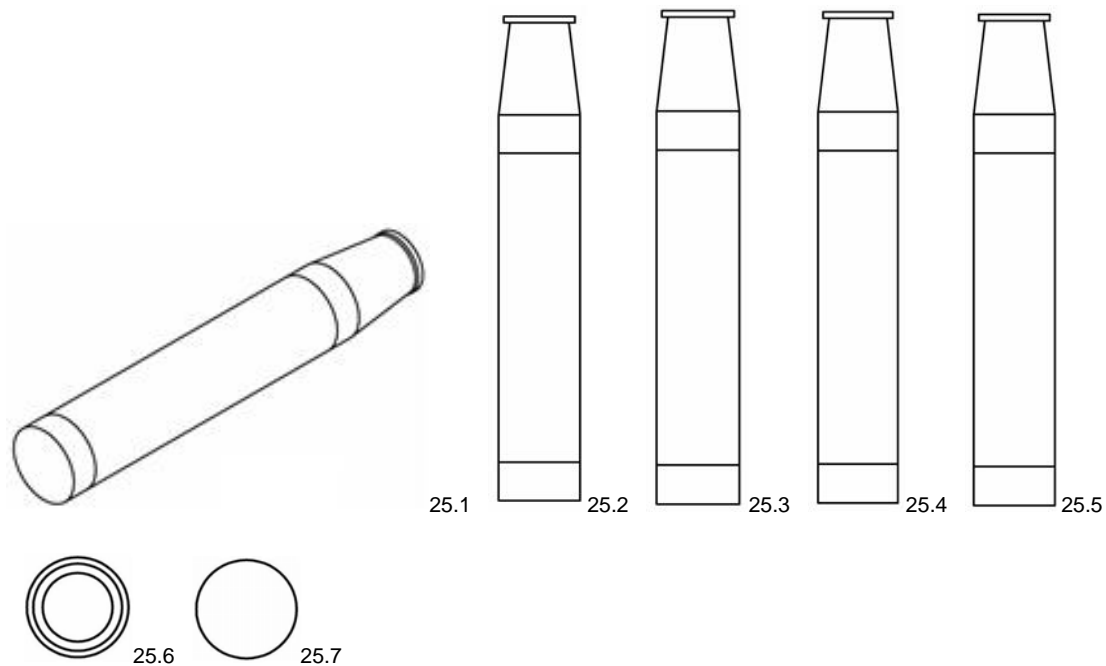

(11)	<b>Reg.nr.:</b>	<b>DM/078651</b>
(21)	<b>Søkn.nr.:</b>	20120738
(22)	<b>Inngitt:</b>	2012.06.21
(24)	<b>Løpedag:</b>	2012.06.21
(43)	<b>Allm. tilgj.:</b>	2012.12.21
(15)	<b>Registrert:</b>	2012.06.21
(45)	<b>Kunngjort:</b>	2013.02.04
(18)	<b>Reg. gjelder til:</b>	2017.06.21
(73)	<b>Innehaver:</b>	Triumph Intertrade AG, Triumphweg 6, CH-5330 BAD ZURZACH, Sveits
(50)	<b>Anmerkninger:</b>	Registreringen gjelder samregistrering.

**Design 1**

(54)	<b>Produkt:</b>	Packaging carton
(51)	<b>Klasse:</b>	09-03
(72)	<b>Designer:</b>	Anna Giandomenico, c/o Inter-Triumph Marketing GmbH, Marsstrasse 40, 80335 MÜNCHEN, Tyskland (DE)
(55)	<b>Designavbildninger:</b>	



1.1

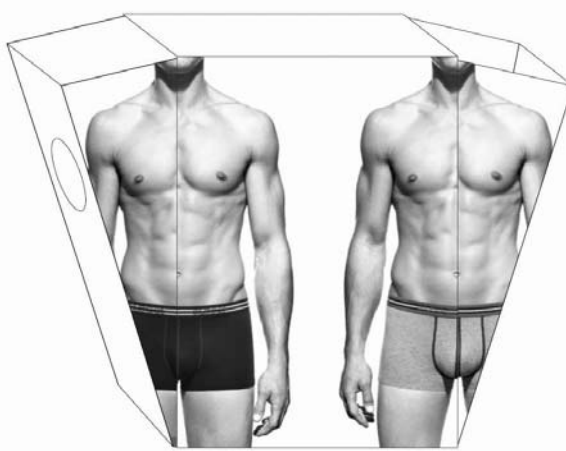

1.2



1.3

**Design 2**

- (54) **Produkt:** Set of packaging cartons  
(51) **Klasse:** 09-03  
(72) **Designer:** Anna Giandomenico, c/o Inter-Triumph Marketing GmbH, Marsstrasse 40, 80335 MÜNCHEN, Tyskland (DE)  
(55) **Designavbildninger:**

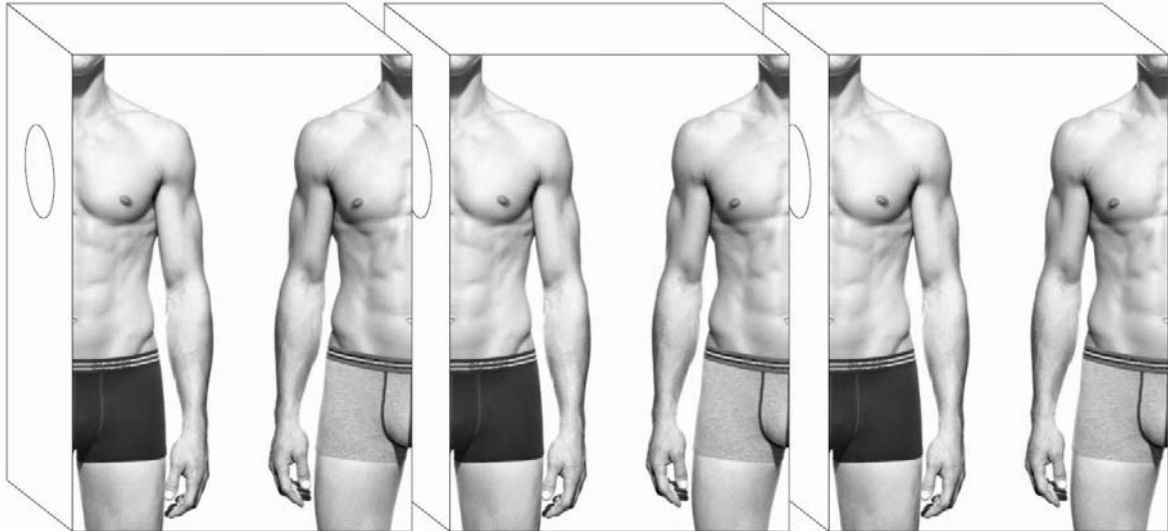

2.1

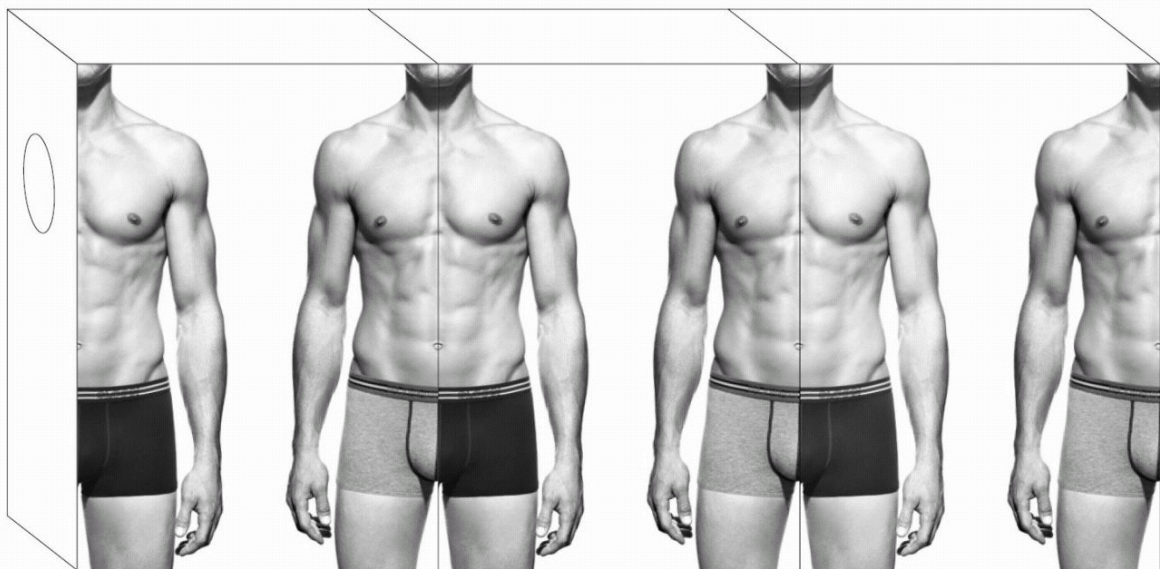

2.2

(11)	<b>Reg.nr.:</b>	<b>DM/078652</b>
(21)	<b>Søkn.nr.:</b>	20120739
(22)	<b>Inngitt:</b>	2012.03.12
(24)	<b>Løpedag:</b>	2012.06.28
(43)	<b>Allm. tilgj.:</b>	2012.12.28
(15)	<b>Registrert:</b>	2012.06.28
(45)	<b>Kunngjort:</b>	2013.02.04
(18)	<b>Reg. gjelder til:</b>	2017.06.28
(73)	<b>Innehaver:</b>	ROLEX SA, Rue Francois-Dussaud 3-5-7, CH-1211 GENÈVE 26, Sveits
(50)	<b>Anmerkninger:</b>	Registreringen gjelder samregistrering.

### Design 1

(54)	<b>Produkt:</b>	Watch dials
(51)	<b>Klasse:</b>	10-07
(72)	<b>Designer:</b>	Maria Cristina Calvani, Chemin David Munier 12, 1223 COLOGNY, Sveits (CH)
(30)	<b>Prioritet:</b>	2011.11.03, CH, 138387
(55)	<b>Designavbildninger:</b>	

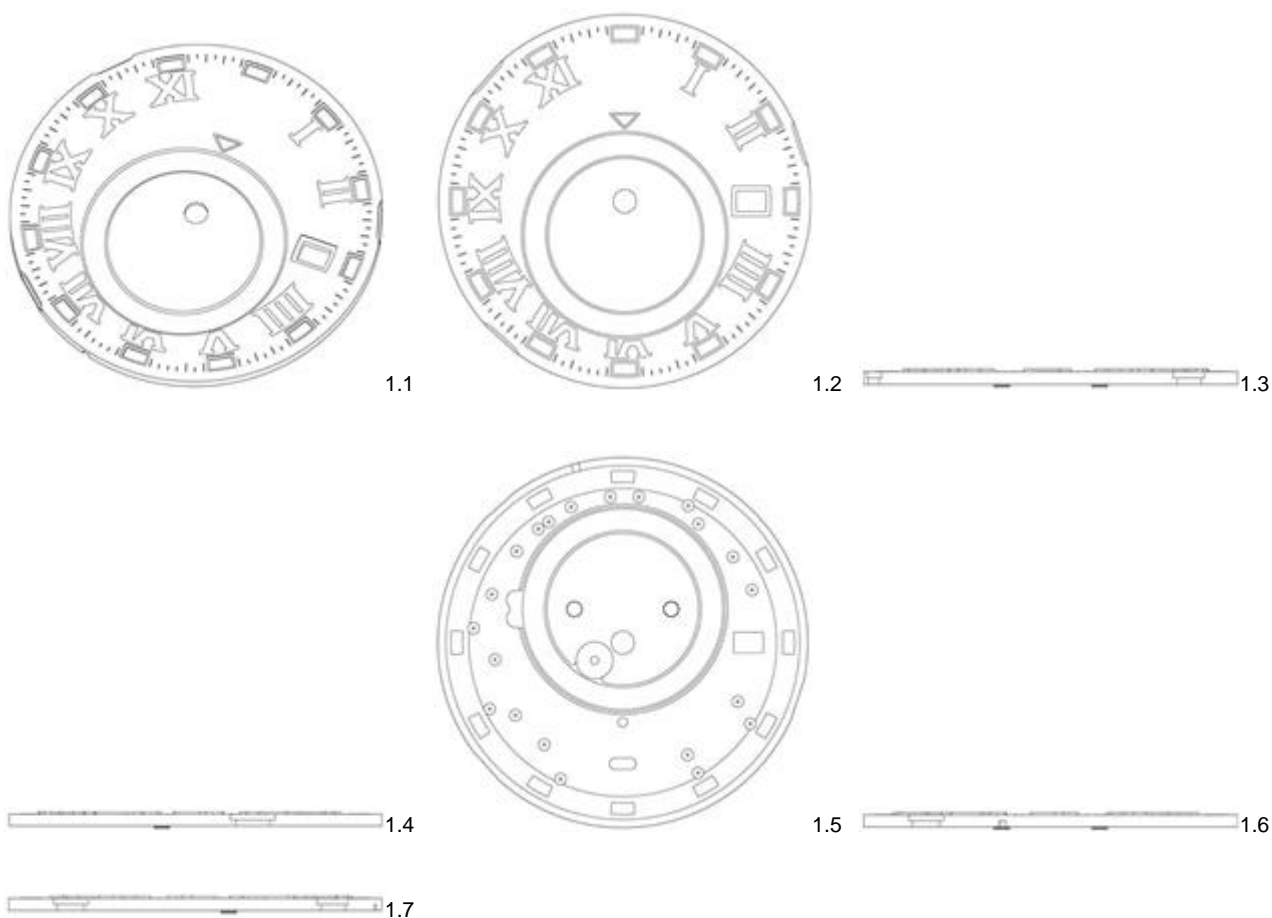

**Design 2**

(54) **Produkt:** Watch dials  
 (51) **Klasse:** 10-07  
 (72) **Designer:** Maria Cristina Calvani, Chemin David Munier 12, 1223 COLOGNY, Sveits (CH)  
 (30) **Prioritet:** 2011.11.03, CH, 138387  
 (55) **Designavbildninger:**



2.1



2.2



2.3

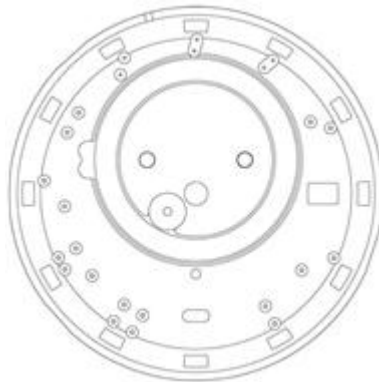

2.5



2.6



2.4



2.7

**Design 3**

(54) **Produkt:** Watch dials  
 (51) **Klasse:** 10-07  
 (72) **Designer:** Maria Cristina Calvani, Chemin David Munier 12, 1223 COLOGNY, Sveits (CH)  
 (30) **Prioritet:** 2011.11.03, CH, 138387  
 (55) **Designavbildninger:**



3.1



3.2



3.3



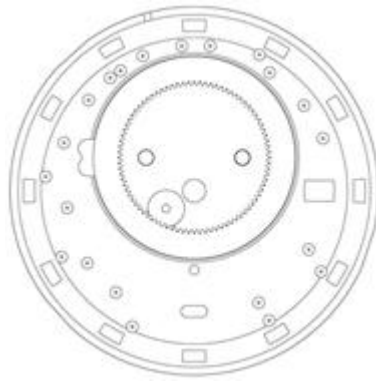

**Design 4**

- (54) **Produkt:** Watch dials
- (51) **Klasse:** 10-07
- (72) **Designer:** Maria Cristina Calvani, Chemin David Munier 12, 1223 COLOGNY, Sveits (CH)
- (30) **Prioritet:** 2011.11.03, CH, 138387
- (55) **Designavbildninger:**



4.1



4.4

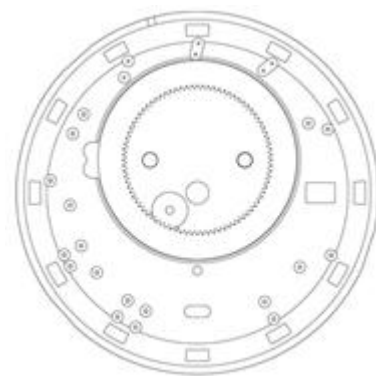

4.7

**Design 5**

(54) **Produkt:** Watches  
(51) **Klasse:** 10-02  
(72) **Designer:** Maria Cristina Calvani, Chemin David Munier 12, 1223 COLOGNY, Sveits (CH)  
(30) **Prioritet:** 2011.11.03, CH, 138387  
(55) **Designavbildninger:**



5.1



5.2



5.3

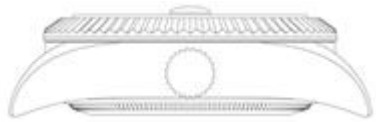

5.4



5.5

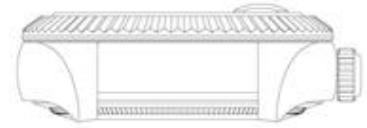

5.6

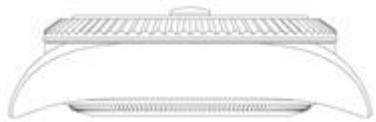

5.7

**Design 6**

(54) **Produkt:** Watches  
(51) **Klasse:** 10-02  
(72) **Designer:** Maria Cristina Calvani, Chemin David Munier 12, 1223 COLOGNY, Sveits (CH)  
(30) **Prioritet:** 2011.11.03, CH, 138387  
(55) **Designavbildninger:**



6.1



6.2



6.3

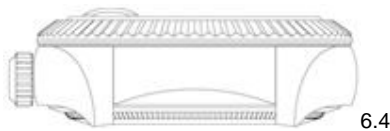

6.4



6.5

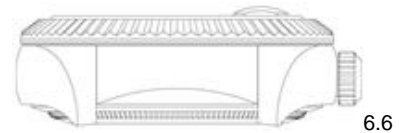

6.6



6.7

(11)	<b>Reg.nr.:</b>	<b>DM/078790</b>
(21)	<b>Søkn.nr.:</b>	20120807
(22)	<b>Inngitt:</b>	2012.07.05
(24)	<b>Løpedag:</b>	2012.07.05
(43)	<b>Allm. tilgj.:</b>	2013.01.11
(15)	<b>Registrert:</b>	2012.07.05
(45)	<b>Kunngjort:</b>	2013.02.04
(18)	<b>Reg. gjelder til:</b>	2017.07.05
(73)	<b>Innehaver:</b>	Mascot A/S, Julsovej 100, DK-8600 SILKEBORG, Danmark

## Design 1

(54)	<b>Produkt:</b>	Trousers
(51)	<b>Klasse:</b>	02-02
(72)	<b>Designer:</b>	Michael Grosbøl, Julsøvy 100, 8600 SILKEBORG, Danmark (DK)
(30)	<b>Prioritet:</b>	2012.03.30, EM, 002017798
(55)	<b>Designavbildninger:</b>	

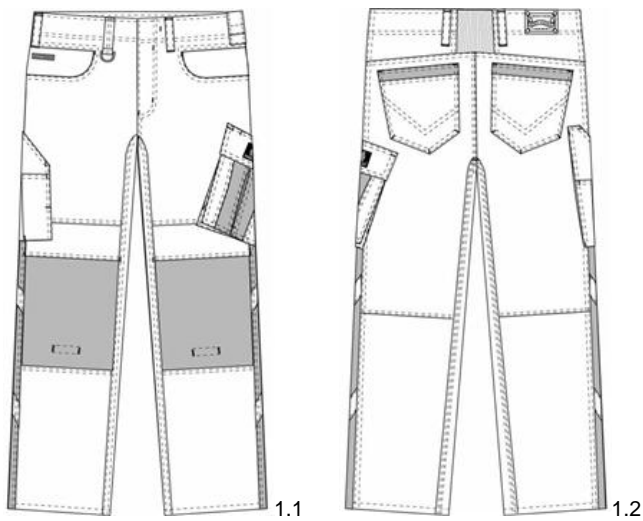

- (11) **Reg.nr.:** DM/078815  
(21) **Søkn.nr.:** 20120815  
(22) **Inngitt:** 2012.07.04  
(24) **Løpedag:** 2012.07.04  
(43) **Allm. tilgj.:** 2013.01.04  
(15) **Registrert:** 2012.07.04  
(45) **Kunngjort:** 2013.02.04  
(18) **Reg. gjelder til:** 2017.07.04  
(73) **Innehaver:** Soremartec SA, Rue Joseph Netzer 5, BE-6700 ARLON, Belgia  
(50) **Anmerkninger:** Registreringen gjelder samregistrering.

**Design 1**

- (54) **Produkt:** Jars for food product  
(51) **Klasse:** 09-03  
(72) **Designer:** Marco Rosella, Via Raddusa 13, 10098 RIVOLI (TORINO), Italia (IT)  
(30) **Prioritet:** 2012.06.27, IN, 246253, 1  
(55) **Designavbildninger:**

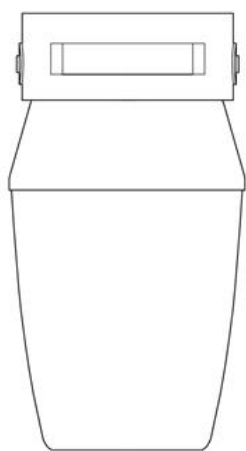

1.1

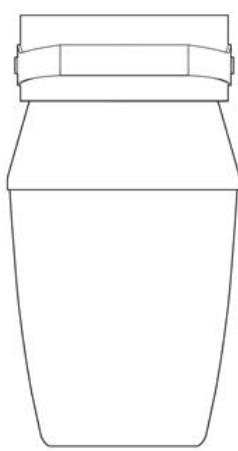

1.2



1.3

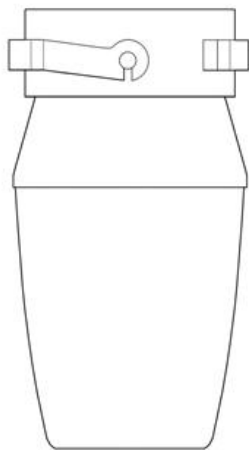

1.4

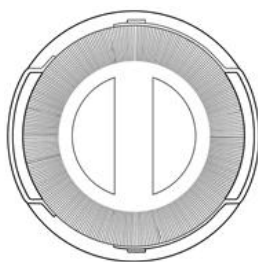

1.5

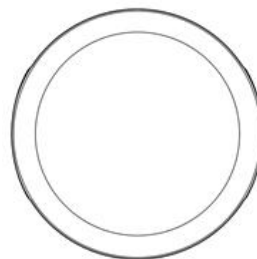

1.6



1.7

**Design 2**

(54)	<b>Produkt:</b>	Jars for food product
(51)	<b>Klasse:</b>	09-03
(72)	<b>Designer:</b>	Marco Rosella, Via Raddusa 13, 10098 RIVOLI (TORINO), Italia (IT)
(30)	<b>Prioritet:</b>	2012.06.27, IN, 246254, 2
(55)	<b>Designavbildninger:</b>	

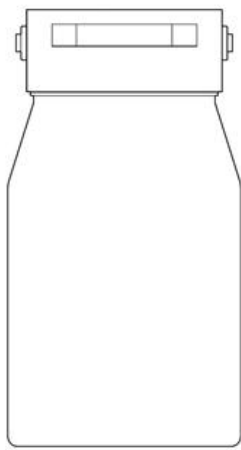

2.1

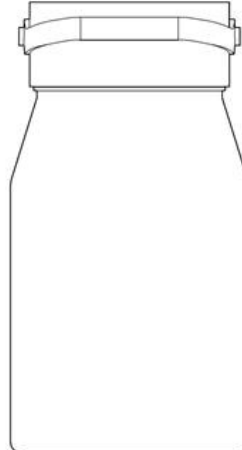

2.2

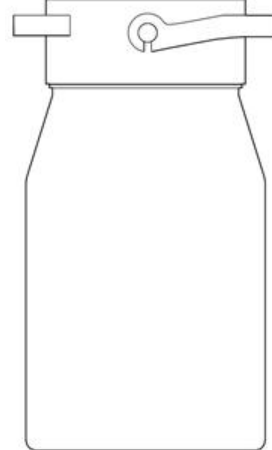

2.3

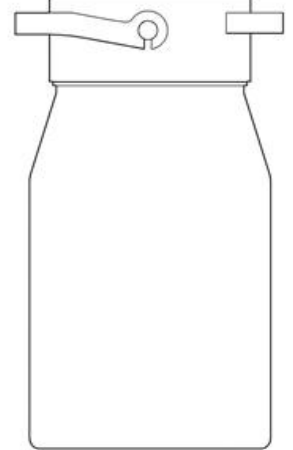

2.4

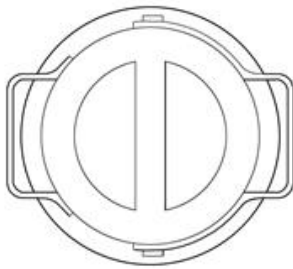

2.5

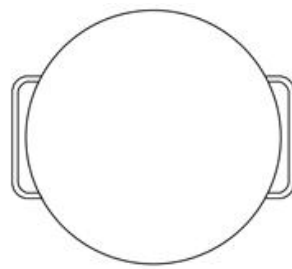

2.6

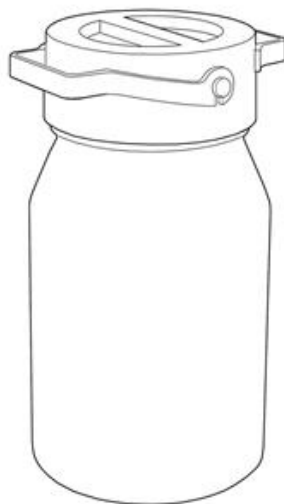

2.7

**Design 3**

(54) **Produkt:** Jars for food product  
 (51) **Klasse:** 09-03  
 (72) **Designer:** Marco Rosella, Via Raddusa 13, 10098 RIVOLI (TORINO), Italia (IT)  
 (30) **Prioritet:** 2012.06.27, IN, 246255, 3  
 (55) **Designavbildninger:**

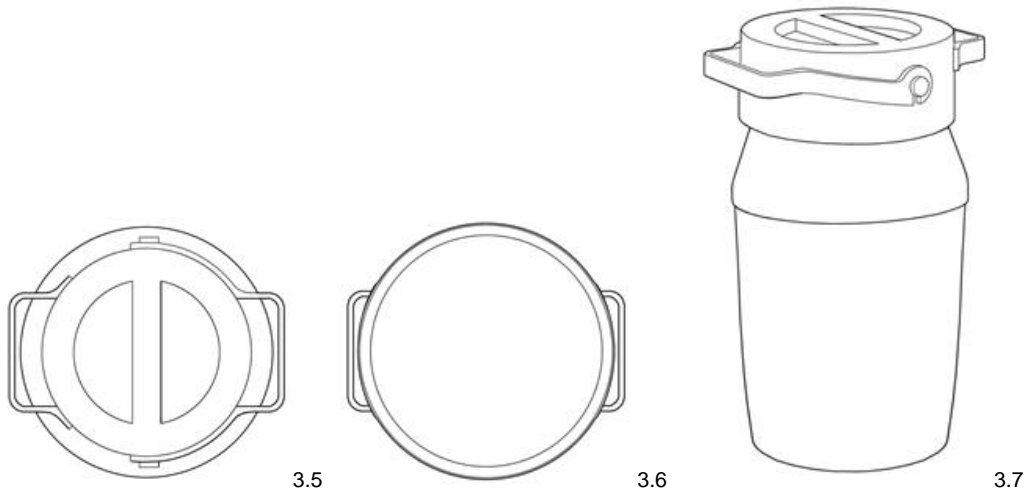
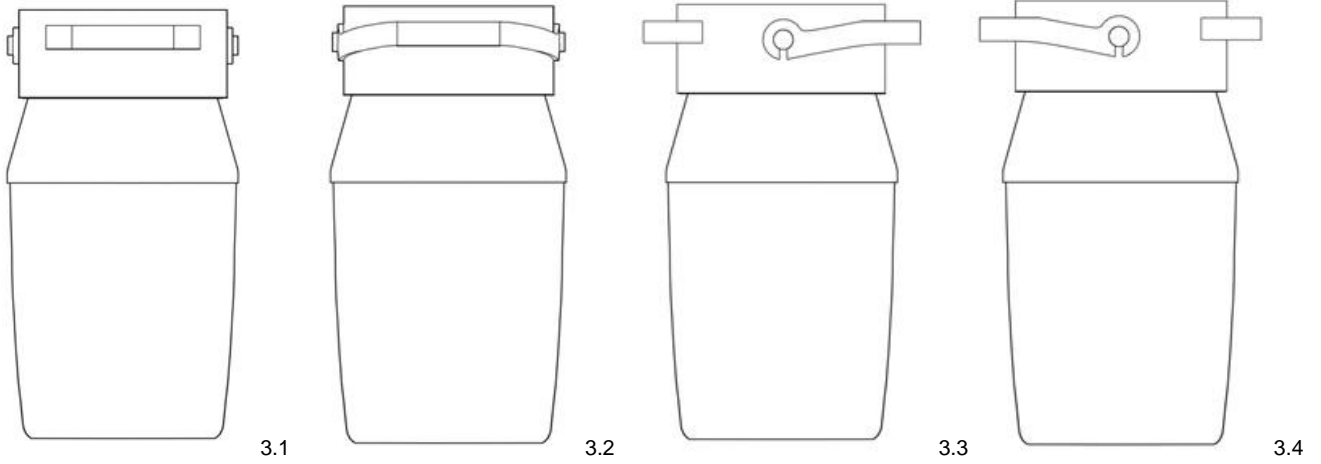

**Design 4**

(54) **Produkt:** Jars for food product  
 (51) **Klasse:** 09-03  
 (72) **Designer:** Marco Rosella, Via Raddusa 13, 10098 RIVOLI (TORINO), Italia (IT)  
 (55) **Designavbildninger:**

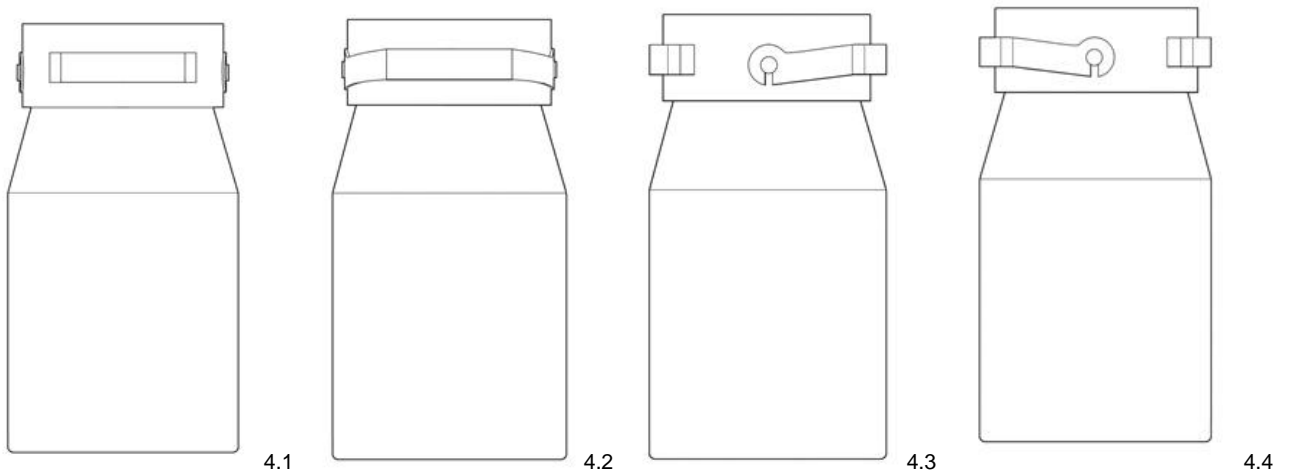

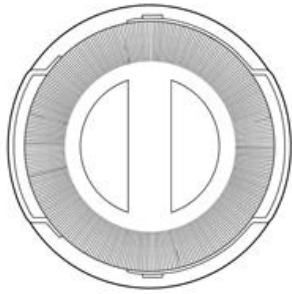

4.5

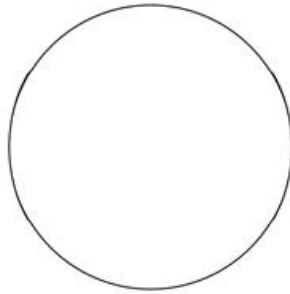

4.6

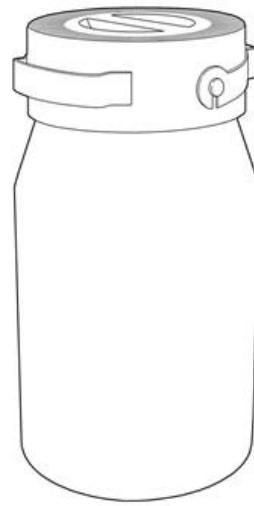

4.7



(11)	<b>Reg.nr.:</b>	<b>DM/078901</b>
(21)	<b>Søkn.nr.:</b>	20120832
(22)	<b>Inngitt:</b>	2012.08.09
(24)	<b>Løpedag:</b>	2012.08.09
(43)	<b>Allm. tilgj.:</b>	2012.08.24
(15)	<b>Registrert:</b>	2012.08.09
(45)	<b>Kunngjort:</b>	2013.02.04
(18)	<b>Reg. gjelder til:</b>	2017.08.09
(73)	<b>Innehaver:</b>	Automobili Lamborghini SpA, Via Modena, 12, IT-40019 SANT'AGATA BOLOGNESE (BO), Italia

**Design 1**

(54)	<b>Produkt:</b>	Motor vehicle
(51)	<b>Klasse:</b>	12-08
(30)	<b>Prioritet:</b>	2012.02.10, EM, 001989781
(55)	<b>Designavbildninger:</b>	



1.1



1.2



1.3



1.4



1.5



1.6



1.7

- (11) **Reg.nr.:** DM/078926  
(21) **Søkn.nr.:** 20120836  
(22) **Inngitt:** 2012.06.18  
(24) **Løpedag:** 2012.06.18  
(43) **Allm. tilgj.:** 2012.12.21  
(15) **Registrert:** 2012.06.18  
(45) **Kunngjort:** 2013.02.04  
(18) **Reg. gjelder til:** 2017.06.18  
(73) **Innehaver:** Thomas Sabo GmbH & Co Schmuckhandel KG, Martin-Luther-Strasse 20 , DE-91207 LAUF AN DER PEGNITZ, Tyskland  
(50) **Anmerkninger:** Registreringen gjelder samregistrering.

### Design 1

- (54) **Produkt:** Jewelry  
(51) **Klasse:** 11-01  
(72) **Designer:** Susanne Kölbl, Friedrichstr. 59, 60323 FRANKFURT A.M., Tyskland (DE)  
(55) **Designavbildninger:**



1.1

### Design 2

- (54) **Produkt:** Jewelry  
(51) **Klasse:** 11-01  
(72) **Designer:** Susanne Kölbl, Friedrichstr. 59, 60323 FRANKFURT A.M., Tyskland (DE)  
(55) **Designavbildninger:**



2.1

**Design 3**

(54)	<b>Produkt:</b>	Jewelry
(51)	<b>Klasse:</b>	11-01
(72)	<b>Designer:</b>	Susanne Kölbl, Friedrichstr. 59, 60323 FRANKFURT A.M., Tyskland (DE)
(55)	<b>Designavbildninger:</b>	



3.1

**Design 4**

(54)	<b>Produkt:</b>	Jewelry
(51)	<b>Klasse:</b>	11-01
(72)	<b>Designer:</b>	Susanne Kölbl, Friedrichstr. 59, 60323 FRANKFURT A.M., Tyskland (DE)
(55)	<b>Designavbildninger:</b>	



4.1

**Design 5**

(54)	<b>Produkt:</b>	Jewelry
(51)	<b>Klasse:</b>	11-01
(72)	<b>Designer:</b>	Susanne Kölbl, Friedrichstr. 59, 60323 FRANKFURT A.M., Tyskland (DE)
(55)	<b>Designavbildninger:</b>	



5.1

**Design 6**

- (54) **Produkt:** Jewelry  
(51) **Klasse:** 11-01  
(72) **Designer:** Susanne Köbli, Friedrichstr. 59, 60323 FRANKFURT A.M., Tyskland (DE)  
(55) **Designavbildninger:**

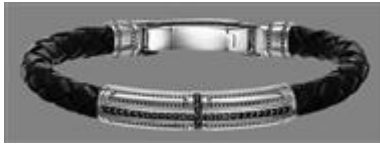

6.1

**Design 7**

- (54) **Produkt:** Jewelry  
(51) **Klasse:** 11-01  
(72) **Designer:** Susanne Köbli, Friedrichstr. 59, 60323 FRANKFURT A.M., Tyskland (DE)  
(55) **Designavbildninger:**



7.1

**Design 8**

- (54) **Produkt:** Jewelry  
(51) **Klasse:** 11-01  
(72) **Designer:** Susanne Köbli, Friedrichstr. 59, 60323 FRANKFURT A.M., Tyskland (DE)  
(55) **Designavbildninger:**



8.1

**Design 9**

(54)	<b>Produkt:</b>	Jewelry
(51)	<b>Klasse:</b>	11-01
(72)	<b>Designer:</b>	Susanne Kölbl, Friedrichstr. 59, 60323 FRANKFURT A.M., Tyskland (DE)
(55)	<b>Designavbildninger:</b>	



9.1

**Design 10**

(54)	<b>Produkt:</b>	Jewelry
(51)	<b>Klasse:</b>	11-01
(72)	<b>Designer:</b>	Susanne Kölbl, Friedrichstr. 59, 60323 FRANKFURT A.M., Tyskland (DE)
(55)	<b>Designavbildninger:</b>	



10.1

**Design 11**

(54)	<b>Produkt:</b>	Jewelry
(51)	<b>Klasse:</b>	11-01
(72)	<b>Designer:</b>	Susanne Kölbl, Friedrichstr. 59, 60323 FRANKFURT A.M., Tyskland (DE)
(55)	<b>Designavbildninger:</b>	



11.1

**Design 12**

(54) **Produkt:** Jewelry  
(51) **Klasse:** 11-01  
(72) **Designer:** Susanne Kölbl, Friedrichstr. 59, 60323 FRANKFURT A.M., Tyskland (DE)  
(55) **Designavbildninger:**



12.1

**Design 13**

(54) **Produkt:** Jewelry  
(51) **Klasse:** 11-01  
(72) **Designer:** Susanne Kölbl, Friedrichstr. 59, 60323 FRANKFURT A.M., Tyskland (DE)  
(55) **Designavbildninger:**



13.1

**Design 14**

(54) **Produkt:** Jewelry  
(51) **Klasse:** 11-01  
(72) **Designer:** Susanne Kölbl, Friedrichstr. 59, 60323 FRANKFURT A.M., Tyskland (DE)  
(55) **Designavbildninger:**



14.1

**Design 15**

- (54) **Produkt:** Jewelry  
(51) **Klasse:** 11-01  
(72) **Designer:** Susanne Kölbl, Friedrichstr. 59, 60323 FRANKFURT A.M., Tyskland (DE)  
(55) **Designavbildninger:**



15.1

**Design 16**

- (54) **Produkt:** Jewelry  
(51) **Klasse:** 11-01  
(72) **Designer:** Susanne Kölbl, Friedrichstr. 59, 60323 FRANKFURT A.M., Tyskland (DE)  
(55) **Designavbildninger:**



16.1



**Design 17**

(54)	<b>Produkt:</b>	Jewelry
(51)	<b>Klasse:</b>	11-01
(72)	<b>Designer:</b>	Susanne Kölbl, Friedrichstr. 59, 60323 FRANKFURT A.M., Tyskland (DE)
(55)	<b>Designavbildninger:</b>	



17.1

**Design 18**

(54)	<b>Produkt:</b>	Jewelry
(51)	<b>Klasse:</b>	11-01
(72)	<b>Designer:</b>	Susanne Kölbl, Friedrichstr. 59, 60323 FRANKFURT A.M., Tyskland (DE)
(55)	<b>Designavbildninger:</b>	



18.1

**Design 19**

(54)	<b>Produkt:</b>	Jewelry
(51)	<b>Klasse:</b>	11-01
(72)	<b>Designer:</b>	Susanne Kölbl, Friedrichstr. 59, 60323 FRANKFURT A.M., Tyskland (DE)
(55)	<b>Designavbildninger:</b>	



19.1

**Design 20**

(54)	<b>Produkt:</b>	Jewelry
(51)	<b>Klasse:</b>	11-01
(72)	<b>Designer:</b>	Susanne Köbli, Friedrichstr. 59, 60323 FRANKFURT A.M., Tyskland (DE)
(55)	<b>Designavbildninger:</b>	



20.1

**Design 21**

(54)	<b>Produkt:</b>	Jewelry
(51)	<b>Klasse:</b>	11-01
(72)	<b>Designer:</b>	Susanne Köbli, Friedrichstr. 59, 60323 FRANKFURT A.M., Tyskland (DE)
(55)	<b>Designavbildninger:</b>	

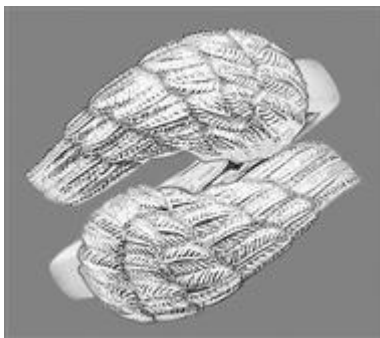

21.1

(11)	<b>Reg.nr.:</b>	<b>DM/079026</b>
(21)	<b>Søkn.nr.:</b>	20120911
(22)	<b>Inngitt:</b>	2012.06.26
(24)	<b>Løpedag:</b>	2012.06.26
(43)	<b>Allm. tilgj.:</b>	2012.12.28
(15)	<b>Registrert:</b>	2012.06.26
(45)	<b>Kunngjort:</b>	2013.02.04
(18)	<b>Reg. gjelder til:</b>	2017.06.26
(73)	<b>Innehaver:</b>	Hagfors Vågstål AB, Hästfallsvägen 21, SE-68050 EKSHÄRAD, Sverige
(50)	<b>Anmerkninger:</b>	Registreringen gjelder samregistrering.

**Design 1**

(54)	<b>Produkt:</b>	Grader snowplow blades
(51)	<b>Klasse:</b>	12-16
(72)	<b>Designer:</b>	Anders Lindgren, Klarälvsvägen 17, 68050 EKSHÄRAD, Sverige (SE)
(55)	<b>Designavbildninger:</b>	

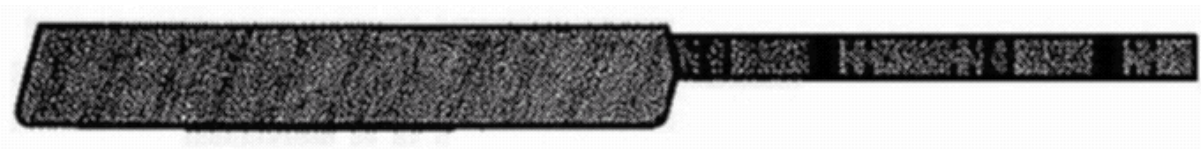
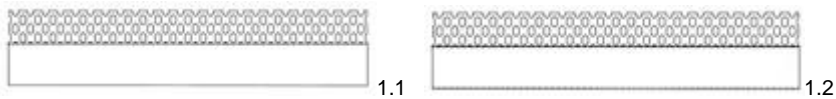

1.3

**Design 2**

(54)	<b>Produkt:</b>	Grader snowplow blades
(51)	<b>Klasse:</b>	12-16
(72)	<b>Designer:</b>	Anders Lindgren, Klarälvsvägen 17, 68050 EKSHÄRAD, Sverige (SE)
(55)	<b>Designavbildninger:</b>	

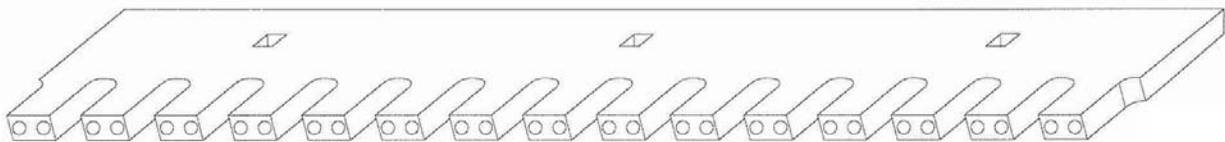

2.1

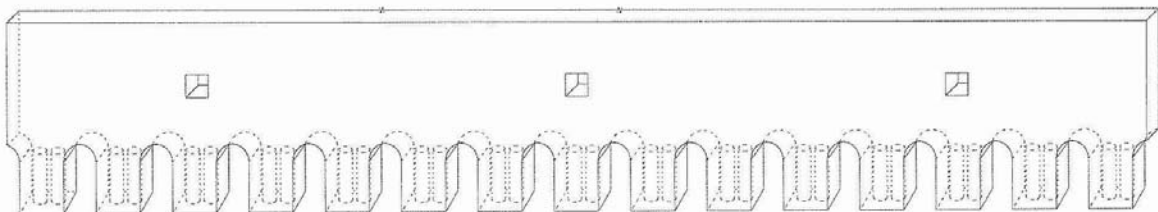

2.2

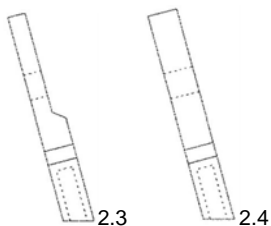

**Design 3**

- (54) **Produkt:** Grader snowplow blades  
(51) **Klasse:** 12-16  
(72) **Designer:** Anders Lindgren, Klarälvsvägen 17, 68050 EKSHÄRAD, Sverige (SE)  
(55) **Designavbildninger:**

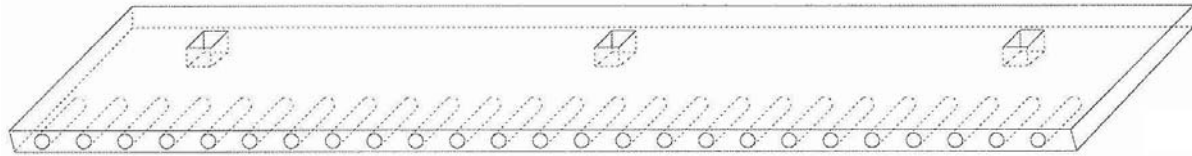

3.1

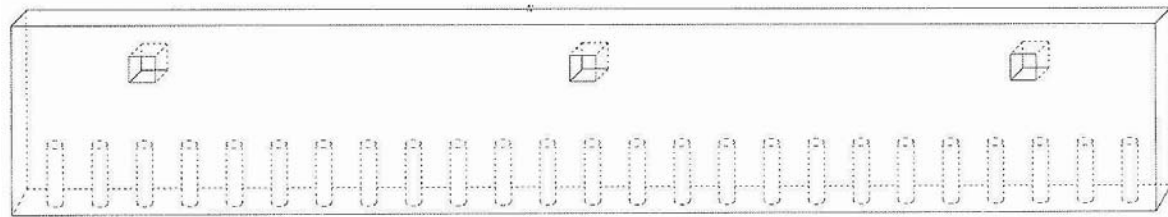

3.2

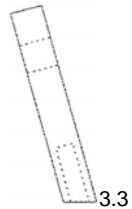

3.3

(11)	<b>Reg.nr.:</b>	<b>DM/079112</b>
(21)	<b>Søkn.nr.:</b>	20120902
(22)	<b>Inngitt:</b>	2012.06.21
(24)	<b>Løpedag:</b>	2012.06.21
(43)	<b>Allm. tilgj.:</b>	2012.12.21
(15)	<b>Registrert:</b>	2012.06.21
(45)	<b>Kunngjort:</b>	2013.02.04
(18)	<b>Reg. gjelder til:</b>	2017.06.21
(73)	<b>Innehaver:</b>	Philip Morris Products SA, Quai Jeanrenaud 3, CH-2000 NEUCHÂTEL , Sveits
(50)	<b>Anmerkninger:</b>	Registreringen gjelder samregistrering.

**Design 1**

(54)	<b>Produkt:</b>	Hand-held aerosol generators
(51)	<b>Klasse:</b>	27-99
(72)	<b>Designer:</b>	Aaron Abroff, 117 Hosmer St., MA01720 ACTON, USA (US)
(30)	<b>Prioritet:</b>	2011.12.23, EM, 001307656
(55)	<b>Designavbildninger:</b>	

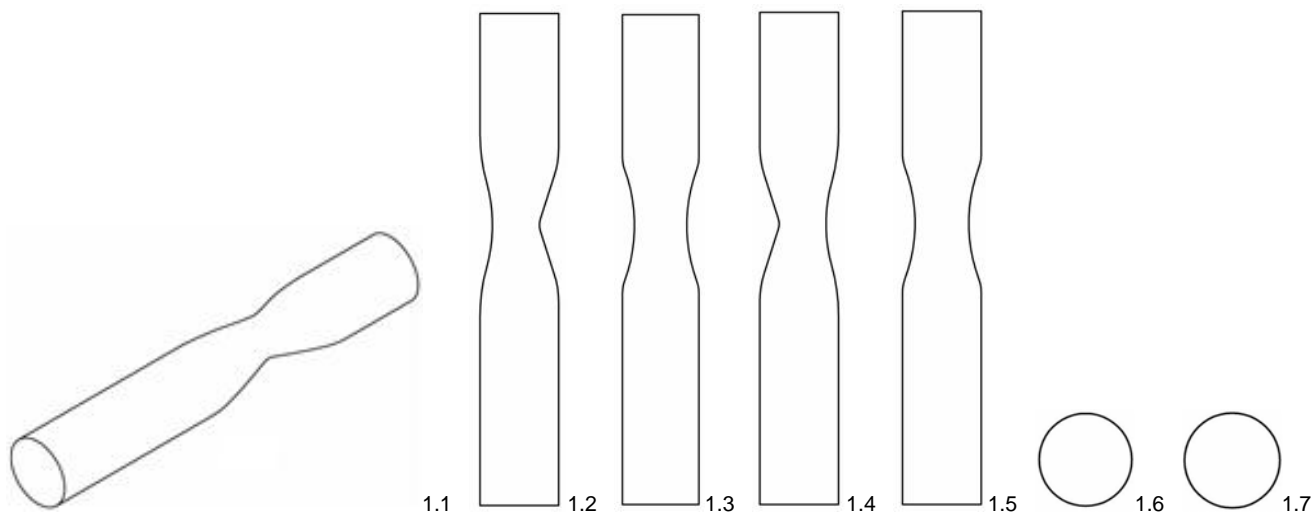
**Design 2**

(54)	<b>Produkt:</b>	Hand-held aerosol generators
(51)	<b>Klasse:</b>	27-99
(72)	<b>Designer:</b>	Jonathan Hogwood, 7 Chalkhill Barrow, SG86EQ MELBOURN, ROYSTON, HERTS, Storbritannia (GB) Aaron Abroff, 117 Hosmer St., MA01720 ACTON, USA (US) Stuart Cooper, 6 Merle Way, CB236FE LOWER CAMBOURNE, CAMBS, Storbritannia (GB)
(30)	<b>Prioritet:</b>	2011.12.23, EM, 001307656
(55)	<b>Designavbildninger:</b>	

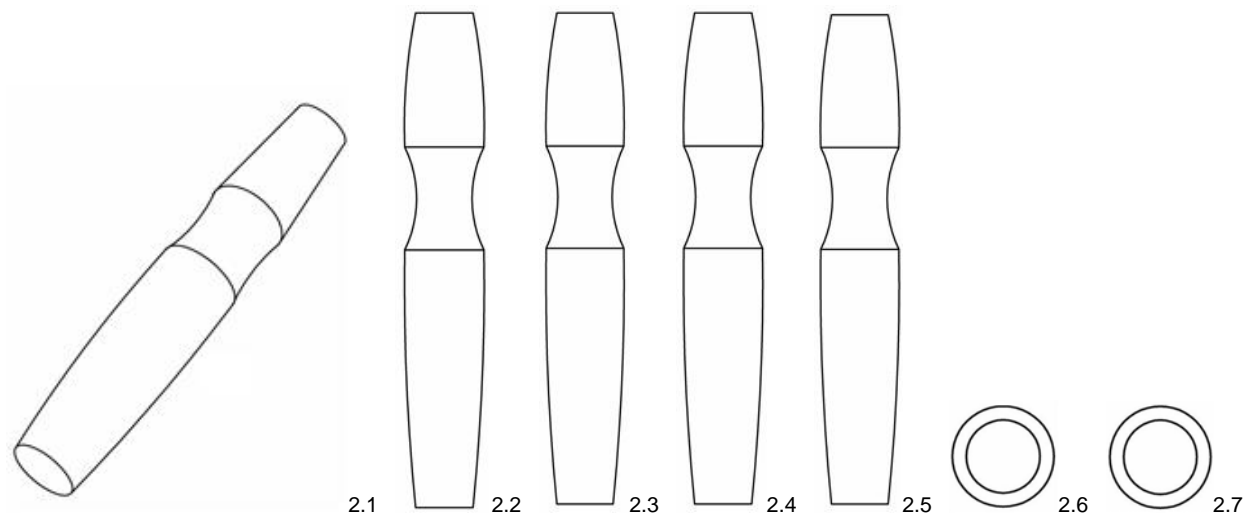

**Design 3**

- (54) **Produkt:** Hand-held aerosol generators
- (51) **Klasse:** 27-99
- (72) **Designer:** Jonathan Hogwood, 7 Chalkhill Barrow, SG86EQ MELBOURN, ROYSTON, HERTS, Storbritannia (GB)  
Aaron Abroff, 117 Hosmer St., MA01720 ACTON, USA (US)  
Stuart Cooper, 6 Merle Way, CB236FE LOWER CAMBOURNE, CAMBS, Storbritannia (GB)
- (30) **Prioritet:** 2011.12.23, EM, 001307656
- (55) **Designavbildninger:**

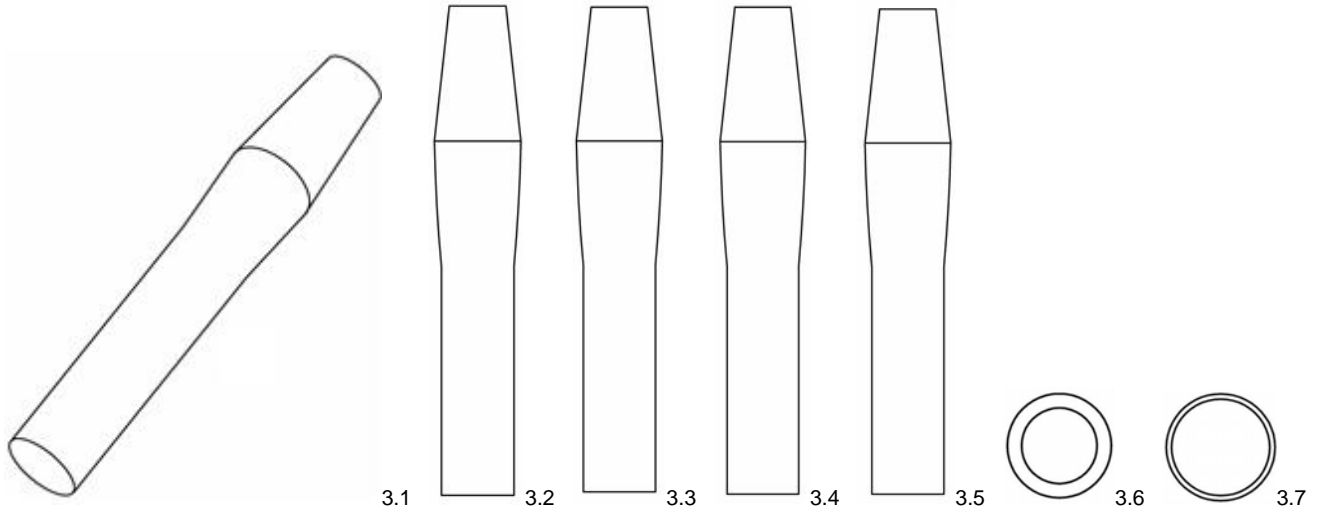

**Design 4**

- (54) **Produkt:** Hand-held aerosol generators
- (51) **Klasse:** 27-99
- (72) **Designer:** Aaron Abroff, 117 Hosmer St., MA01720 ACTON, USA (US)
- (30) **Prioritet:** 2011.12.23, EM, 001307656
- (55) **Designavbildninger:**

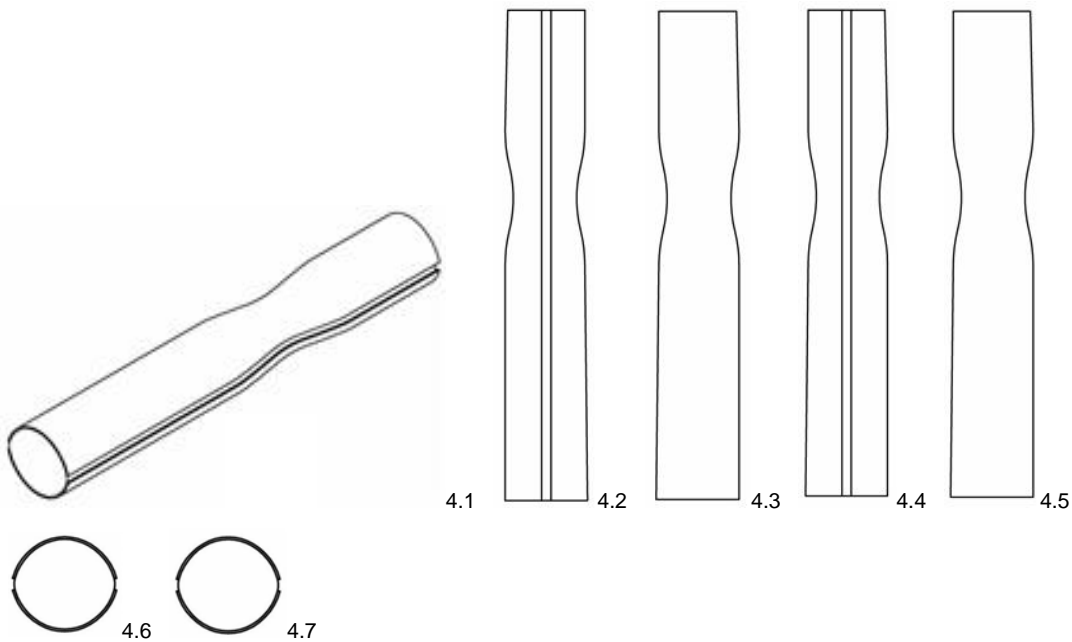

**Design 5**

- (54) **Produkt:** Hand-held aerosol generators
- (51) **Klasse:** 27-99
- (72) **Designer:** Aaron Abroff, 117 Hosmer St., MA01720 ACTON, USA (US)
- (30) **Prioritet:** 2011.12.23, EM, 001307656
- (55) **Designavbildninger:**

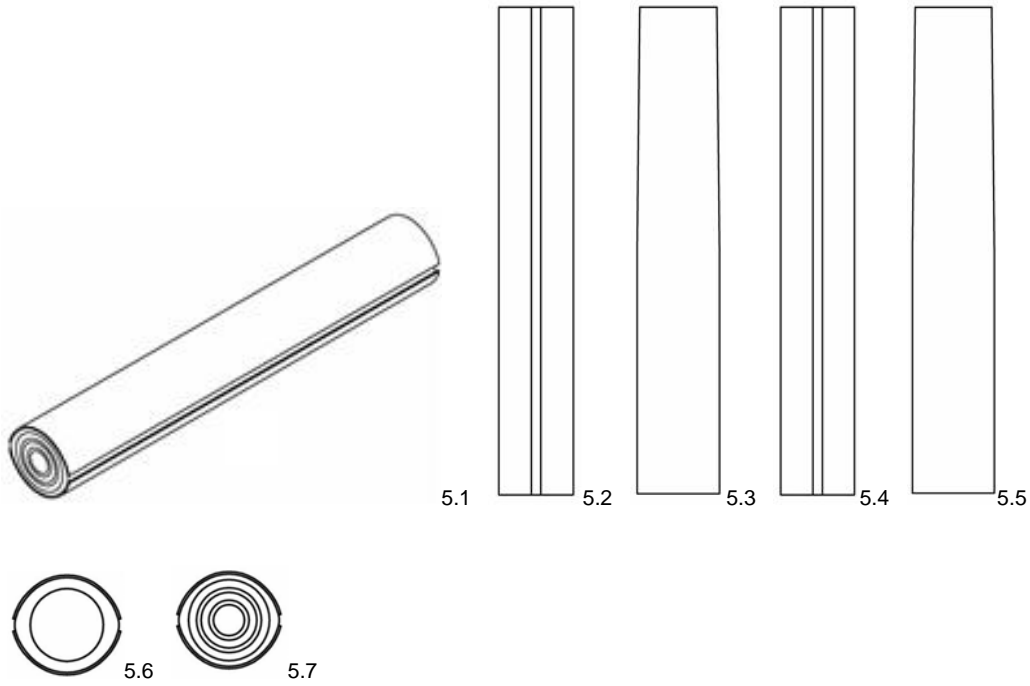

**Design 6**

- (54) **Produkt:** Hand-held aerosol generators
- (51) **Klasse:** 27-99
- (72) **Designer:** Aaron Abroff, 117 Hosmer St., MA01720 ACTON, USA (US)
- (30) **Prioritet:** 2011.12.23, EM, 001307656
- (55) **Designavbildninger:**

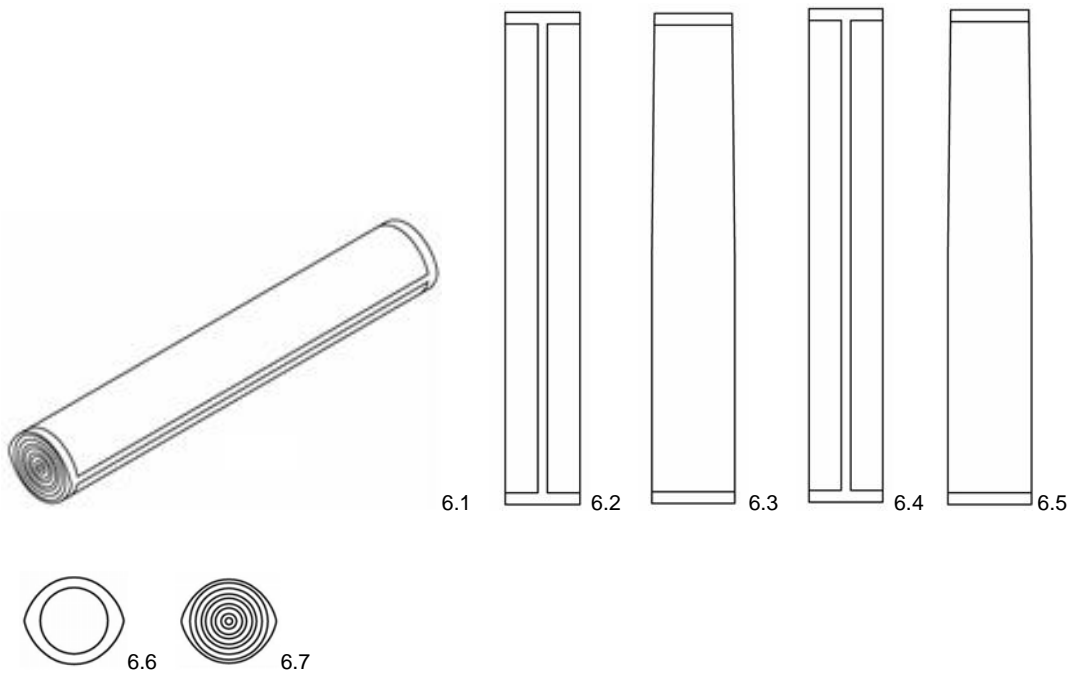

**Design 7**

(54) **Produkt:** Hand-held aerosol generators  
 (51) **Klasse:** 27-99  
 (72) **Designer:** Crispian Tompkin, 11960 Iowa Avenue, Apartment #4, CA90025 LOS ANGELES, USA (US)  
 Aaron Abroff, 117 Hosmer St., MA01720 ACTON, USA (US)  
 (30) **Prioritet:** 2011.12.23, EM, 001307656  
 (55) **Designavbildninger:**

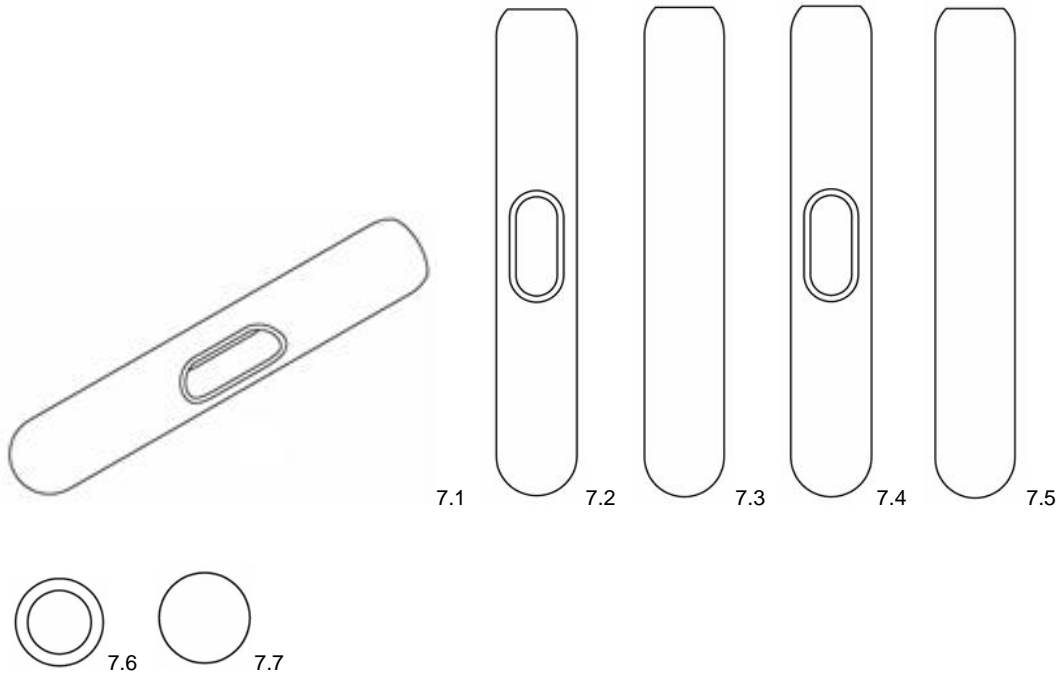

**Design 8**

(54) **Produkt:** Hand-held aerosol generators  
 (51) **Klasse:** 27-99  
 (72) **Designer:** Aaron Abroff, 117 Hosmer St., MA01720 ACTON, USA (US)  
 (30) **Prioritet:** 2011.12.23, EM, 001307656  
 (55) **Designavbildninger:**

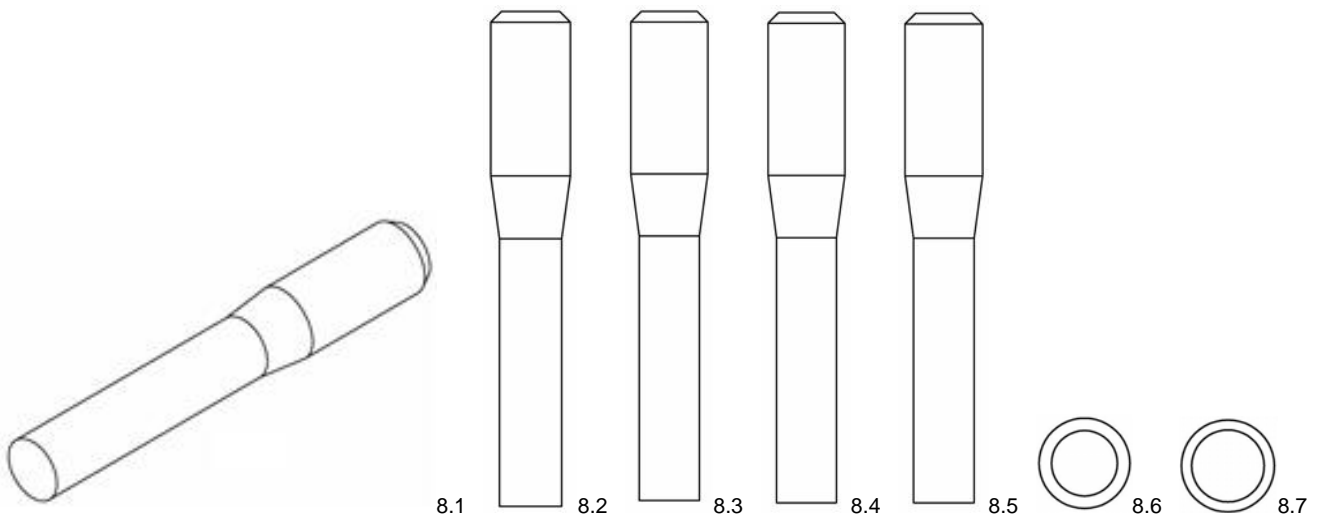



**Design 9**

(54) **Produkt:** Hand-held aerosol generators  
 (51) **Klasse:** 27-99  
 (72) **Designer:** Jonathan Hogwood, 7 Chalkhill Barrow, SG86EQ MELBOURN, ROYSTON, HERTS, Storbritannia (GB)  
 Crispian Tompkin, 11960 Iowa Avenue, Apartment #4, CA90025 LOS ANGELES, USA (US)  
 Aaron Abroff, 117 Hosmer St., MA01720 ACTON, USA (US)  
 Stuart Cooper, 6 Merle Way, CB236FE LOWER CAMBOURNE, CAMBS, Storbritannia (GB)  
 Philip Leung, 90 High Street Unit 1, MA02453 WALTHAM, USA (US)  
 (30) **Prioritet:** 2011.12.23, EM, 001307656  
 (55) **Designavbildninger:**

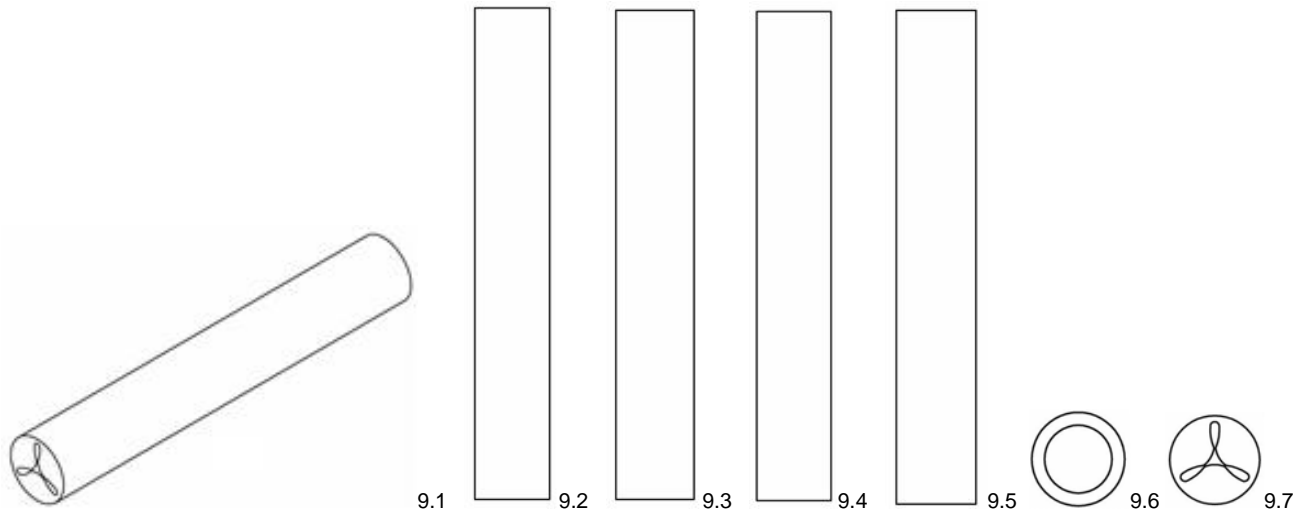

**Design 10**

(54) **Produkt:** Hand-held aerosol generators  
 (51) **Klasse:** 27-99  
 (72) **Designer:** Crispian Tompkin, 11960 Iowa Avenue, Apartment #4, CA90025 LOS ANGELES, USA (US)  
 (30) **Prioritet:** 2011.12.23, EM, 001307656  
 (55) **Designavbildninger:**

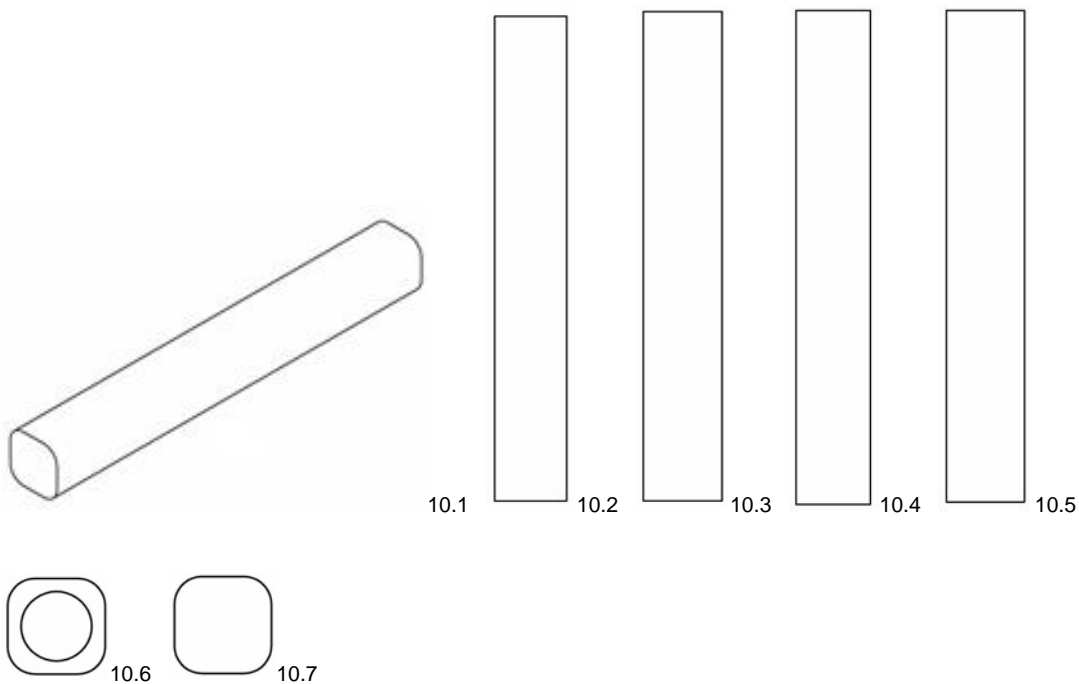

**Design 11**

- (54) **Produkt:** Hand-held aerosol generators
- (51) **Klasse:** 27-99
- (72) **Designer:** Crispian Tompkin, 11960 Iowa Avenue, Apartment #4, CA90025 LOS ANGELES, USA (US)  
Philip Leung, 90 High Street Unit 1, MA02453 WALTHAM, USA (US)
- (30) **Prioritet:** 2011.12.23, EM, 001307656
- (55) **Designavbildninger:**

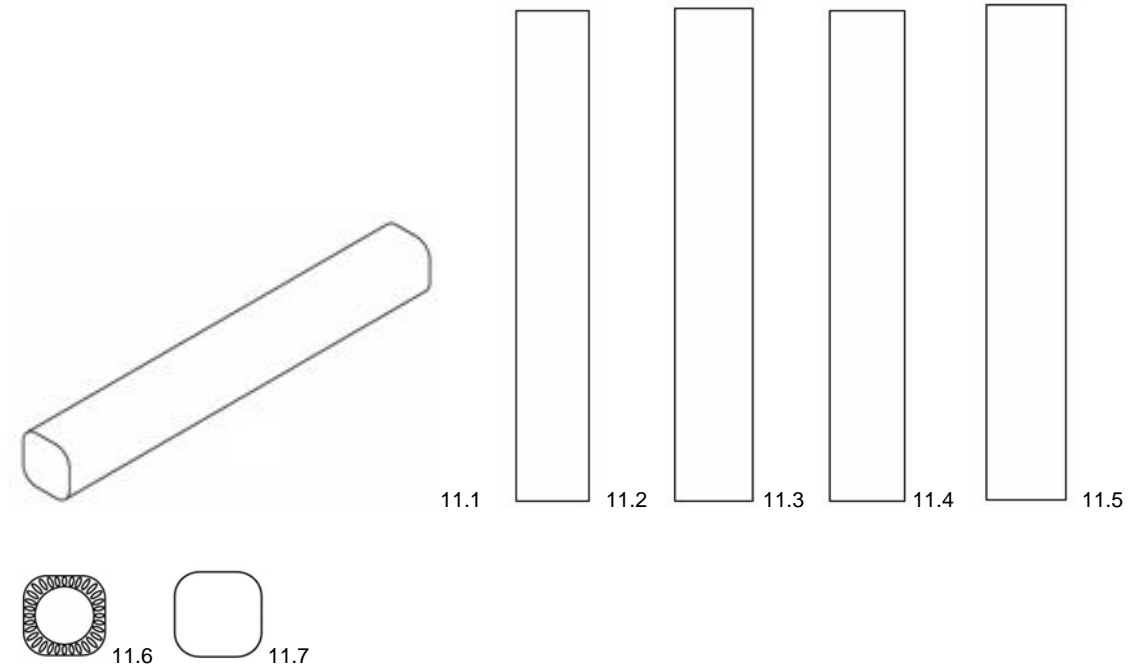

**Design 12**

- (54) **Produkt:** Hand-held aerosol generators
- (51) **Klasse:** 27-99
- (72) **Designer:** Crispian Tompkin, 11960 Iowa Avenue, Apartment #4, CA90025 LOS ANGELES, USA (US)  
Philip Leung, 90 High Street Unit 1, MA02453 WALTHAM, USA (US)
- (30) **Prioritet:** 2011.12.23, EM, 001307656
- (55) **Designavbildninger:**

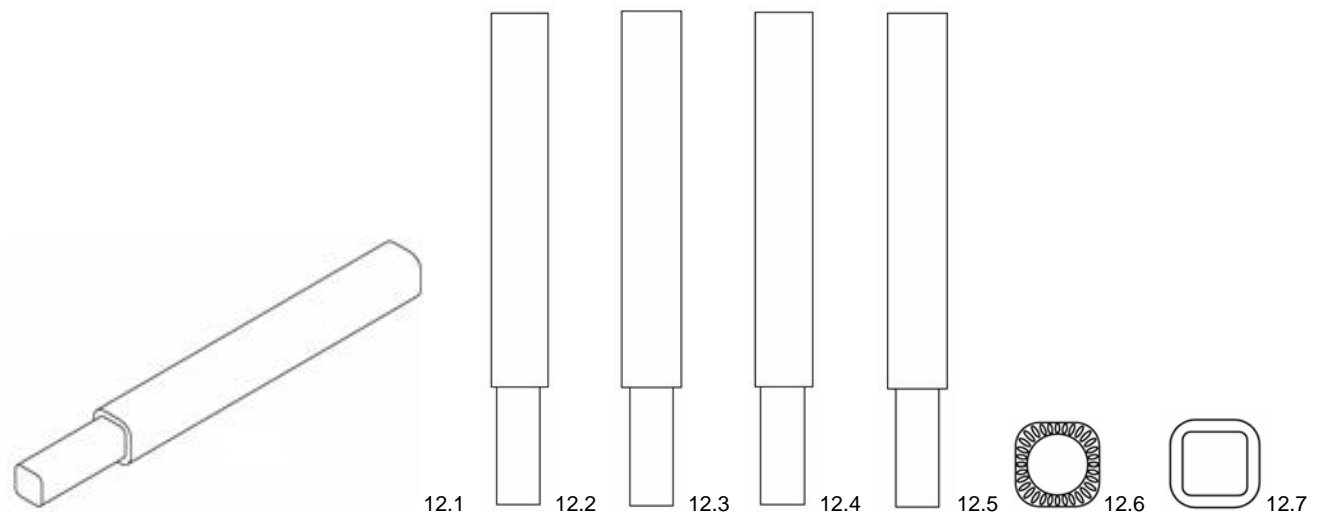

**Design 13**

(54) **Produkt:** Hand-held aerosol generators  
 (51) **Klasse:** 27-99  
 (72) **Designer:** Crispian Tompkin, 11960 Iowa Avenue, Apartment #4, CA90025 LOS ANGELES, USA (US)  
 Aaron Abroff, 117 Hosmer St., MA01720 ACTON, USA (US)  
 (30) **Prioritet:** 2011.12.23, EM, 001307656  
 (55) **Designavbildninger:**

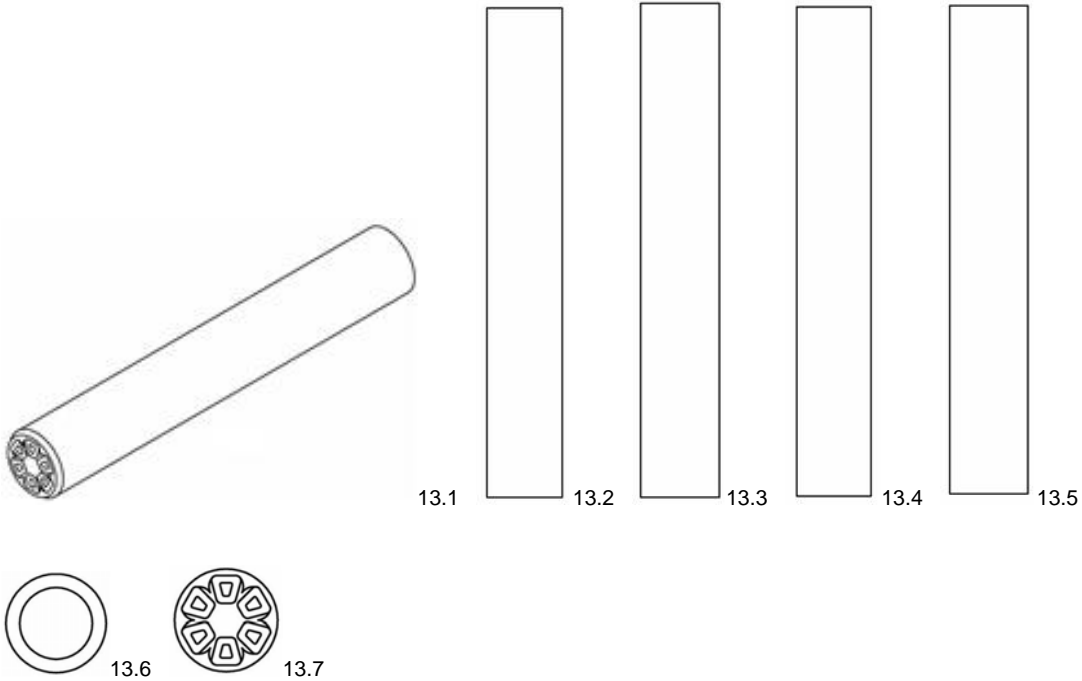

**Design 14**

(54) **Produkt:** Hand-held aerosol generators  
 (51) **Klasse:** 27-99  
 (72) **Designer:** Aaron Abroff, 117 Hosmer St., MA01720 ACTON, USA (US)  
 (30) **Prioritet:** 2011.12.23, EM, 001307656  
 (55) **Designavbildninger:**

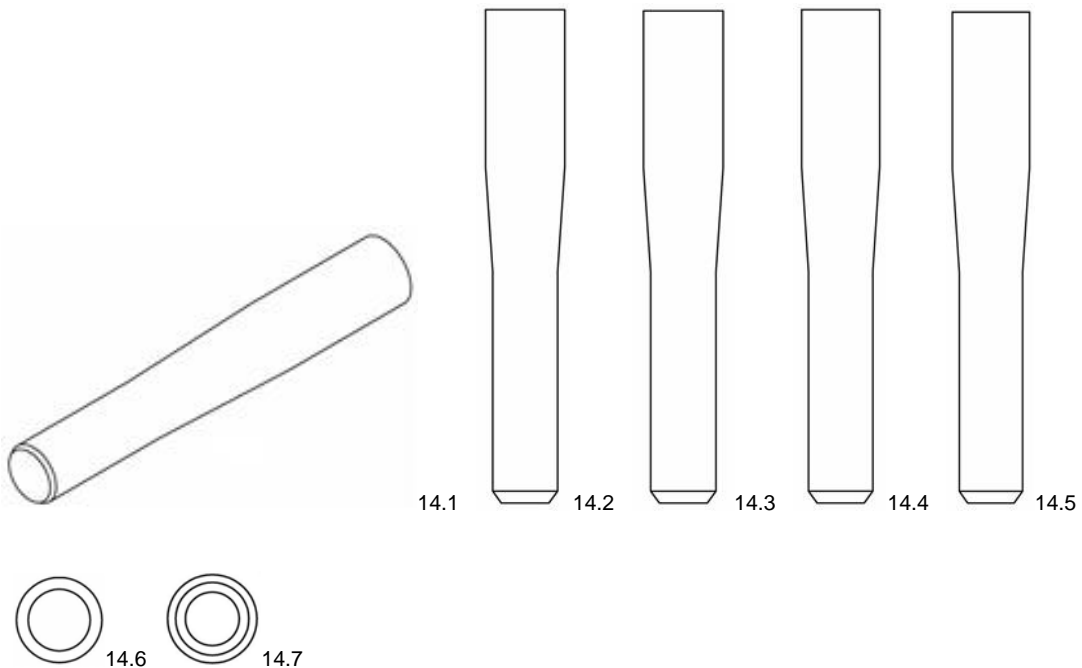

- (11) **Reg.nr.:** DM/079354  
(21) **Søkn.nr.:** 20121014  
(22) **Inngitt:** 2012.06.25  
(24) **Løpedag:** 2012.06.25  
(43) **Allm. tilgj.:** 2012.12.28  
(15) **Registrert:** 2012.06.25  
(45) **Kunngjort:** 2013.02.04  
(18) **Reg. gjelder til:** 2017.06.25  
(73) **Innehaver:** Malin Lilliesköld AB, Lugnviksvägen 93 A, SE-83152 ÖSTERSUND, Sverige  
(50) **Anmerkninger:** Registreringen gjelder samregistrering.

### Design 1

- (54) **Produkt:** Cleaning cloth  
(51) **Klasse:** 07-05  
(72) **Designer:** Malin Lilliesköld, Lugnviksvägen 93 A, 83152 ÖSTERSUND, Sverige (SE)  
(55) **Designavbildninger:**

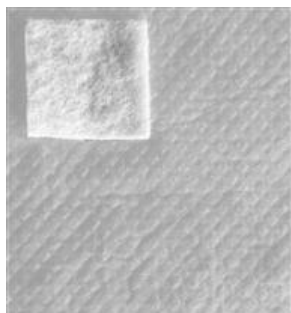

1.1

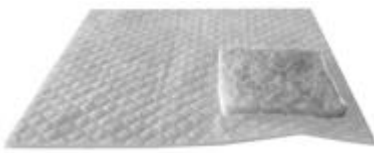

1.2



1.3

### Design 2

- (54) **Produkt:** Cleaning cloth  
(51) **Klasse:** 07-05  
(72) **Designer:** Malin Lilliesköld, Lugnviksvägen 93 A, 83152 ÖSTERSUND, Sverige (SE)  
(55) **Designavbildninger:**

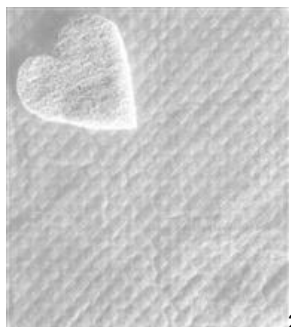

2.1

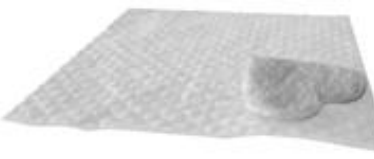

2.2



2.3

### Design 3

- (54) **Produkt:** Cleaning cloth  
(51) **Klasse:** 07-05  
(72) **Designer:** Malin Lilliesköld, Lugnviksvägen 93 A, 83152 ÖSTERSUND, Sverige (SE)  
(55) **Designavbildninger:**

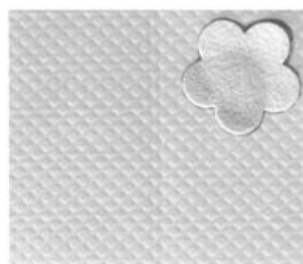

3.1

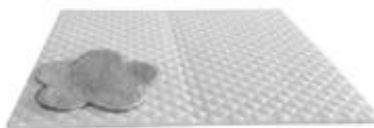

3.2



3.3

**Design 4**

(54) **Produkt:** Cleaning cloth  
(51) **Klasse:** 07-05  
(72) **Designer:** Malin Lilliesköld, Lugnviksvägen 93 A, 83152 ÖSTERSUND, Sverige (SE)  
(55) **Designavbildninger:**

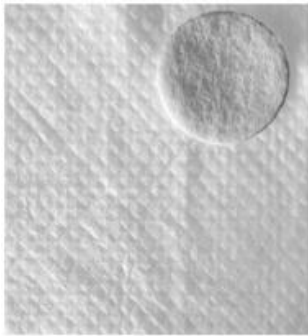

4.1

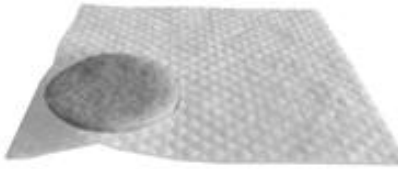

4.2



4.3

(11)	<b>Reg.nr.:</b>	<b>DM/079440</b>
(21)	<b>Søkn.nr.:</b>	20121090
(22)	<b>Inngitt:</b>	2012.11.01
(24)	<b>Løpedag:</b>	2012.11.01
(43)	<b>Allm. tilgj.:</b>	2012.11.16
(15)	<b>Registrert:</b>	2012.11.01
(45)	<b>Kunngjort:</b>	2013.02.04
(18)	<b>Reg. gjelder til:</b>	2017.11.01
(73)	<b>Innehaver:</b>	Swatch AG (Swatch SA) (Swatch Ltd), Jakob-Stämpfli-Strasse 94, CH-2502 BIEL/BIENNE, Sveits
(50)	<b>Anmerkninger:</b>	Registreringen gjelder samregistrering. Design nr. 2 og 3 er i farger.

### Design 1

(54)	<b>Produkt:</b>	Wristwatches
(51)	<b>Klasse:</b>	10-02
(72)	<b>Designer:</b>	Danilo Sala, Swatchlab, Via Archimede 6, 20129 MILANO, Italia (IT)
(55)	<b>Designavbildninger:</b>	



1.1

### Design 2

(54)	<b>Produkt:</b>	Wristwatches
(51)	<b>Klasse:</b>	10-02
(72)	<b>Designer:</b>	Ylenia Agate, Swatchlab, Via Archimede 6, 20129 MILANO, Italia (IT)
(55)	<b>Designavbildninger:</b>	



2.1



2.2

**Design 3**

(54)	<b>Produkt:</b>	Wristwatches
(51)	<b>Klasse:</b>	10-02
(72)	<b>Designer:</b>	Rossana Boffi, Swatchlab, Via Archimede 6, 20129 MILANO, Italia (IT)
(55)	<b>Designavbildninger:</b>	



3.1



3.2

(11)	<b>Reg.nr.:</b>	<b>DM/079490</b>
(21)	<b>Søkn.nr.:</b>	20121103
(22)	<b>Inngitt:</b>	2012.09.19
(24)	<b>Løpedag:</b>	2012.09.19
(43)	<b>Allm. tilgj.:</b>	2012.11.30
(15)	<b>Registrert:</b>	2012.09.19
(45)	<b>Kunngjort:</b>	2013.02.04
(18)	<b>Reg. gjelder til:</b>	2017.09.19
(73)	<b>Innehaver:</b>	HDN Holding APS, Vollundvej 12, DK-6040 EGTVED, Danmark
(50)	<b>Anmerkninger:</b>	Registreringen gjelder samregistrering.

### Design 1

(54)	<b>Produkt:</b>	Furniture doors
(51)	<b>Klasse:</b>	06-06
(72)	<b>Designer:</b>	Jørgen Nielsen, c/o Hanne Duus, Vollundvej 2, 6040 EGTVED, Danmark (DK)
(55)	<b>Designavbildninger:</b>	

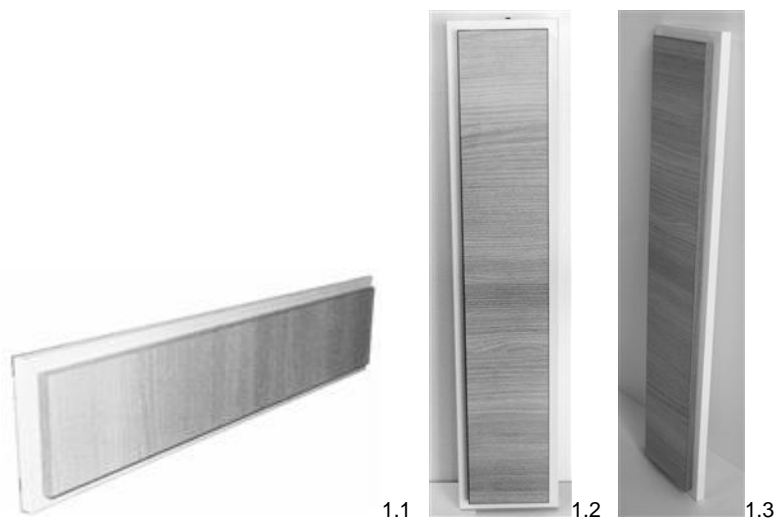

### Design 2

(54)	<b>Produkt:</b>	Furniture doors
(51)	<b>Klasse:</b>	06-06
(72)	<b>Designer:</b>	Jørgen Nielsen, c/o Hanne Duus, Vollundvej 2, 6040 EGTVED, Danmark (DK)
(55)	<b>Designavbildninger:</b>	

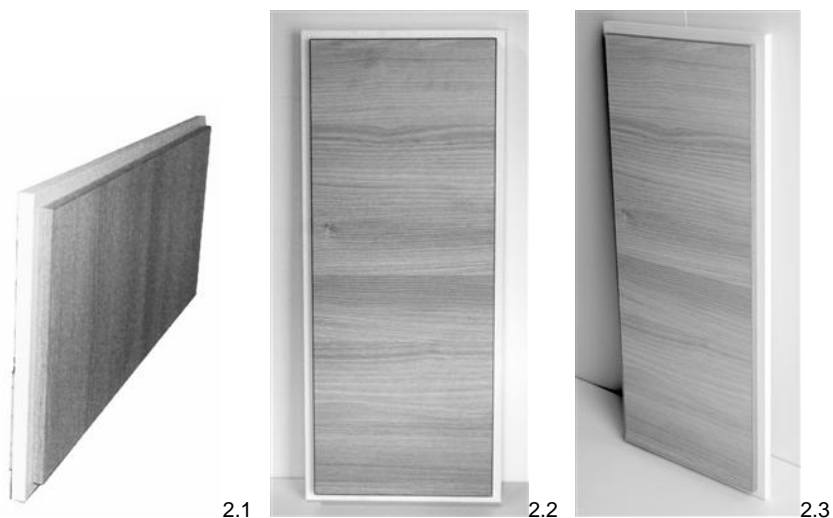



**Design 3**

(54) **Produkt:** Furniture doors  
(51) **Klasse:** 06-06  
(72) **Designer:** Jørgen Nielsen, c/o Hanne Duus, Vollundvej 2, 6040 EGTVED, Danmark (DK)  
(55) **Designavbildninger:**

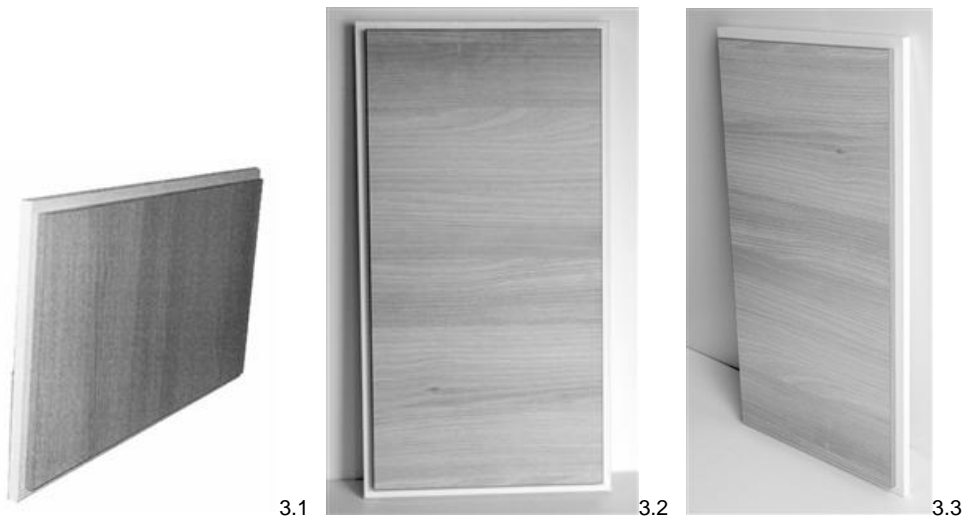
**Design 4**

(54) **Produkt:** Furniture doors  
(51) **Klasse:** 06-06  
(72) **Designer:** Jørgen Nielsen, c/o Hanne Duus, Vollundvej 2, 6040 EGTVED, Danmark (DK)  
(55) **Designavbildninger:**

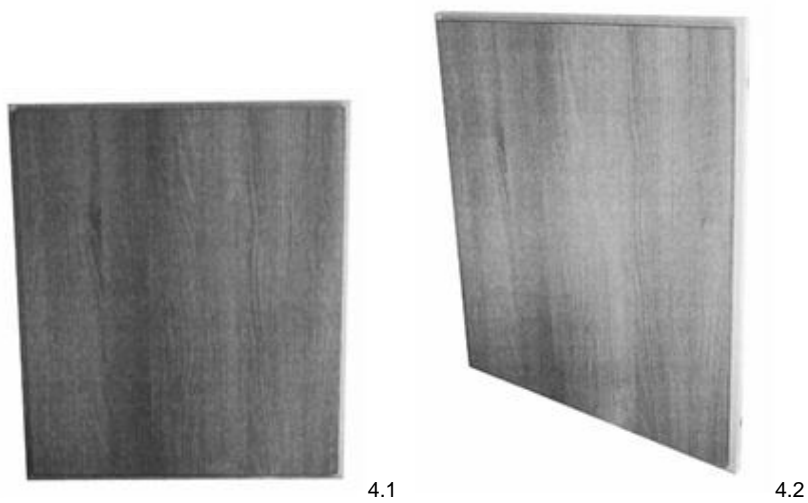

**Design 5**

- (54) **Produkt:** Furniture doors  
(51) **Klasse:** 06-06  
(72) **Designer:** Jørgen Nielsen, c/o Hanne Duus, Vollundvej 2, 6040 EGTVED, Danmark (DK)  
(55) **Designavbildninger:**

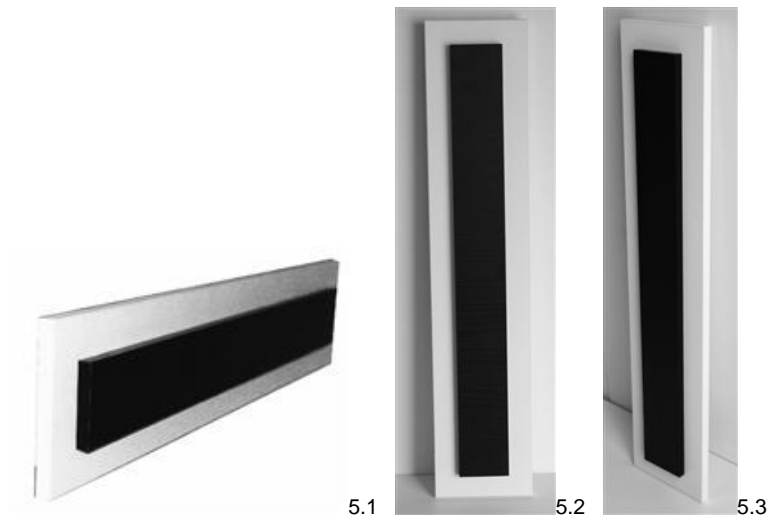
**Design 6**

- (54) **Produkt:** Furniture doors  
(51) **Klasse:** 06-06  
(72) **Designer:** Jørgen Nielsen, c/o Hanne Duus, Vollundvej 2, 6040 EGTVED, Danmark (DK)  
(55) **Designavbildninger:**

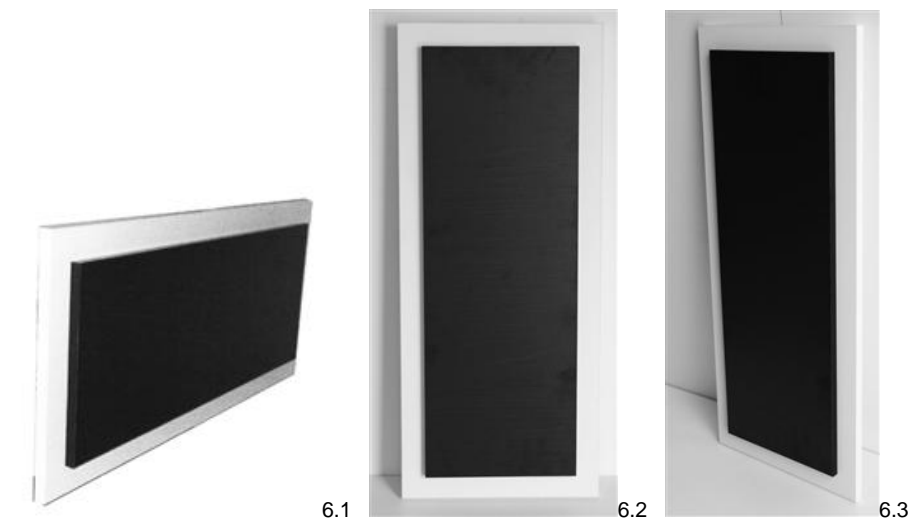

**Design 7**

- (54) **Produkt:** Furniture doors  
(51) **Klasse:** 06-06  
(72) **Designer:** Jørgen Nielsen, c/o Hanne Duus, Vollundvej 2, 6040 EGTVED, Danmark (DK)  
(55) **Designavbildninger:**

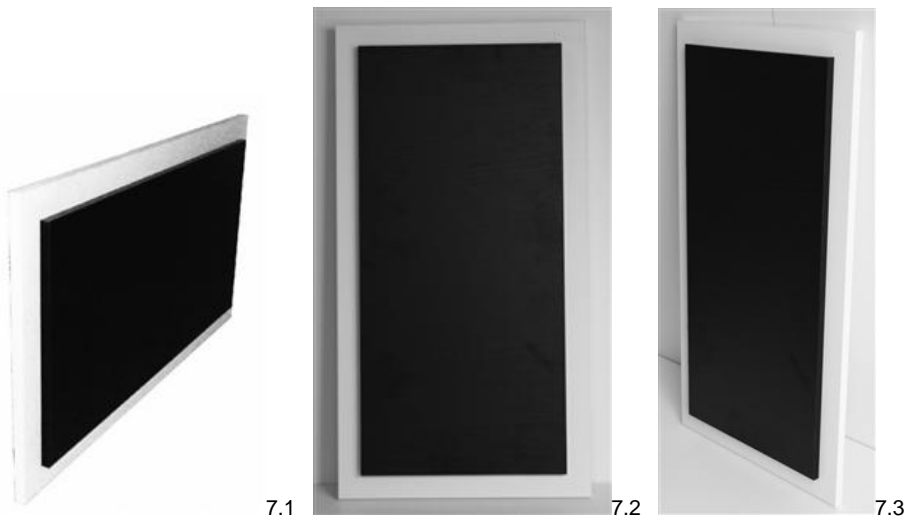
**Design 8**

- (54) **Produkt:** Furniture doors  
(51) **Klasse:** 06-06  
(72) **Designer:** Jørgen Nielsen, c/o Hanne Duus, Vollundvej 2, 6040 EGTVED, Danmark (DK)  
(55) **Designavbildninger:**

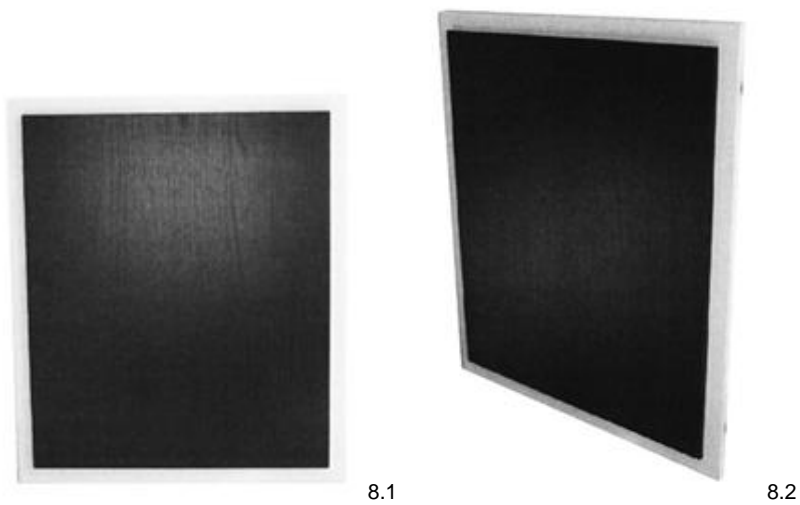

**Design 9**

- (54) **Produkt:** Furniture doors  
(51) **Klasse:** 06-06  
(72) **Designer:** Jørgen Nielsen, c/o Hanne Duus, Vollundvej 2, 6040 EGTVED, Danmark (DK)  
(55) **Designavbildninger:**



9.1



9.2

(11)	<b>Reg.nr.:</b>	<b>DM/079526</b>
(21)	<b>Søkn.nr.:</b>	20121112
(22)	<b>Inngitt:</b>	2012.11.09
(24)	<b>Løpedag:</b>	2012.11.09
(43)	<b>Allm. tilgj.:</b>	2012.11.30
(15)	<b>Registrert:</b>	2012.11.09
(45)	<b>Kunngjort:</b>	2013.02.04
(18)	<b>Reg. gjelder til:</b>	2017.11.09
(73)	<b>Innehaver:</b>	SIMON SAU, c/ Diputación, 390-392, ES-08013 BARCELONA, Spania
(50)	<b>Anmerkninger:</b>	Registreringen gjelder samregistrering.

### Design 1

(54)	<b>Produkt:</b>	Accessories for electric devices
(51)	<b>Klasse:</b>	13-03
(72)	<b>Designer:</b>	Maria Cristina Moret Codina, Ferran Agulló 20 pral. 1º, 08021 BARCELONA, Spania (ES)
(30)	<b>Prioritet:</b>	2012.05.16, ES, 514847
(55)	<b>Designavbildninger:</b>	

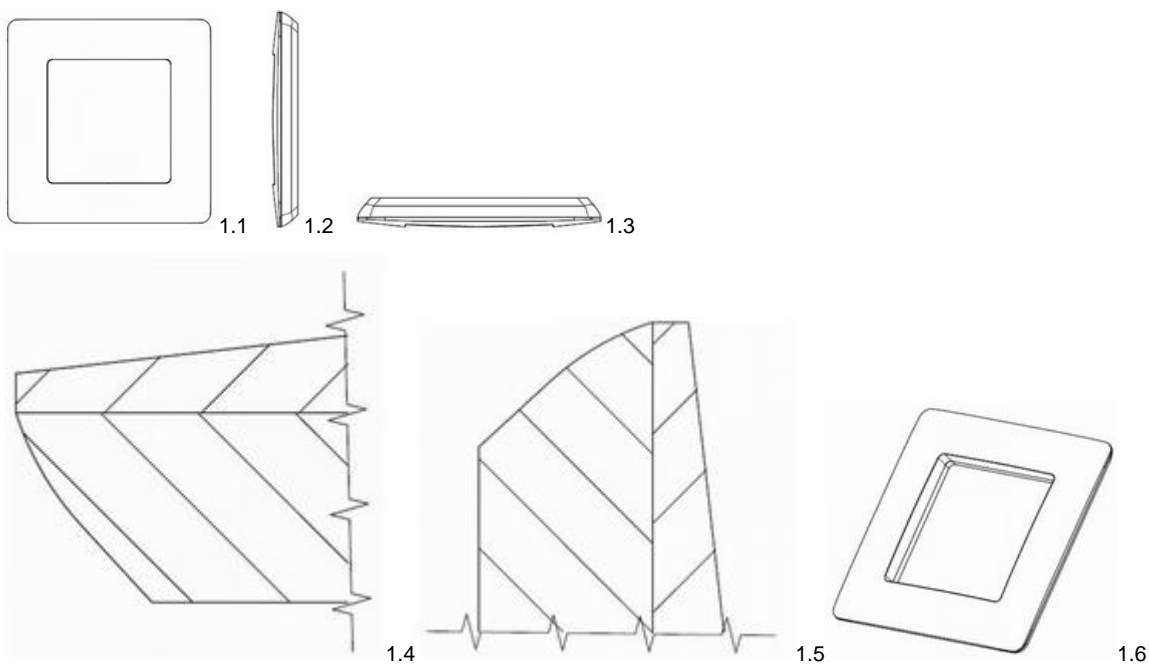

### Design 2

(54)	<b>Produkt:</b>	Accessories for electric devices
(51)	<b>Klasse:</b>	13-03
(72)	<b>Designer:</b>	Maria Cristina Moret Codina, Ferran Agulló 20 pral. 1º, 08021 BARCELONA, Spania (ES)
(30)	<b>Prioritet:</b>	2012.05.16, ES, 514847
(55)	<b>Designavbildninger:</b>	

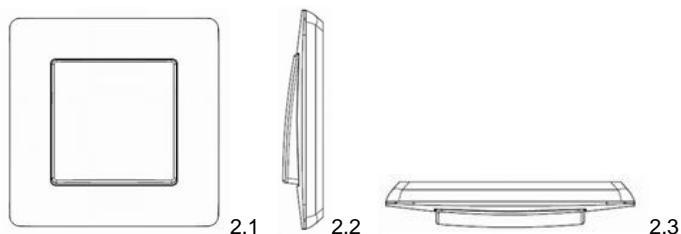

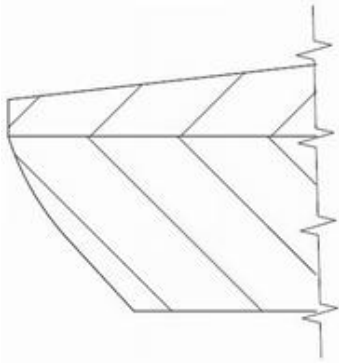

2.4

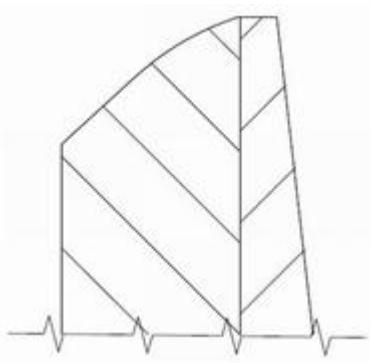

2.5

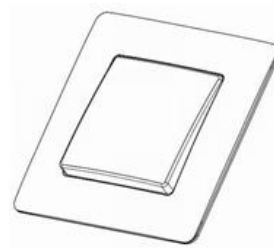

2.6

**Design 3**

- (54) **Produkt:** Accessories for electric devices
- (51) **Klasse:** 13-03
- (72) **Designer:** Maria Cristina Moret Codina, Ferran Agulló 20 pral. 1º, 08021 BARCELONA, Spania (ES)
- (30) **Prioritet:** 2012.05.16, ES, 514847
- (55) **Designavbildninger:**

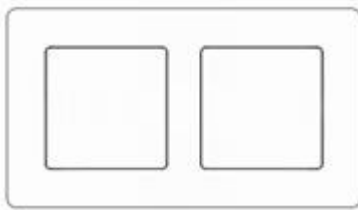

3.1



3.2



3.3

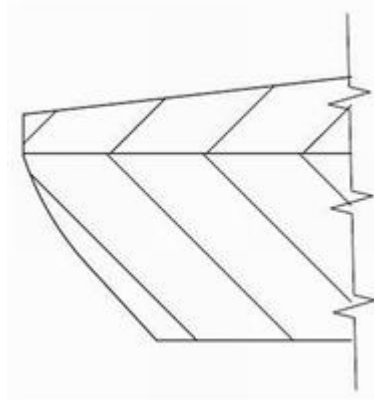

3.4



3.5

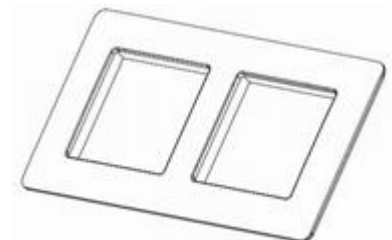

3.6

**Design 4**

- (54) **Produkt:** Accessories for electric devices
- (51) **Klasse:** 13-03
- (72) **Designer:** Maria Cristina Moret Codina, Ferran Agulló 20 pral. 1º, 08021 BARCELONA, Spania (ES)
- (30) **Prioritet:** 2012.05.16, ES, 514847
- (55) **Designavbildninger:**

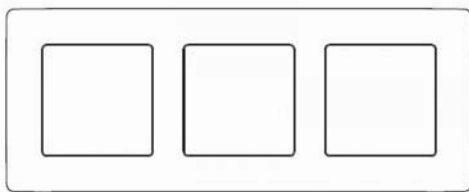

4.1



4.2



4.3

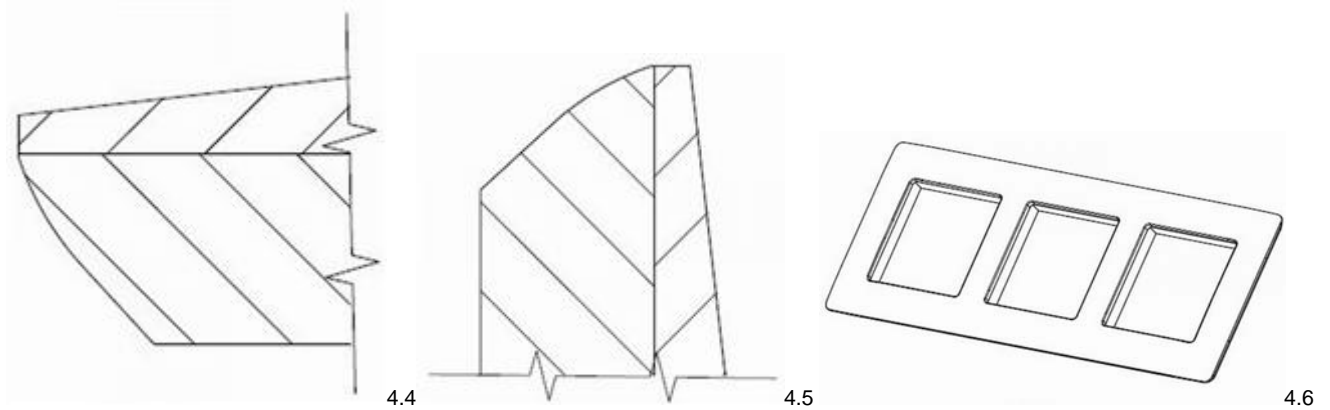

**Design 5**

(54) **Produkt:** Accessories for electric devices  
 (51) **Klasse:** 13-03  
 (72) **Designer:** Maria Cristina Moret Codina, Ferran Agulló 20 pral. 1º, 08021 BARCELONA, Spania (ES)  
 (30) **Prioritet:** 2012.05.16, ES, 514847  
 (55) **Designavbildninger:**

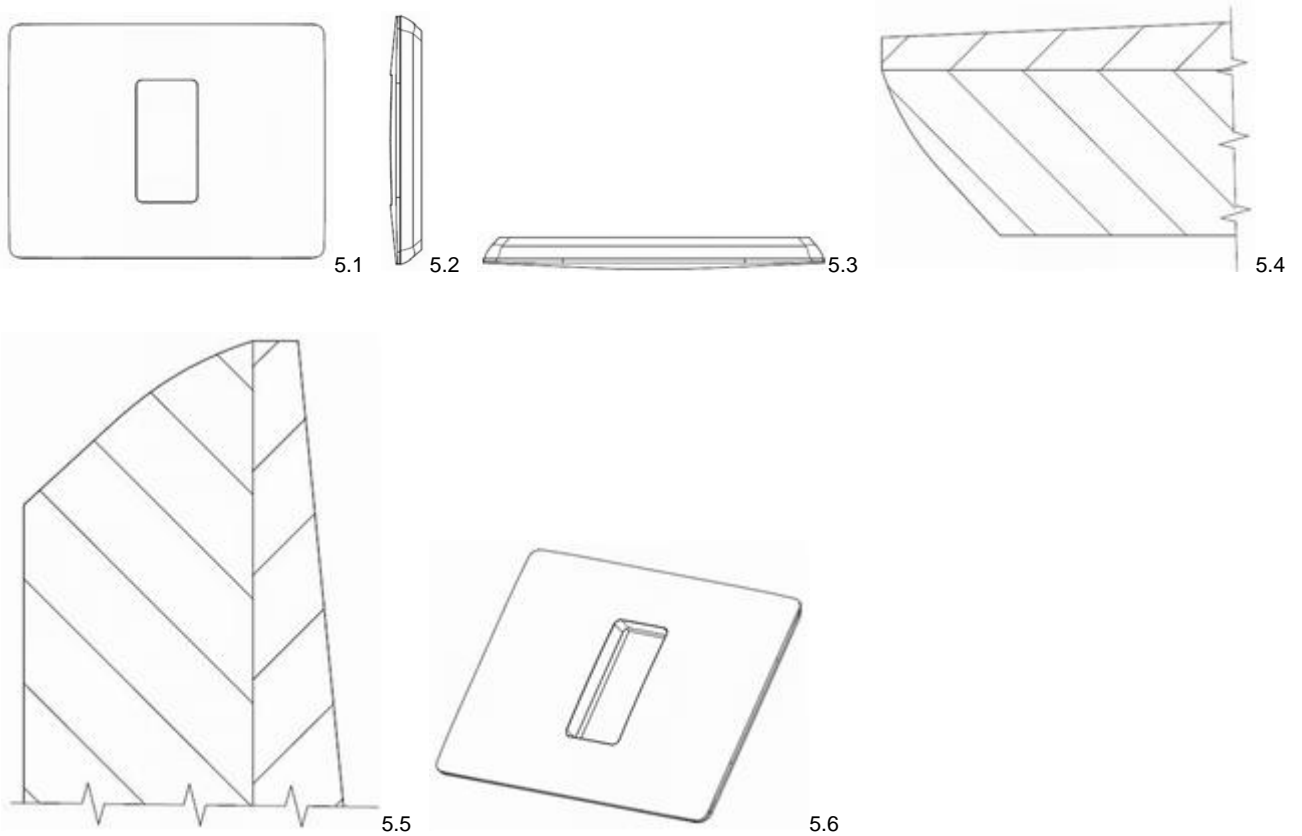

**Design 6**

- (54) **Produkt:** Accessories for electric devices  
(51) **Klasse:** 13-03  
(72) **Designer:** Maria Cristina Moret Codina, Ferran Agulló 20 pral. 1°, 08021 BARCELONA, Spania (ES)  
(30) **Prioritet:** 2012.05.16, ES, 514847  
(55) **Designavbildninger:**

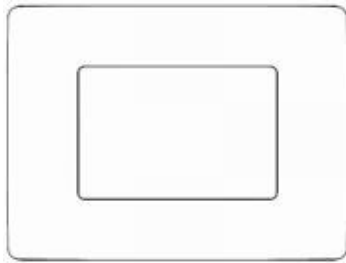

6.1



6.2



6.3

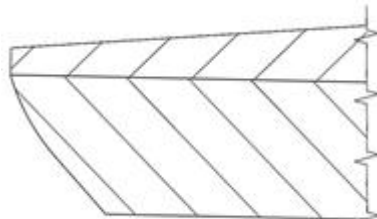

6.4

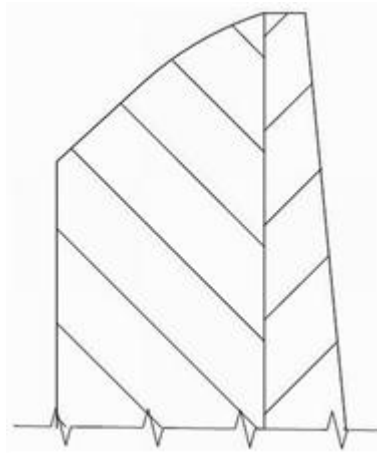

6.5

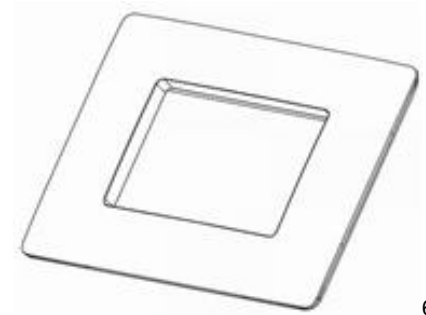

6.6

**Design 7**

- (54) **Produkt:** Accessories for electric devices  
(51) **Klasse:** 13-03  
(72) **Designer:** Maria Cristina Moret Codina, Ferran Agulló 20 pral. 1°, 08021 BARCELONA, Spania (ES)  
(30) **Prioritet:** 2012.05.16, ES, 514847  
(55) **Designavbildninger:**

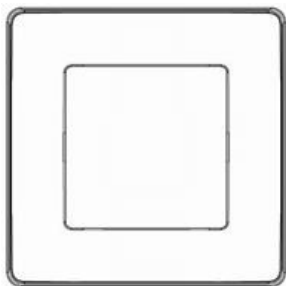

7.1



7.2



7.3

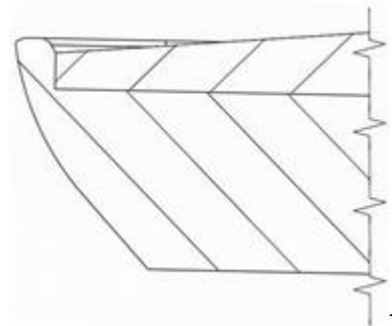

7.4



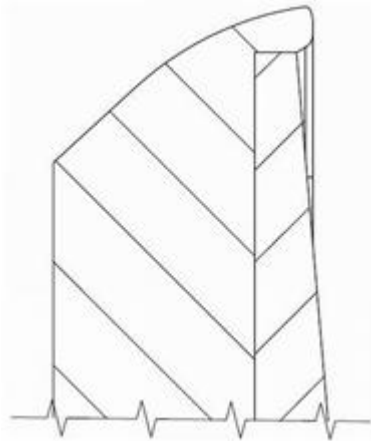

7.5

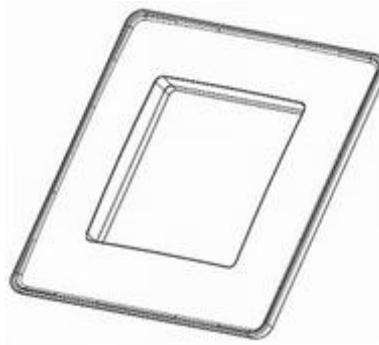

7.6

**Design 8**

(54) **Produkt:** Accessories for electric devices  
 (51) **Klasse:** 13-03  
 (72) **Designer:** Maria Cristina Moret Codina, Ferran Agulló 20 pral. 1º, 08021 BARCELONA, Spania (ES)  
 (30) **Prioritet:** 2012.05.16, ES, 514847  
 (55) **Designavbildninger:**

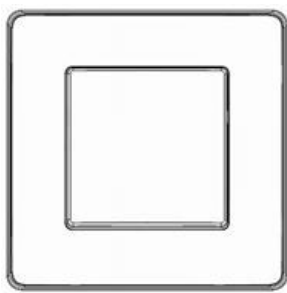

8.1

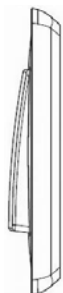

8.2



8.3

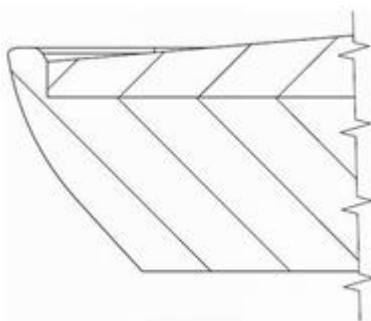

8.4

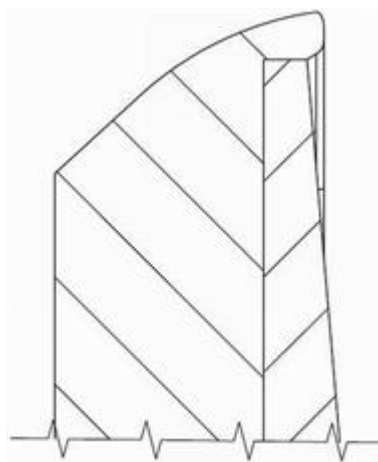

8.5

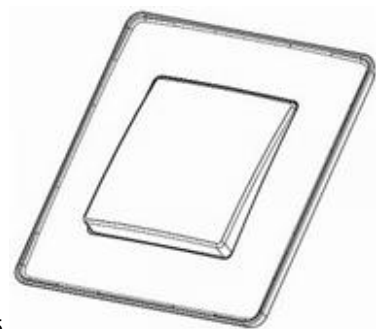

8.6

**Design 9**

- (54) **Produkt:** Accessories for electric devices  
 (51) **Klasse:** 13-03  
 (72) **Designer:** Maria Cristina Moret Codina, Ferran Agulló 20 pral. 1º, 08021 BARCELONA, Spania (ES)  
 (30) **Prioritet:** 2012.05.16, ES, 514847  
 (55) **Designavbildninger:**

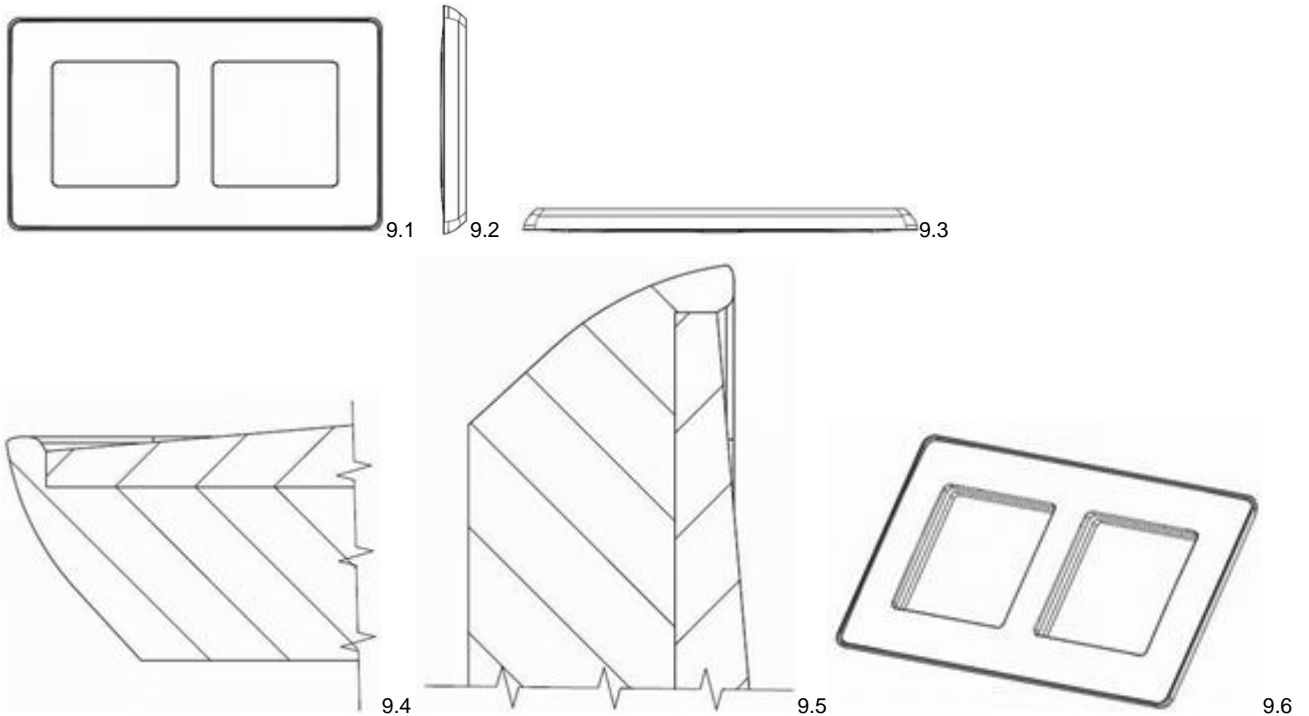
**Design 10**

- (54) **Produkt:** Accessories for electric devices  
 (51) **Klasse:** 13-03  
 (72) **Designer:** Maria Cristina Moret Codina, Ferran Agulló 20 pral. 1º, 08021 BARCELONA, Spania (ES)  
 (30) **Prioritet:** 2012.05.16, ES, 514847  
 (55) **Designavbildninger:**

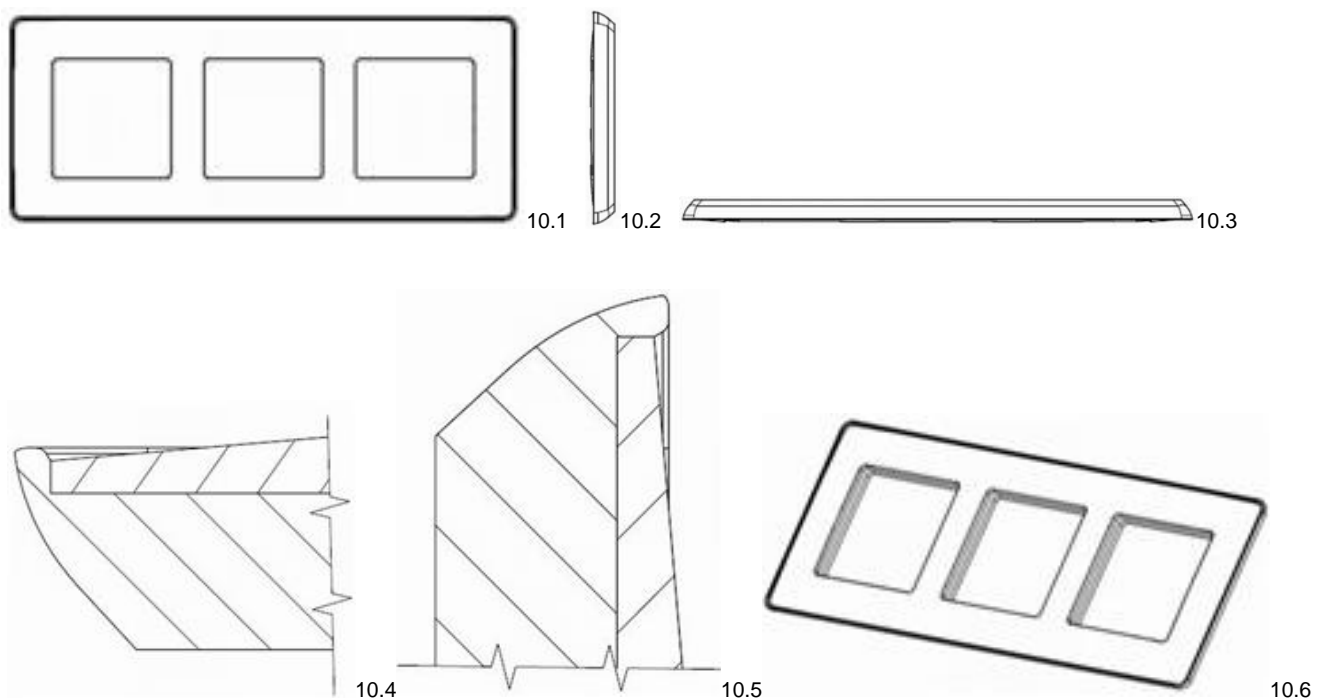

**Design 11**

- (54) **Produkt:** Accessories for electric devices  
(51) **Klasse:** 13-03  
(72) **Designer:** Maria Cristina Moret Codina, Ferran Agulló 20 pral. 1º, 08021 BARCELONA, Spania (ES)  
(30) **Prioritet:** 2012.05.16, ES, 514847  
(55) **Designavbildninger:**

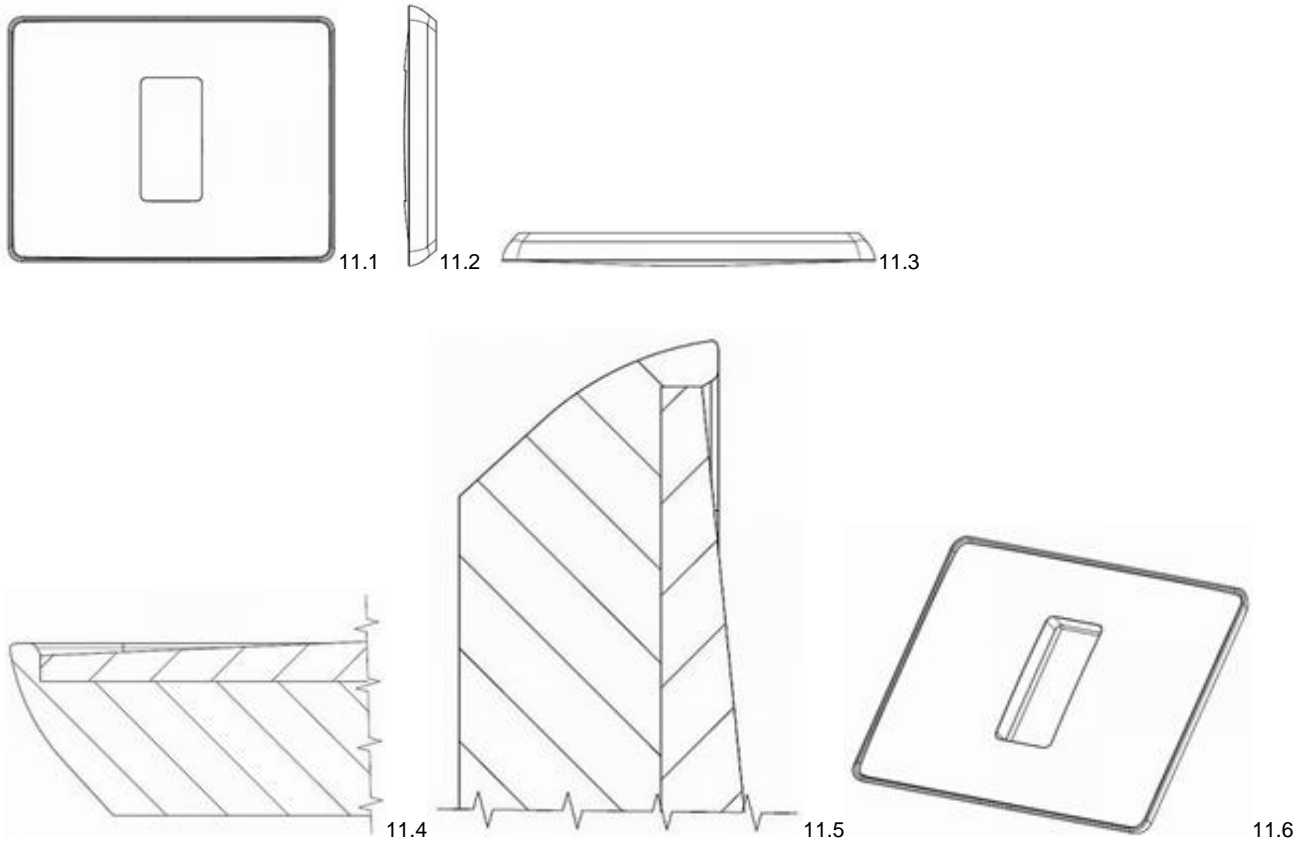
**Design 12**

- (54) **Produkt:** Accessories for electric devices  
(51) **Klasse:** 13-03  
(72) **Designer:** Maria Cristina Moret Codina, Ferran Agulló 20 pral. 1º, 08021 BARCELONA, Spania (ES)  
(30) **Prioritet:** 2012.05.16, ES, 514847  
(55) **Designavbildninger:**

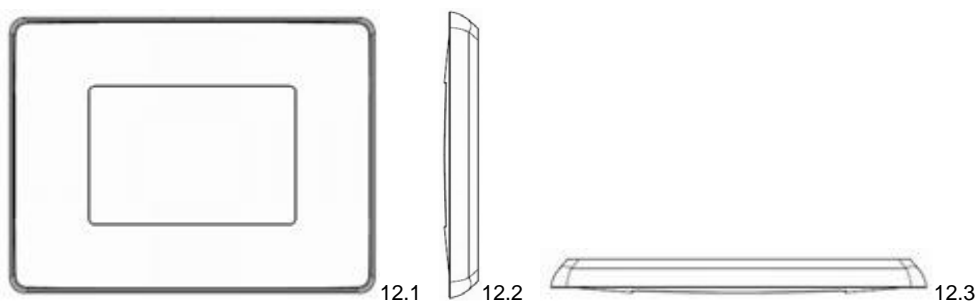

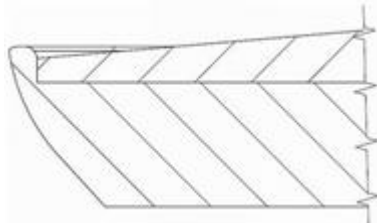

12.4

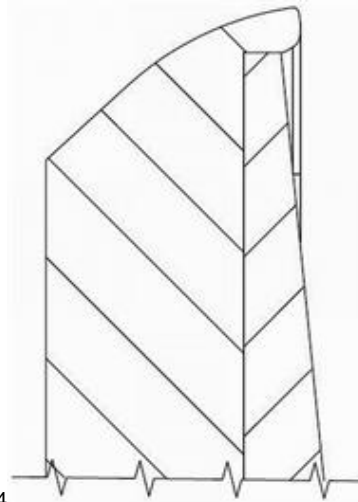

12.5

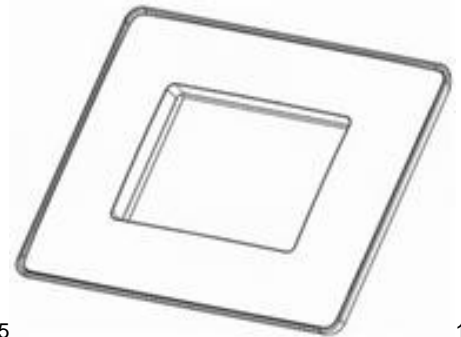

12.6

(11)	<b>Reg.nr.:</b>	<b>DM/079527</b>
(21)	<b>Søkn.nr.:</b>	20121113
(22)	<b>Inngitt:</b>	2012.05.03
(24)	<b>Løpedag:</b>	2012.05.03
(43)	<b>Allm. tilgj.:</b>	2012.11.30
(15)	<b>Registrert:</b>	2012.05.03
(45)	<b>Kunngjort:</b>	2013.02.04
(18)	<b>Reg. gjelder til:</b>	2017.05.03
(73)	<b>Innehaver:</b>	Villiger Public Systems GmbH, Bahnhofstrasse 13, CH-5647 OBERRÜTI, Sveits

## Design 1

(54)	<b>Produkt:</b>	Crane truck for waste containers
(51)	<b>Klasse:</b>	12-05 12-08
(72)	<b>Designer:</b>	Paul Villiger, Bahnhofstrasse 13, 5647 OBERRÜTI, Tyskland (DE)
(55)	<b>Designavbildninger:</b>	

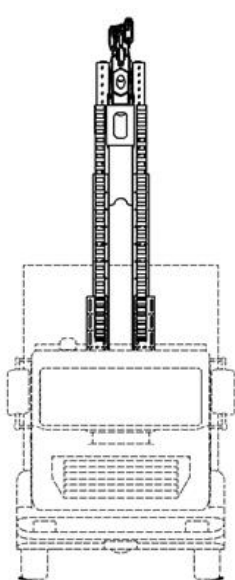

1.1

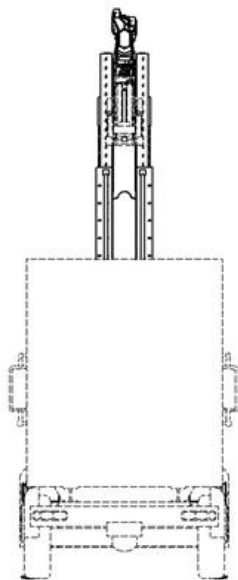

1.2

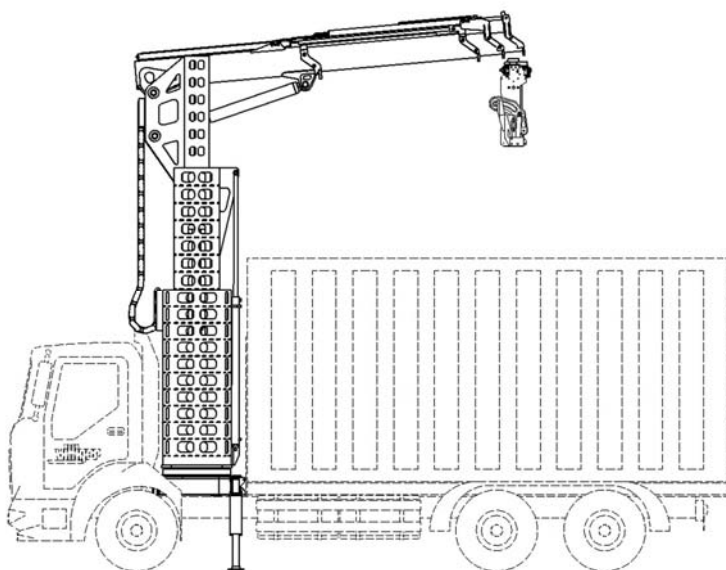

1.3

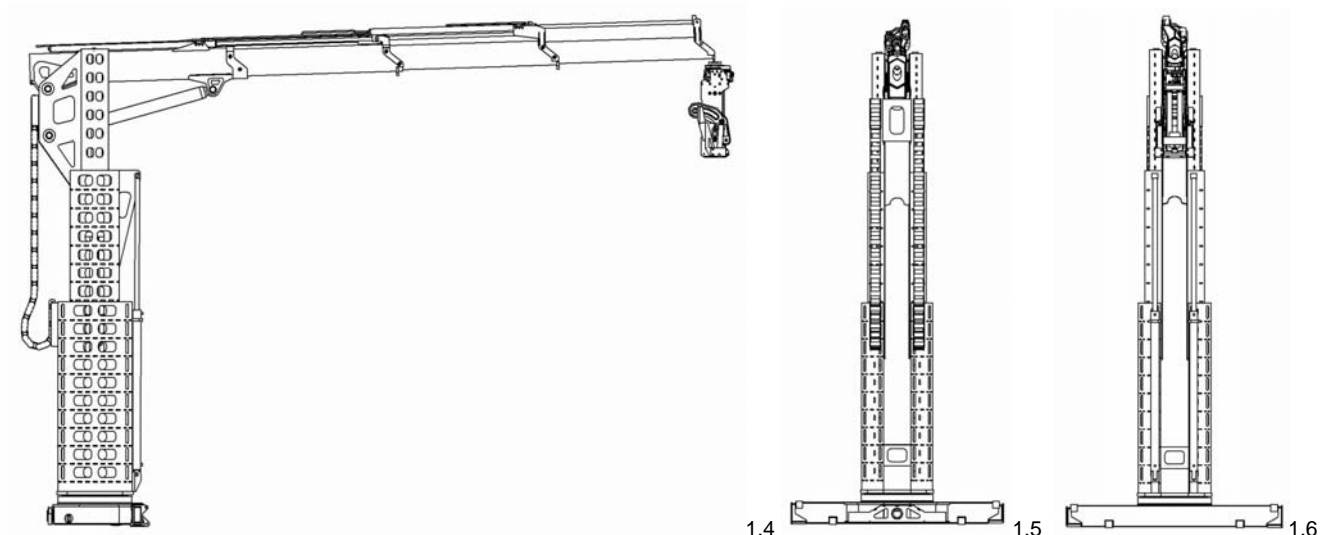

- (11) **Reg.nr.:** DM/079529  
 (21) **Søkn.nr.:** 20121114  
 (22) **Inngitt:** 2012.08.28  
 (24) **Løpedag:** 2012.08.28  
 (43) **Allm. tilgj.:** 2012.11.30  
 (15) **Registrert:** 2012.08.28  
 (45) **Kunngjort:** 2013.02.04  
 (18) **Reg. gjelder til:** 2017.08.28  
 (73) **Innehaver:** Eva Solo A/S, Måløv Teknikerby 18, DK-2760 MÅLØV, Danmark

### Design 1

- (54) **Produkt:** Bird table  
 (51) **Klasse:** 30-03  
 (72) **Designer:** Henrik Holbæk, Gæslingvej 29, 3080 TIKØB, Danmark (DK)  
 Claus Jensen, Gæslingvej 29, 3080 TIKØB, Danmark (DK)  
 (55) **Designavbildninger:**

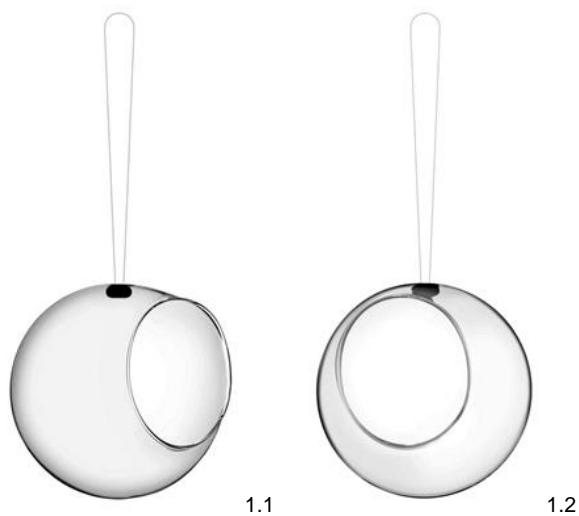

(11)	<b>Reg.nr.:</b>	<b>DM/079531</b>
(21)	<b>Søkn.nr.:</b>	20121116
(22)	<b>Inngitt:</b>	2012.08.30
(24)	<b>Løpedag:</b>	2012.08.30
(43)	<b>Allm. tilgj.:</b>	2012.11.30
(15)	<b>Registrert:</b>	2012.08.30
(45)	<b>Kunngjort:</b>	2013.02.04
(18)	<b>Reg. gjelder til:</b>	2017.08.30
(73)	<b>Innehaver:</b>	Eva Solo A/S, Måløv Teknikerby 18, DK-2760 MÅLØV, Danmark

**Design 1**

(54)	<b>Produkt:</b>	Bird table
(51)	<b>Klasse:</b>	30-03
(72)	<b>Designer:</b>	Henrik Holbæk, Gæslingvej 29, 3080 TIKØB, Danmark (DK) Claus Jensen, Gæslingvej 29, 3080 TIKØB, Danmark (DK)
(55)	<b>Designavbildninger:</b>	

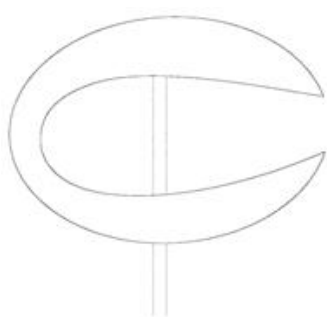

1.1



1.2



1.3

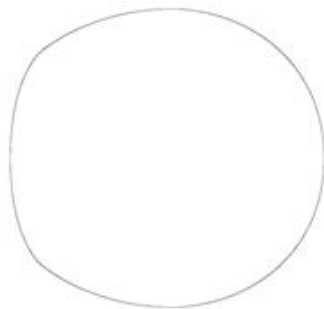

1.4



1.5

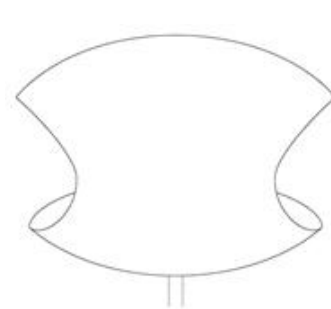

1.6



1.7

- (11) **Reg.nr.:** DM/079532  
(21) **Søkn.nr.:** 20121117  
(22) **Inngitt:** 2012.08.31  
(24) **Løpedag:** 2012.08.31  
(43) **Allm. tilgj.:** 2012.11.30  
(15) **Registrert:** 2012.08.31  
(45) **Kunngjort:** 2013.02.04  
(18) **Reg. gjelder til:** 2017.08.31  
(73) **Innehaver:** Eva Solo A/S, Måløv Teknikerby 18, DK-2760 MÅLØV, Danmark  
(50) **Anmerkninger:** Design nr. 4 er i farger.  
Registreringen gjelder samregistrering.

**Design 1**

- (54) **Produkt:** Teapot  
(51) **Klasse:** 07-01  
(72) **Designer:** Henrik Holbæk, Gæslingvej 29, 3080 TIKØB, Danmark (DK)  
Claus Jensen, Gæslingvej 29, 3080 TIKØB, Danmark (DK)  
(55) **Designavbildninger:**



1.1

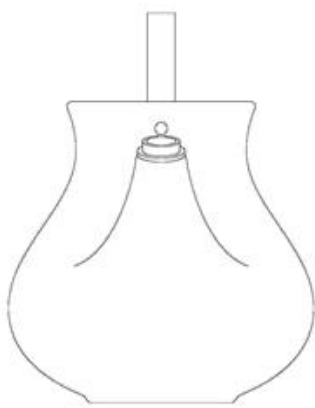

1.2

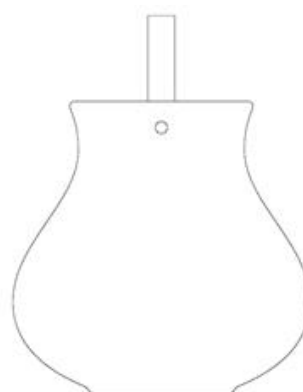

1.3

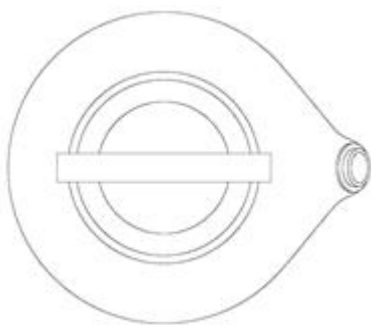

1.4

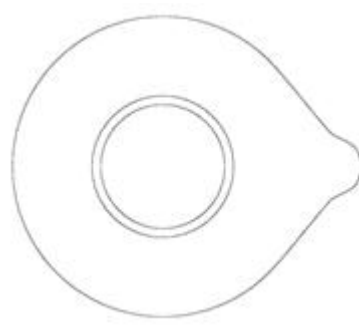

1.5



1.6

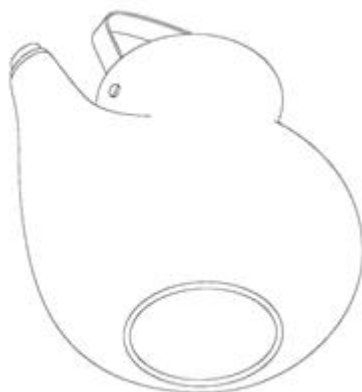

1.7



**Design 2**

- (54) **Produkt:** Teapots with tea cosies  
(51) **Klasse:** 07-01  
07-06  
(72) **Designer:** Henrik Holbæk, Gæslingvej 29, 3080 TIKØB, Danmark (DK)  
Claus Jensen, Gæslingvej 29, 3080 TIKØB, Danmark (DK)  
(55) **Designavbildninger:**



2.1



2.2



2.3



2.4



2.5



2.6



2.7

**Design 3**

- (54) **Produkt:** Teapots with tea cosies  
(51) **Klasse:** 07-01  
07-06  
(72) **Designer:** Henrik Holbæk, Gæslingvej 29, 3080 TIKØB, Danmark (DK)  
Claus Jensen, Gæslingvej 29, 3080 TIKØB, Danmark (DK)  
(55) **Designavbildninger:**



3.1



3.2



3.3



3.4



3.5



3.6



3.7

**Design 4**

- (54) **Produkt:** Teapots with tea cosies  
(51) **Klasse:** 07-01  
07-06  
(72) **Designer:** Henrik Holbæk, Gæslingvej 29, 3080 TIKØB, Danmark (DK)  
Claus Jensen, Gæslingvej 29, 3080 TIKØB, Danmark (DK)  
(50) **Anmerkning:** Designen er i farger.  
(55) **Designavbildninger:**



4.1



4.2



4.3



4.4



4.5



4.6



4.7

(11) **Reg.nr.:** DM/079554  
(21) **Søkn.nr.:** 20121121  
(22) **Inngitt:** 2012.08.02  
(24) **Løpedag:** 2012.08.02  
(43) **Allm. tilgj.:** 2012.12.07  
(15) **Registrert:** 2012.08.02  
(45) **Kunngjort:** 2013.02.04  
(18) **Reg. gjelder til:** 2017.08.02  
(73) **Innehaver:** Byzance Design, Route de Chêne 11, CH-1208 GENÈVE, Sveits

**Design 1**

(54) **Produkt:** Wall-mounted lamp  
(51) **Klasse:** 26-05  
(72) **Designer:** Adrien Slaby, 206 rue des Tulpiers, 01170 GEX, Frankrike (FR)  
(55) **Designavbildninger:**



1.1



1.2

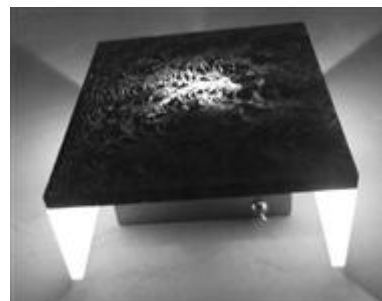

1.3



1.4

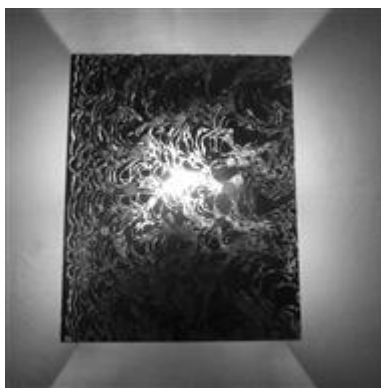

1.5



1.6

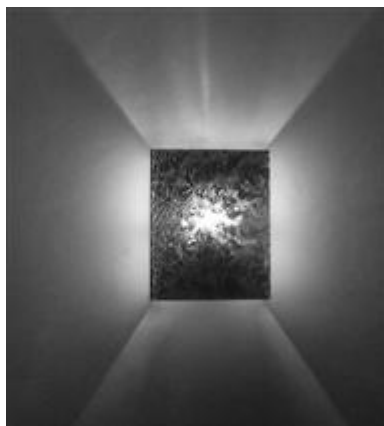

1.7

(11)	<b>Reg.nr.:</b>	<b>DM/079557</b>
(21)	<b>Søkn.nr.:</b>	20121123
(22)	<b>Inngitt:</b>	2012.09.20
(24)	<b>Løpedag:</b>	2012.09.20
(43)	<b>Allm. tilgj.:</b>	2012.12.07
(15)	<b>Registrert:</b>	2012.09.20
(45)	<b>Kunngjort:</b>	2013.02.04
(18)	<b>Reg. gjelder til:</b>	2017.09.20
(73)	<b>Innehaver:</b>	Invacare International SarL, Route de Cité-Ouest 2, CH-1196 GLAND, Sveits
(50)	<b>Anmerkninger:</b>	Design nr. 1 og 2 er i farger. Registreringen gjelder samregistrering.

### Design 1

(54)	<b>Produkt:</b>	Toilet chairs
(51)	<b>Klasse:</b>	23-02
(72)	<b>Designer:</b>	Mélanie Brochard, 8 rue Galpin Thiou, 37000 TOURS, Frankrike (FR)
(50)	<b>Anmerkning:</b>	Designen er i farger.
(55)	<b>Designavbildninger:</b>	



1.1



1.2



1.3



1.4

**Design 2**

(54)	<b>Produkt:</b>	Toilet chairs
(51)	<b>Klasse:</b>	23-02
(72)	<b>Designer:</b>	Mélanie Brochard, 8 rue Galpin Thiou, 37000 TOURS, Frankrike (FR)
(50)	<b>Anmerkning:</b>	Designen er i farger.
(55)	<b>Designavbildninger:</b>	



2.1



2.2



2.3



2.4



2.5



2.6



2.7

**Design 3**

(54) **Produkt:** Toilet chairs  
 (51) **Klasse:** 23-02  
 (72) **Designer:** Mélanie Brochard, 8 rue Galpin Thiou, 37000 TOURS, Frankrike (FR)  
 (55) **Designavbildninger:**



3.1



3.2

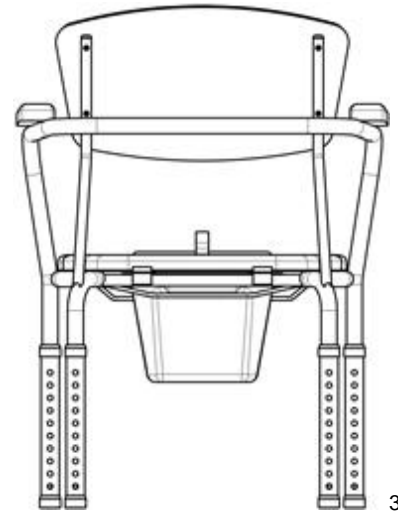

3.3

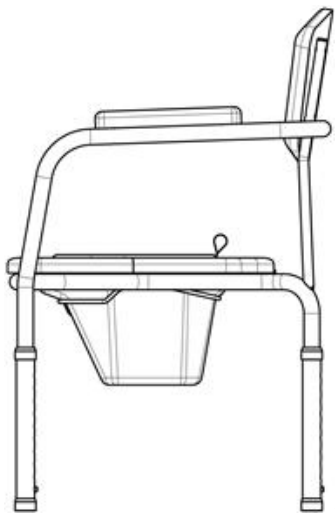

3.4

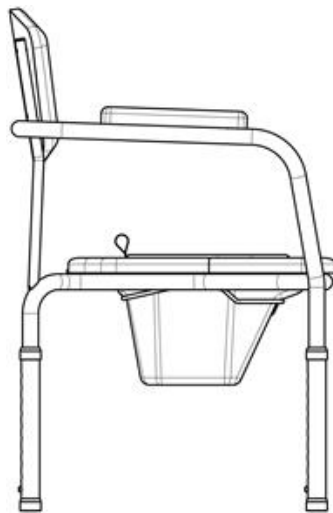

3.5

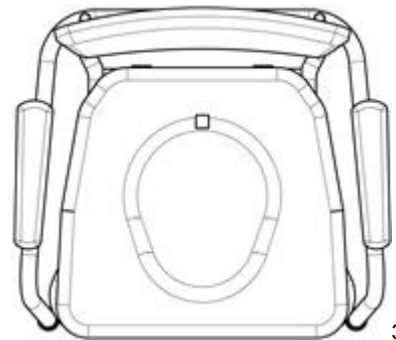

3.6

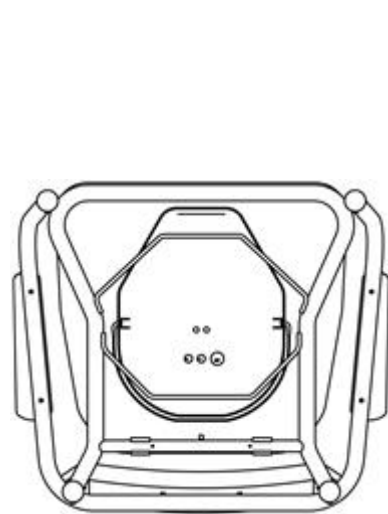

3.7



3.8



3.9



3.10



3.11



## Overdragelser

(11) **Reg.nr.:** 069785  
 (21) **Søknadsnr.** 19910081  
 (73) **Innehaver:** Kraft Foods Group Brands LLC, Three Lakes Drive, US-IL60093 NORTHFIELD, USA  
 (74) **Fullmektig:** Bryn Aarflot AS, Postboks 449 Sentrum, 0104 OSLO, Norge

---

(11) **Reg.nr.:** 072592  
 (21) **Søknadsnr.** 19950188  
 (73) **Innehaver:** Schneider Electric Danmark A/S, Industriparken 32, DK-2750 BALLERUP, Danmark  
 (74) **Fullmektig:** Schneider Electric Danmark A/S, v/Chéri Rehøj, Industriparken 32, DK-2750 BALLERUP, Danmark

---

(11) **Reg.nr.:** 074478  
 (21) **Søknadsnr.** 19970765  
 (73) **Innehaver:** Deutsche SiSi-Werke GmbH & Co Betriebs KG, Rudolf-Wild-Strasse 107-115, DE-69214 EPPELHEIM, Tyskland  
 (74) **Fullmektig:** Onsagers AS, Postboks 1813 Vika, 0123 OSLO, Norge

---

(11) **Reg.nr.:** 074605  
 (21) **Søknadsnr.** 19980031  
 (73) **Innehaver:** Deutsche SiSi-Werke GmbH & Co Betriebs KG, Rudolf-Wild-Strasse 107-115, DE-69214 EPPELHEIM, Tyskland  
 (74) **Fullmektig:** Onsagers AS, Postboks 1813 Vika, 0123 OSLO, Norge

---

(11) **Reg.nr.:** 074771  
 (21) **Søknadsnr.** 19980030  
 (73) **Innehaver:** Deutsche SiSi-Werke GmbH & Co Betriebs KG, Rudolf-Wild-Strasse 107-115, DE-69214 EPPELHEIM, Tyskland  
 (74) **Fullmektig:** Onsagers AS, Postboks 1813 Vika, 0123 OSLO, Norge

---

(11) **Reg.nr.:** 074772  
 (21) **Søknadsnr.** 19980033  
 (73) **Innehaver:** Deutsche SiSi-Werke GmbH & Co Betriebs KG, Rudolf-Wild-Strasse 107-115, DE-69214 EPPELHEIM, Tyskland  
 (74) **Fullmektig:** Onsagers AS, Postboks 1813 Vika, 0123 OSLO, Norge

---

(11) **Reg.nr.:** 079248  
 (21) **Søknadsnr.** 20050139  
 (73) **Innehaver:** Schneider Electric Danmark A/S, Industriparken 32, DK-2750 BALLERUP, Danmark  
 (74) **Fullmektig:** Schneider Electric Danmark A/S, v/Chéri Rehøj, Industriparken 32, DK-2750 BALLERUP, Danmark

---

(11) **Reg.nr.:** 081191  
 (21) **Søknadsnr.** 20080122  
 (73) **Innehaver:** Ide og Utvikling AS, Svaleveien 16, 8200 FAUSKE, Norge

---

(11) **Reg.nr.:** 081192  
 (21) **Søknadsnr.** 20080123  
 (73) **Innehaver:** Ide og Utvikling AS, Svaleveien 16, 8200 FAUSKE, Norge

---

(11) **Reg.nr.:** 083444  
 (21) **Søknadsnr.** 20120142  
 (73) **Innehaver:** Mars Norge AS, Hovfaret 13, 0275 OSLO, Norge  
 (74) **Fullmektig:** Onsagers AS, Postboks 1813 Vika, 0123 OSLO, Norge

---

## Endringer i fullmaktsforhold

(11) **Reg.nr.:** 071246  
(21) **Søknadsnr.** 19930053  
(73) **Innehaver:** Anders Smith, Frederiksholms  
Kanal 1, DK-1220  
KØBENHAVN, Danmark  
(74) **Fullmektig:** Chéri Rehøj, c/o Schneider  
Electric Danmark A/S,  
Industriparken 32, DE-2750  
BALLERUP, Tyskland

---

(11) **Reg.nr.:** 072592  
(21) **Søknadsnr.** 19950188  
(73) **Innehaver:** Schneider Electric Danmark A/S,  
Industriparken 32, DK-2750  
BALLERUP, Danmark  
(74) **Fullmektig:** Schneider Electric Danmark A/S,  
v/Chéri Rehøj, Industriparken  
32, DK-2750 BALLERUP,  
Danmark

---

(11) **Reg.nr.:** 079248  
(21) **Søknadsnr.** 20050139  
(73) **Innehaver:** Schneider Electric Danmark A/S,  
Industriparken 32, DK-2750  
BALLERUP, Danmark  
(74) **Fullmektig:** Schneider Electric Danmark A/S,  
v/Chéri Rehøj, Industriparken  
32, DK-2750 BALLERUP,  
Danmark

---

(11) **Reg.nr.:** 083448  
(21) **Søknadsnr.** 20110913  
(73) **Innehaver:** MERCANTE AS, Grini  
Næringspark 8, 1361  
ØSTERÅS, Norge  
(74) **Fullmektig:** Hynell AS, Parkveien 53 B, 0256  
OSLO, Norge

---

(11) **Reg.nr.:** 083550  
(21) **Søknadsnr.** 20111038  
(73) **Innehaver:** Granberg AS, Innbjoa, 5584  
BJOA, Norge  
(74) **Fullmektig:** Acapo AS, Postboks 1880  
Nordnes, 5817 BERGEN, Norge

---

## Fornyelse av registreringer

(11) **Reg.nr:** 071263 **Fornyhet til:** 2018.02.24  
(73) **Innehaver:** V&S Vin & Sprit AB (publ), 11797, STOCKHOLM, SE  
(74) **Fullmektig:** Zacco Norway AS, Postboks 2003 Vika, 0125, OSLO, NO

---

(11) **Reg.nr:** 071264 **Fornyhet til:** 2018.02.24  
(73) **Innehaver:** V&S Vin & Sprit AB (publ), 11797, STOCKHOLM, SE  
(74) **Fullmektig:** Zacco Norway AS, Postboks 2003 Vika, 0125, OSLO, NO

---

(11) **Reg.nr:** 074868 **Fornyhet til:** 2018.08.06  
(73) **Innehaver:** Beiersdorf AG, Unnastrasse 48, 20245, HAMBURG, DE  
(74) **Fullmektig:** Zacco Norway AS, Postboks 2003 Vika, 0125, OSLO, NO

---

(11) **Reg.nr:** 078199 **Fornyhet til:** 2018.02.21  
(73) **Innehaver:** Arai Helmet (Europe) BV, 10, Zuiderinslag, 3871MR, HOEVELAKEN, NL  
(74) **Fullmektig:** Onsagers AS, Postboks 1813 Vika, 0123, OSLO, NO

---

(11) **Reg.nr:** 078307 **Fornyhet til:** 2018.01.21  
(73) **Innehaver:** Merz & Krell GmbH & Co KGaA, Bahnhofstrasse 76, 64401, GROSS-BIEBERAU, DE  
(74) **Fullmektig:** Onsagers AS, Postboks 1813 Vika, 0123, OSLO, NO

---

(11) **Reg.nr:** 081026 **Fornyhet til:** 2017.12.04  
(73) **Innehaver:** Tod's SpA, Via Filippo Della Valle 1, 63019, SANT'ELPIDIO A MARE, ASCOLI PICENO, IT  
(74) **Fullmektig:** Tandbergs Patentkontor AS, Postboks 1570 Vika, 0118, OSLO, NO  
Fornyelsen gjelder design nr. 1, 3 og 5.

---

(11) **Reg.nr:** 081180 **Fornyhet til:** 2018.01.09  
(73) **Innehaver:** ACO Severin Ahlmann GmbH & Co. KG, Am Ahlmannkai, 24768, RENDSBURG, DE  
(74) **Fullmektig:** Onsagers AS, Postboks 1813 Vika, 0123, OSLO, NO

---

(11) **Reg.nr:** 081219 **Fornyhet til:** 2018.03.07  
(73) **Innehaver:** Laerdal Medical AS, Tanke Svilands gate 30, 4007, STAVANGER, NO  
(74) **Fullmektig:** Onsagers AS, Postboks 1813 Vika, 0123, OSLO, NO

---

(11) **Reg.nr:** 081223 **Fornyhet til:** 2018.03.07  
(73) **Innehaver:** Laerdal Medical AS, Tanke Svilands gate 30, 4007, STAVANGER, NO  
(74) **Fullmektig:** Onsagers AS, Postboks 1813 Vika, 0123, OSLO, NO

---

(11) **Reg.nr:** 081259 **Fornyhet til:** 2018.01.23  
(73) **Innehaver:** Rotork Controls Ltd, Brassmill Lane, BA13QJ, BATH, GB  
(74) **Fullmektig:** Zacco Norway AS, Postboks 2003 Vika, 0125, OSLO, NO

---

(11) **Reg.nr:** 081270 **Fornyhet til:** 2018.02.28  
(73) **Innehaver:** Isokitt Norge AS, Nedre Sarv 8, 4754, BYKLE, NO  
(74) **Fullmektig:** Håmsø Patentbyrå ANS, Postboks 171, 4302, SANDNES, NO

---

(11) **Reg.nr:** 081282 **Fornyhet til:** 2018.01.30  
(73) **Innehaver:** PointPay International Inc, P O Box 561596, FL33256-1596, MIAMI, US  
(74) **Fullmektig:** Bryn Aarflot AS, Postboks 449 Sentrum, 0104, OSLO, NO

---

(11) **Reg.nr:** 081311 **Fornyhet til:** 2018.02.21  
(73) **Innehaver:** Total Hygiene Ltd, 2 Brooklands Road, M333SS, SALE, CHESHIRE, GB  
(74) **Fullmektig:** Zacco Norway AS, Postboks 2003 Vika, 0125, OSLO, NO

---

(11) **Reg.nr:** 081565 **Fornyhet til:** 2018.07.01  
(73) **Innehaver:** Lilleborg AS, Sandakerveien 56, 0477, OSLO, NO  
(74) **Fullmektig:** Zacco Norway AS, Postboks 2003 Vika, 0125, OSLO, NO

---

## Avgjørelse i oppreisningssak

Oppreisning er avvist i designregistrering nr. 080013.