

Norsk

# design tidende

[www.patentstyret.no](http://www.patentstyret.no)

Norsk designtidende er en publikasjon som inneholder kunngjøringer innenfor designområdet

**BESØKSADRESSE**

- ▶ Sandakerveien 64

**POSTADRESSE**

- ▶ Postboks 8160 Dep.  
0033 Oslo

**E-POST**

- ▶ [mail@patentstyret.no](mailto:mail@patentstyret.no)

**TELEFON**

- ▶ 22 38 73 00

**TELEFAKS**

- ▶ 22 38 73 01

**INFOSENTERETS TELEFONTID**

- ▶ kl. 09.00 - 15.00  
Telefon (+47) 22 38 73 33  
Telefaks (+47) 22 38 73 31

## Innholdsfortegnelse:

Registrerte design .....	3
Internasjonale designregistreringer .....	40
Overdragelser .....	72
Endringer i fullmaktsforhold .....	73
Fornyelse av registreringer .....	74

### INID-koder

I kunngjøringene er de enkelte data forsynt med koder overensstemmende med INID-kodesystemet

(INID= Internationally agreed Numbers for the Identification of Data).

- (11) Registreringsnummer
- (15) Registreringsdato
- (18) Dato som registreringen gjelder til
- (21) Søknadsnummer
- (22) Inngivelsesdato
- (24) Løpedag
- (30) Prioritetsopplysninger
- (43) Allment tilgjengelig dato
- (51) Klasse
- (54) Produkt
- (55) Avbildning(er)
- (72) Designer
- (73) Innehaver
- (74) Fullmektig

## Registrerte design

I henhold til designloven § 18 første ledd i.f. kunngjøres i dag følgende registrerte design.

Det kan fremsettes krav om at designregistreringen helt eller delvis skal oppheves, jf. designloven §§ 25 flg. og designforskriften §§ 26 flg.

Designregistreringen gjelder for den eller de periodene på fem år som søknaden er innlevert for, regnet fra søknadsdagen. Registreringen kan fornyes, jf. designloven §§ 23 og 24. Maksimal beskyttelsestid er 25 år. For reservedeler, se unntaket i designloven § 23 annet ledd.

(11)	<b>Reg.nr.:</b>	<b>083145</b>
(21)	<b>Søkn.nr.:</b>	20110418
(22)	<b>Inngitt:</b>	2011.05.24
(24)	<b>Løpedag:</b>	2011.05.24
(43)	<b>Allm. tilgj.:</b>	2011.09.02
(15)	<b>Registrert:</b>	2011.09.02
(45)	<b>Kunngjort:</b>	2011.10.03
(18)	<b>Reg. gjelder til:</b>	2016.05.24
(73)	<b>Innehaver:</b>	Dagfinn Ellingsen, Symrestien 6, 3178 VÅLE
(50)	<b>Anmerkninger:</b>	Registreringen gjelder samregistrering.

### Design 1

(54)	<b>Produkt:</b>	Telysholder
(51)	<b>Klasse:</b>	26-01
(72)	<b>Designer:</b>	Dagfinn Ellingsen, Symrestien 6, 3178 VÅLE
(55)	<b>Designavbildninger:</b>	



1.1



1.2



1.3



1.4



1.5



1.6

**Design 3**

- (54) **Produkt:** Telysholder  
(51) **Klasse:** 26-01  
(72) **Designer:** Dagfinn Ellingsen, Symrestien 6, 3178 VÅLE  
(55) **Designavbildninger:**

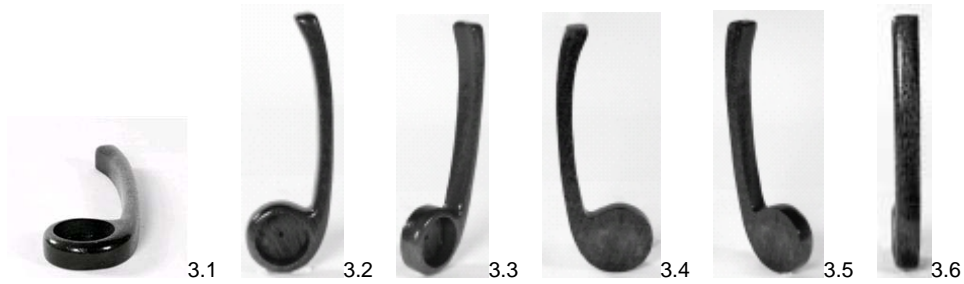
**Design 5**

- (54) **Produkt:** Telysholder  
(51) **Klasse:** 26-01  
(72) **Designer:** Dagfinn Ellingsen, Symrestien 6, 3178 VÅLE  
(55) **Designavbildninger:**



- (11) **Reg.nr.:** 083146  
(21) **Søkn.nr.:** 20110367  
(22) **Inngitt:** 2011.05.02  
(24) **Løpedag:** 2011.05.02  
(43) **Allm. tilgj.:** 2011.05.03  
(15) **Registrert:** 2011.09.05  
(45) **Kunngjort:** 2011.10.03  
(18) **Reg. gjelder til:** 2016.05.02  
(74) **Fullmektig:** Bryn Aarflot AS, Postboks 449 Sentrum, 0104 OSLO  
(73) **Innehaver:** Visa Europe Ltd, 1 Sheldon Square, W26TT LONDON, United Kingdom (GB)  
(50) **Anmerkninger:** Registreringen gjelder samregistrering.

### Design 1

- (54) **Produkt:** Del av kredittkort  
(51) **Klasse:** 19-08  
(72) **Designer:** Monica Meehan, c/o Visa Europe Limited, 1 Sheldon Square, W26TT LONDON, United Kingdom (GB)  
Paul Price, c/o Visa Europe Limited, 1 Sheldon Square, W26TT LONDON, United Kingdom (GB)  
Alistair Cubacub, c/o Visa Europe Limited, 1 Sheldon Square, W26TT LONDON, United Kingdom (GB)  
(30) **Prioritet:** 2010.11.03, EM, 001776386  
(55) **Designavbildninger:**

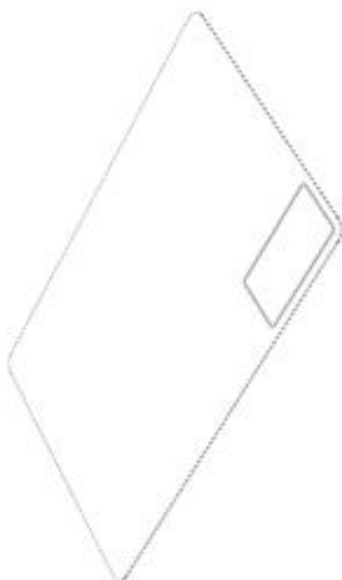

1.1



1.2



1.3



1.4

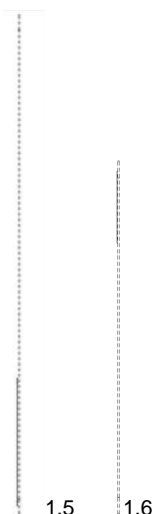

1.5



1.6



1.7

**Design 2**

- (54) **Produkt:** Del av kredittkort  
(51) **Klasse:** 19-08  
(72) **Designer:** Monica Meehan, c/o Visa Europe Limited, 1 Sheldon Square, W26TT LONDON, United Kingdom (GB)  
Paul Price, c/o Visa Europe Limited, 1 Sheldon Square, W26TT LONDON, United Kingdom (GB)  
Alistair Cubacub, c/o Visa Europe Limited, 1 Sheldon Square, W26TT LONDON, United Kingdom (GB)  
(30) **Prioritet:** 2010.11.03, EM, 001776386  
(55) **Designavbildninger:**



2.1



2.2

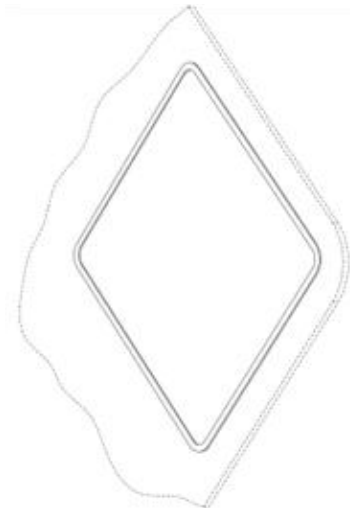

2.3



2.4



2.5



2.6



2.7

(11)	<b>Reg.nr.:</b>	<b>083147</b>
(21)	<b>Søkn.nr.:</b>	20110477
(22)	<b>Inngitt:</b>	2011.06.09
(24)	<b>Løpedag:</b>	2011.06.09
(43)	<b>Allm. tilgj.:</b>	2011.06.15
(15)	<b>Registrert:</b>	2011.09.05
(45)	<b>Kunngjort:</b>	2011.10.03
(18)	<b>Reg. gjelder til:</b>	2016.06.09
(74)	<b>Fullmektig:</b>	Zacco Norway AS, Postboks 2003 Vika, 0125 OSLO
(73)	<b>Innehaver:</b>	Société des Produits Nestlé SA, 1800 VEVEY, Sveits (CH)

**Design 1**

(54)	<b>Produkt:</b>	Dispenser for kapsler til kaffemaskin
(51)	<b>Klasse:</b>	07-99
(72)	<b>Designer:</b>	Frank Rousselin, c/o Phi Design Parc Economique Champfeuillet 9 Chemin des Essartes, 38500 VOIRON, Frankrike (FR)
(30)	<b>Prioritet:</b>	2010.12.15, CH, 1374/85
(55)	<b>Designavbildninger:</b>	

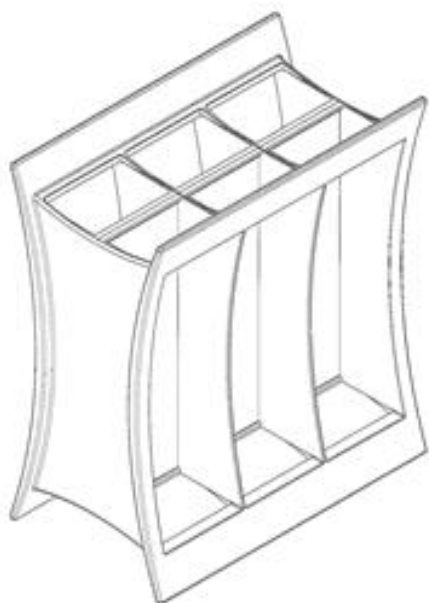

1.1

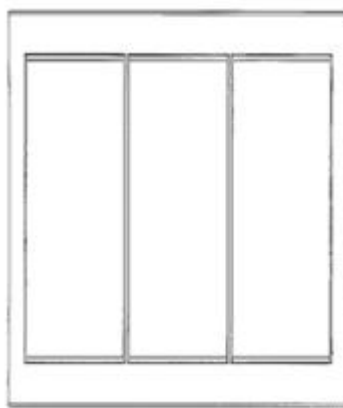

1.2

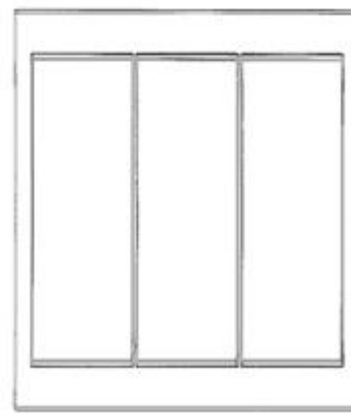

1.3

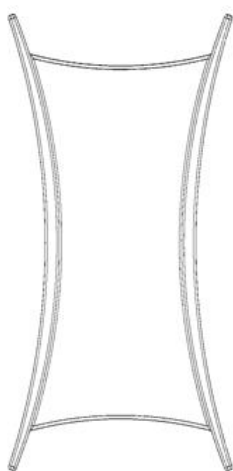

1.4



1.5

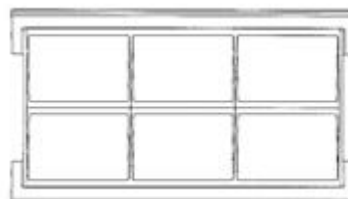

1.6

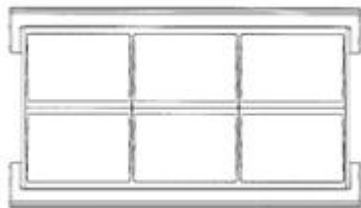

1.7



(11)	<b>Reg.nr.:</b>	<b>083148</b>
(21)	<b>Søkn.nr.:</b>	20110545
(22)	<b>Inngitt:</b>	2011.06.23
(24)	<b>Løpedag:</b>	2011.06.23
(43)	<b>Allm. tilgj.:</b>	2011.07.21
(15)	<b>Registrert:</b>	2011.09.05
(45)	<b>Kunngjort:</b>	2011.10.03
(18)	<b>Reg. gjelder til:</b>	2016.06.23
(74)	<b>Fullmektig:</b>	Onsagers AS, Postboks 6963 St Olavs Plass, 0130 OSLO
(73)	<b>Innehaver:</b>	Mars Inc, 6885 Elm Street, VA22101-3883 MCLEAN, USA (US)
(50)	<b>Anmerkninger:</b>	Lagt inn anmerkning.

**Design 1**

(54)	<b>Produkt:</b>	Sjokolade
(51)	<b>Klasse:</b>	01-01
(72)	<b>Designer:</b>	Bruce Hannant, Flat 9, 171 Queenstown Road, SW83RL BATTERSEA, LONDON, Storbritannia (GB) Seb Gwyther, 5 Host Street, BS15BU BRISTOL, Storbritannia (GB) Chris Weston, 2 Lansdown Mews, BA15DY BATH, Storbritannia (GB) Crystal Lieuw On, Mars Nederland BV, Taylorweg 5, 5466AE VEGHEL, Nederland (NL)
(30)	<b>Prioritet:</b>	2011.01.21, EM, 001256028
(50)	<b>Anmerkning:</b>	Designen er i farger.
(55)	<b>Designavbildninger:</b>	



1.1



1.2



1.3



1.4



1.5



1.6



1.7

(11)	<b>Reg.nr.:</b>	<b>083149</b>
(21)	<b>Søkn.nr.:</b>	20110483
(22)	<b>Inngitt:</b>	2011.06.15
(24)	<b>Løpedag:</b>	2011.06.15
(43)	<b>Allm. tilgj.:</b>	2011.09.05
(15)	<b>Registrert:</b>	2011.09.05
(45)	<b>Kunngjort:</b>	2011.10.03
(18)	<b>Reg. gjelder til:</b>	2016.06.15
(74)	<b>Fullmektig:</b>	Onsagers AS, Postboks 6963 St Olavs Plass, 0130 OSLO
(73)	<b>Innehaver:</b>	Mars Inc, 6885 Elm Street, VA22101-3883 MCLEAN, United States of America (US)
(50)	<b>Anmerkninger:</b>	Registreringen gjelder samregistrering.

**Design 1**

(54)	<b>Produkt:</b>	Beholder for næringsmidler
(51)	<b>Klasse:</b>	09-01
(72)	<b>Designer:</b>	Darren Foley, 50 Brook Green, W67BJ LONDON, United Kingdom (GB) Yael Alaton, 50 Brook Green, W67BJ LONDON, United Kingdom (GB) Shaun Bowen, 50 Brook Green, W67BJ LONDON, United Kingdom (GB) Wybe Magermans, 50 Brook Green, W67BJ LONDON, United Kingdom (GB) Claudio Vecchio, 50 Brook Green, W67BJ LONDON, United Kingdom (GB) Jonathan Shaw, 50 Brook Green, W67BJ LONDON, United Kingdom (GB) Lyndon Povey, 50 Brook Green, W67BJ LONDON, United Kingdom (GB)
(30)	<b>Prioritet:</b>	2011.03.01, EM, 001263248
(55)	<b>Designavbildninger:</b>	



1.1



1.2

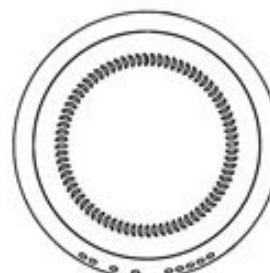

1.3

**Design 2**

(54)	<b>Produkt:</b>	Beholder for næringsmidler
(51)	<b>Klasse:</b>	09-01
(72)	<b>Designer:</b>	Darren Foley, 50 Brook Green, W67BJ LONDON, United Kingdom (GB) Yael Alaton, 50 Brook Green, W67BJ LONDON, United Kingdom (GB) Shaun Bowen, 50 Brook Green, W67BJ LONDON, United Kingdom (GB) Wybe Magermans, 50 Brook Green, W67BJ LONDON, United Kingdom (GB) Claudio Vecchio, 50 Brook Green, W67BJ LONDON, United Kingdom (GB) Jonathan Shaw, 50 Brook Green, W67BJ LONDON, United Kingdom (GB) Lyndon Povey, 50 Brook Green, W67BJ LONDON, United Kingdom (GB)
(30)	<b>Prioritet:</b>	2011.03.01, EM, 001263248
(55)	<b>Designavbildninger:</b>	

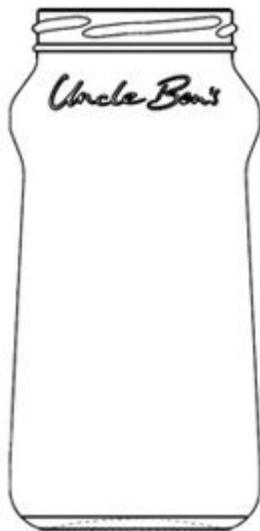

2.1



2.2

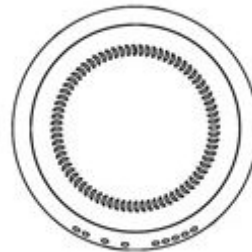

2.3

**Design 3**(54) **Produkt:**

Beholder for næringsmidler

(51) **Klasse:**

09-01

(72) **Designer:**

Darren Foley, 50 Brook Green, W67BJ LONDON, United Kingdom (GB)  
 Yael Alaton, 50 Brook Green, W67BJ LONDON, United Kingdom (GB)  
 Shaun Bowen, 50 Brook Green, W67BJ LONDON, United Kingdom (GB)  
 Wybe Magermans, 50 Brook Green, W67BJ LONDON, United Kingdom (GB)  
 Claudio Vecchio, 50 Brook Green, W67BJ LONDON, United Kingdom (GB)  
 Jonathan Shaw, 50 Brook Green, W67BJ LONDON, United Kingdom (GB)  
 Lyndon Povey, 50 Brook Green, W67BJ LONDON, United Kingdom (GB)

(30) **Prioritet:**

2011.03.01, EM, 001263248

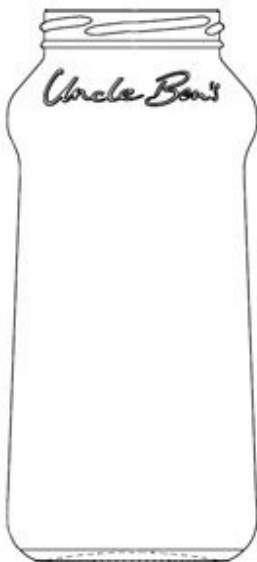
(55) **Designavbildninger:**

3.1



3.2

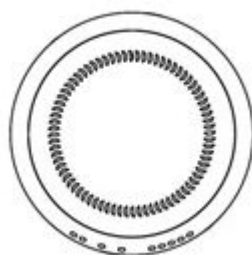

3.3

(11)	<b>Reg.nr.:</b>	<b>083150</b>
(21)	<b>Søkn.nr.:</b>	20110496
(22)	<b>Inngitt:</b>	2011.06.24
(24)	<b>Løpedag:</b>	2011.06.24
(43)	<b>Allm. tilgj.:</b>	2011.09.06
(15)	<b>Registrert:</b>	2011.09.06
(45)	<b>Kunngjort:</b>	2011.10.03
(18)	<b>Reg. gjelder til:</b>	2016.06.24
(73)	<b>Innehaver:</b>	Haugen Alliansen AS, Hettebakkvn 160, 5131 NYBORG
(50)	<b>Anmerkninger:</b>	Registreringen gjelder samregistrering.

### Design 1

(54)	<b>Produkt:</b>	Ring
(51)	<b>Klasse:</b>	11-01
(72)	<b>Designer:</b>	Stein Kjetil Haugen, Hettebakkv. 160, 5131 NYBORG
(55)	<b>Designavbildninger:</b>	



1.1

### Design 2

(54)	<b>Produkt:</b>	Ring
(51)	<b>Klasse:</b>	11-01
(72)	<b>Designer:</b>	Stein Kjetil Haugen, Hettebakkv. 160, 5131 NYBORG
(55)	<b>Designavbildninger:</b>	



2.1

(11) **Reg.nr.:** 083151  
(21) **Søkn.nr.:** 20110416  
(22) **Inngitt:** 2011.05.25  
(24) **Løpedag:** 2011.05.25  
(43) **Allm. tilgj.:** 2011.09.04  
(15) **Registrert:** 2011.09.08  
(45) **Kunngjort:** 2011.10.03  
(18) **Reg. gjelder til:** 2016.05.25  
(74) **Fullmektig:** Oslo Patentkontor AS, Postboks 7007 Majorstua , 0306 OSLO  
(73) **Innehaber:** Bang & Olufsen A/S, Peter Bangs Vej 15, 7600 STRUER, Danmark (DK)

### Design 1

(54) **Produkt:** Fjernsynsapparat  
(51) **Klasse:** 14-03  
(72) **Designer:** David Lewis, Blegdamsvej 28D, 2200 KØBENHAVN N, Danmark (DK)  
(30) **Prioritet:** 2011.03.04, DK, 2011 00038, 1  
(55) **Designavbildninger:**

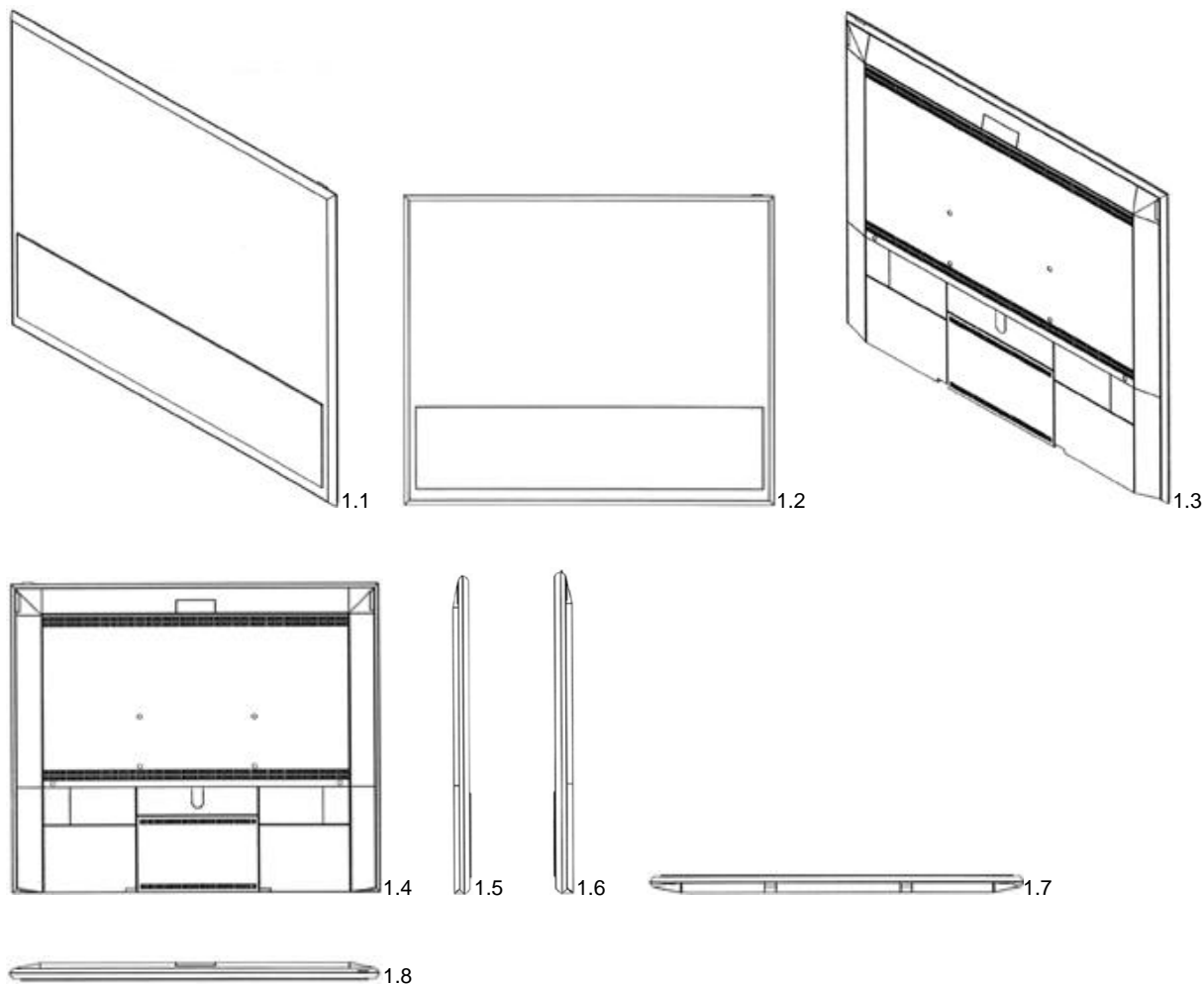

(11)	<b>Reg.nr.:</b>	<b>083152</b>
(21)	<b>Søkn.nr.:</b>	20110146
(22)	<b>Inngitt:</b>	2011.03.03
(24)	<b>Løpedag:</b>	2011.03.03
(43)	<b>Allm. tilgj.:</b>	2011.09.03
(15)	<b>Registrert:</b>	2011.09.08
(45)	<b>Kunngjort:</b>	2011.10.03
(18)	<b>Reg. gjelder til:</b>	2016.03.03
(74)	<b>Fullmektig:</b>	Advokat Gunnar Krogstad, Postboks 251 Sentrum, 7401 TRONDHEIM
(73)	<b>Innehaver:</b>	Stein Hofstad, Jonsvannsv 140, 7048 TRONDHEIM

### Design 1

(54)	<b>Produkt:</b>	Skillevegg til depotvogn
(51)	<b>Klasse:</b>	12-02
(72)	<b>Designer:</b>	Stein Hofstad, Jonsvannsv 140, 7048 TRONDHEIM
(55)	<b>Designavbildninger:</b>	

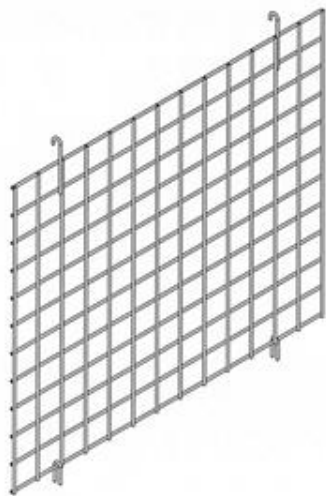

1.1

---

(11)	<b>Reg.nr.:</b>	<b>083153</b>
(21)	<b>Søkn.nr.:</b>	20110147
(22)	<b>Inngitt:</b>	2011.03.03
(24)	<b>Løpedag:</b>	2011.03.03
(43)	<b>Allm. tilgj.:</b>	2011.09.03
(15)	<b>Registrert:</b>	2011.09.08
(45)	<b>Kunngjort:</b>	2011.10.03
(18)	<b>Reg. gjelder til:</b>	2016.03.03
(74)	<b>Fullmektig:</b>	Advokat Gunnar Krogstad, Postboks 251 Sentrum, 7401 TRONDHEIM
(73)	<b>Innehaver:</b>	Stein Hofstad, Jonsvannsv 140, 7048 TRONDHEIM

### Design 1

(54)	<b>Produkt:</b>	Drag til depotvogn
(51)	<b>Klasse:</b>	12-02
(72)	<b>Designer:</b>	Stein Hofstad, Jonsvannsv 140, 7048 TRONDHEIM
(55)	<b>Designavbildninger:</b>	



1.1

(11)	<b>Reg.nr.:</b>	<b>083154</b>
(21)	<b>Søkn.nr.:</b>	20110148
(22)	<b>Inngitt:</b>	2011.03.03
(24)	<b>Løpedag:</b>	2011.03.03
(43)	<b>Allm. tilgj.:</b>	2011.09.03
(15)	<b>Registrert:</b>	2011.09.08
(45)	<b>Kunngjort:</b>	2011.10.03
(18)	<b>Reg. gjelder til:</b>	2016.03.03
(74)	<b>Fullmektig:</b>	Advokat Gunnar Krogstad, Postboks 251 Sentrum, 7401 TRONDHEIM
(73)	<b>Innehaber:</b>	Stein Hofstad, Jonsvannsv 140, 7048 TRONDHEIM

### Design 1

(54)	<b>Produkt:</b>	Garderobestang til depotvogn
(51)	<b>Klasse:</b>	12-02
(72)	<b>Designer:</b>	Stein Hofstad, Jonsvannsv 140, 7048 TRONDHEIM
(55)	<b>Designavbildninger:</b>	



1.1

---

(11)	<b>Reg.nr.:</b>	<b>083155</b>
(21)	<b>Søkn.nr.:</b>	20110400
(22)	<b>Inngitt:</b>	2011.05.16
(24)	<b>Løpedag:</b>	2011.05.16
(43)	<b>Allm. tilgj.:</b>	2011.08.22
(15)	<b>Registrert:</b>	2011.09.09
(45)	<b>Kunngjort:</b>	2011.10.03
(18)	<b>Reg. gjelder til:</b>	2016.05.16
(74)	<b>Fullmektig:</b>	Zacco Norway AS, Postboks 2003 Vika, 0125 OSLO
(73)	<b>Innehaber:</b>	Continental Reifen Deutschland GmbH, Vahrenwalder Str. 9, 30163 HANNOVER, Tyskland (DE)

### Design 1

(54)	<b>Produkt:</b>	Slitebane for dekk
(51)	<b>Klasse:</b>	12-15
(72)	<b>Designer:</b>	Ulrich Vermehr, Roonstr. 14, 30163 HANNOVER, Tyskland (DE)
(30)	<b>Prioritet:</b>	2011.02.22, EM, 001824350
(55)	<b>Designavbildninger:</b>	



1.1

(11)	<b>Reg.nr.:</b>	<b>083156</b>
(21)	<b>Søkn.nr.:</b>	20110139
(22)	<b>Inngitt:</b>	2011.02.24
(24)	<b>Løpedag:</b>	2011.02.24
(43)	<b>Allm. tilgj.:</b>	2011.08.24
(15)	<b>Registrert:</b>	2011.09.09
(45)	<b>Kunngjort:</b>	2011.10.03
(18)	<b>Reg. gjelder til:</b>	2016.02.24
(74)	<b>Fullmektig:</b>	Bryn Aarflot AS, Postboks 449 Sentrum, 0104 OSLO
(73)	<b>Innehaver:</b>	Tine SA, Dronning Eufemias gate 6, 0191 OSLO
(50)	<b>Anmerkninger:</b>	Design nr. 2, 4, 6, 8, 10, 12, 14, og 16 er i farger.

Registreringen gjelder samregistrering.

### Design 1

(54)	<b>Produkt:</b>	Ornament
(51)	<b>Klasse:</b>	32-00
(72)	<b>Designer:</b>	Bjørn Rybakken, c/o Tangram Design, Holbergs gate 21, 0166 OSLO
(55)	<b>Designavbildninger:</b>	



### Design 2

(54)	<b>Produkt:</b>	Ornament
(51)	<b>Klasse:</b>	32-00
(72)	<b>Designer:</b>	Bjørn Rybakken, c/o Tangram Design, Holbergs gate 21, 0166 OSLO
(50)	<b>Anmerkning:</b>	Designen er i farger.
(55)	<b>Designavbildninger:</b>	





**Design 3**

(54)	<b>Produkt:</b>	Ornament
(51)	<b>Klasse:</b>	32-00
(72)	<b>Designer:</b>	Bjørn Rybakken, c/o Tangram Design, Holbergs gate 21, 0166 OSLO
(55)	<b>Designavbildninger:</b>	

**Design 4**

(54)	<b>Produkt:</b>	Ornament
(51)	<b>Klasse:</b>	32-00
(72)	<b>Designer:</b>	Bjørn Rybakken, c/o Tangram Design, Holbergs gate 21, 0166 OSLO
(50)	<b>Anmerkning:</b>	Designen er i farger.
(55)	<b>Designavbildninger:</b>	



**Design 5**

(54)	<b>Produkt:</b>	Ornament
(51)	<b>Klasse:</b>	32-00
(72)	<b>Designer:</b>	Bjørn Rybakken, c/o Tangram Design, Holbergs gate 21, 0166 OSLO
(55)	<b>Designavbildninger:</b>	



5.1

**Design 6**

(54)	<b>Produkt:</b>	Ornament
(51)	<b>Klasse:</b>	32-00
(72)	<b>Designer:</b>	Bjørn Rybakken, c/o Tangram Design, Holbergs gate 21, 0166 OSLO
(50)	<b>Anmerkning:</b>	Designen er i farger.
(55)	<b>Designavbildninger:</b>	



6.1

**Design 7**

(54)	<b>Produkt:</b>	Ornament
(51)	<b>Klasse:</b>	32-00
(72)	<b>Designer:</b>	Bjørn Rybakken, c/o Tangram Design, Holbergs gate 21, 0166 OSLO
(55)	<b>Designavbildninger:</b>	

**Design 8**

(54)	<b>Produkt:</b>	Ornament
(51)	<b>Klasse:</b>	32-00
(72)	<b>Designer:</b>	Bjørn Rybakken, c/o Tangram Design, Holbergs gate 21, 0166 OSLO
(50)	<b>Anmerkning:</b>	Designen er i farger.
(55)	<b>Designavbildninger:</b>	



**Design 9**

- (54) **Produkt:** Ornamment  
(51) **Klasse:** 32-00  
(72) **Designer:** Bjørn Rybakken, c/o Tangram Design, Holbergs gate 21, 0166 OSLO  
(55) **Designavbildninger:**

**Design 10**

- (54) **Produkt:** Ornamment  
(51) **Klasse:** 32-00  
(72) **Designer:** Bjørn Rybakken, c/o Tangram Design, Holbergs gate 21, 0166 OSLO  
(50) **Anmerkning:** Designen er i farger.  
(55) **Designavbildninger:**



**Design 11**

(54)	<b>Produkt:</b>	Ornament
(51)	<b>Klasse:</b>	32-00
(72)	<b>Designer:</b>	Bjørn Rybakken, c/o Tangram Design, Holbergs gate 21, 0166 OSLO
(55)	<b>Designavbildninger:</b>	

**Design 12**

(54)	<b>Produkt:</b>	Ornament
(51)	<b>Klasse:</b>	32-00
(72)	<b>Designer:</b>	Bjørn Rybakken, c/o Tangram Design, Holbergs gate 21, 0166 OSLO
(50)	<b>Anmerkning:</b>	Designen er i farger.
(55)	<b>Designavbildninger:</b>	



**Design 13**

(54)	<b>Produkt:</b>	Ornament
(51)	<b>Klasse:</b>	32-00
(72)	<b>Designer:</b>	Bjørn Rybakken, c/o Tangram Design, Holbergs gate 21, 0166 OSLO
(55)	<b>Designavbildninger:</b>	



13.1

**Design 14**

(54)	<b>Produkt:</b>	Ornament
(51)	<b>Klasse:</b>	32-00
(72)	<b>Designer:</b>	Bjørn Rybakken, c/o Tangram Design, Holbergs gate 21, 0166 OSLO
(50)	<b>Anmerkning:</b>	Designen er i farger.
(55)	<b>Designavbildninger:</b>	



14.1

**Design 15**

- (54) **Produkt:** Ornamment  
(51) **Klasse:** 32-00  
(72) **Designer:** Bjørn Rybakken, c/o Tangram Design, Holbergs gate 21, 0166 OSLO  
(55) **Designavbildninger:**



15.1

**Design 16**

- (54) **Produkt:** Ornamment  
(51) **Klasse:** 32-00  
(72) **Designer:** Bjørn Rybakken, c/o Tangram Design, Holbergs gate 21, 0166 OSLO  
(50) **Anmerkning:** Designen er i farger.  
(55) **Designavbildninger:**



16.1

(11)	<b>Reg.nr.:</b>	<b>083157</b>
(21)	<b>Søkn.nr.:</b>	20110561
(22)	<b>Inngitt:</b>	2011.07.12
(24)	<b>Løpedag:</b>	2011.07.12
(43)	<b>Allm. tilgj.:</b>	2011.08.01
(15)	<b>Registrert:</b>	2011.09.13
(45)	<b>Kunngjort:</b>	2011.10.03
(18)	<b>Reg. gjelder til:</b>	2016.07.12
(74)	<b>Fullmektig:</b>	Zacco Norway AS, Postboks 2003 Vika, 0125 OSLO
(73)	<b>Innehaber:</b>	Société des Produits Nestlé SA, 1800 VEVEY, Sveits (CH)

**Design 1**

(54)	<b>Produkt:</b>	Kopp
(51)	<b>Klasse:</b>	07-01
(72)	<b>Designer:</b>	Antoine Cahen, Place du Nord 2, 1005 LAUSANNE, Sveits (CH)
(30)	<b>Prioritet:</b>	2011.02.01, CH, 137588
(55)	<b>Designavbildninger:</b>	





(11)	<b>Reg.nr.:</b>	<b>083158</b>
(21)	<b>Søkn.nr.:</b>	20110563
(22)	<b>Inngitt:</b>	2011.07.12
(24)	<b>Løpedag:</b>	2011.07.12
(43)	<b>Allm. tilgj.:</b>	2011.08.15
(15)	<b>Registrert:</b>	2011.09.13
(45)	<b>Kunngjort:</b>	2011.10.03
(18)	<b>Reg. gjelder til:</b>	2016.07.12
(74)	<b>Fullmektig:</b>	Zacco Norway AS, Postboks 2003 Vika, 0125 OSLO
(73)	<b>Innehaber:</b>	Société des Produits Nestlé SA, 1800 VEVEY, Sveits (CH)

**Design 1**

(54)	<b>Produkt:</b>	Kaffemaskin
(51)	<b>Klasse:</b>	07-02
(72)	<b>Designer:</b>	Antoine Cahen, Place du Nord 2, 1005 LAUSANNE, Sveits (CH)
(30)	<b>Prioritet:</b>	2011.02.15, CH, 137632
(55)	<b>Designavbildninger:</b>	



1.1



1.2



1.3



1.4



1.5



1.6



1.7

- (11) **Reg.nr.:** 083159  
(21) **Søkn.nr.:** 20110422  
(22) **Inngitt:** 2011.05.27  
(24) **Løpedag:** 2011.05.27  
(43) **Allm. tilgj.:** 2011.05.27  
(15) **Registrert:** 2011.09.13  
(45) **Kunngjort:** 2011.10.03  
(18) **Reg. gjelder til:** 2016.05.27  
(73) **Innehaver:** Frank Ralle, Infanteriveien 10, 3733 SKIEN  
(50) **Anmerkninger:** Designene er i farger.  
Registreringen gjelder samregistrering.

### Design 1

- (54) **Produkt:** Profil for å hindre dannelse av istapper i takrenner  
(51) **Klasse:** 23-01  
(72) **Designer:** Frank Ralle, Infanteriveien 10, 3733 SKIEN  
(50) **Anmerkning:** Designen er i farger.  
(55) **Designavbildninger:**

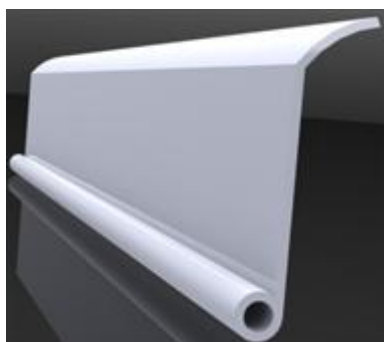

1.1

### Design 2

- (54) **Produkt:** Profil for å hindre dannelse av istapper i takrenner  
(51) **Klasse:** 23-01  
(72) **Designer:** Frank Ralle, Infanteriveien 10, 3733 SKIEN  
(50) **Anmerkning:** Designen er i farger.  
(55) **Designavbildninger:**

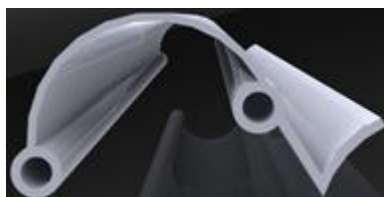

2.1

(11)	<b>Reg.nr.:</b>	<b>083160</b>
(21)	<b>Søkn.nr.:</b>	20110472
(22)	<b>Inngitt:</b>	2011.06.01
(24)	<b>Løpedag:</b>	2011.06.01
(43)	<b>Allm. tilgj.:</b>	2011.06.01
(15)	<b>Registrert:</b>	2011.09.14
(45)	<b>Kunngjort:</b>	2011.10.03
(18)	<b>Reg. gjelder til:</b>	2016.06.01
(74)	<b>Fullmektig:</b>	Bryn Aarflot AS, Postboks 449 Sentrum, 0104 OSLO
(73)	<b>Innehaver:</b>	Fitness Brands 2 LLC, 3400 Ranch Rd. 620 South, #12101, TX78738 AUSTIN, USA (US)

**Design 1**

(54)	<b>Produkt:</b>	Buktreningsanordning
(51)	<b>Klasse:</b>	21-02
(72)	<b>Designer:</b>	David Brodess, 129 Sebastian's Run, TX 78738 AUSTIN, USA (US) Michael Casey, 900 Ranch Road 620 S., Suite 202-101, TX78734 AUSTIN, USA (US)
(30)	<b>Prioritet:</b>	2010.12.01, US, 29/380,225
(55)	<b>Designavbildninger:</b>	



1.1

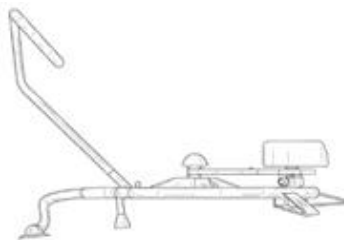

1.2

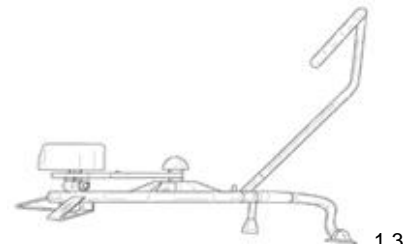

1.3

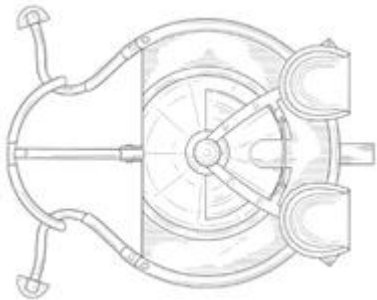

1.4

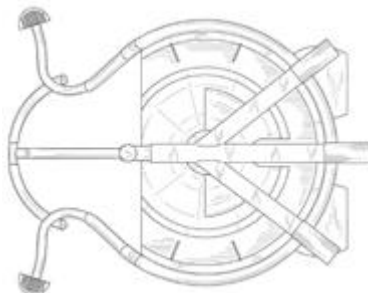

1.5

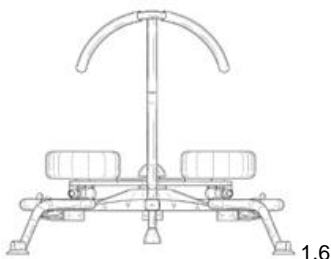

1.6

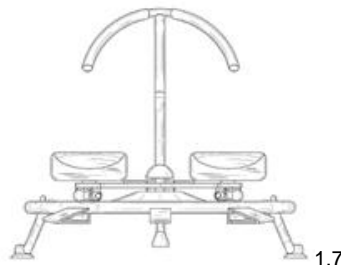

1.7

- (11) **Reg.nr.:** 083161  
 (21) **Søkn.nr.:** 20110568  
 (22) **Inngitt:** 2011.07.15  
 (24) **Løpedag:** 2011.07.15  
 (43) **Allm. tilgj.:** 2011.09.14  
 (15) **Registrert:** 2011.09.14  
 (45) **Kunngjort:** 2011.10.03  
 (18) **Reg. gjelder til:** 2016.07.15  
 (73) **Inneholder:** Flugger A/S, Islevdalvej 151, 2610 RØDOVRE, Danmark (DK)  
 (50) **Anmerkninger:** Registreringen gjelder samregistrering.

**Design 1**

- (54) **Produkt:** Malepensel  
 (51) **Klasse:** 04-04  
 (72) **Designer:** Helle Tranberg Lund, Islevdalvej 151, 2610 RØDOVRE, Danmark (DK)  
 Anne Christensen, Islevdalvej 151, 2610 RØDOVRE, Danmark (DK)  
 Niels Bartholin, Islevdalvej 151, 2610 RØDOVRE, Danmark (DK)  
 Lukasz Kos, Islevdalvej 151, 2610 RØDOVRE, Danmark (DK)

(55) **Designavbildninger:**

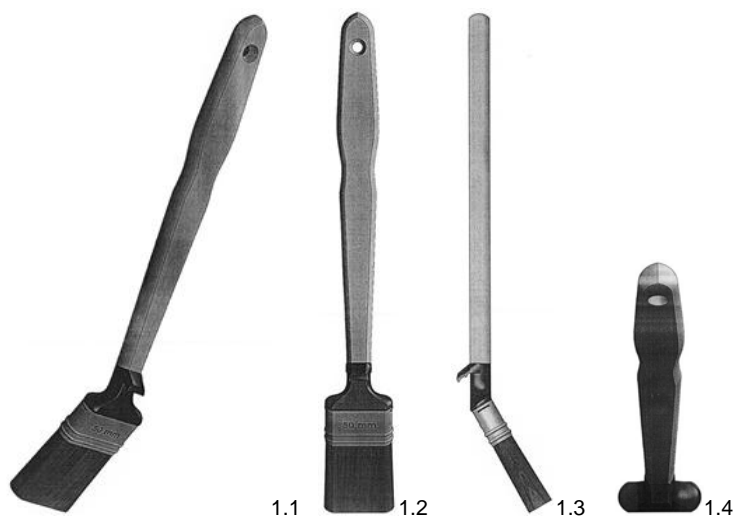
**Design 2**

- (54) **Produkt:** Malepensel  
 (51) **Klasse:** 04-04  
 (72) **Designer:** Helle Tranberg Lund, Islevdalvej 151, 2610 RØDOVRE, Danmark (DK)  
 Anne Christensen, Islevdalvej 151, 2610 RØDOVRE, Danmark (DK)  
 Niels Bartholin, Islevdalvej 151, 2610 RØDOVRE, Danmark (DK)  
 Lukasz Kos, Islevdalvej 151, 2610 RØDOVRE, Danmark (DK)

(55) **Designavbildninger:**

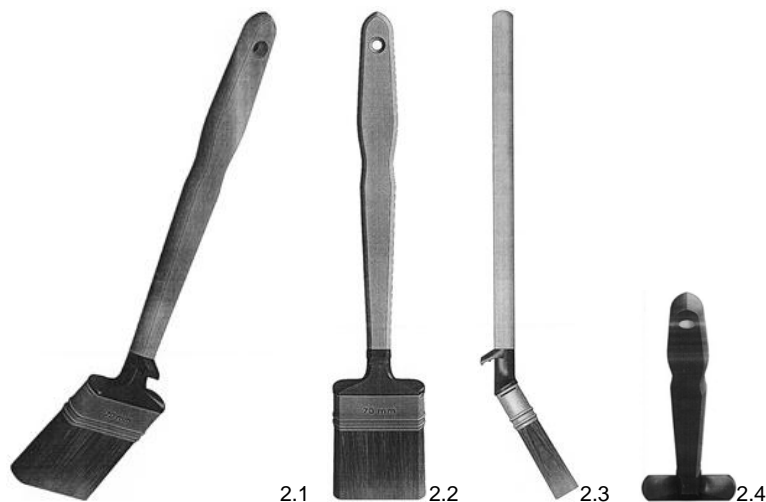

(11)	<b>Reg.nr.:</b>	<b>083162</b>
(21)	<b>Søkn.nr.:</b>	20110278
(22)	<b>Inngitt:</b>	2011.04.26
(24)	<b>Løpedag:</b>	2011.04.26
(43)	<b>Allm. tilgj.:</b>	2011.04.26
(15)	<b>Registrert:</b>	2011.09.15
(45)	<b>Kunngjort:</b>	2011.10.03
(18)	<b>Reg. gjelder til:</b>	2016.04.26
(74)	<b>Fullmektig:</b>	Zacco Norway AS, Postboks 2003 Vika, 0125 OSLO
(73)	<b>Innehaber:</b>	Société des Produits Nestlé SA, 1800 VEVEY, Sveits (CH)

**Design 1**

(54)	<b>Produkt:</b>	Maskin for tilberedning av drikke
(51)	<b>Klasse:</b>	07-02
(72)	<b>Designer:</b>	Pierre Struzka, c/o Multiple SA, Ruelle des Buissons 1, 23000 LA CHAUX-DE-FONDS, Sveits (CH)
(30)	<b>Prioritet:</b>	2010.11.01, CH, 137346
(55)	<b>Designavbildninger:</b>	



1.1



1.2



1.3



1.4



1.5



1.6



1.7

- (11) **Reg.nr.:** 083163  
 (21) **Søkn.nr.:** 20110264  
 (22) **Inngitt:** 2011.04.13  
 (24) **Løpedag:** 2011.04.13  
 (43) **Allm. tilgj.:** 2011.04.19  
 (15) **Registrert:** 2011.09.15  
 (45) **Kunngjort:** 2011.10.03  
 (18) **Reg. gjelder til:** 2016.04.13  
 (74) **Fullmektig:** Protector Intellectual Property Consultants AS, Oscarsgate 20, 0352 OSLO  
 (73) **Innehaver:** Apple Inc, 1 Infinite Loop, CA95014 CUPERTINO, USA (US)  
 (50) **Anmerkninger:** Det er foretatt supplerende undersøkelse.

### Design 1

- (54) **Produkt:** Elektronisk anordning for databehandling  
 (51) **Klasse:** 14-02  
 (72) **Designer:** Jody Akana, 1 Infinite Loop, MS 302-1ID, CA95014 CUPERTINO, USA (US)  
 Bartley K Andre, 1 Infinite Loop, MS 302-1ID, CA95014 CUPERTINO, USA (US)  
 Daniel J Coster, 1 Infinite Loop MS 302-1ID, CA95014 CUPERTINO, USA (US)  
 Daniele De Iuliis, 1 Infinite Loop, MS 302-1ID, CA95014 CUPERTINO, USA (US)  
 Evans Hankey, 1 Infinite Loop, MS 302-1ID, CA95014 CUPERTINO, USA (US)  
 Richard P Howarth, 1 Infinite Loop, MS 302-1ID, CA95014 CUPERTINO, USA (US)  
 Jonathan P Ive, 1 Infinite Loop, MS 302-1ID, CA95014 CUPERTINO, USA (US)  
 Duncan Robert Kerr, 1 Infinite Loop, MS 302-1ID, CA95014 CUPERTINO, USA (US)  
 Shin Nishibori, 1 Infinite Loop, MS 302-1ID, CA95014 CUPERTINO, USA (US)  
 Matthew Dean Rohrbach, 1 Infinite Loop, MS 302-1ID, CA95014 CUPERTINO, USA (US)  
 Peter Russell-Clarke, 1 Infinite Loop, MS 302-1ID, CA95014 CUPERTINO, USA (US)  
 Christopher J Stringer, 1 Infinite Loop, MS 302-1ID, CA95014 CUPERTINO, USA (US)  
 Eugene Antony Whang, 1 Infinite Loop, MS 302-1ID, CA95014 CUPERTINO, USA (US)  
 Rico Zorkendorfer, 1 Infinite Loop, MS 302-1ID, CA95014 CUPERTINO, USA (US)  
 Jeremy Bataillou, 1 Infinite Loop, MS 302-1ID, CA95014 CUPERTINO, USA (US)  
 (30) **Prioritet:** 2010.10.19, US, 29/377,271  
 (55) **Designavbildninger:**



1.1



1.2



1.3



1.4



1.5



1.6



1.7



1.8



1.9



1.10



1.11



1.12



1.13



1.14

(11)	<b>Reg.nr.:</b>	<b>083164</b>
(21)	<b>Søkn.nr.:</b>	20110265
(22)	<b>Inngitt:</b>	2011.04.13
(24)	<b>Løpedag:</b>	2011.04.13
(43)	<b>Allm. tilgj.:</b>	2011.04.19
(15)	<b>Registrert:</b>	2011.09.15
(45)	<b>Kunngjort:</b>	2011.10.03
(18)	<b>Reg. gjelder til:</b>	2016.04.13
(74)	<b>Fullmektig:</b>	Protector Intellectual Property Consultants AS, Oscarsgate 20, 0352 OSLO
(73)	<b>Innehaver:</b>	Apple Inc, 1 Infinite Loop, CA95014 CUPERTINO, USA (US)
(50)	<b>Anmerkninger:</b>	Det er foretatt supplerende undersøkelse.

**Design 1**

(54)	<b>Produkt:</b>	Elektronisk anordning for databehandling
(51)	<b>Klasse:</b>	14-02
(72)	<b>Designer:</b>	Jody Akana, 1 Infinite Loop, MS 302-1ID, CA95014 CUPERTINO, USA (US) Bartley K Andre, 1 Infinite Loop, MS 302-1ID, CA95014 CUPERTINO, USA (US) Daniel J Coster, 1 Infinite Loop MS 302-1ID, CA95014 CUPERTINO, USA (US) Daniele De Iulii, 1 Infinite Loop, MS 302-1ID, CA95014 CUPERTINO, USA (US) Evans Hankey, 1 Infinite Loop, MS 302-1ID, CA95014 CUPERTINO, USA (US) Richard P Howarth, 1 Infinite Loop, MS 302-1ID, CA95014 CUPERTINO, USA (US) Jonathan P Ive, 1 Infinite Loop, MS 302-1ID, CA95014 CUPERTINO, USA (US) Duncan Robert Kerr, 1 Infinite Loop, MS 302-1ID, CA95014 CUPERTINO, USA (US) Shin Nishibori, 1 Infinite Loop, MS 302-1ID, CA95014 CUPERTINO, USA (US) Matthew Dean Rohrbach, 1 Infinite Loop, MS 302-1ID, CA95014 CUPERTINO, USA (US) Peter Russell-Clarke, 1 Infinite Loop, MS 302-1ID, CA95014 CUPERTINO, USA (US) Christopher J Stringer, 1 Infinite Loop, MS 302-1ID, CA95014 CUPERTINO, USA (US) Eugene Antony Whang, 1 Infinite Loop, MS 302-1ID, CA95014 CUPERTINO, USA (US) Rico Zorkendorfer, 1 Infinite Loop, MS 302-1ID, CA95014 CUPERTINO, USA (US) Jeremy Bataillon, 1 Infinite Loop, MS 302-1ID, CA95014 CUPERTINO, USA (US)
(30)	<b>Prioritet:</b>	2010.10.19, US, 29/377,272
(55)	<b>Designavbildninger:</b>	

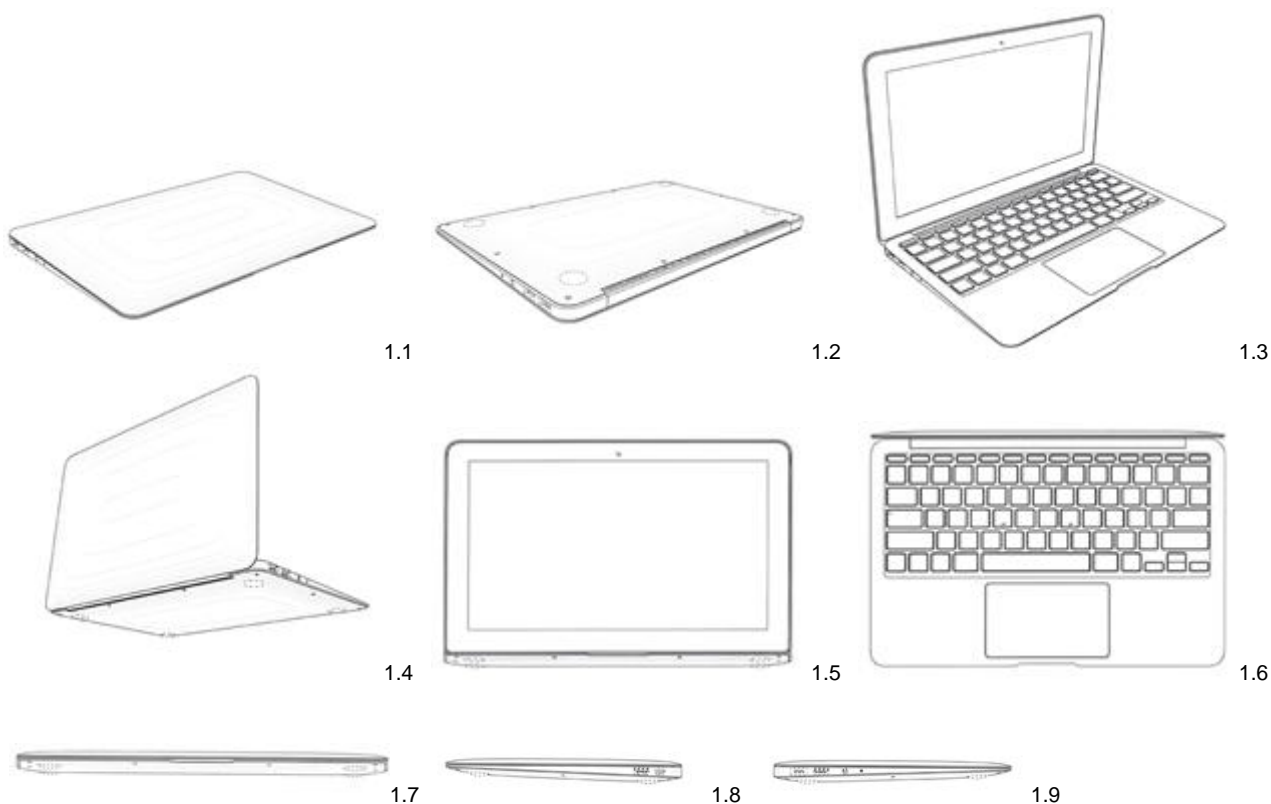





1.10



1.11



1.12



1.13



1.14



1.15

(11)	<b>Reg.nr.:</b>	<b>083165</b>
(21)	<b>Søkn.nr.:</b>	20110066
(22)	<b>Inngitt:</b>	2011.02.03
(24)	<b>Løpedag:</b>	2011.02.03
(43)	<b>Allm. tilgj.:</b>	2011.08.03
(15)	<b>Registrert:</b>	2011.09.15
(45)	<b>Kunngjort:</b>	2011.10.03
(18)	<b>Reg. gjelder til:</b>	2016.02.03
(74)	<b>Fullmektig:</b>	Onsagers AS, Postboks 6963 St Olavs Plass, 0130 OSLO
(73)	<b>Innehaver:</b>	Active Brands AS, c/o Skigutane AS, Thorvald Meyersgt 7, 0555 OSLO

**Design 1**

(54)	<b>Produkt:</b>	Kleshenger
(51)	<b>Klasse:</b>	06-08
(72)	<b>Designer:</b>	Tore Vinje Brustad, Schweigaardsgt. 54B, 0656 OSLO
(55)	<b>Designavbildninger:</b>	

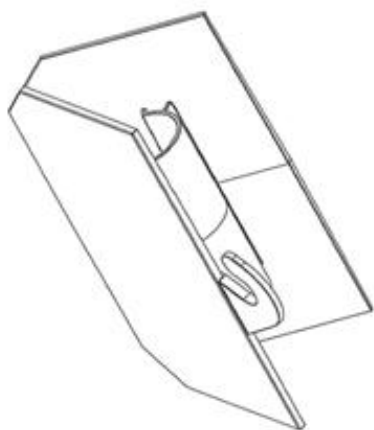

1.1



1.2

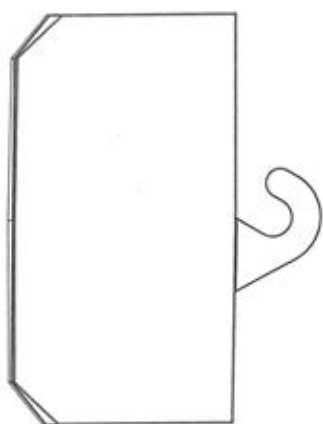

1.3

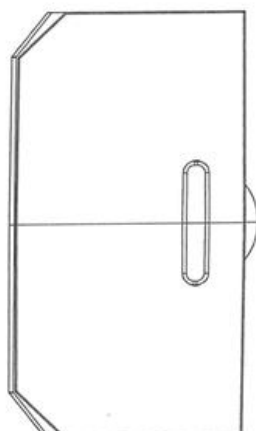

1.4

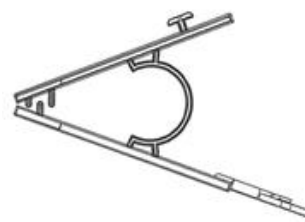

1.5

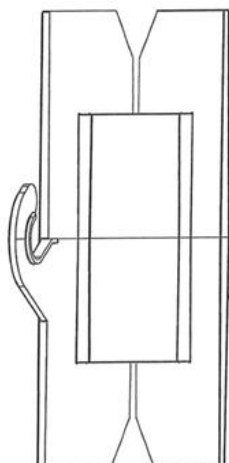

1.6

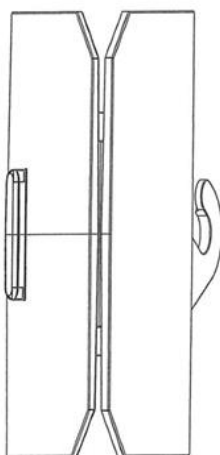

1.7

- (11) **Reg.nr.:** 083166  
(21) **Søkn.nr.:** 20100721  
(22) **Inngitt:** 2010.12.08  
(24) **Løpedag:** 2010.12.08  
(43) **Allm. tilgj.:** 2010.12.08  
(15) **Registrert:** 2011.09.15  
(45) **Kunngjort:** 2011.10.03  
(18) **Reg. gjelder til:** 2015.12.08  
(74) **Fullmektig:** Zacco Norway AS, Postboks 2003 Vika, 0125 OSLO  
(73) **Innehaver:** McNeil AB, 25109 HELSINGBORG, Sverige (SE)  
(50) **Anmerkninger:** Registreringen gjelder samregistrering.

### Design 1

- (54) **Produkt:** Beholder  
(51) **Klasse:** 09-01  
(72) **Designert:** Jonathan Paul Taylor, 71 Berkely Road, BS163NA FISHPONDS, BRISTOL, Storbritannia (GB)  
Dennis Broberg, Arvidstorpsgatan 24, 46157 TROLLHÄTTAN, Sverige (SE)  
(30) **Prioritet:** 2010.06.10, US, 29/363,488  
(55) **Designavbildninger:**

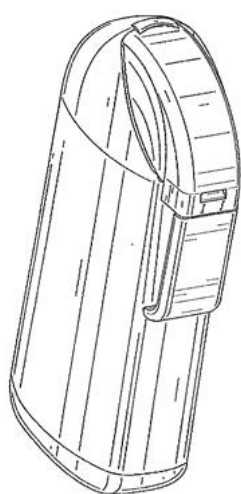

1.1

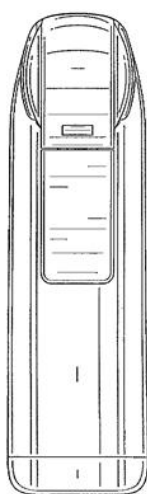

1.2

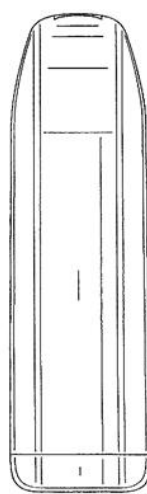

1.3

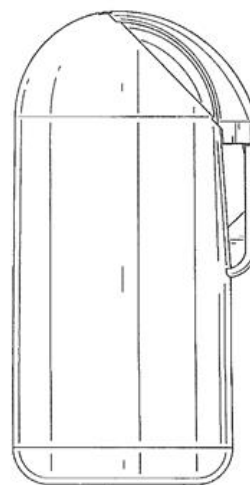

1.4

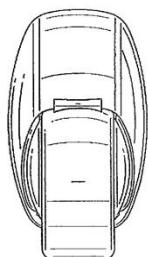

1.5



1.6

**Design 2**

- (54) **Produkt:** Del av beholder  
(51) **Klasse:** 09-01  
(72) **Designer:** Jonathan Paul Taylor, 71 Berkely Road, BS163NA FISHPONDS, BRISTOL, Storbritannia (GB)  
Dennis Broberg, Arvidstorpsгатan 24, 46157 TROLLHÄTTAN, Sverige (SE)  
(30) **Prioritet:** 2010.06.10, US, 29/363,488  
(55) **Designavbildninger:**

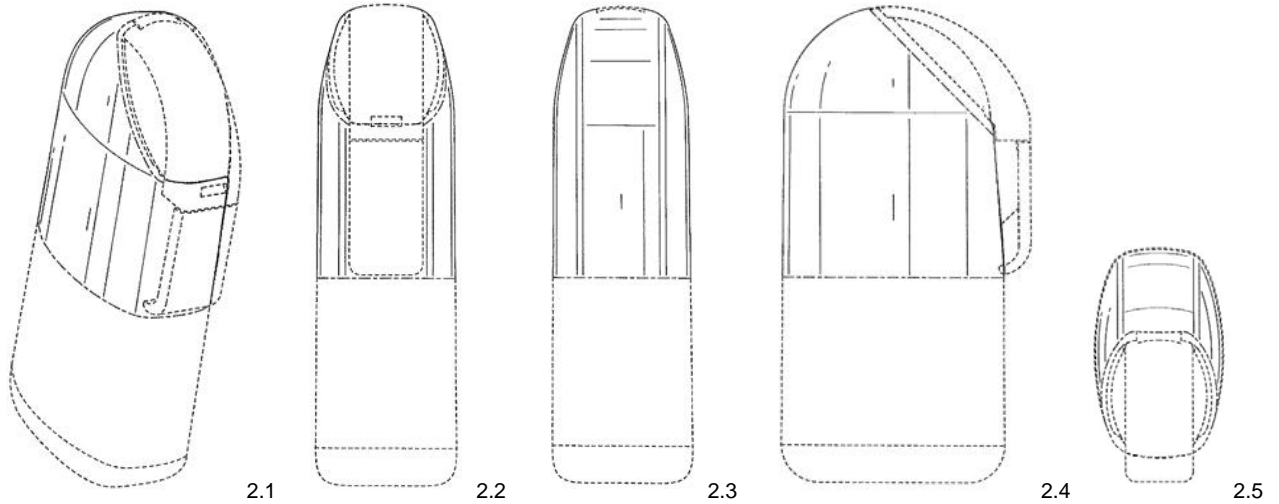
**Design 3**

- (54) **Produkt:** Del av beholder  
(51) **Klasse:** 09-01  
(72) **Designer:** Jonathan Paul Taylor, 71 Berkely Road, BS163NA FISHPONDS, BRISTOL, Storbritannia (GB)  
Dennis Broberg, Arvidstorpsгатan 24, 46157 TROLLHÄTTAN, Sverige (SE)  
(30) **Prioritet:** 2010.06.10, US, 29/363,488  
(55) **Designavbildninger:**

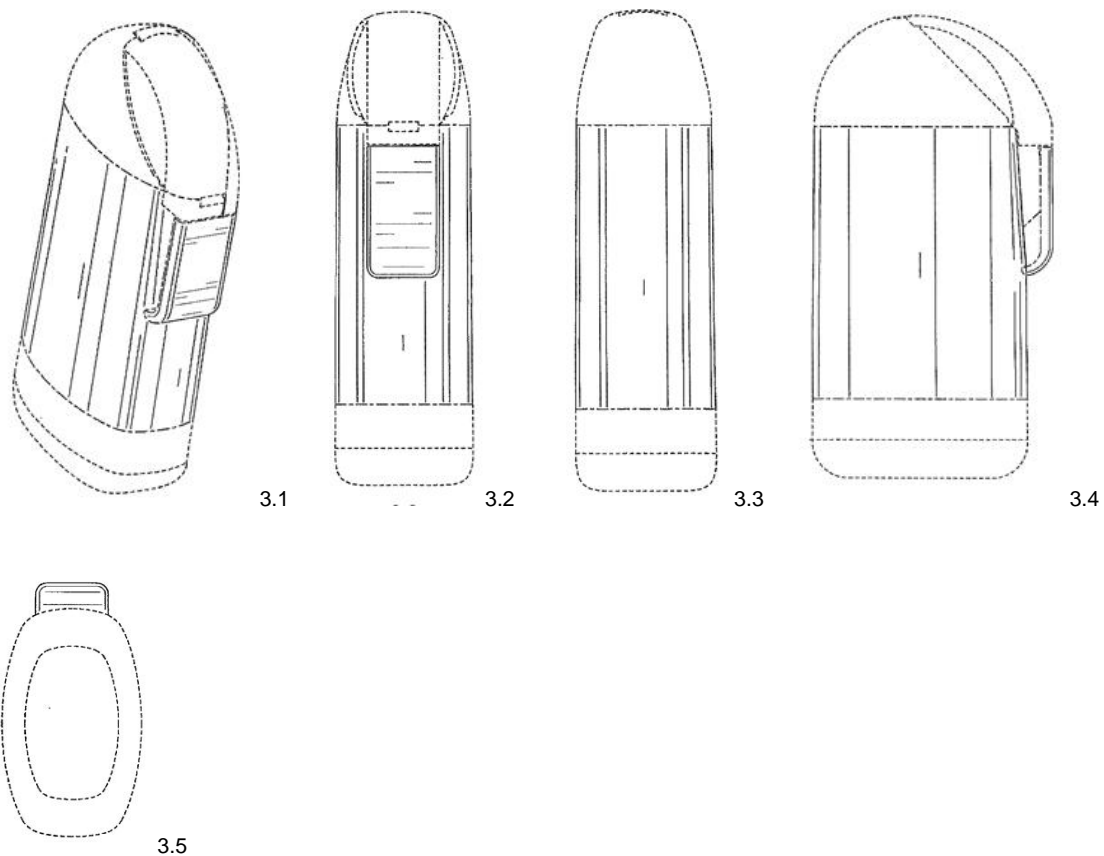

**Design 4**

- (54) **Produkt:** Del av beholder  
(51) **Klasse:** 09-01  
(72) **Designer:** Jonathan Paul Taylor, 71 Berkely Road, BS163NA FISHPONDS, BRISTOL, Storbritannia (GB)  
Dennis Broberg, Arvidstorpsgatan 24, 46157 TROLLHÄTTAN, Sverige (SE)  
(30) **Prioritet:** 2010.06.10, US, 29/363,488  
(55) **Designavbildninger:**

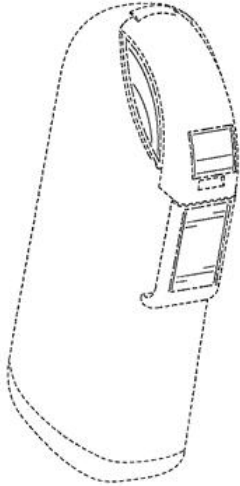

4.1

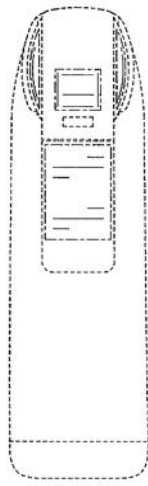

4.2

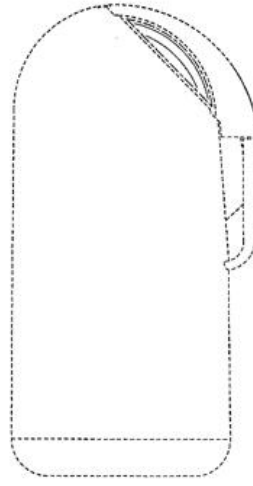

4.3

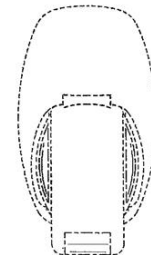

4.4

**Design 5**

- (54) **Produkt:** Del av beholder  
(51) **Klasse:** 09-01  
(72) **Designer:** Jonathan Paul Taylor, 71 Berkely Road, BS163NA FISHPONDS, BRISTOL, Storbritannia (GB)  
Dennis Broberg, Arvidstorpsgatan 24, 46157 TROLLHÄTTAN, Sverige (SE)  
(30) **Prioritet:** 2010.06.10, US, 29/363,488  
(55) **Designavbildninger:**

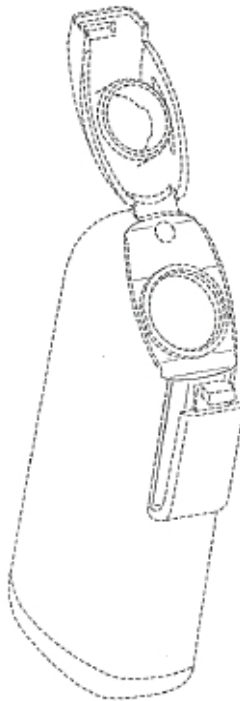

5.1

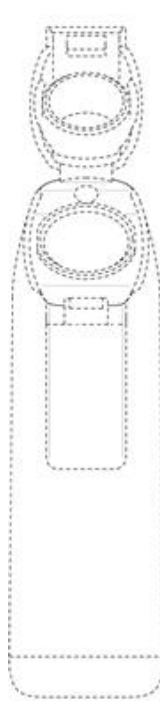

5.2

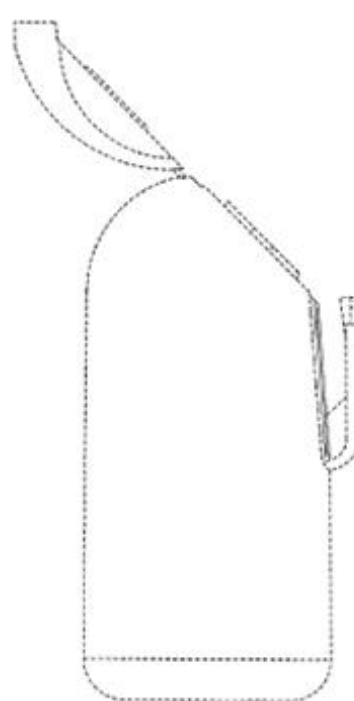

5.3

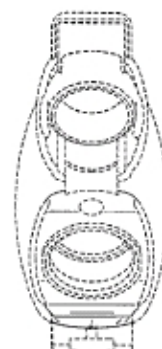

5.4

(11)	<b>Reg.nr.:</b>	<b>083167</b>
(21)	<b>Søkn.nr.:</b>	20110168
(22)	<b>Inngitt:</b>	2011.03.15
(24)	<b>Løpedag:</b>	2011.03.15
(43)	<b>Allm. tilgj.:</b>	2011.03.17
(15)	<b>Registrert:</b>	2011.09.15
(45)	<b>Kunngjort:</b>	2011.10.03
(18)	<b>Reg. gjelder til:</b>	2016.03.15
(74)	<b>Fullmektig:</b>	Protector Intellectual Property Consultants AS, Oscarsgate 20, 0352 OSLO
(73)	<b>Innehaver:</b>	Apple Inc, 1 Infinite Loop, CA95014 CUPERTINO, USA (US)
(50)	<b>Anmerkninger:</b>	Det er foretatt supplerende undersøkelse.

**Design 1**

(54)	<b>Produkt:</b>	Beskyttelsesdeksel til elektronisk anordning for databehandling
(51)	<b>Klasse:</b>	14-02
(72)	<b>Designere:</b>	Jody Akana, 1 Infinite Loop, MS 302-1ID, CA95014 CUPERTINO, USA (US) Bartley K Andre, 1 Infinite Loop, MS 302-1ID, CA95014 CUPERTINO, USA (US) Daniel J Coster, 1 Infinite Loop MS 302-1ID, CA95014 CUPERTINO, USA (US) Daniele De Iulii, 1 Infinite Loop, MS 302-1ID, CA95014 CUPERTINO, USA (US) Evans Hankey, 1 Infinite Loop, MS 302-1ID, CA95014 CUPERTINO, USA (US) Richard P Howarth, 1 Infinite Loop, MS 302-1ID, CA95014 CUPERTINO, USA (US) Jonathan P Ive, 1 Infinite Loop, MS 302-1ID, CA95014 CUPERTINO, USA (US) Duncan Robert Kerr, 1 Infinite Loop, MS 302-1ID, CA95014 CUPERTINO, USA (US) Shin Nishibori, 1 Infinite Loop, MS 302-1ID, CA95014 CUPERTINO, USA (US) Matthew Dean Rohrbach, 1 Infinite Loop, MS 302-1ID, CA95014 CUPERTINO, USA (US) Peter Russell-Clarke, 1 Infinite Loop, MS 302-1ID, CA95014 CUPERTINO, USA (US) Christopher J Stringer, 1 Infinite Loop, MS 302-1ID, CA95014 CUPERTINO, USA (US) Eugene Antony Whang, 1 Infinite Loop, MS 302-1ID, CA95014 CUPERTINO, USA (US) Rico Zorkendorfer, 1 Infinite Loop, MS 302-1ID, CA95014 CUPERTINO, USA (US) Jeremy Bataillou, 1 Infinite Loop, MS 302-1ID, CA95014 CUPERTINO, USA (US) Julian Hoenig, 1 Infinite Loop, MS 302-1ID, CA95014 CUPERTINO, USA (US)
(30)	<b>Prioritet:</b>	2010.09.17, US, 29/375,197
(50)	<b>Anmerkning:</b>	Det er foretatt supplerende undersøkelse.
(55)	<b>Designavbildninger:</b>	



1.1



1.2



1.3

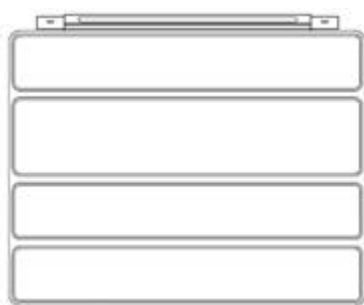

1.4



1.5

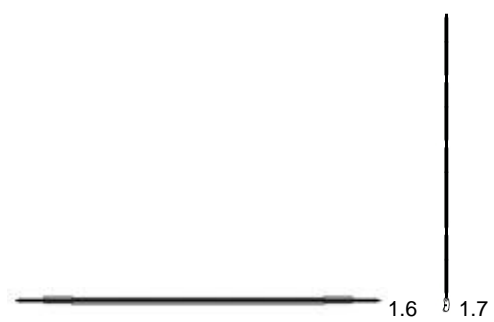

## Internasjonale designregistreringer

I henhold til designloven § 57 fjerde ledd, kunngjøres i dag følgende internasjonale registreringer som har virkning i Norge.

Det kan fremsettes krav om at designregistreringen helt eller delvis skal oppheves, jf. designloven §§ 58 fjerde ledd og 25 flg. og designforskriften §§ 26 flg.

Virkingen av en internasjonal registrering gjelder for den eller de periodene på fem år som søknaden er innlevert for, regnet fra den dagen registreringen ved det Internasjonale byrået anses å ha skjedd. Registreringen kan fornyes etter bestemmelsene i Genèveavtalen, se dl § 58 tredje ledd. Maksimal beskyttelsestid er 25 år.

(11)	<b>Reg.nr.:</b>	<b>DM/075068</b>
(21)	<b>Søkn.nr.:</b>	20110101
(22)	<b>Inngitt:</b>	2010.12.17
(24)	<b>Løpedag:</b>	2010.12.17
(43)	<b>Allm. tilgj.:</b>	2011.06.30
(15)	<b>Registrert:</b>	2010.12.17
(45)	<b>Kunngjørt:</b>	2011.10.03
(18)	<b>Reg. gjelder til:</b>	2015.12.17
(74)	<b>Fullmektig:</b>	Onsagers AS, Postboks 6963 St Olavs Plass, 0130 OSLO
(73)	<b>Innehaver:</b>	KWC AG, Hauptstrasse 57, 5726 UNTERKULM, Sveits (CH)
(50)	<b>Anmerkninger:</b>	Registreringen gjelder samregistrering.

### Design 1

(54)	<b>Produkt:</b>	Faucets
(51)	<b>Klasse:</b>	23-01
(72)	<b>Designer:</b>	Michael Lammel, Schoenrathstrasse 56, 52066 AACHEN, Tyskland (DE) Michael Zeisel, Schenkendorfstrasse 18, 52066 AACHEN, Tyskland (DE)
(55)	<b>Designavbildninger:</b>	



1.1



1.2



1.3



1.4



1.5



1.6



1.7





1.8

**Design 2**

- (54) **Produkt:** Faucets
- (51) **Klasse:** 23-01
- (72) **Designer:** Michael Lammel, Schoenrathstrasse 56, 52066 AACHEN, Tyskland (DE)  
Michael Zeisel, Schenkendorfstrasse 18, 52066 AACHEN, Tyskland (DE)
- (55) **Designavbildninger:**



2.1



2.2



2.3



2.4



2.5



2.6



2.7



2.8

**Design 3**

- (54) **Produkt:** Faucets
- (51) **Klasse:** 23-01
- (72) **Designer:** Michael Lammel, Schoenrathstrasse 56, 52066 AACHEN, Tyskland (DE)  
Michael Zeisel, Schenkendorfstrasse 18, 52066 AACHEN, Tyskland (DE)
- (55) **Designavbildninger:**



3.1



3.2



3.3



3.4



3.5



3.6



3.7



3.8

(11)	<b>Reg.nr.:</b>	<b>DM/075222</b>
(21)	<b>Søkn.nr.:</b>	20110188
(22)	<b>Inngitt:</b>	2011.02.01
(24)	<b>Løpedag:</b>	2011.02.01
(43)	<b>Allm. tilgj.:</b>	2011.08.31
(15)	<b>Registrert:</b>	2011.02.01
(45)	<b>Kunngjort:</b>	2011.08.31
(18)	<b>Reg. gjelder til:</b>	2016.02.01
(73)	<b>Innehaver:</b>	Grillwerk GmbH & Co KG , Fürstenbergerstr. 141, 60322, FRANKFURT, DE

### Design 1

(54)	<b>Produkt:</b>	Grills
(51)	<b>Klasse:</b>	07-02
(72)	<b>Designert:</b>	Bastian Goecke, Welzienstraße 24, 76135 KARLSRUHE, Tyskland (DE) Hisham Almannai, Gebhardstraße 20, 76317 KARLSRUHE, Tyskland (DE)
(50)	<b>Anmerkning:</b>	Designen er i farger.
(55)	<b>Designavbildninger:</b>	



1.1



1.2



1.3

**Design 2**

- (54) **Produkt:** Grills  
 (51) **Klasse:** 07-02  
 (72) **Designer:** Bastian Goecke, Welzienstraße 24, 76135 KARLSRUHE, Tyskland (DE)  
 Hisham Almannai, Gebhardstraße 20, 76317 KARLSRUHE, Tyskland (DE)  
 (55) **Designavbildninger:**



2.1



2.2



2.3

**Design 3**

- (54) **Produkt:** Grills  
 (51) **Klasse:** 07-02  
 (72) **Designer:** Bastian Goecke, Welzienstraße 24, 76135 KARLSRUHE, Tyskland (DE)  
 Hisham Almannai, Gebhardstraße 20, 76317 KARLSRUHE, Tyskland (DE)  
 (50) **Anmerkning:** Designen er i farger.  
 (55) **Designavbildninger:**



3.1



3.2



3.3

**Design 4**

- (54) **Produkt:** Parts of grill  
(51) **Klasse:** 07-02  
(72) **Designer:** Bastian Goecke, Welzienstraße 24, 76135 KARLSRUHE, Tyskland (DE)  
Hisham Almannai, Gebhardstraße 20, 76317 KARLSRUHE, Tyskland (DE)  
(50) **Anmerkning:** Designen er i farger.  
(55) **Designavbildninger:**



4.1

**Design 5**

- (54) **Produkt:** Parts of grill  
(51) **Klasse:** 07-02  
(72) **Designer:** Bastian Goecke, Welzienstraße 24, 76135 KARLSRUHE, Tyskland (DE)  
Hisham Almannai, Gebhardstraße 20, 76317 KARLSRUHE, Tyskland (DE)  
(50) **Anmerkning:** Designen er i farger.  
(55) **Designavbildninger:**



5.1

(11)	<b>Reg.nr.:</b>	<b>DM/075251</b>
(21)	<b>Søkn.nr.:</b>	20110194
(22)	<b>Inngitt:</b>	2011.02.15
(24)	<b>Løpedag:</b>	2011.02.15
(43)	<b>Allm. tilgj.:</b>	2011.08.31
(15)	<b>Registrert:</b>	2011.02.15
(45)	<b>Kunngjort:</b>	2011.10.03
(18)	<b>Reg. gjelder til:</b>	2016.02.15
(73)	<b>Innehaver:</b>	Ganzoni & Cie AG, Gröblistrasse 8, 9014 SANKT GALLEN, Sveits (CH)

**Design 1**

(54)	<b>Produkt:</b>	Pattern for stockings, socks and the like
(51)	<b>Klasse:</b>	32-00
(72)	<b>Designer:</b>	Jonas Thelin, 530 Wayt Road, GA30076 ROSWELL, USA (US)
(30)	<b>Prioritet:</b>	2010.08.20, US, 29/370,675
(55)	<b>Designavbildninger:</b>	

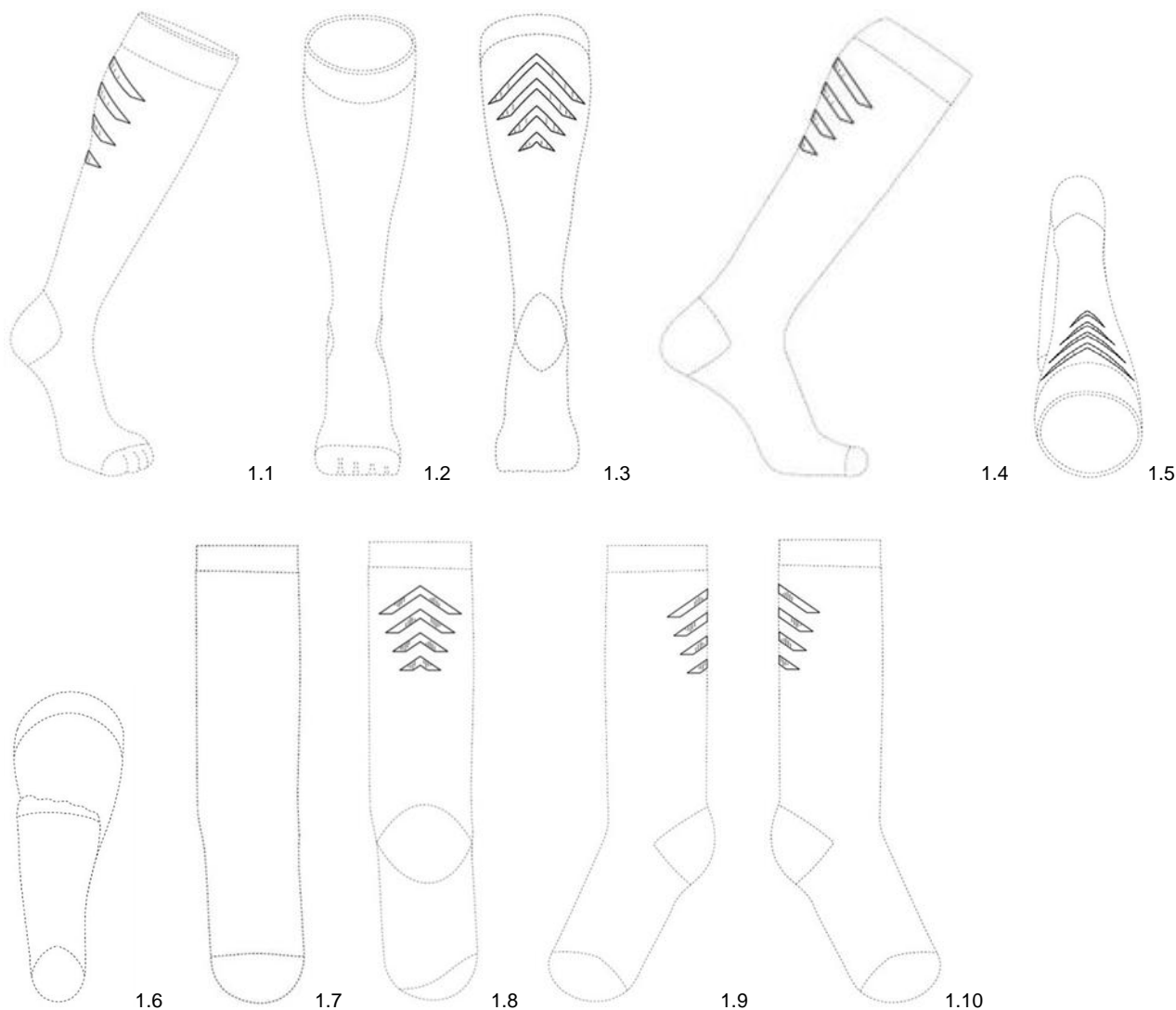

(11)	<b>Reg.nr.:</b>	<b>DM/075262</b>
(21)	<b>Søkn.nr.:</b>	20110198
(22)	<b>Inngitt:</b>	2011.02.02
(24)	<b>Løpedag:</b>	2011.02.02
(43)	<b>Allm. tilgj.:</b>	2011.08.31
(15)	<b>Registrert:</b>	2011.02.02
(45)	<b>Kunngjort:</b>	2011.10.03
(18)	<b>Reg. gjelder til:</b>	2016.02.02
(73)	<b>Innehaber:</b>	Jumbo Stillads A/S, Stålvej 9-23, 6000 KOLDING, Danmark (DK)
(50)	<b>Anmerkninger:</b>	Designene er i farger. Registreringen gjelder samregistrering.

### Design 1

(54)	<b>Produkt:</b>	Ladders
(51)	<b>Klasse:</b>	25-04
(72)	<b>Designer:</b>	Karsten Skov Hansen, Bølling Skovvej 6, 6064 JORDRUP, Danmark (DK)
(55)	<b>Designavbildninger:</b>	



### Design 2

(54)	<b>Produkt:</b>	Ladders
(51)	<b>Klasse:</b>	25-04
(72)	<b>Designer:</b>	Karsten Skov Hansen, Bølling Skovvej 6, 6064 JORDRUP, Danmark (DK)
(55)	<b>Designavbildninger:</b>	



**Design 3**

(54) **Produkt:** Ladders  
(51) **Klasse:** 25-04  
(72) **Designer:** Karsten Skov Hansen, Bølling Skovvej 6, 6064 JORDRUP, Danmark (DK)  
(55) **Designavbildninger:**



3.1



3.2



3.3

(11)	Reg.nr.:	DM/075265
(21)	Søkn.nr.:	20110199
(22)	Inngitt:	2011.02.07
(24)	Løpedag:	2011.02.07
(43)	Allm. tilgj.:	2011.08.31
(15)	Registrert:	2011.02.07
(45)	Kunngjort:	2011.10.03
(18)	Reg. gjelder til:	2016.02.07
(73)	Innehaver:	Pi-Design AG, Kantonsstrasse 100, 6234 TRIENGEN, Sveits (CH)

**Design 1**

(54)	Produkt:	Bowl
(51)	Klasse:	07-01
(72)	Designer:	Jorgen Bodum, Käppelistrasse 15, 6045 MEGGEN, Sveits (CH)
(55)	Designavbildninger:	



1.1



1.2



1.3

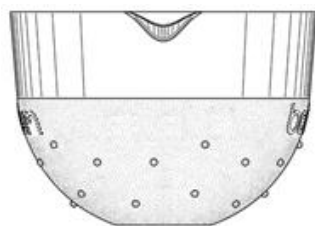

1.4

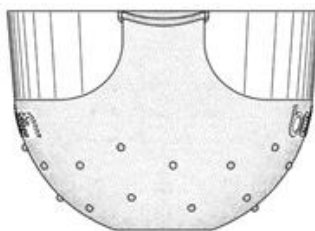

1.5

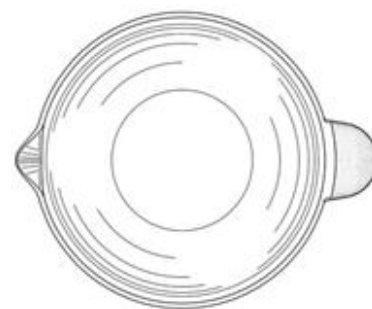

1.6

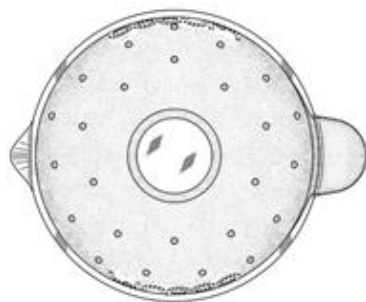

1.7

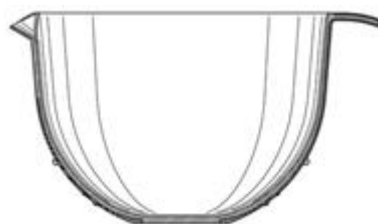

1.8



(11)	<b>Reg.nr.:</b>	<b>DM/075282</b>
(21)	<b>Søkn.nr.:</b>	20110206
(22)	<b>Inngitt:</b>	2011.01.26
(24)	<b>Løpedag:</b>	2011.02.10
(43)	<b>Allm. tilgj.:</b>	2011.08.31
(15)	<b>Registrert:</b>	2011.02.10
(45)	<b>Kunngjort:</b>	2011.10.03
(18)	<b>Reg. gjelder til:</b>	2016.02.10
(73)	<b>Innehaver:</b>	Studer & Co AG, Mööslì, 6182 ESCHOLZMATT, Sveits (CH)

**Design 1**

(54)	<b>Produkt:</b>	Bottle
(51)	<b>Klasse:</b>	09-01
(72)	<b>Designer:</b>	Katharina Friedli-Studer, Mööslì, 6182 ESCHOLZMATT, Sveits (CH)
(55)	<b>Designavbildninger:</b>	



1.1



1.2



1.3



1.4

(11)	<b>Reg.nr.:</b>	<b>DM/075284</b>
(21)	<b>Søkn.nr.:</b>	20110207
(22)	<b>Inngitt:</b>	2011.02.04
(24)	<b>Løpedag:</b>	2011.02.04
(43)	<b>Allm. tilgj.:</b>	2011.08.31
(15)	<b>Registrert:</b>	2011.02.04
(45)	<b>Kunngjort:</b>	2011.10.03
(18)	<b>Reg. gjelder til:</b>	2016.02.04
(73)	<b>Innehaver:</b>	Escofet 1886 SA, C/ Montserrat, 162, 08760 MARTORELL, BARCELONA, Spania (ES)
(50)	<b>Anmerkninger:</b>	Designen er i farger.

**Design 1**

(54)	<b>Produkt:</b>	Fountain
(51)	<b>Klasse:</b>	23-01
(72)	<b>Designer:</b>	Ferran Serre Solà, C/ Montserrat 162, 08760 MARTORELL, Spania (ES) Oscar Vera de la Rocha, C/ Montserrat 162, 08760 MARTORELL, Spania (ES)
(50)	<b>Anmerkning:</b>	Designen er i farger.
(55)	<b>Designavbildninger:</b>	

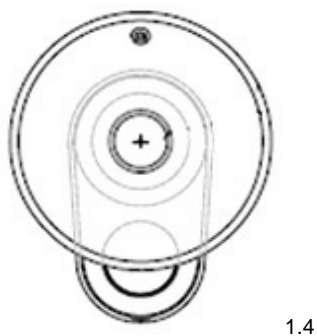
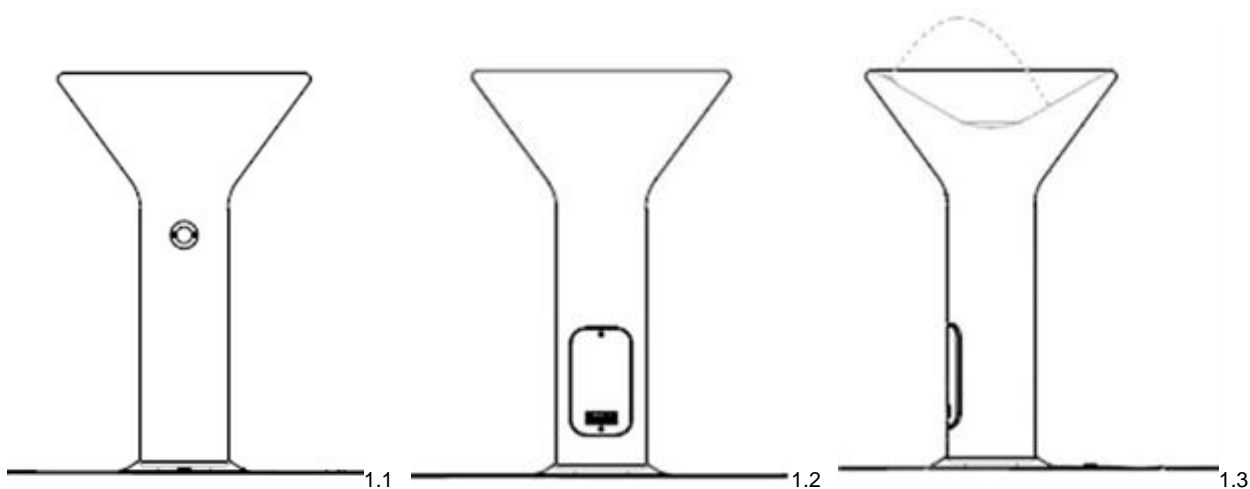

(11)	<b>Reg.nr.:</b>	<b>DM/075339</b>
(21)	<b>Søkn.nr.:</b>	20110215
(22)	<b>Inngitt:</b>	2011.02.04
(24)	<b>Løpedag:</b>	2011.02.04
(43)	<b>Allm. tilgj.:</b>	2011.08.31
(15)	<b>Registrert:</b>	2011.02.04
(45)	<b>Kunngjort:</b>	2011.10.03
(18)	<b>Reg. gjelder til:</b>	2016.02.04
(73)	<b>Innehaver:</b>	SIG Technology AG, Laufengasse 18, 8212 NEUHAUSEN AM RHEINFALL, Sveits (CH)

**Design 1**

(54)	<b>Produkt:</b>	Beverage package
(51)	<b>Klasse:</b>	09-03
(72)	<b>Designer:</b>	Ulrich Leenen, Ridderstraße 39, 41464 NEUSS, Tyskland (DE)
(30)	<b>Prioritet:</b>	2010.08.05, EM, 001740408
(55)	<b>Designavbildninger:</b>	

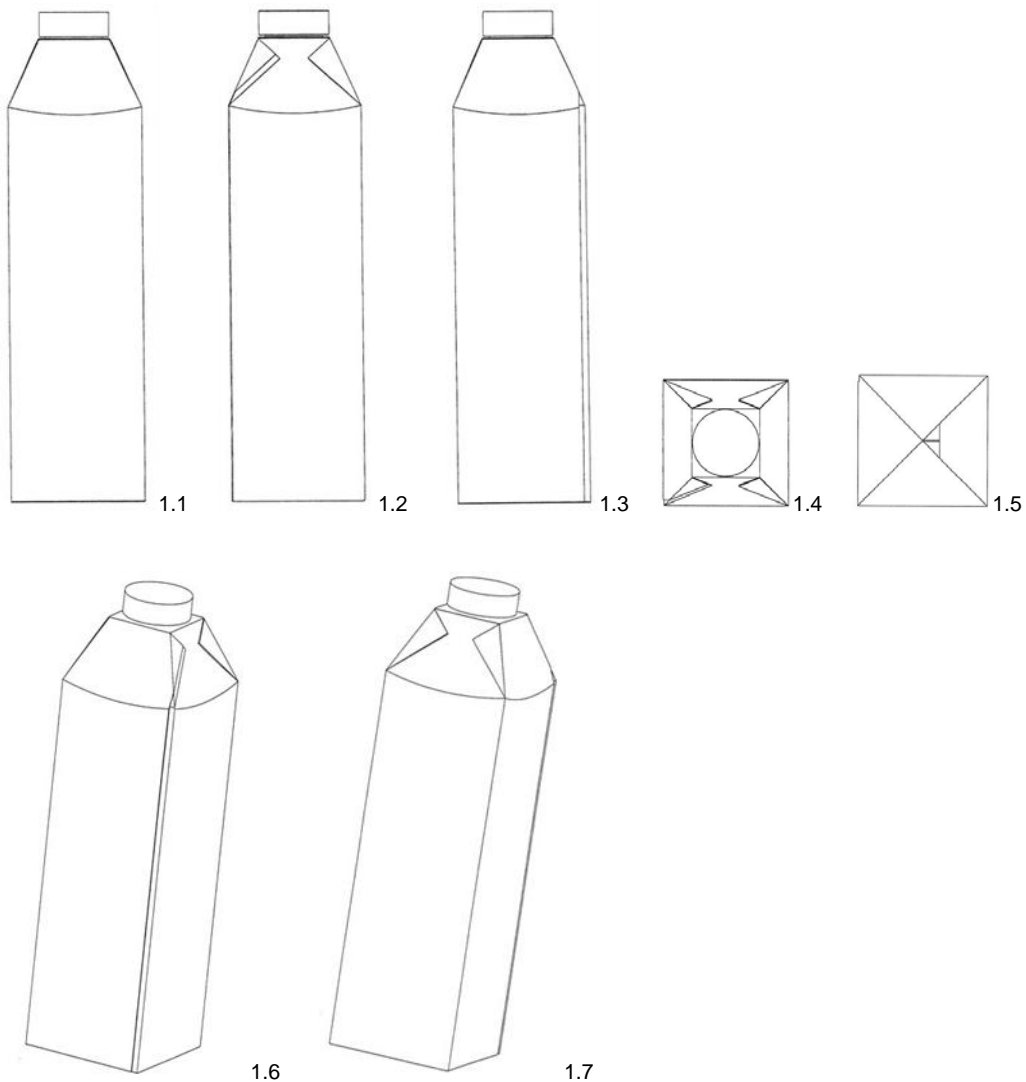

(11)	<b>Reg.nr.:</b>	<b>DM/075352</b>
(21)	<b>Søkn.nr.:</b>	20110217
(22)	<b>Inngitt:</b>	2011.02.10
(24)	<b>Løpedag:</b>	2011.02.10
(43)	<b>Allm. tilgj.:</b>	2011.08.31
(15)	<b>Registrert:</b>	2011.02.10
(45)	<b>Kunngjort:</b>	2011.10.03
(18)	<b>Reg. gjelder til:</b>	2016.02.10
(73)	<b>Innehaver:</b>	Compagnie Plastic Omnium, 19, avenue Jules Carteret, 69007 LYON, Frankrike (FR)
(50)	<b>Anmerkninger:</b>	Registreringen gjelder samregistrering.

**Design 1**

(54)	<b>Produkt:</b>	Containers for trash
(51)	<b>Klasse:</b>	09-09
(72)	<b>Designer:</b>	Fabien Delwal, 252 Allée du Château, 01320 CHALAMONT, Frankrike (FR)
(30)	<b>Prioritet:</b>	2010.09.17, EM, 001756479
(55)	<b>Designavbildninger:</b>	



1.1



1.2



1.3



1.4



1.5

**Design 2**

(54)	<b>Produkt:</b>	Containers for trash
(51)	<b>Klasse:</b>	09-09
(72)	<b>Designer:</b>	Fabien Delwal, 252 Allée du Château, 01320 CHALAMONT, Frankrike (FR)
(30)	<b>Prioritet:</b>	2010.09.17, EM, 001756479
(55)	<b>Designavbildninger:</b>	



2.1



2.2



2.3



2.4



2.5

**Design 3**

- (54) **Produkt:** Containers for trash
- (51) **Klasse:** 09-09
- (72) **Designer:** Fabien Delwal, 252 Allée du Château, 01320 CHALAMONT, Frankrike (FR)
- (30) **Prioritet:** 2010.09.17, EM, 001756479
- (55) **Designavbildninger:**



3.1



3.2



3.3



3.4



3.5

- (11) **Reg.nr.:** DM/075377  
(21) **Søkn.nr.:** 20110222  
(22) **Inngitt:** 2011.02.18  
(24) **Løpedag:** 2011.02.18  
(43) **Allm. tilgj.:** 2011.03.31  
(15) **Registrert:** 2011.02.18  
(45) **Kunngjort:** 2011.03.31  
(18) **Reg. gjelder til:** 2016.02.18  
(74) **Fullmektig:** Onsagers AS, Postboks 6963 St Olavs Plass, 0130 OSLO  
(73) **Innehaver:** Centre Vinicole Champagne Nicolas Feuillatte Union de Coopératives Agricoles, CD 40 A, Plumecoq , 51530 CHOUILLY, Frankrike (FR)  
(50) **Anmerkninger:** Design nr. 3, 4, 6 og 7 er i farger.  
Registreringen gjelder samregistrering.

### Design 1

- (54) **Produkt:** Pictographs  
(51) **Klasse:** 20-03  
(72) **Designer:** La Famille, 5 rue Vernet, 75008 PARIS, Frankrike (FR)  
(55) **Designavbildninger:**

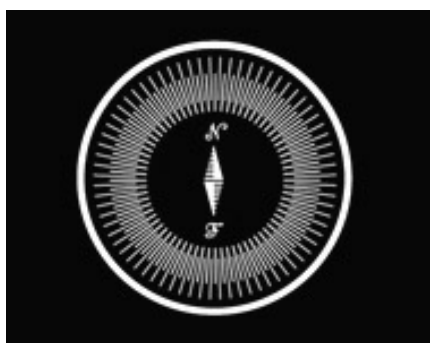

1.1

### Design 2

- (54) **Produkt:** Pictographs  
(51) **Klasse:** 20-03  
(72) **Designer:** La Famille, 5 rue Vernet, 75008 PARIS, Frankrike (FR)  
(55) **Designavbildninger:**



2.1

**Design 3**

(54)	<b>Produkt:</b>	Pictographs
(51)	<b>Klasse:</b>	20-03
(72)	<b>Designer:</b>	La Famille, 5 rue Vernet, 75008 PARIS, Frankrike (FR)
(50)	<b>Anmerkning:</b>	Designen er i farger.
(55)	<b>Designavbildninger:</b>	



3.1

**Design 4**

(54)	<b>Produkt:</b>	Pictographs
(51)	<b>Klasse:</b>	20-03
(72)	<b>Designer:</b>	La Famille, 5 rue Vernet, 75008 PARIS, Frankrike (FR)
(50)	<b>Anmerkning:</b>	Designen er i farger.
(55)	<b>Designavbildninger:</b>	



4.1

**Design 5**

(54)	<b>Produkt:</b>	Pictographs
(51)	<b>Klasse:</b>	20-03
(72)	<b>Designer:</b>	La Famille, 5 rue Vernet, 75008 PARIS, Frankrike (FR)
(55)	<b>Designavbildninger:</b>	



5.1

**Design 6**

- (54) **Produkt:** Pictographs  
(51) **Klasse:** 20-03  
(72) **Designer:** La Famille, 5 rue Vernet, 75008 PARIS, Frankrike (FR)  
(50) **Anmerkning:** Designen er i farger.  
(55) **Designavbildninger:**



6.1

**Design 7**

- (54) **Produkt:** Pictographs  
(51) **Klasse:** 20-03  
(72) **Designer:** La Famille, 5 rue Vernet, 75008 PARIS, Frankrike (FR)  
(50) **Anmerkning:** Designen er i farger.  
(55) **Designavbildninger:**



7.1



(11)	<b>Reg.nr.:</b>	<b>DM/075433</b>
(21)	<b>Søkn.nr.:</b>	20110284
(22)	<b>Inngitt:</b>	2011.01.17
(24)	<b>Løpedag:</b>	2011.01.17
(43)	<b>Allm. tilgj.:</b>	2011.04.30
(15)	<b>Registrert:</b>	2011.01.17
(45)	<b>Kunngjort:</b>	2011.04.30
(18)	<b>Reg. gjelder til:</b>	2016.01.17
(73)	<b>Innehaver:</b>	Van Genechten Packaging, Raadsherenstraat 2, 2300 TURNHOUT, Belgia (BE)

**Design 1**

(54)	<b>Produkt:</b>	Box for confectionery
(51)	<b>Klasse:</b>	09-03
(72)	<b>Designer:</b>	Frank Baeten, Waleweinlaan 132, 5665CL GELDROP, Nederland (NL)
(55)	<b>Designavbildninger:</b>	

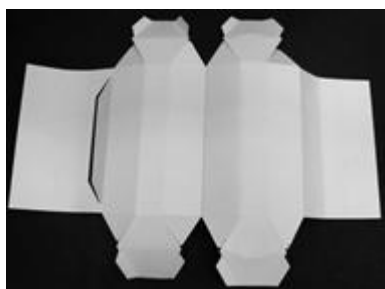

1.1



1.2



1.3



1.4

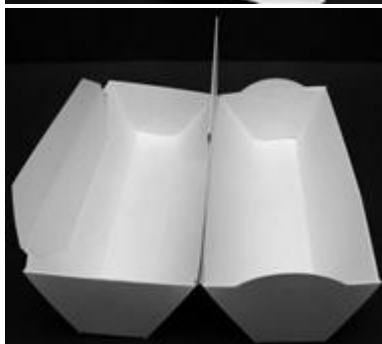

1.5



1.6



1.7



1.8

(11)	<b>Reg.nr.:</b>	<b>DM/075444</b>
(21)	<b>Søkn.nr.:</b>	20110288
(22)	<b>Inngitt:</b>	2011.02.22
(24)	<b>Løpedag:</b>	2011.02.22
(43)	<b>Allm. tilgj.:</b>	2011.04.30
(15)	<b>Registrert:</b>	2011.02.22
(45)	<b>Kunngjort:</b>	2011.04.30
(18)	<b>Reg. gjelder til:</b>	2016.02.22
(73)	<b>Innehaber:</b>	Omega SA (Omega AG) (Omega Ltd) , Jakob-Stämpfli-Strasse 96, 2502, BIEL/BIENNE, CH

**Design 1**

(54)	<b>Produkt:</b>	Clock
(51)	<b>Klasse:</b>	10-01
(72)	<b>Designer:</b>	Rik Zygmunt, Ground Floor, 84 Eccleston Square, SW1V1PX LONDON, Storbritannia (GB)
(55)	<b>Designavbildninger:</b>	

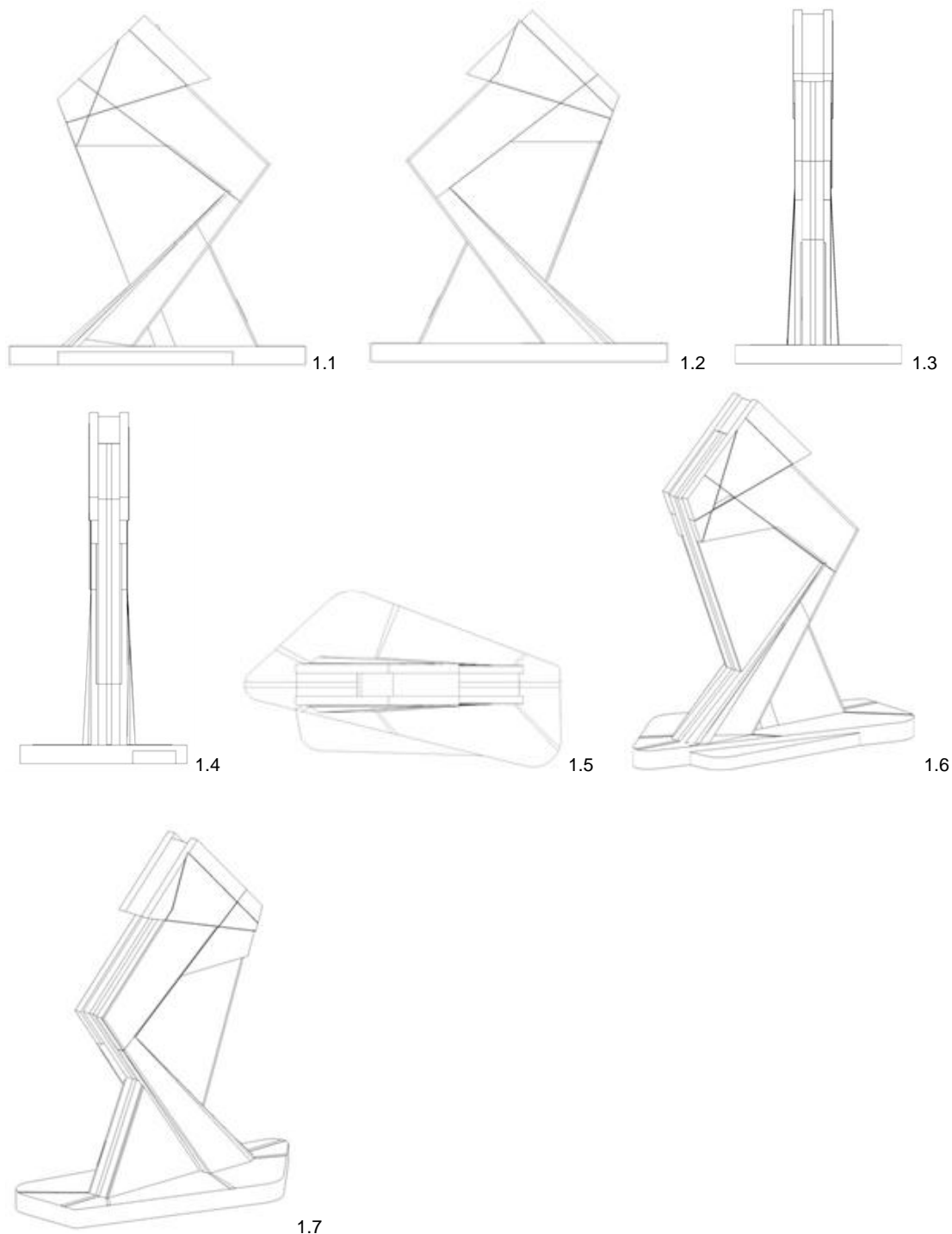

(11)	<b>Reg.nr.:</b>	<b>DM/075447</b>
(21)	<b>Søkn.nr.:</b>	20110289
(22)	<b>Inngitt:</b>	2011.02.22
(24)	<b>Løpedag:</b>	2011.02.22
(43)	<b>Allm. tilgj.:</b>	2011.04.30
(15)	<b>Registrert:</b>	2011.02.22
(45)	<b>Kunngjort:</b>	2011.04.30
(18)	<b>Reg. gjelder til:</b>	2016.02.22
(73)	<b>Innehaber:</b>	Swatch AG (Swatch SA) (Swatch Ltd) , Jakob-Stämpfli-Strasse 94, 2502, BIEL/BIENNE, CH

**Design 1**

(54)	<b>Produkt:</b>	Wristwatches
(51)	<b>Klasse:</b>	10-02
(72)	<b>Designer:</b>	Hiroyuki Matsuura, Tokyo Gallery+BTAP, 7F, 8-10-5 Ginza, Chuo-ku, 104-0061 TOKYO, Japan (JP)
(55)	<b>Designavbildninger:</b>	



1.1

**Design 2**

- (54) **Produkt:** Wristwatches  
(51) **Klasse:** 10-02  
(72) **Designer:** Hiroyuki Matsuura, Tokyo Gallery+BTAP, 7F, 8-10-5 Ginza, Chuo-ku, 104-0061 TOKYO, Japan (JP)  
(55) **Designavbildninger:**



2.1

**Design 3**

- (54) **Produkt:** Wristwatches  
(51) **Klasse:** 10-02  
(72) **Designer:** Hiroyuki Matsuura, Tokyo Gallery+BTAP, 7F, 8-10-5 Ginza, Chuo-ku, 104-0061 TOKYO, Japan (JP)  
(55) **Designavbildninger:**



3.1

**Design 4**

- (54) **Produkt:** Wristwatches  
(51) **Klasse:** 10-02  
(72) **Designer:** Hiroyuki Matsuura, Tokyo Gallery+BTAP, 7F, 8-10-5 Ginza, Chuo-ku, 104-0061 TOKYO, Japan (JP)  
(55) **Designavbildninger:**



4.1

**Design 5**

- (54) **Produkt:** Wristwatches  
(51) **Klasse:** 10-02  
(72) **Designer:** Hiroyuki Matsuura, Tokyo Gallery+BTAP, 7F, 8-10-5 Ginza, Chuo-ku, 104-0061 TOKYO, Japan (JP)  
(55) **Designavbildninger:**



5.1

**Design 6**

- (54) **Produkt:** Wristwatches  
(51) **Klasse:** 10-02  
(72) **Designer:** Hiroyuki Matsuura, Tokyo Gallery+BTAP, 7F, 8-10-5 Ginza, Chuo-ku, 104-0061 TOKYO, Japan (JP)  
(55) **Designavbildninger:**



6.1

(11)	<b>Reg.nr.:</b>	<b>DM/075453</b>
(21)	<b>Søkn.nr.:</b>	20110292
(22)	<b>Inngitt:</b>	2011.02.24
(24)	<b>Løpedag:</b>	2011.02.24
(43)	<b>Allm. tilgj.:</b>	2011.04.30
(15)	<b>Registrert:</b>	2011.02.24
(45)	<b>Kunngjort:</b>	2011.04.30
(18)	<b>Reg. gjelder til:</b>	2016.02.24
(73)	<b>Innehaber:</b>	Compagnie des Montres Longines Francillon SA , , 2610, SAINT-IMIER, CH

**Design 1**

(54)	<b>Produkt:</b>	Wristwatches
(51)	<b>Klasse:</b>	10-02
(72)	<b>Designer:</b>	Natacha Ingrosso, Chemin des Bouleaux 4, 2732 RECONVILIER, Sveits (CH)
(55)	<b>Designavbildninger:</b>	



1.1



1.2



1.3



1.4



1.5



1.6



1.7

**Design 2**

(54) **Produkt:** Wristwatches  
(51) **Klasse:** 10-02  
(72) **Designer:** Natacha Ingrosso, Chemin des Bouleaux 4, 2732 RECONVILIER, Sveits (CH)  
(55) **Designavbildninger:**



2.1



2.2



2.3



2.4



2.5



2.6



2.7



(11)	<b>Reg.nr.:</b>	<b>DM/075459</b>
(21)	<b>Søkn.nr.:</b>	20110293
(22)	<b>Inngitt:</b>	2011.02.25
(24)	<b>Løpedag:</b>	2011.02.25
(43)	<b>Allm. tilgj.:</b>	2011.04.30
(15)	<b>Registrert:</b>	2011.01.17
(45)	<b>Kunngjort:</b>	2011.10.03
(18)	<b>Reg. gjelder til:</b>	2016.01.17
(73)	<b>Innehaver:</b>	Van Genechten Packaging , Raadsherenstraat 2, 2300, TURNHOUT, BE

**Design 1**

(54)	<b>Produkt:</b>	Wristwatches
(51)	<b>Klasse:</b>	10-02
(72)	<b>Designer:</b>	Monika Jelinska, Babickiego 4/111, 94-056 LODZ, Poland (PL)
(50)	<b>Anmerkning:</b>	Designen er i farger.
(55)	<b>Designavbildninger:</b>	



1.1

**Design 2**

(54)	<b>Produkt:</b>	Wristwatches
(51)	<b>Klasse:</b>	10-02
(72)	<b>Designer:</b>	Ryan Grees, Am Weilenacker 106, 59075 HAMM, Germany (DE)
(55)	<b>Designavbildninger:</b>	



2.1

(11)	<b>Reg.nr.:</b>	<b>DM/075460</b>
(21)	<b>Søkn.nr.:</b>	20110294
(22)	<b>Inngitt:</b>	2011.02.25
(24)	<b>Løpedag:</b>	2011.02.25
(43)	<b>Allm. tilgj.:</b>	2011.04.30
(15)	<b>Registrert:</b>	2011.02.25
(45)	<b>Kunngjort:</b>	2011.04.30
(18)	<b>Reg. gjelder til:</b>	2016.02.25
(73)	<b>Innehaver:</b>	Swatch AG (Swatch SA) (Swatch Ltd) , Jakob-Stämpfli-Strasse 94, 2502, BIEL/BIENNE, CH

**Design 1**

(54)	<b>Produkt:</b>	Wristwatches
(51)	<b>Klasse:</b>	10-02
(72)	<b>Designer:</b>	Danilo Sala, Swatchlab, Via Archimede 6, 20129 MILANO, Italy (IT)
(50)	<b>Anmerkning:</b>	Designen er i farger.
(55)	<b>Designavbildninger:</b>	



1.1

**Design 2**

- (54) **Produkt:** Wristwatches  
(51) **Klasse:** 10-02  
(72) **Designer:** Danilo Sala, Swatchlab, Via Archimede 6, 20129 MILANO, Italy (IT)  
(50) **Anmerkning:** Designen er i farger.  
(55) **Designavbildninger:**



2.1

**Design 3**

- (54) **Produkt:** Wristwatches  
(51) **Klasse:** 10-02  
(72) **Designer:** Danilo Sala, Swatchlab, Via Archimede 6, 20129 MILANO, Italy (IT)  
(50) **Anmerkning:** Designen er i farger.  
(55) **Designavbildninger:**



3.1

**Design 4**

- (54) **Produkt:** Wristwatches  
(51) **Klasse:** 10-02  
(72) **Designer:** Danilo Sala, Swatchlab, Via Archimede 6, 20129 MILANO, Italy (IT)  
(50) **Anmerkning:** Designen er i farger.  
(55) **Designavbildninger:**



4.1

**Design 5**

- (54) **Produkt:** Wristwatches  
(51) **Klasse:** 10-02  
(72) **Designer:** Danilo Sala, Swatchlab, Via Archimede 6, 20129 MILANO, Italy (IT)  
(50) **Anmerkning:** Designen er i farger.  
(55) **Designavbildninger:**



5.1

(11)	<b>Reg.nr.:</b>	<b>DM/075466</b>
(21)	<b>Søkn.nr.:</b>	20110296
(22)	<b>Inngitt:</b>	2011.02.24
(24)	<b>Løpedag:</b>	2011.02.24
(43)	<b>Allm. tilgj.:</b>	2011.04.30
(15)	<b>Registrert:</b>	2011.02.24
(45)	<b>Kunngjort:</b>	2011.04.30
(18)	<b>Reg. gjelder til:</b>	2016.02.24
(73)	<b>Innehaver:</b>	Swatch AG (Swatch SA) (Swatch Ltd) , Jakob-Stämpfli-Strasse 94, 2502, BIEL/BIENNE, CH

**Design 1**

(54)	<b>Produkt:</b>	Wristwatches
(51)	<b>Klasse:</b>	10-02
(72)	<b>Designer:</b>	Rossana Boffi, Swatchlab, Via Archimede 6, 20129 MILANO, Italy (IT) Francesca Errani, Swatchlab, Via Archimede 6, 20129 MILANO, Italy (IT)
(55)	<b>Designavbildninger:</b>	



1.1

**Design 2**

- (54) **Produkt:** Wristwatches  
(51) **Klasse:** 10-02  
(72) **Designer:** Rossana Boffi, Swatchlab, Via Archimede 6, 20129 MILANO, Italy (IT)  
Francesca Errani, Swatchlab, Via Archimede 6, 20129 MILANO, Italy (IT)  
(55) **Designavbildninger:**



2.1

## Overdragelser

- (11) **Reg.nr.:** 078428, 077874, 081581,  
082953, 082954, 082955  
**Tidligere  
innehaver:** Kiwi European Holdings BV,  
Vleutensevaart 100, 3532AD  
UTRECHT, NL
- (78) **Ny  
innehaver:** S.C. Johnson & Son Inc, 1525  
Howe Street, WI53403  
RACINE, US
- 

- (11) **Reg.nr.:** 078847  
**Tidligere  
innehaver:** Tholstrup Cheese A/S,  
Skanderborgvej 277, 8260  
VIBY J, DK
- (78) **Ny  
innehaver:** Tholstrup Cheese A/S,  
Sønderhøj 14, 8260 VIBY J,  
DK
- 

- (11) **Reg.nr.:** 079528  
**Tidligere  
innehaver:** Scandi-Aqualine A/S,  
Postboks 19, 6800 VARDE,  
DK
- (78) **Ny  
innehaver:** Ifö Sanitär AB, Box 140, 29522  
BROMÖLLA, SE
- 

- (11) **Reg.nr.:** 079877  
**Tidligere  
innehaver:** HSE Norway AS, Postboks  
2000, C/o VIS, 5409 STORD,  
NO
- (78) **Ny  
innehaver:** HSE Norway AS, Hamnegata  
22, 5411 STORD, NO
- 

- (11) **Reg.nr.:** 080374  
**Tidligere  
innehaver:** Jan H Øien, N. Dagali 18,  
1621 GRESSVIK, NO
- (78) **Ny  
innehaver:** Erik Solbakke, Enghaugen 14,  
1621 GRESSVIK, NO
- 

- (11) **Reg.nr.:** 082520  
**Tidligere  
innehaver:** Buttress BV, Vleutensevaart  
100, 3532AD UTRECHT, NL
- (78) **Ny  
innehaver:** S C Johnson & Son Inc, 1525  
Howe Street, WI53403  
RACINE, US
-



## Endringer i fullmaktsforhold

(11) **Reg.nr.:** 077322  
(21) **Søknadsnr.:** 20010614  
(73) **Innehaver:** Stokke AS, Håhjem, 6260  
SKODJE, NO  
(74) **Fullmektig:** Zacco Norway AS,  
Postboks 2003 Vika,  
0125 OSLO, NO

---

(11) **Reg.nr.:** 077776, 077621, 077622,  
078622, 079242, 079144,  
079445, 079611, 079446,  
079447, 079849, 070611,  
080012, 071091, 073683,  
076343, 077251, 077556,  
080183, 080244, 080286,  
080696, 080567, 080886,  
080950, 081006, 081013,  
081188, 081315, 081895,  
082088, 082485, 082488,  
082884, 083041  
(21) **Søknadsnr.:** 20030393, 20030395,  
20030396, 20040241,  
20040554, 20050171,  
20050521, 20050522,  
20050523, 20050555,  
20050561, 19920155,  
20060472, 19920812,  
19960922, 20000485,  
20010719, 20020522,  
20060532, 20060671,  
20060716, 20070120,  
20070306, 20070500,  
20070694, 20070731,  
20070743, 20080128,  
20080259, 20080643,  
20090483, 20100085,  
20100087, 20100497,  
20110063  
(73) **Innehaver:** Bang & Olufsen A/S,  
Postboks 40, 7600  
STRUER, DK  
(74) **Fullmektig:** Advokatfirmaet  
Thommessen AS,  
Postboks 1484 Vika,  
0116 OSLO, NO

---

(11) **Reg.nr.:** 076056, 081941, 081995  
(21) **Søknadsnr.:** 20000152, 20090132,  
20090279  
(73) **Innehaver:** AB Wibe, Box 401, 79227  
MORA, SE  
(74) **Fullmektig:** Onsagers AS, Postboks  
6963 St Olavs Plass,  
0130 OSLO, NO

---

(11) **Reg.nr.:** 076996, 080187  
(21) **Søknadsnr.:** 20010579, 20060555  
(73) **Innehaver:** Ergonomiprodukter i  
Bodafors AB, Box 294,  
57123 NÄSSJÖ, SE  
(74) **Fullmektig:** Awapatent AB, Box 5117,  
20071 MALMÖ, SE

---

## Fornyelse av registreringer

(11) **Reg.nr:** 073690 **Fornyhet til:** 2016.09.24  
(73) **Innehaver:** Theben AG, Hohenbergstrasse 32, 72401, HAIGERLOCH, DE  
(74) **Fullmektig:** Curo AS, Industriveien 53, 7080, HEIMDAL, NO

---

(11) **Reg.nr:** 073756 **Fornyhet til:** 2016.11.11  
(73) **Innehaver:** Gipeco AB, Kabelvägen 8, 55302, JÖNKÖPING, SE  
(74) **Fullmektig:** Zacco Norway AS, Postboks 2003 Vika, 0125, OSLO, NO

---

(11) **Reg.nr:** 073854 **Fornyhet til:** 2016.11.20  
(73) **Innehaver:** Tone Grimsrud, Færgestadveien 18, 3475, SÆTRE, NO  
(74) **Fullmektig:** Oslo Patentkontor AS, Postboks 7007 Majorstua, 0306, OSLO, NO

---

(11) **Reg.nr:** 076663 **Fornyhet til:** 2016.09.20  
(73) **Innehaver:** Grammer AG, Wernher-von-Braun-Strasse 6, 92225, AMBERG, DE  
(74) **Fullmektig:** Zacco Norway AS, Postboks 2003 Vika, 0125, OSLO, NO

---

(11) **Reg.nr:** 076947 **Fornyhet til:** 2016.09.14  
(73) **Innehaver:** Elas AS, Melkeveien 2, 7650, VERDAL, NO  
(74) **Fullmektig:** Curo AS, Industriveien 53, 7080, HEIMDAL, NO

---

(11) **Reg.nr:** 077105 **Fornyhet til:** 2016.10.15  
(73) **Innehaver:** Sabo AS, Postboks 4448, 7418, TRONDHEIM, NO  
(74) **Fullmektig:** Curo AS, Industriveien 53, 7080, HEIMDAL, NO

---

(11) **Reg.nr:** 077322 **Fornyhet til:** 2016.10.22  
(73) **Innehaver:** Stokke AS, Håhjem, 6260, SKODJE, NO  
(74) **Fullmektig:** Zacco Norway AS, Postboks 2003 Vika, 0125, OSLO, NO

---

(11) **Reg.nr:** 077324 **Fornyhet til:** 2017.02.22  
(73) **Innehaver:** Draka Norsk Kabel AS, Postboks 369 Bragernes, 3001, DRAMMEN, NO  
(74) **Fullmektig:** Zacco Norway AS, Postboks 2003 Vika, 0125, OSLO, NO

---

(11) **Reg.nr:** 077609 **Fornyhet til:** 2016.09.24  
(73) **Innehaver:** Fuchs Petrolub AG, Friesenheimer Strasse 1, 68169, MANNHEIM, DE  
(74) **Fullmektig:** Acapo AS, Postboks 1880 Nordnes, 5817, BERGEN, NO

---

(11) **Reg.nr:** 077611 **Fornyhet til:** 2016.09.24  
(73) **Innehaver:** Fuchs Petrolub AG, Friesenheimer Strasse 1, 68169, MANNHEIM, DE  
(74) **Fullmektig:** Acapo AS, Postboks 1880 Nordnes, 5817, BERGEN, NO

---

(11) **Reg.nr:** 080017 **Fornyhet til:** 2016.09.20  
(73) **Innehaver:** Erik Fladmark, Postboks 73, 6001, ÅLESUND, NO  
(74) **Fullmektig:** Curo AS, Industriveien 53, 7080, HEIMDAL, NO

---

(11) **Reg.nr:** 080018 **Fornyhet til:** 2016.09.08  
(73) **Innehaver:** Thorn Europhane, 156 Boulevard Haussmann, 75008, PARIS, FR  
(74) **Fullmektig:** Zacco Norway AS, Postboks 2003 Vika, 0125, OSLO, NO

---

(11) **Reg.nr:** 080063 **Fornyhet til:** 2016.09.07  
(73) **Innehaver:** Hriszto Atanaszov Dacsev, Telepes u 64/A, 1147, BUDAPEST, HU  
(74) **Fullmektig:** Zacco Norway AS, Postboks 2003 Vika, 0125, OSLO, NO

---

(11) **Reg.nr:** 080070 **Fornyhet til:** 2016.10.11  
(73) **Innehaver:** Skjæveland Cementstøperi AS, Fabrikkveien 164, 4323, SANDNES, NO  
(74) **Fullmektig:** Håmsø Patentbyrå ANS, Postboks 171, 4302, SANDNES, NO

---

(11) **Reg.nr:** 080089 **Fornyhet til:** 2016.10.20  
(73) **Innehaver:** Exentri AS, Vogsgate 60A, 0477, OSLO, NO  
(74) **Fullmektig:** Onsagers AS, Postboks 6963 St Olavs Plass, 0130, OSLO, NO

---

(11) **Reg.nr:** 080104 **Fornyhet til:** 2016.05.22  
(73) **Innehaver:** Vestkorn AS, Kvernveien 62, 4120, TAU, NO

---

(11) **Reg.nr:** 080106 **Fornyhet til:** 2016.08.21  
(73) **Innehaver:** Svale DA, Vereide, 6823, SANDANE, NO

---

(11) **Reg.nr:** 080117 **Fornyhet til:** 2016.10.24  
(73) **Innehaver:** Ferrari SpA, Via Emilia Est, 1163, 41100, MODENA, IT  
(74) **Fullmektig:** Oslo Patentkontor AS, Postboks 7007 Majorstua, 0306, OSLO, NO

---

(11) **Reg.nr:** 080118 **Fornyhet til:** 2016.10.24  
(73) **Innehaver:** Ferrari SpA, Via Emilia Est, 1163, 41100, MODENA, IT  
(74) **Fullmektig:** Oslo Patentkontor AS, Postboks 7007 Majorstua, 0306, OSLO, NO

---

(11) **Reg.nr:** 080210 **Fornyhet til:** 2016.10.20  
(73) **Innehaver:** Vectura Delivery Devices Ltd, 1 Prospect West, SN146FH, CHIPPENHAM, WILTSHIRE, GB  
(74) **Fullmektig:** Onsagers AS, Postboks 6963 St Olavs Plass, 0130, OSLO, NO

---

(11) **Reg.nr:** 080282 **Fornyhet til:** 2016.09.22  
(73) **Innehaver:** Sildnes Stenprodukter, 6490, EIDE, NO  
(74) **Fullmektig:** Trygve Eide, Storgata 21, 6509, KRISTIANSUND N, NO

---

(11) **Reg.nr:** 080305 **Fornyhet til:** 2016.10.27  
(73) **Innehaver:** Sinituote OY, Erkyän kartano 50, 05820, HYVINGE, FI  
(74) **Fullmektig:** Oslo Patentkontor AS, Postboks 7007 Majorstua, 0306, OSLO, NO

---

(11) **Reg.nr:** 080312 **Fornyhet til:** 2016.11.02  
(73) **Innehaver:** Gripple Ltd, The Old West Gun Works, Savile Street East, S47UQ, SHEFFIELD, GB  
(74) **Fullmektig:** Zacco Norway AS, Postboks 2003 Vika, 0125, OSLO, NO

---

(11) **Reg.nr:** 080320 **Fornyhet til:** 2016.09.07  
(73) **Innehaver:** Spilka International AS, Langrabben 71, Emblem, 6013, ÅLESUND, NO  
(74) **Fullmektig:** Acapo AS, Postboks 1880 Nordnes, 5817, BERGEN, NO

---