

Norsk

# design tidende

[www.patentstyret.no](http://www.patentstyret.no)

Norsk designtidende er en publikasjon som inneholder kunngjøringer innenfor designområdet

**BESØKSADRESSE**

- ▶ Sandakerveien 64

**POSTADRESSE**

- ▶ Postboks 8160 Dep.  
0033 Oslo

**E-POST**

- ▶ [mail@patentstyret.no](mailto:mail@patentstyret.no)

**TELEFON**

- ▶ 22 38 73 00

**TELEFAKS**

- ▶ 22 38 73 01

**INFOSENTERETS TELEFONTID**

- ▶ kl. 09.00 - 15.00  
Telefon (+47) 22 38 73 33  
Telefaks (+47) 22 38 73 31

## Innholdsfortegnelse:

Registrerte design .....	3
Internasjonale designregistreringer .....	43
Fornyelse av registreringer .....	69

### INID-koder

I kunngjøringene er de enkelte data forsynt med koder overensstemmende med INID-kodesystemet (INID= Internationally agreed Numbers for the Identification of Data).

- (11) Registreringsnummer
- (15) Registreringsdato
- (18) Dato som registreringen gjelder til
- (21) Søknadsnummer
- (22) Inngivelsesdato
- (24) Løpedag
- (30) Prioritetsopplysninger
- (43) Allment tilgjengelig dato
- (51) Klasse
- (54) Produkt
- (55) Avbildning(er)
- (72) Designer
- (73) Innehaver
- (74) Fullmektig

## Registrerte design

I henhold til designloven § 18 første ledd i.f. kunngjøres i dag følgende registrerte design.

Det kan fremsettes krav om at designregistreringen helt eller delvis skal oppheves, jf. designloven §§ 25 flg. og designforskriften §§ 26 flg.

Designregistreringen gjelder for den eller de periodene på fem år som søknaden er innlevert for, regnet fra søknadsdagen. Registreringen kan fornyes, jf. designloven §§ 23 og 24. Maksimal beskyttelsestid er 25 år. For reservedeler, se unntaket i designloven § 23 annet ledd.

- (11) **Reg.nr.:** 082773
- (21) **Søkn.nr.:** 20100468
- (22) **Inngitt:** 2010.09.21
- (24) **Løpedag:** 2010.09.21
- (43) **Allm. tilgj.:** 2011.01.21
- (15) **Registrert:** 2011.01.21
- (45) **Kunngjort:** 2011.02.21
- (18) **Reg. gjelder til:** 2015.09.21
- (55) **Avbildning(er):**

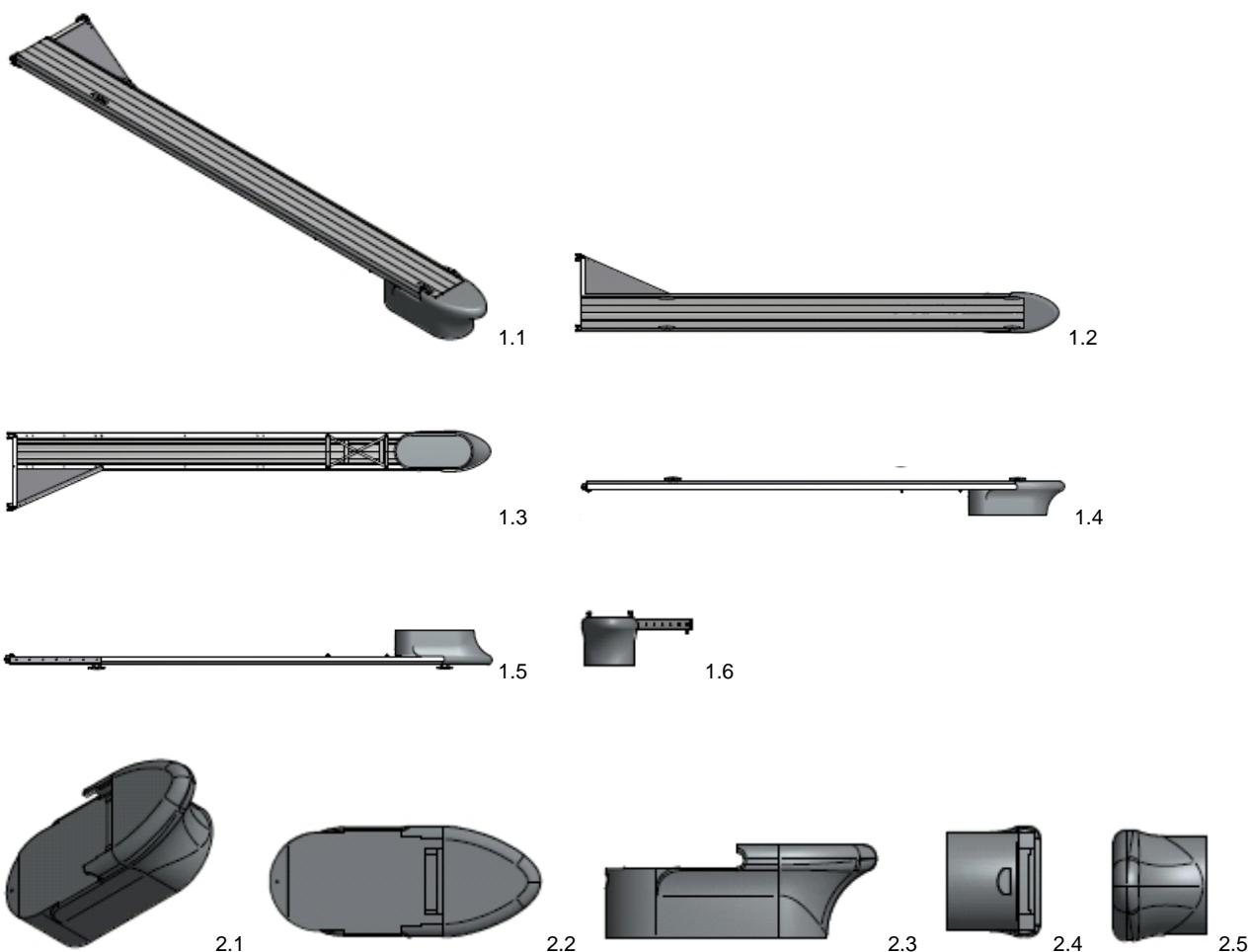

- (74) **Fullmektig:** Curo AS, Industriveien 53, 7080 HEIMDAL, NO
- (54) **Produkt:** 1. Utrigger  
2. Flottør til uttrigger
- (51) **Klasse:** 1-2. 25-03
- (73) **Innehaver:** Ørsta Marina Systems AS, Strandgata 59, 6150 ØRSTA, NO
- (72) **Designer:** Roy Lennart Almestad, Eineveien 7, 6150 ØRSTA, NO
- (60) **Anmerkning:** Registreringen gjelder samregistrering.

- (11) Reg.nr.: 082774
- (21) Søkn.nr.: 20100355
- (22) Inngitt: 2010.07.13
- (24) Løpedag: 2010.07.13
- (43) Allm. tilgj.: 2010.07.13
- (15) Registrert: 2011.01.24
- (45) Kunngjort: 2011.02.21
- (18) Reg. gjelder til: 2015.07.13
- (55) Avbildning(er):

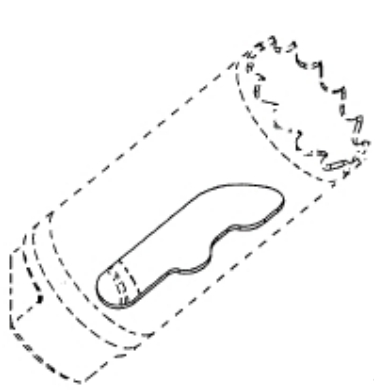

1.1

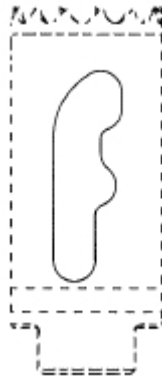

1.2



1.3

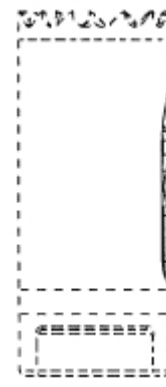

1.4



1.5



1.6



1.7

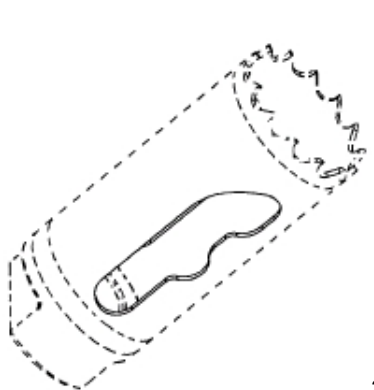

2.1

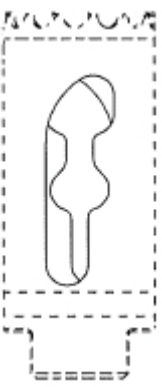

2.2



2.3



2.4



2.5

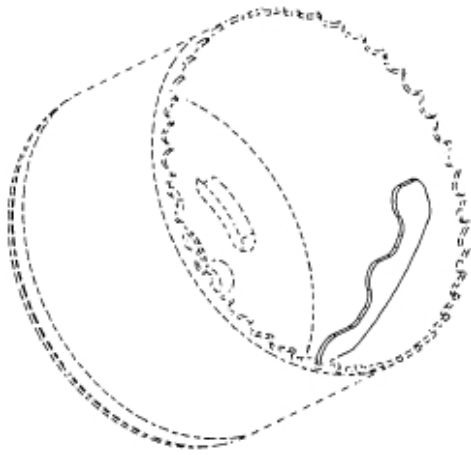

3.1

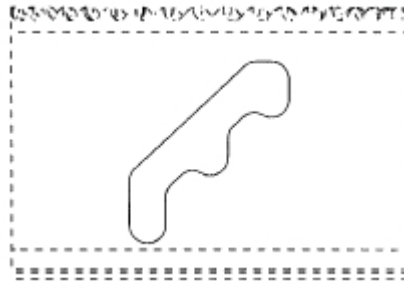

3.2

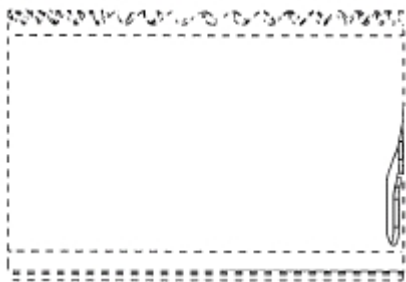

3.3



3.4



3.5

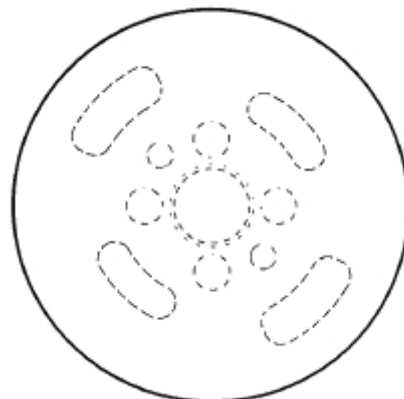

3.6

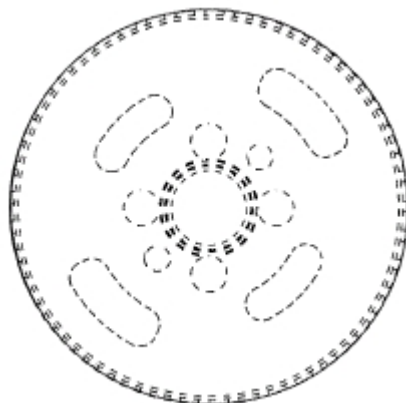

3.7

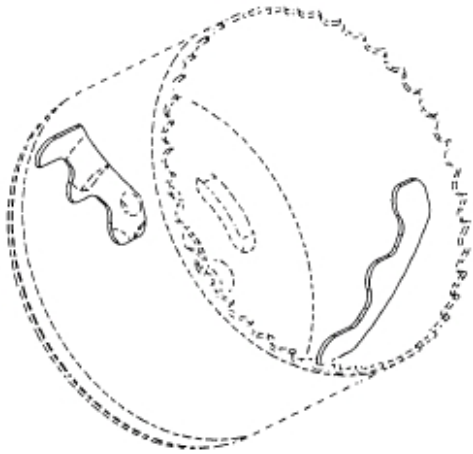

4.1

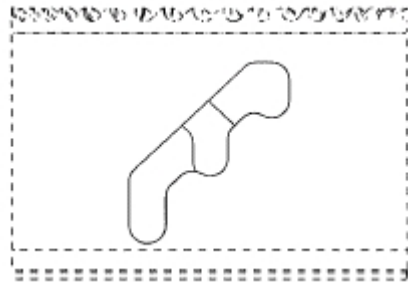

4.2

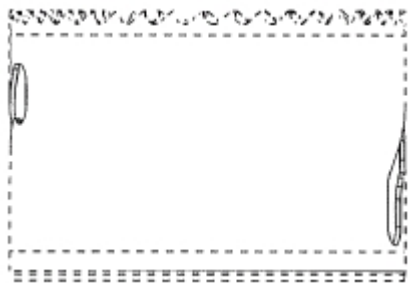

4.3

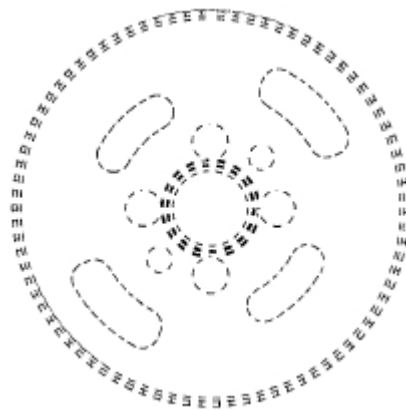

4.4

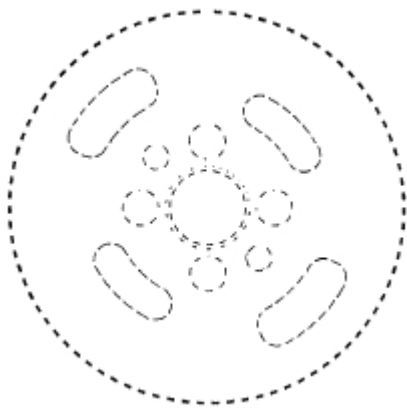

4.5

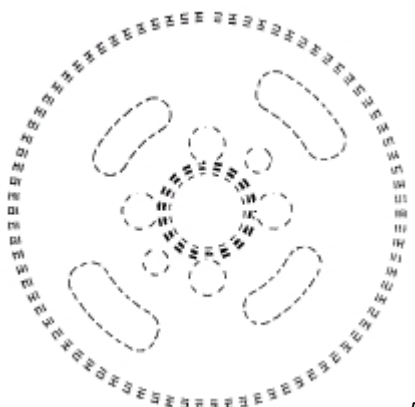

5.1

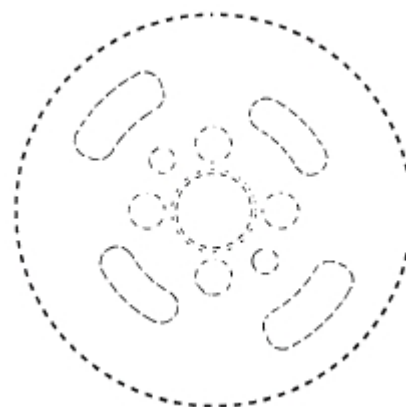

5.2

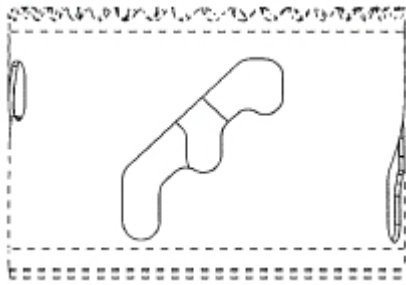

5.3

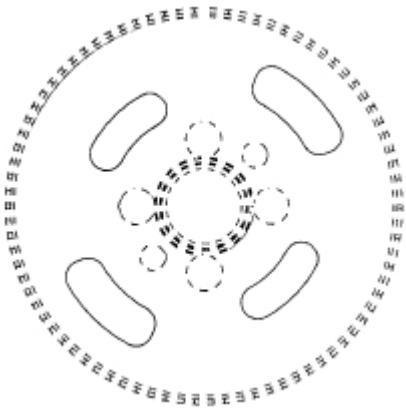

6.1

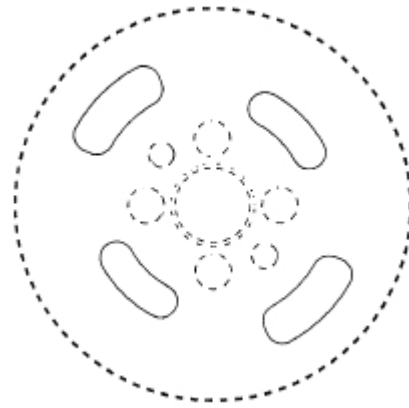

6.2

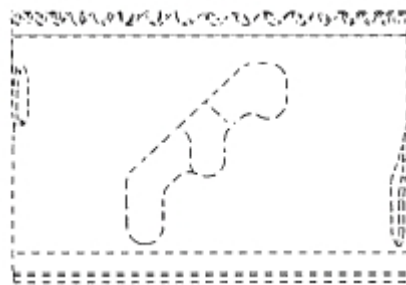

6.3

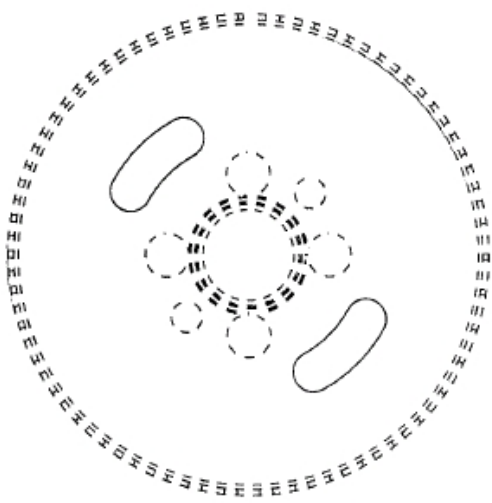

7.1

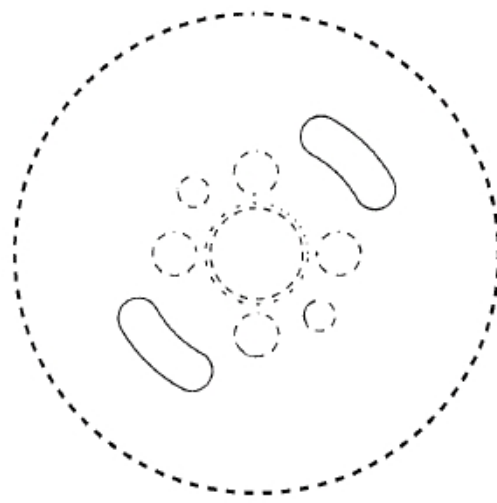

7.2

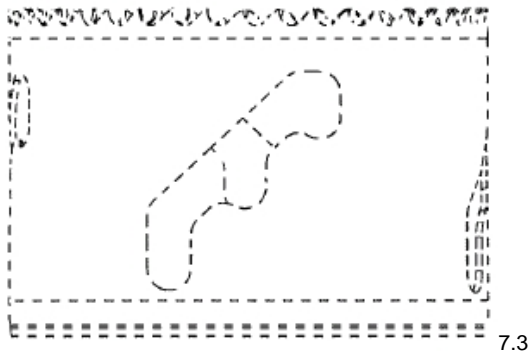

- (74) **Fullmektig:** Bryn Aarflot AS, Postboks 449 Sentrum, 0104 OSLO, NO  
(54) **Produkt:** 1-7. Del av hullsag  
(51) **Klasse:** 1-7. 08-03  
(73) **Innehaver:** Irwin Industrial Tool Co, 8935 NorthPointe Executive Drive, NC28078 HUNTERSVILLE, US  
(72) **Designer:** Joseph Thomas Novak, 32 Abbey Lane, MA01028 EAST LONGMEADOW, US  
Matthew Christopher Green, 680 Station Road, MA01002 AMHERST, US  
Robert Richard Zielonka, 327 Brainard Road Unit 108, CT06082 ENFIELD, US  
William B Korb, 151 Melrose Road, CT06016 BROAD BROOK, US  
(30) **Prioritet:** 2010.01.13 US 29/353,759  
(60) **Anmerkning:** Registreringen gjelder samregistrering.  
Det er foretatt supplerende undersøkelse.
-



- (11) **Reg.nr.:** 082775  
(21) **Søkn.nr.:** 20100507  
(22) **Inngitt:** 2010.10.08  
(24) **Løpedag:** 2010.10.08  
(43) **Allm. tilgj.:** 2011.01.24  
(15) **Registrert:** 2011.01.24  
(45) **Kunngjort:** 2011.02.21  
(18) **Reg. gjelder til:** 2015.10.08  
(55) **Avbildning(er):**

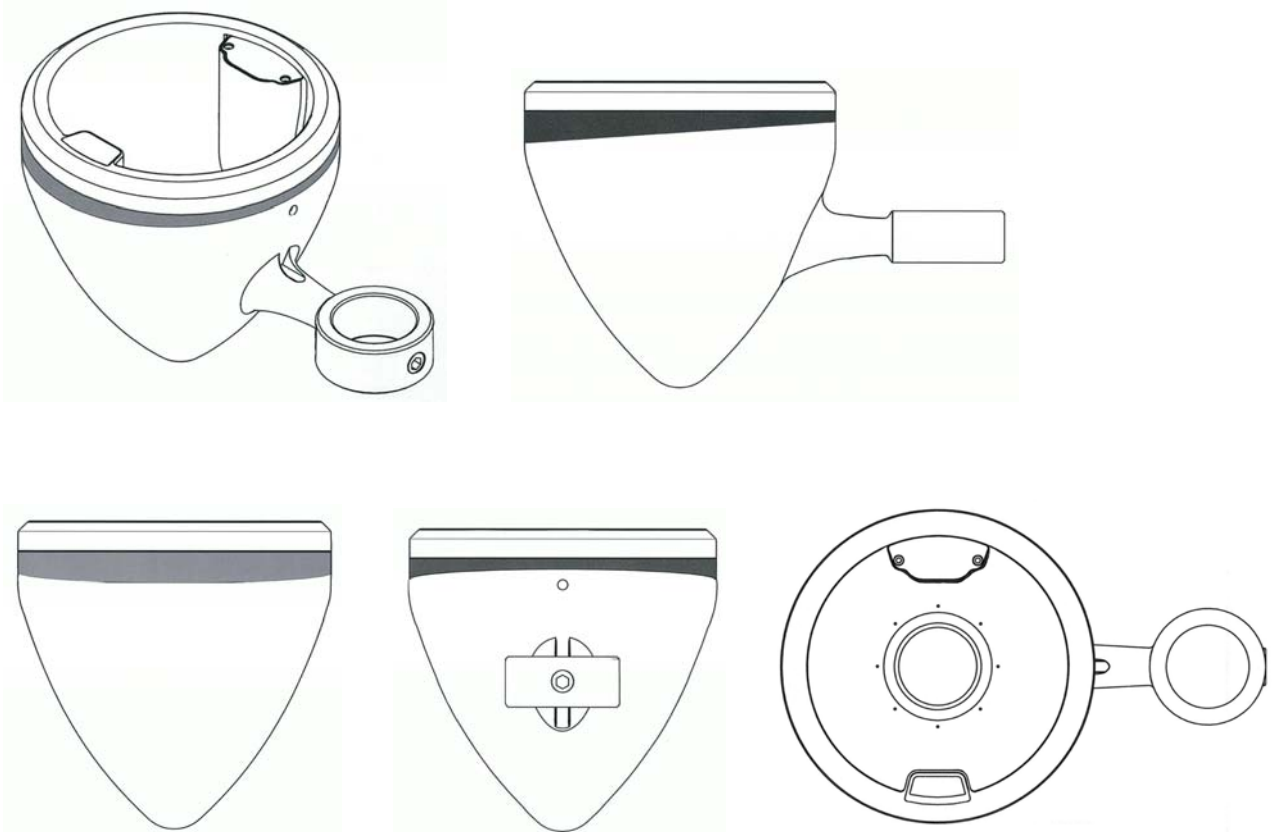

- (74) **Fullmektig:** Onsagers AS, Postboks 6963 St Olavs Plass, 0130 OSLO, NO  
(54) **Produkt:** Blomsterpotte for montering på stativ/stolpe  
(51) **Klasse:** 11-02  
(73) **Innehaver:** Clara Eline Platou Faraasen, Karisvingen 11, 2050 JESSHEIM, NO  
(72) **Designer:** Clara Eline Platou Faraasen, Karisvingen 11, 2050 JESSHEIM, NO

- (11) **Reg.nr.:** 082776  
(21) **Søkn.nr.:** 20100448  
(22) **Inngitt:** 2010.09.06  
(24) **Løpedag:** 2010.09.06  
(43) **Allm. tilgj.:** 2010.09.06  
(15) **Registrert:** 2011.01.24  
(45) **Kunngjort:** 2011.02.21  
(18) **Reg. gjelder til:** 2015.09.06  
(55) **Avbildning(er):**



1.1



1.2



1.3

Detaljutsnitt



1.4

Detaljutsnitt



1.5

Detaljutsnitt



1.6

Detaljutsnitt



2.1



3.1



3.2



3.3

- (54) **Produkt:** 1. Skjorte til festdrakt  
2. Forkle til festdrakt  
3. Lue til festdrakt
- (51) **Klasse:** 1-3. 02-02
- (73) **Innehaver:** BUNADSEKSPERTEN NUF, Engelstadvegen 8 B, 2840 REINSVOLL, NO
- (72) **Designer:** Karin-Cecilie Skumlien Dalseth, Engelstadvegen 8b, 2840 REINSVOLL, NO
- (60) **Anmerking:** Registreringen gjelder samregistrering.

- (11) **Reg.nr.:** 082777
- (21) **Søkn.nr.:** 20100512
- (22) **Inngitt:** 2010.10.11
- (24) **Løpedag:** 2010.10.11
- (43) **Allm. tilgj.:** 2011.01.24
- (15) **Registrert:** 2011.01.24
- (45) **Kunngjort:** 2011.02.21
- (18) **Reg. gjelder til:** 2015.10.11
- (55) **Avbildning(er):**

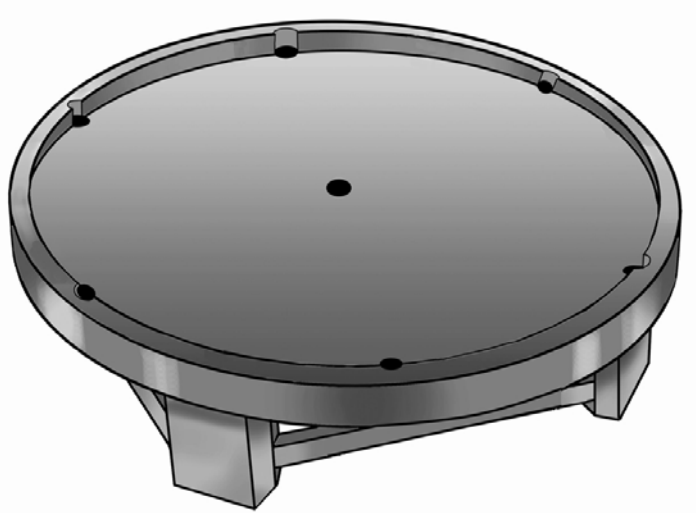

- (54) **Produkt:** Biljardbord
  - (51) **Klasse:** 06-03
  - (73) **Innehaver:** KJELL OLAV NILSEN, Postboks 1213, 9262 TROMSØ, NO
  - (72) **Designer:** Kjell-Olav Nilsen, Postboks 1213, 9262 TROMSØ, NO
-

- (11) **Reg.nr.:** 082778  
(21) **Søkn.nr.:** 20100410  
(22) **Inngitt:** 2010.08.11  
(24) **Løpedag:** 2010.08.11  
(43) **Allm. tilgj.:** 2010.08.25  
(15) **Registrert:** 2011.01.25  
(45) **Kunngjort:** 2011.02.21  
(18) **Reg. gjelder til:** 2015.08.11  
(55) **Avbildning(er):**

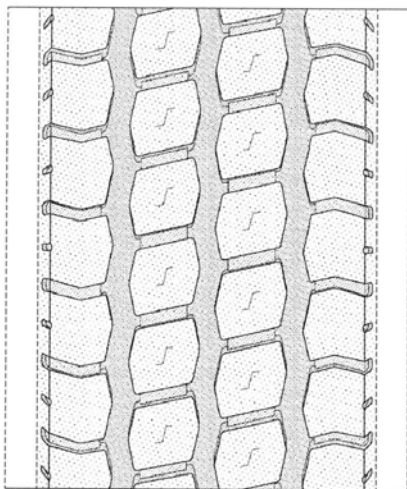
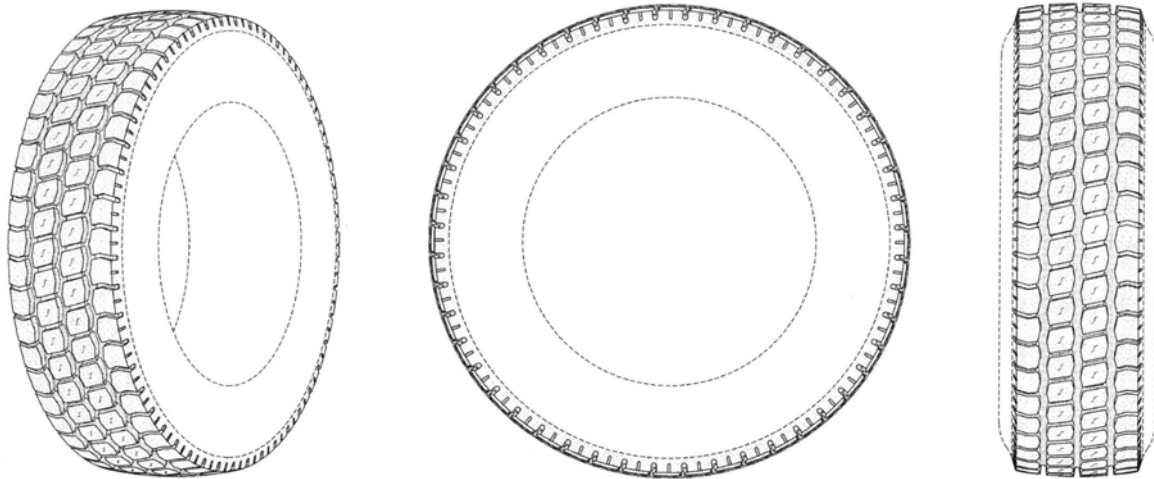

Detaljutsnitt

- (74) **Fullmektig:** Tandbergs Patentkontor AS, Postboks 1570 Vika, 0118 OSLO, NO  
(54) **Produkt:** Del av dekk  
(51) **Klasse:** 12-15  
(73) **Innehaver:** The Goodyear Tire & Rubber Co, 1144 East Market Street, OH44316-0001 AKRON, US  
(72) **Designer:** Jean-Francois Cazin-Bourguignon, 14, Rue Robert Kruger, 57390 AUDUN-LE-TICHE, FR  
Jean-Michel Alphonse Fernand Gillard, Via Sesmara 4, bte 33, 6700 ARLON, BE  
(30) **Prioritet:** 2010.02.25 US 29/356,409

- (11) Reg.nr.: 082779  
(21) Søkn.nr.: 20100477  
(22) Inngitt: 2010.09.27  
(24) Løpedag: 2010.09.27  
(43) Allm. tilgj.: 2010.10.26  
(15) Registrert: 2011.01.26  
(45) Kunngjort: 2011.02.21  
(18) Reg. gjelder til: 2015.09.27  
(55) Avbildning(er):

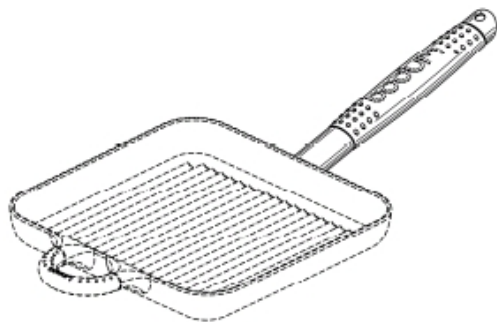

1.1

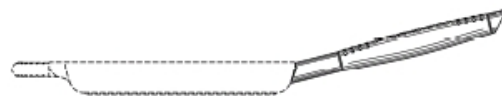

1.2

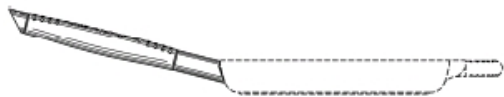

1.3

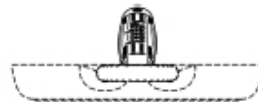

1.4

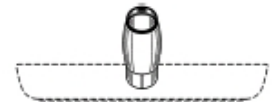

1.5

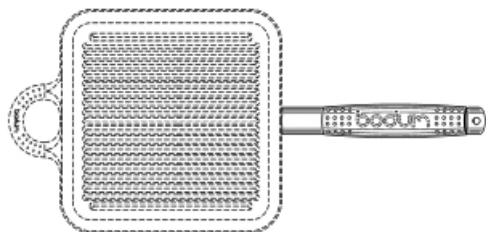

1.6

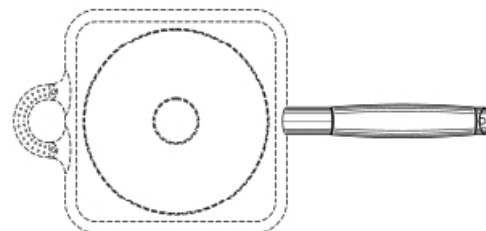

1.7

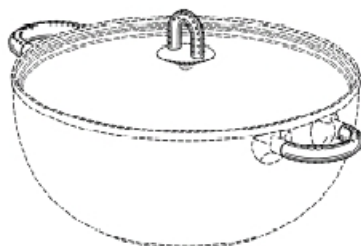

2.1

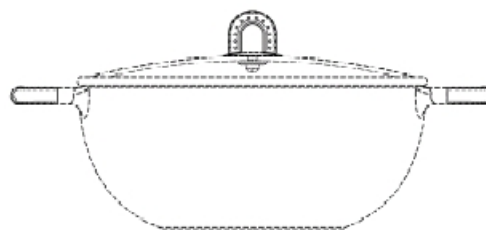

2.2

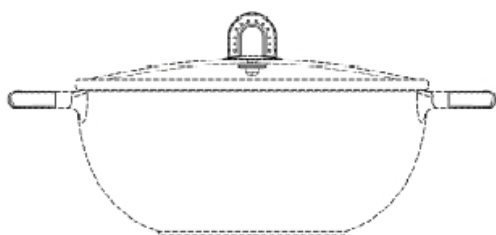

2.3

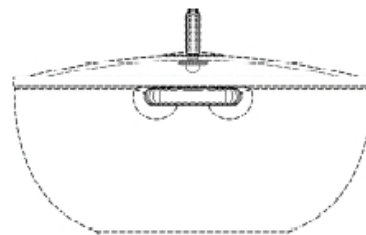

2.4

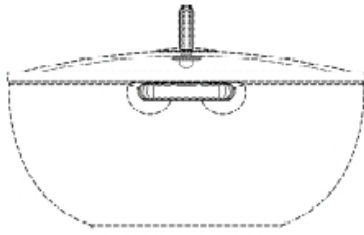

2.5

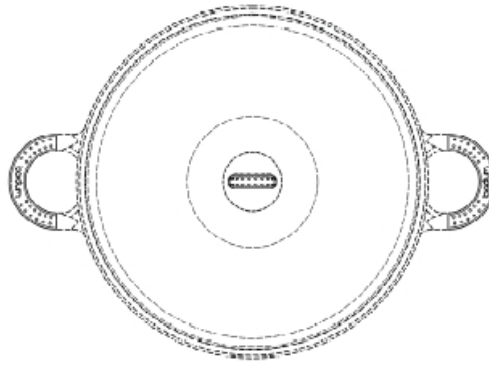

2.6

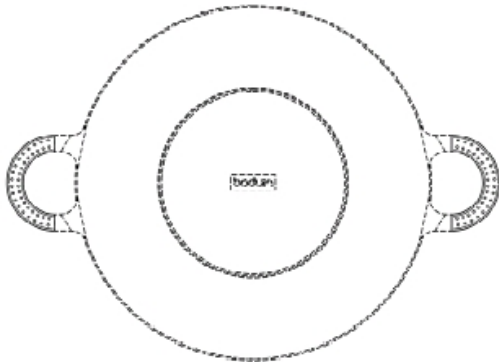

2.7

- (74) **Fullmektig:** Håmsø Patentbyrå ANS, Postboks 171, 4302 SANDNES, NO  
(54) **Produkt:** 1. Håndtak til panne/kasserolle  
2. Håndtak til kokekar  
(51) **Klasse:** 1-2. 07-02  
(73) **Innehaver:** Pi-Design AG, Kantonsstrasse 100, 6234 TRIENGEN, CH  
(72) **Designer:** Jørgen Bodum, Käppelistrasse 15, 6045 MEGGEN, CH  
(30) **Prioritet:** 2010.04.26 WO DM/073 505  
(60) **Anmerking:** Registreringen gjelder samregistrering.

- (11) Reg.nr.: 082780  
(21) Søkn.nr.: 20100438  
(22) Inngitt: 2010.09.01  
(24) Løpedag: 2010.09.01  
(43) Allm. tilgj.: 2010.10.30  
(15) Registrert: 2011.01.26  
(45) Kunngjort: 2011.02.21  
(18) Reg. gjelder til: 2015.09.01  
(55) Avbildning(er):

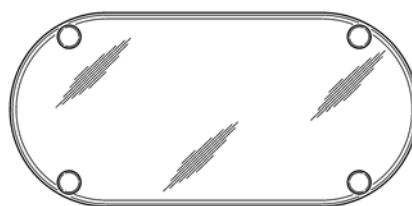
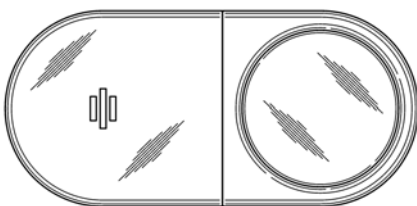
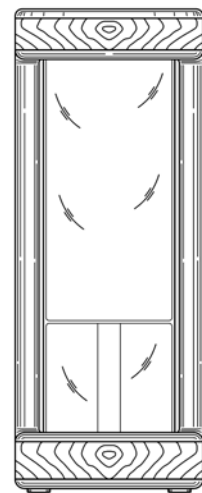
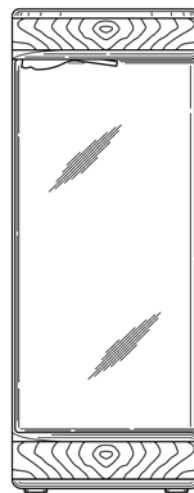
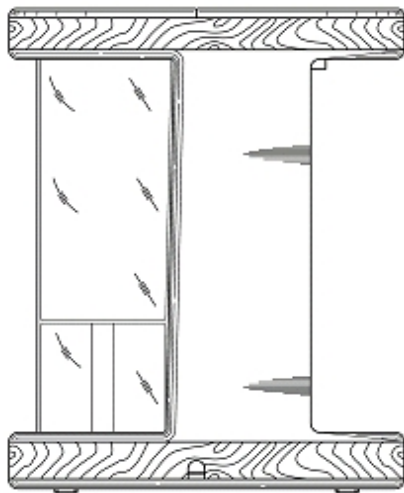
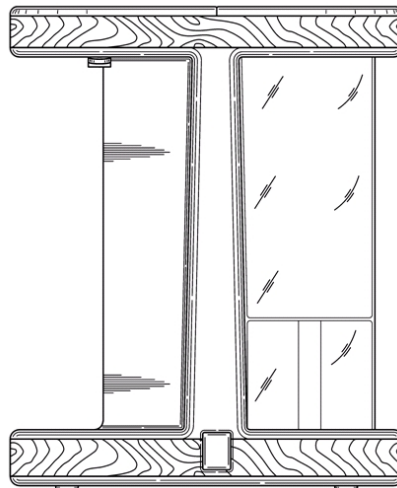
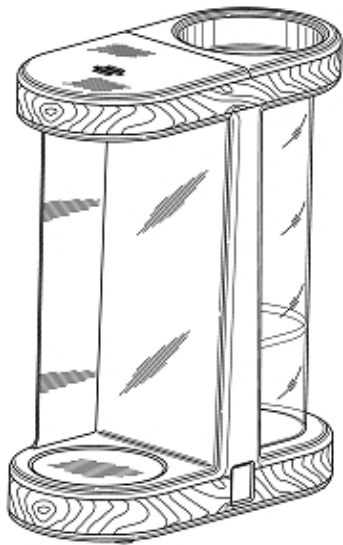



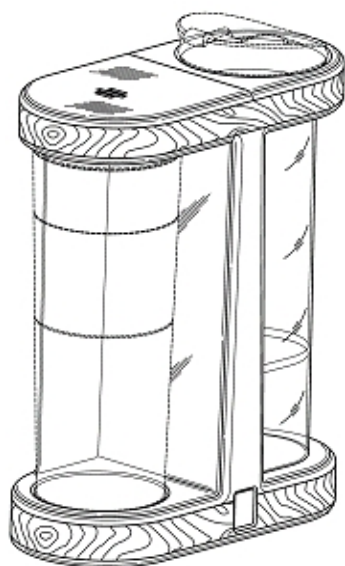

- (74) **Fullmektig:** Håmsø Patentbyrå ANS, Postboks 171, 4302 SANDNES, NO  
(54) **Produkt:** Kaffetrakter  
(51) **Klasse:** 07-02  
(73) **Innehaver:** Pi-Design AG, Kantonsstrasse 100, 6234 TRIENGEN, CH  
(72) **Designer:** Jørgen Bodum, Käppelistrasse 15, 6045 MEGGEN, CH  
(30) **Prioritet:** 2010.04.30 WO DM/073 550
-

(11) **Reg.nr.:** 082781  
(21) **Søkn.nr.:** 20100431  
(22) **Inngitt:** 2010.08.24  
(24) **Løpedag:** 2010.08.24  
(43) **Allm. tilgj.:** 2011.01.26  
(15) **Registrert:** 2011.01.26  
(45) **Kunngjort:** 2011.02.21  
(18) **Reg. gjelder til:** 2015.08.24  
(55) **Avbildning(er):**



(54) **Produkt:** Del av strenginstrument  
(51) **Klasse:** 17-03  
(73) **Innehaver:** Frode Grostøl, Kobbervn 12, 4616 KRISTIANSAND, NO  
(72) **Designer:** Frode Grostøl, Kobbervn 12, 4616 KRISTIANSAND, NO  
(60) **Anmerkning:** Designen er i farger.

---

- (11) **Reg.nr.:** 082782  
(21) **Søkn.nr.:** 20100526  
(22) **Inngitt:** 2010.10.21  
(24) **Løpedag:** 2010.10.21  
(43) **Allm. tilgj.:** 2011.01.27  
(15) **Registrert:** 2011.01.27  
(45) **Kunngjort:** 2011.02.21  
(18) **Reg. gjelder til:** 2015.10.21  
(55) **Avbildning(er):**

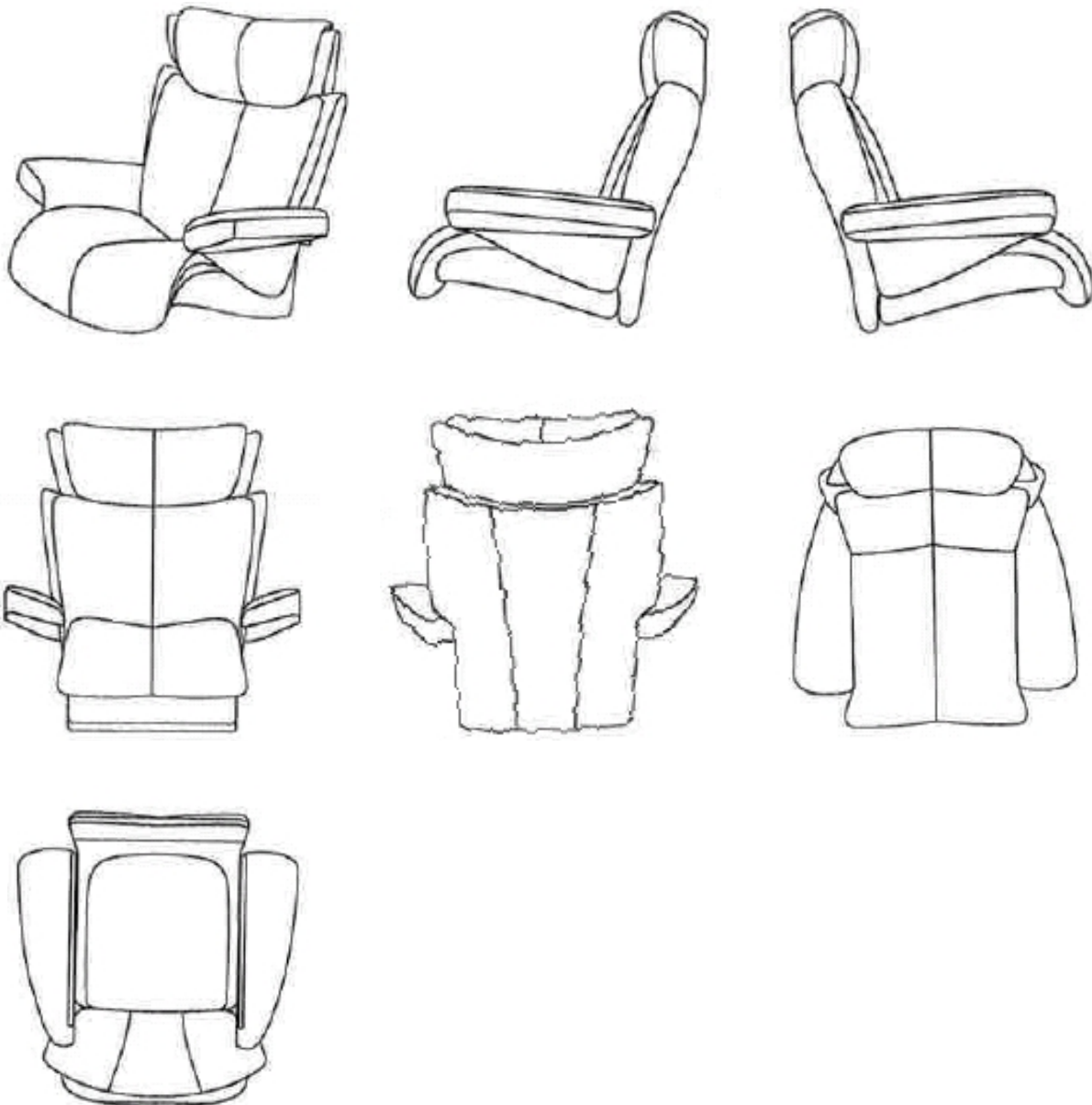

- (74) **Fullmektig:** Oslo Patentkontor AS, Postboks 7007 Majorstua, 0306 OSLO, NO  
(54) **Produkt:** Stol  
(51) **Klasse:** 06-01  
(73) **Innehaver:** Ekornes ASA, Postboks 23, 6222 IKORNNES, NO  
(72) **Designer:** Tone Kvello, C/o Ekornes ASA, Postboks 23, 6222 IKORNNES, NO

(11) **Reg.nr.:** 082783  
(21) **Søkn.nr.:** 20100436  
(22) **Inngitt:** 2010.08.27  
(24) **Løpedag:** 2010.08.27  
(43) **Allm. tilgj.:** 2011.01.27  
(15) **Registrert:** 2011.01.27  
(45) **Kunngjort:** 2011.02.21  
(18) **Reg. gjelder til:** 2015.08.27  
(55) **Avbildning(er):**

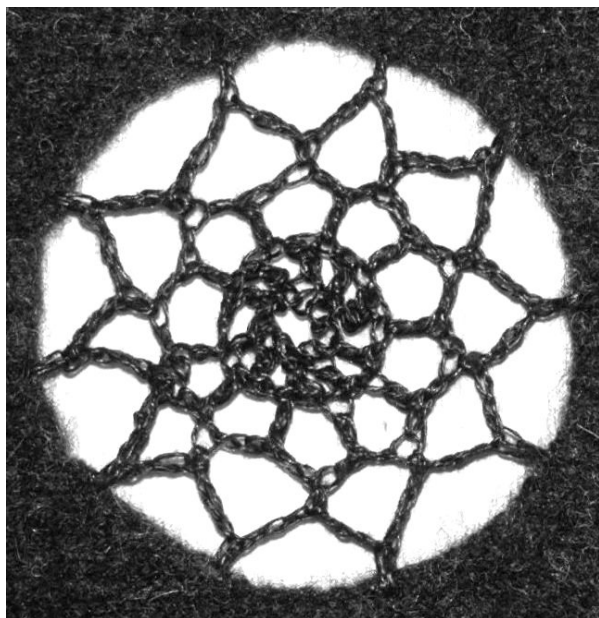

(54) **Produkt:** Logo  
(51) **Klasse:** 32-00  
(73) **Innehaver:** ATELIER STELLARIA v/Charlotte S.Engstad, Sørliveien 16, 9018 TROMSØ, NO  
(72) **Designer:** Charlotte Sissener Engstad, Sørliaavn. 16, 9018 TROMSØ, NO

---

- (11) **Reg.nr.:** 082784
- (21) **Søkn.nr.:** 20100381
- (22) **Inngitt:** 2010.08.03
- (24) **Løpedag:** 2010.08.03
- (43) **Allm. tilgj.:** 2010.08.03
- (15) **Registrert:** 2011.01.27
- (45) **Kunngjort:** 2011.02.21
- (18) **Reg. gjelder til:** 2015.08.03
- (55) **Avbildning(er):**

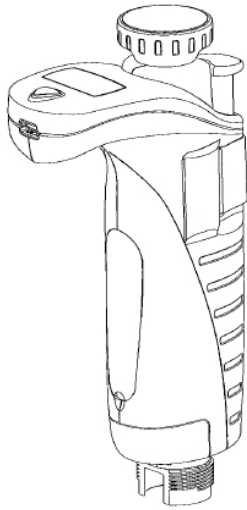

1.1

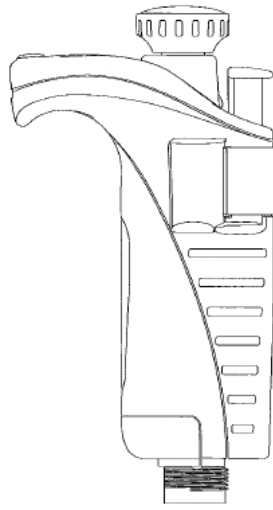

1.2

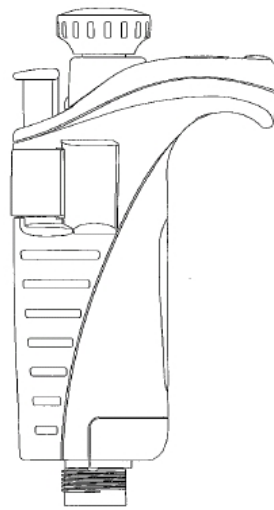

1.3

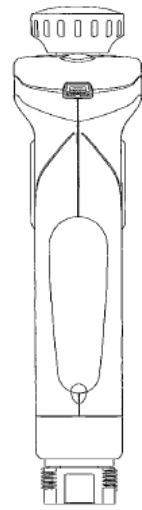

1.4

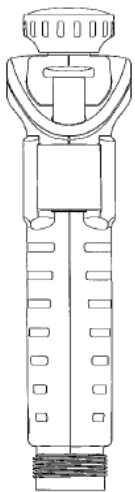

1.5



1.6

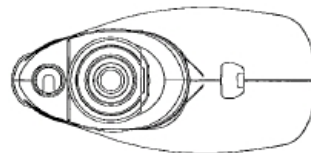

1.7

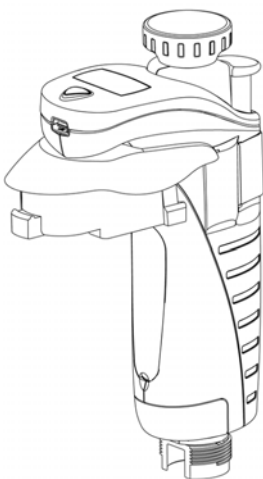

2.1

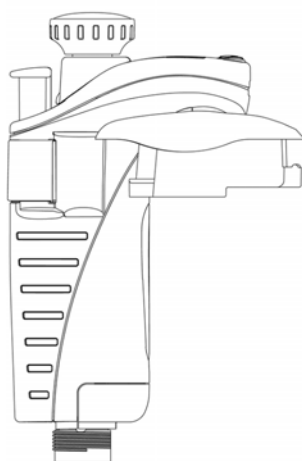

2.2

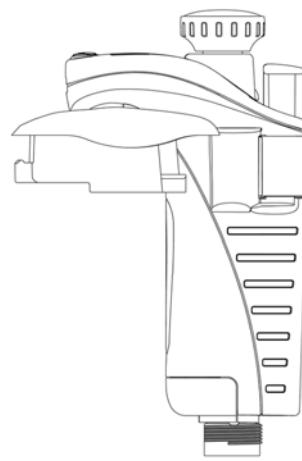

2.3

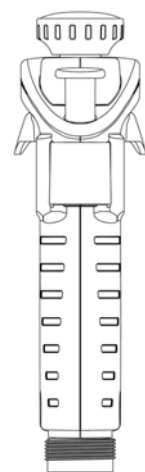

2.4

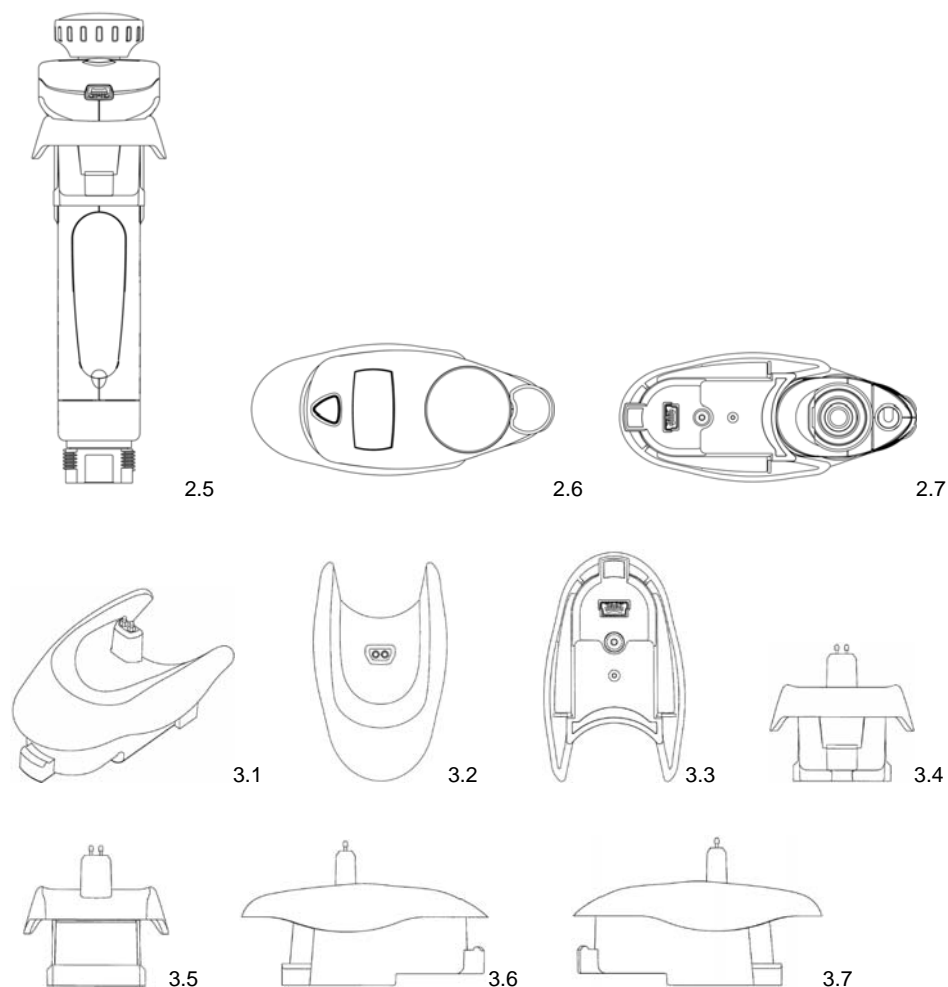

(74) **Fullmektig:** Zacco Norway AS, Postboks 2003 Vika, 0125 OSLO, NO

(54) **Produkt:**  
 1. Håndtaksdel av pipette  
 2. Håndtaksdel av pipette med adapter  
 3. Adapter til pipette

(51) **Klasse:** 1-3. 24-02

(73) **Innehaver:** Gilson SAS, 19 Avenue des Entrepreneurs, ZI Tissonvilliers BP 145, 95400 VILLIERS LE BEL, FR

(72) **Designer:** Hervé Malvoisin, 8 rue des tourelles, 75020 PARIS, FR  
 Sanjay Ramsamy, 60 route de garges bat: B esc : D, 95200 SARCELLES, FR

(30) **Prioritet:**  
 2010.02.05 US 29/355,335 (Design nr. 2)  
 2010.02.05 US 29/355,340 (Design nr. 3)  
 2010.02.05 US 29/355,344 (Design nr. 1)

(60) **Anmerkning:** Registreringen gjelder samregistrering.

- (11) **Reg.nr.:** 082785  
(21) **Søkn.nr.:** 20100527  
(22) **Inngitt:** 2010.10.21  
(24) **Løpedag:** 2010.10.21  
(43) **Allm. tilgj.:** 2010.10.21  
(15) **Registrert:** 2011.01.27  
(45) **Kunngjort:** 2011.02.21  
(18) **Reg. gjelder til:** 2015.10.21  
(55) **Avbildning(er):**

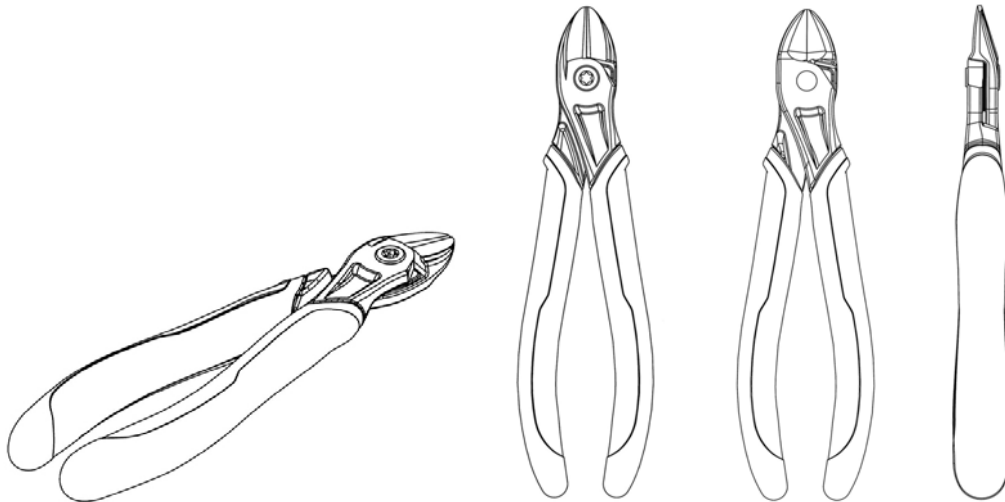

- (74) **Fullmektig:** Acapo AS, Postboks 1880 Nordnes, 5817 BERGEN, NO  
(54) **Produkt:** Tang  
(51) **Klasse:** 08-05  
(73) **Innehaver:** SNA EUROPE INDUSTRIES IBERIA SA, Antigua Carretera de Altube, Km. 5,5 (apdo. 307), 01080 VITORIA-GASTEIZ, ES  
(72) **Designer:** SNA EUROPE INDUSTRIES IBERIA SA, Antigua Carretera de Altube, Km. 5,5 (apdo. 307), 01080 VITORIA-GASTEIZ (ÁLAVA), ES  
(30) **Prioritet:** 2010.07.29 EM 001737750

(11)	Reg.nr.:	082786
(21)	Søkn.nr.:	20100283
(22)	Inngitt:	2010.05.26
(24)	Løpedag:	2010.05.26
(43)	Allm. tilgj.:	2010.05.26
(15)	Registrert:	2011.01.28
(45)	Kunngjort:	2011.02.21
(18)	Reg. gjelder til:	2015.05.26
(55)	Avbildning(er):	







Detaljutsnitt



Detaljutsnitt



Detaljutsnitt



Detaljutsnitt



Detaljutsnitt



Detaljutsnitt



Detaljutsnitt



Detaljutsnitt



Detaljutsnitt



Detaljutsnitt

- (54) **Produkt:** Padleåre for kajakk  
(51) **Klasse:** 12-06  
(73) **Innehaver:** Jan Myklebust, Høvåg, 4770 HØVÅG, NO  
(72) **Designer:** Jan Myklebust, Høvåg, 4770 HØVÅG, NO

- (11) **Reg.nr.:** 082787  
(21) **Søkn.nr.:** 20100528  
(22) **Inngitt:** 2010.10.27  
(24) **Løpedag:** 2010.10.27  
(43) **Allm. tilgj.:** 2010.10.27  
(15) **Registrert:** 2011.01.28  
(45) **Kunngjort:** 2011.02.21  
(18) **Reg. gjelder til:** 2015.10.27  
(55) **Avbildning(er):**



- (74) **Fullmektig:** Zacco Norway AS, Postboks 2003 Vika, 0125 OSLO, NO  
(54) **Produkt:** Strømbryter  
(51) **Klasse:** 13-03  
(73) **Innehaver:** ABB Technology AG, Affolternstrasse 44, 8050 ZÜRICH, CH  
(72) **Designer:** Dietmar Gentsch, Untere Steinhauser Strasse 26, 40882 RATINGEN, DE  
(30) **Prioritet:** 2010.04.28 EM 001701434  
(60) **Anmerking:** Designen er i farger.

(11) **Reg.nr.:** 082788  
(21) **Søkn.nr.:** 20100529  
(22) **Inngitt:** 2010.10.27  
(24) **Løpedag:** 2010.10.27  
(43) **Allm. tilgj.:** 2010.10.27  
(15) **Registrert:** 2011.01.28  
(45) **Kunngjort:** 2011.02.21  
(18) **Reg. gjelder til:** 2015.10.27  
(55) **Avbildning(er):**

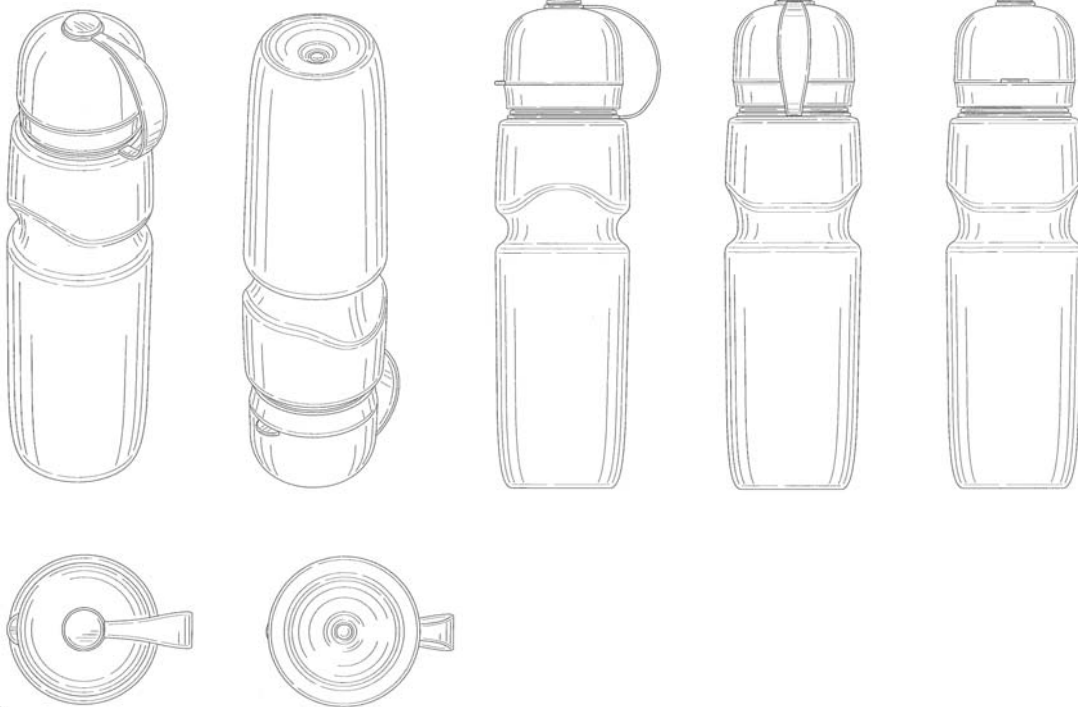

(74) **Fullmektig:** Zacco Norway AS, Postboks 2003 Vika, 0125 OSLO, NO  
(54) **Produkt:** Flaske  
(51) **Klasse:** 09-01  
(73) **Innehaver:** Dart Industries Inc, 14901 S. Orange Blossom Trail, FL32837 ORLANDO, US  
(72) **Designer:** Famia E Ablo, 12831 Madison Pointe Circle, Apt. 303, FL32821 ORLANDO, US  
(30) **Prioritet:** 2010.04.30 US 29/349,779

- (11) **Reg.nr.:** 082789
- (21) **Søkn.nr.:** 20100411
- (22) **Inngitt:** 2010.08.12
- (24) **Løpedag:** 2010.08.12
- (43) **Allm. tilgj.:** 2011.01.31
- (15) **Registrert:** 2011.01.31
- (45) **Kunngjort:** 2011.02.21
- (18) **Reg. gjelder til:** 2015.08.12
- (55) **Avbildning(er):**

Tekst tekst tekst Tekst tekst tekst	Logo etc	Valg valg valg valg <input type="checkbox"/>
< Side	Status- / Informasjonsfelt	Side >
Side >	Side >	Side >
Tekst tekst tekst tekst tekst tekst tekst tekst tekst tekst tekst tekst tekst tekst tekst tekst tekst tekst tekst  tekst tekst tekst tekst tekst tekst tekst tekst tekst tekst tekst tekst tekst tekst tekst tekst tekst tekst  <u>Lenke lenke lenke</u>  Tekst <input style="width: 50%;" type="text"/> <input style="width: 20%; text-align: center;" type="button" value="Aksjon aksjon aksjon"/>		
Tekst sdfasdf dfgsd d g d sgdh sdgh sd s v sdrf dgjh fvj d Tekst sdfasdf dfgsd d g d sgdh sdgh sd s v sdrf dgjh fvj ddghdghkl rtui Tekst sdfasdf dfgsd d g d sgdh sdgh sd s v sdrf dgjh fvj duyulyl Tekst sdfasdf dfgsd d g d sgdh sdgh sd s v sdrf dgjh fvj dtut Tekst sdfasdf dfgsd d g d sgdh sdgh sd s v sdrf dgjh fvj dfgdsf e tryu ty t tru rtui rt i Tekst sdfasdf dfgsd d g d sgdh sdgh sd s v sdrf dgjh fvj dtui Tekst sdfasdf dfgsd d g d sgdh sdgh sd s v sdrf dgjh fvj d titi rti rtui Tekst sdfasdf dfgsd d g d sgdh sdgh sd s v sdrf dgjh fvj dr beber6 6eve6 e6 Tekst sdfasdf dfgsd d g d sgdh sdgh sd s v sdrf dgjh fvj dr uyeb5e 56u Tekst sdfasdf dfgsd d g d sgdh sdgh sd s v sdrf dgjh fvj d5 56 yu		
Tekst tekst tekst tekst tekst tekst Tekst tekst tekst tekst tekst tekst		
Tekst tekst 010101010 tekst tekst tekst 010101010		

Tekst tekst tekst Tekst tekst tekst		Logo etc		Valg valg valg valg		▼	
< Side		Status- / Informasjonsfelt				Side >	
Side >	Side >	Side >	Side >	Side >	Side >	Side >	Side >
<p>Tekst tekst tekst tekst tekst tekst tekst tekst tekst tekst</p> <p>tekst tekst tekst tekst tekst tekst tekst tekst tekst tekst</p> <p><u>Lenke lenke lenke</u></p> <p>Tekst      ○ ○ ○ ○ ○ ○ ○ ○ ○ ○ ○ ○ ○ ○ ○ ○      Tekst</p> <p style="border: 1px dashed black; padding: 2px;">farge colour farge colour farge colour farge colour farge colour farge colour farge colour</p>							
Tekst sdfasdf dfgsd d g d sgdh sdgh sd s v sdrf dgjh fvj d							
Tekst sdfasdf dfgsd d g d sgdh sdgh sd s v sdrf dgjh fvj ddghdghkl rtui							
Tekst sdfasdf dfgsd d g d sgdh sdgh sd s v sdrf dgjh fvj duyulyl							
Tekst sdfasdf dfgsd d g d sgdh sdgh sd s v sdrf dgjh fvj dtut							
Tekst sdfasdf dfgsd d g d sgdh sdgh sd s v sdrf dgjh fvj dfgdsf e tryu ty t tru rtui rt i							
Tekst sdfasdf dfgsd d g d sgdh sdgh sd s v sdrf dgjh fvj dtui							
Tekst sdfasdf dfgsd d g d sgdh sdgh sd s v sdrf dgjh fvj d titi rti rtui							
Tekst sdfasdf dfgsd d g d sgdh sdgh sd s v sdrf dgjh fvj dr beber6 6eve6 e6							
Tekst sdfasdf dfgsd d g d sgdh sdgh sd s v sdrf dgjh fvj dr uye65e 56u							
Tekst sdfasdf dfgsd d g d sgdh sdgh sd s v sdrf dgjh fvj d5 56 yu							
Tekst tekst tekst tekst tekst tekst Tekst tekst tekst tekst tekst tekst							
						Tekst tekst 010101010 tekst tekst tekst 010101010	

2.1

Tekst tekst tekst Tekst tekst tekst		Logo etc		Valg valg valg valg		▼	
< Side		Status- / Informasjonsfelt				Side >	
Side >	Side >	Side >	Side >	Side >	Side >	Side >	Side >
<p>Tekst tekst tekst tekst tekst tekst tekst tekst tekst tekst</p> <p>tekst tekst tekst tekst tekst tekst tekst tekst tekst tekst</p> <p><u>Lenke lenke lenke</u></p> <p>Tekst      ○ ○ ○ ○ ○ ○ ○ ○ ○ ○ ○ ○ ○ ○ ○ ○      Tekst</p>							
Tekst sdfasdf dfgsd d g d sgdh sdgh sd s v sdrf dgjh fvj d							
Tekst sdfasdf dfgsd d g d sgdh sdgh sd s v sdrf dgjh fvj ddghdghkl rtui							
Tekst sdfasdf dfgsd d g d sgdh sdgh sd s v sdrf dgjh fvj duyulyl							
Tekst sdfasdf dfgsd d g d sgdh sdgh sd s v sdrf dgjh fvj dtut							
Tekst sdfasdf dfgsd d g d sgdh sdgh sd s v sdrf dgjh fvj dfgdsf e tryu ty t tru rtui rt i							
Tekst sdfasdf dfgsd d g d sgdh sdgh sd s v sdrf dgjh fvj dtui							
Tekst sdfasdf dfgsd d g d sgdh sdgh sd s v sdrf dgjh fvj d titi rti rtui							
Tekst sdfasdf dfgsd d g d sgdh sdgh sd s v sdrf dgjh fvj dr beber6 6eve6 e6							
Tekst sdfasdf dfgsd d g d sgdh sdgh sd s v sdrf dgjh fvj dr uye65e 56u							
Tekst sdfasdf dfgsd d g d sgdh sdgh sd s v sdrf dgjh fvj d5 56 yu							
Tekst tekst tekst tekst tekst tekst Tekst tekst tekst tekst tekst tekst							
						Tekst tekst 010101010 tekst tekst tekst 010101010	

3.1

Tekst tekst tekst Tekst tekst tekst		Logo etc		Valg valg valg valg		v	
< Side		Status- / Informasjonsfelt				Side >	
Side >	Side >	Side >	Side >	Side >	Side >	Side >	Side >
Tekst tekst				<input type="radio"/> Tekst tekst tekst tekst tekst <input type="radio"/> Tekst tekst tekst tekst tekst <input type="radio"/> Tekst tekst tekst tekst tekst <input type="radio"/> Tekst tekst tekst tekst tekst <input type="radio"/> Tekst tekst tekst tekst tekst <input type="radio"/> Tekst tekst tekst tekst tekst <input type="radio"/> Tekst tekst tekst tekst tekst <input type="radio"/> Tekst tekst tekst tekst tekst			
<a href="#">Lenke lenke lenke</a>							
Tekst sdfasdf dfgsd d g d sgdh sdgh sd s v sdrf dgjh fvj d Tekst sdfasdf dfgsd d g d sgdh sdgh sd s v sdrf dgjh fvj ddghdghkl rtui Tekst sdfasdf dfgsd d g d sgdh sdgh sd s v sdrf dgjh fvj duyulyl Tekst sdfasdf dfgsd d g d sgdh sdgh sd s v sdrf dgjh fvj dtut Tekst sdfasdf dfgsd d g d sgdh sdgh sd s v sdrf dgjh fvj dfgdsf e tryu ty t tru rtui rt i Tekst sdfasdf dfgsd d g d sgdh sdgh sd s v sdrf dgjh fvj dtui Tekst sdfasdf dfgsd d g d sgdh sdgh sd s v sdrf dgjh fvj d titi rti rtui Tekst sdfasdf dfgsd d g d sgdh sdgh sd s v sdrf dgjh fvj dr beber6 6eve6 e6 Tekst sdfasdf dfgsd d g d sgdh sdgh sd s v sdrf dgjh fvj dr uyeb5e 56u Tekst sdfasdf dfgsd d g d sgdh sdgh sd s v sdrf dgjh fvj d5 56 yu							
Tekst tekst tekst tekst tekst tekst Tekst tekst tekst tekst tekst tekst							
Tekst tekst 010101010 tekst tekst tekst 010101010							

4.1

Tekst tekst tekst Tekst tekst tekst		Logo etc		Valg valg valg valg		v	
< Side		Status- / Informasjonsfelt				Side >	
Side >	Side >	Side >	Side >	Side >	Side >	Side >	Side >
<input type="radio"/> Tekst tekst tekst tekst tekst <input type="radio"/> Tekst tekst tekst tekst tekst <input type="radio"/> Tekst tekst tekst tekst tekst <input type="radio"/> Tekst tekst tekst tekst tekst <input type="radio"/> Tekst tekst tekst tekst tekst <input type="radio"/> Tekst tekst tekst tekst tekst <input type="radio"/> Tekst tekst tekst tekst tekst <input type="radio"/> Tekst tekst tekst tekst tekst				Tekst tekst			
<a href="#">Lenke lenke lenke</a>							
Tekst sdfasdf dfgsd d g d sgdh sdgh sd s v sdrf dgjh fvj d Tekst sdfasdf dfgsd d g d sgdh sdgh sd s v sdrf dgjh fvj ddghdghkl rtui Tekst sdfasdf dfgsd d g d sgdh sdgh sd s v sdrf dgjh fvj duyulyl Tekst sdfasdf dfgsd d g d sgdh sdgh sd s v sdrf dgjh fvj dtut Tekst sdfasdf dfgsd d g d sgdh sdgh sd s v sdrf dgjh fvj dfgdsf e tryu ty t tru rtui rt i Tekst sdfasdf dfgsd d g d sgdh sdgh sd s v sdrf dgjh fvj dtui Tekst sdfasdf dfgsd d g d sgdh sdgh sd s v sdrf dgjh fvj d titi rti rtui Tekst sdfasdf dfgsd d g d sgdh sdgh sd s v sdrf dgjh fvj dr beber6 6eve6 e6 Tekst sdfasdf dfgsd d g d sgdh sdgh sd s v sdrf dgjh fvj dr uyeb5e 56u Tekst sdfasdf dfgsd d g d sgdh sdgh sd s v sdrf dgjh fvj d5 56 yu							
Tekst tekst tekst tekst tekst tekst Tekst tekst tekst tekst tekst tekst							
Tekst tekst 010101010 tekst tekst tekst 010101010							

5.1

- (54) **Produkt:** 1-5. Skjermbilde til dataprogram for kartlegginger  
 (51) **Klasse:** 1-5. 14-04  
 (73) **Innehaver:** FactBack AS, Postboks 173, 1751 HALDEN, NO  
 (72) **Designer:** FactBack AS, Postboks 173, 1751 HALDEN, NO  
 (60) **Anmerking:** Registreringen gjelder samregistrering.

- (11) **Reg.nr.:** 082790  
 (21) **Søkn.nr.:** 20100059  
 (22) **Inngitt:** 2010.02.11  
 (24) **Løpedag:** 2010.02.11  
 (43) **Allm. tilgj.:** 2010.08.11  
 (15) **Registrert:** 2011.01.31  
 (45) **Kunngjort:** 2011.02.21  
 (18) **Reg. gjelder til:** 2015.02.11  
 (55) **Avbildning(er):**

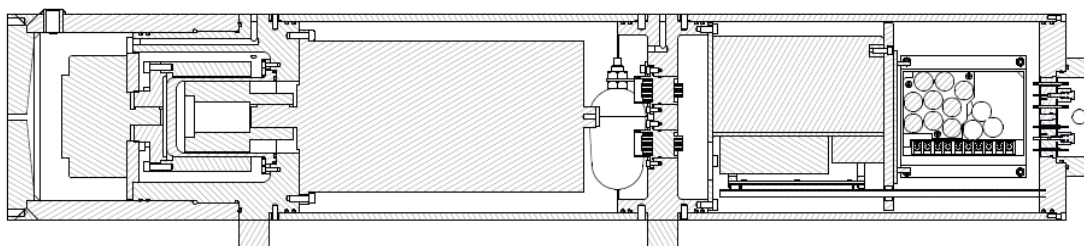
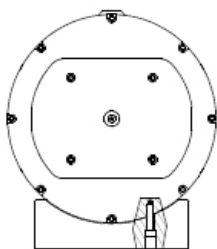
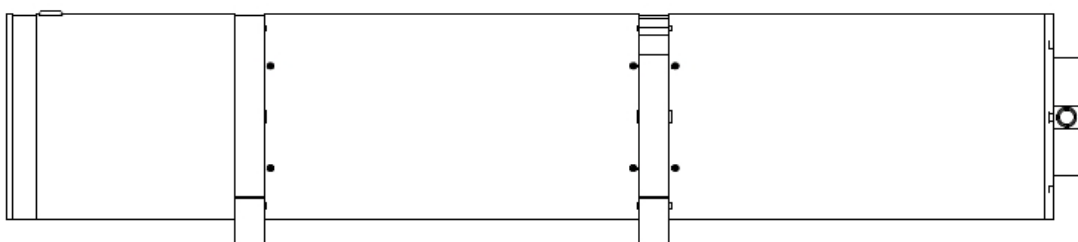

Tverrsnitt

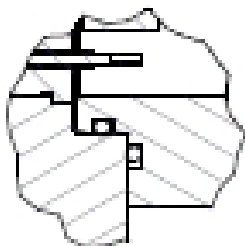

Detaljutsnitt av tverrsnitt

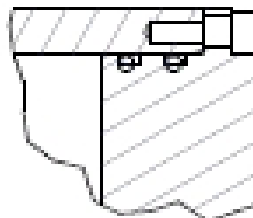

Detaljutsnitt av tverrsnitt

- (54) **Produkt:** Undervannspumpemodul  
 (51) **Klasse:** 15-02  
 (73) **Innehaver:** Tool Tech AS, Eldøyane 143, 5412 STORD, NO  
 (72) **Designer:** Egil Eriksen, 5428 FOLDRØYHAMN, NO

- (11) **Reg.nr.:** 082791  
(21) **Søkn.nr.:** 20100493  
(22) **Inngitt:** 2010.10.05  
(24) **Løpedag:** 2010.10.05  
(43) **Allm. tilgj.:** 2011.02.02  
(15) **Registrert:** 2011.02.02  
(45) **Kunngjort:** 2011.02.21  
(18) **Reg. gjelder til:** 2015.10.05  
(55) **Avbildning(er):**

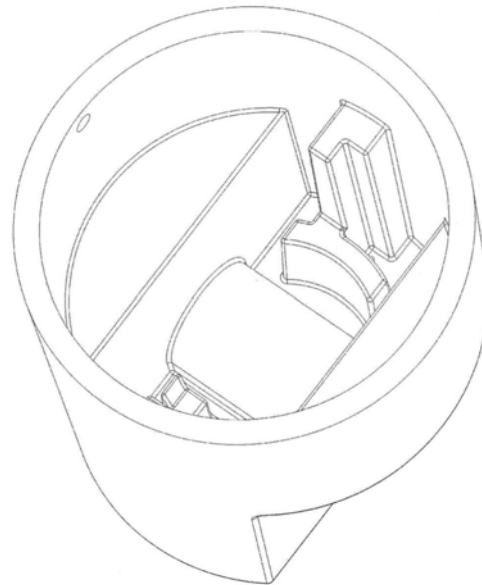
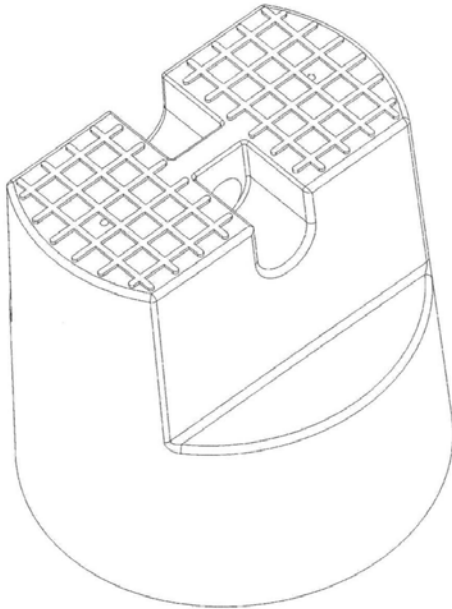

- (74) **Fullmektig:** Norsk Patentbyrå AS, Postboks 1204 Vika, 0110 OSLO, NO  
(54) **Produkt:** Frostsikringshette til bruk i kummer  
(51) **Klasse:** 23-01  
(73) **Innehaver:** Kongsberg Esco AS, Postboks 85, 3602 KONGSBERG, NO  
(72) **Designer:** Kongsberg Esco AS, Postboks 85, 3602 KONGSBERG, NO



(11)	<b>Reg.nr.:</b>	<b>082792</b>
(21)	<b>Søkn.nr.:</b>	20100515
(22)	<b>Inngitt:</b>	2010.10.13
(24)	<b>Løpedag:</b>	2010.10.13
(43)	<b>Allm. tilgj.:</b>	2011.02.02
(15)	<b>Registrert:</b>	2011.02.02
(45)	<b>Kunngjort:</b>	2011.02.21
(18)	<b>Reg. gjelder til:</b>	2015.10.13
(55)	<b>Avbildning(er):</b>	



(54)	<b>Produkt:</b>	Logo for mynter
(51)	<b>Klasse:</b>	32-00
(73)	<b>Innehaver:</b>	Vangdal Regnskap AS, Postboks 24, Bønes, 5849 BERGEN, NO
(72)	<b>Designer:</b>	Vangdal Regnskap AS, Postboks 24, Bønes, 5849 BERGEN, NO
(60)	<b>Anmerkning:</b>	Designen er i farger.

- (11) **Reg.nr.:** 082793  
(21) **Søkn.nr.:** 20100517  
(22) **Inngitt:** 2010.10.13  
(24) **Løpedag:** 2010.10.13  
(43) **Allm. tilgj.:** 2010.10.13  
(15) **Registrert:** 2011.02.02  
(45) **Kunngjort:** 2011.02.21  
(18) **Reg. gjelder til:** 2015.10.13  
(55) **Avbildning(er):**

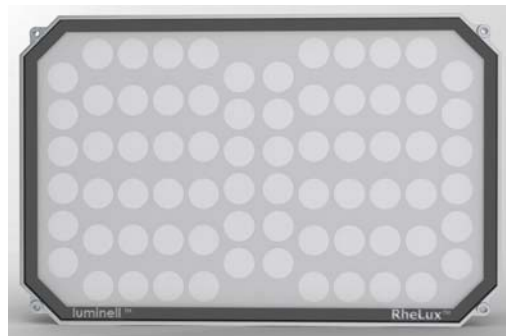



- (54) **Produkt:** Lysarmatur  
(51) **Klasse:** 26-03, 26-05  
(73) **Innehaver:** LUMINELL NORWAY AS, Myrabakken Næringscenter Bygg 2, 6010 ÅLESUND, NO  
(72) **Designer:** David Fink, Holmevatnet 11, 6020 ÅLESUND, NO
-

- (11) **Reg.nr.:** 082794  
(21) **Søkn.nr.:** 20100320  
(22) **Inngitt:** 2010.06.16  
(24) **Løpedag:** 2010.06.16  
(43) **Allm. tilgj.:** 2010.06.16  
(15) **Registrert:** 2011.02.02  
(45) **Kunngjort:** 2011.02.21  
(18) **Reg. gjelder til:** 2015.06.16  
(55) **Avbildning(er):**



1.1

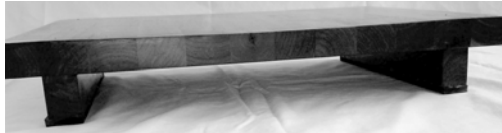

1.2



1.3

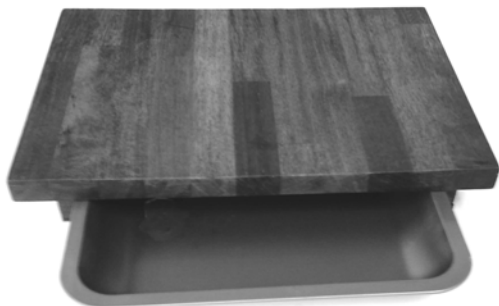

2.1

- (54) **Produkt:** 1. Skjærefjøl  
2. Skjærefjøl med oppsamlar  
(51) **Klasse:** 1-2. 07-04  
(73) **Innehaver:** Stig Einar Rygh-Johansen, Sundveien 3, 0198 OSLO, NO  
(72) **Designer:** Stig Einar Rygh-Johansen, Sundveien 3, 0198 OSLO, NO  
(60) **Anmerkning:** Registreringen gjelder samregistrering.

- (11) **Reg.nr.:** 082795  
(21) **Søkn.nr.:** 20100563  
(22) **Inngitt:** 2010.10.29  
(24) **Løpedag:** 2010.10.29  
(43) **Allm. tilgj.:** 2011.02.02  
(15) **Registrert:** 2011.02.02  
(45) **Kunngjort:** 2011.02.21  
(18) **Reg. gjelder til:** 2015.10.29  
(55) **Avbildning(er):**



1.1

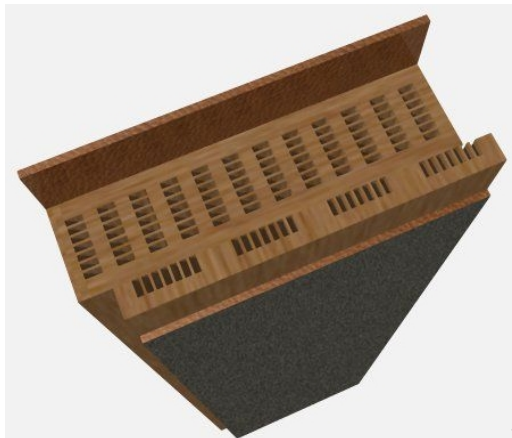

2.1

- (74) **Fullmektig:** Onsagers AS, Postboks 6963 St Olavs Plass, 0130 OSLO, NO  
(54) **Produkt:** 1-2. Bygningsmodul  
(51) **Klasse:** 1-2. 25-02  
(73) **Innehaver:** Treindustrienteret i Troms AS, Furøyvegen 129, 9310 SØRREISA, NO  
(72) **Designer:** Frode Løwø, Furøyvegen 129, 9310 SØRREISA, NO  
(60) **Anmerkning:** Designene er i farger.  
Registreringen gjelder samregistrering.

- (11) **Reg.nr.:** 082796  
(21) **Søkn.nr.:** 20100449  
(22) **Inngitt:** 2010.09.08  
(24) **Løpedag:** 2010.09.08  
(43) **Allm. tilgj.:** 2010.09.09  
(15) **Registrert:** 2011.02.03  
(45) **Kunngjort:** 2011.02.21  
(18) **Reg. gjelder til:** 2015.09.08  
(55) **Avbildning(er):**

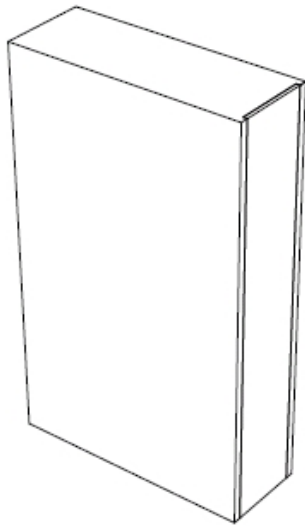

1.1



1.2



1.3



1.4

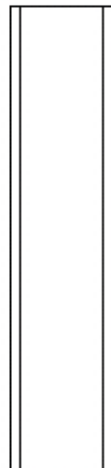

1.5

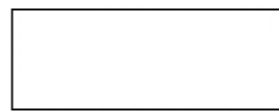

1.6



1.7

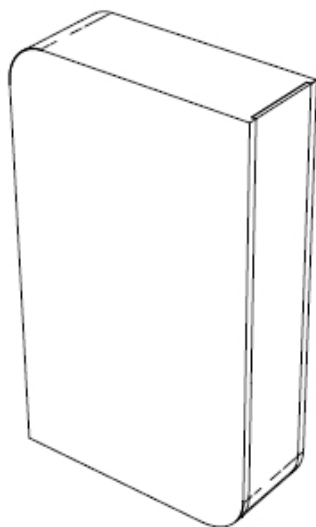

2.1



2.2



2.3

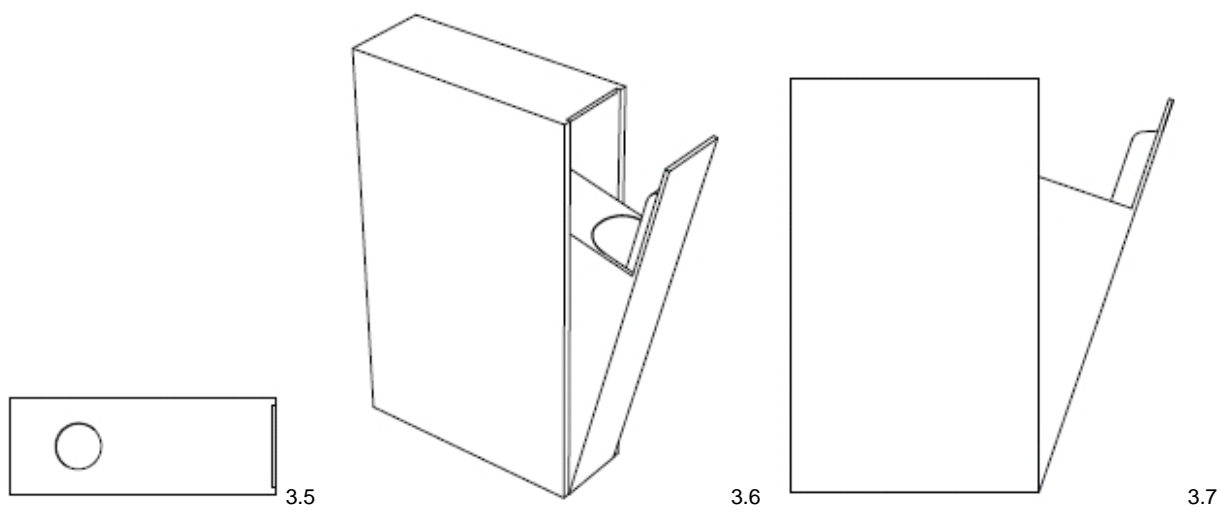
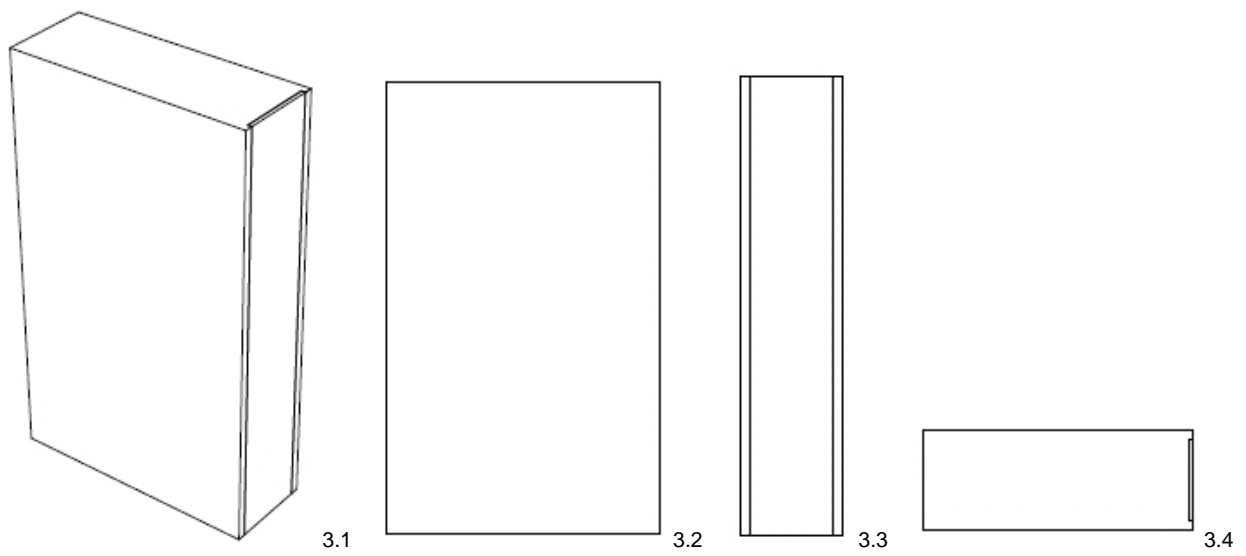
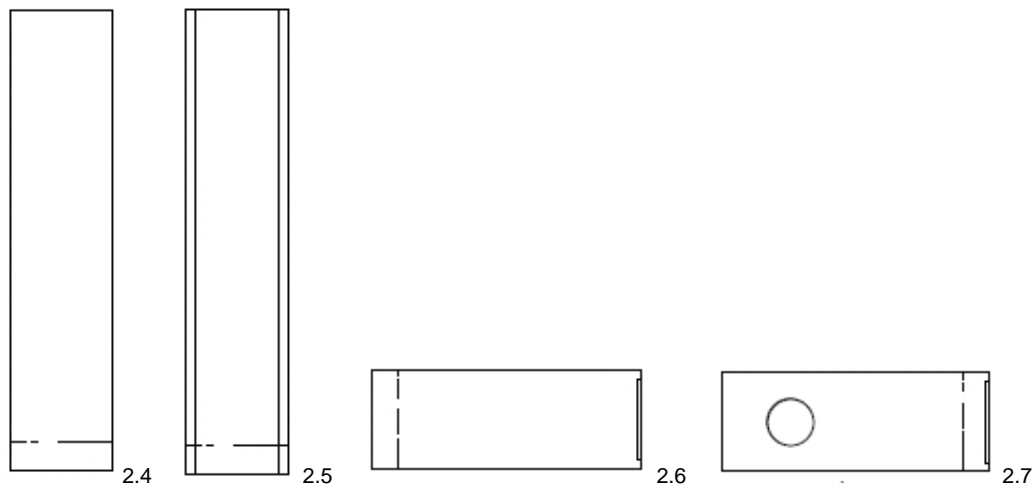

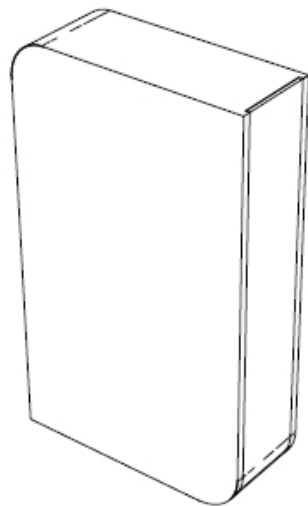

4.1



4.2

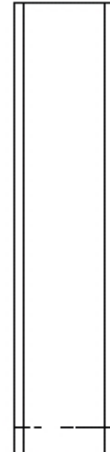

4.3



4.4



4.5

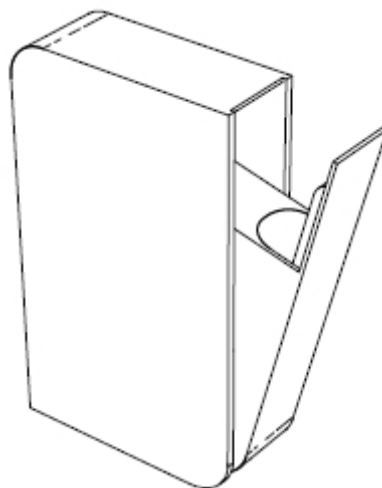

4.6

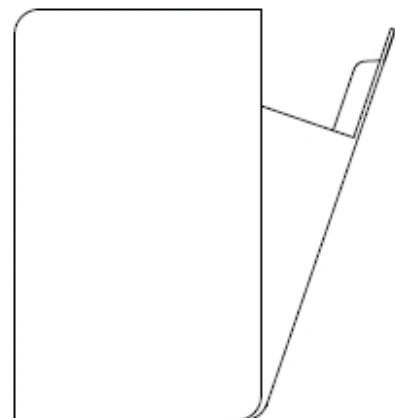

4.7

- (74) **Fullmektig:** Bryn Aarflot AS, Postboks 449 Sentrum, 0104 OSLO, NO  
(54) **Produkt:** 1-4. Simulert sigarettpakke  
(51) **Klasse:** 1-4. 09-03  
(73) **Innehaver:** Kind Consumer Ltd, Lighterman House, 23-36 Wharfdale Road, N19RY LONDON, GB  
(72) **Designer:** Alex Hearn, 33 Eagle House, 30 Eagle Wharf Road, N17EH LONDON, GB  
(30) **Prioritet:** 2010.03.09 EM 001201925  
(60) **Anmerking:** Registreringen gjelder samregistrering.



- (11) **Reg.nr.:** 082797
- (21) **Søkn.nr.:** 20100537
- (22) **Inngitt:** 2010.10.21
- (24) **Løpedag:** 2010.10.21
- (43) **Allm. tilgj.:** 2010.10.21
- (15) **Registrert:** 2011.02.03
- (45) **Kunngjort:** 2011.02.21
- (18) **Reg. gjelder til:** 2015.10.21
- (55) **Avbildning(er):**

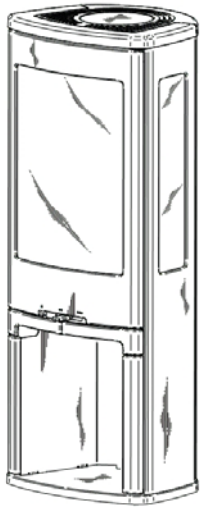

1.1

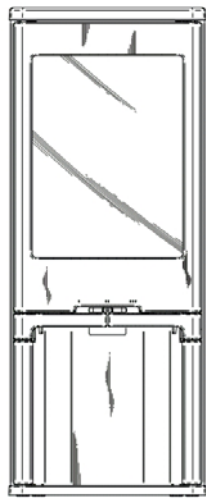

1.2

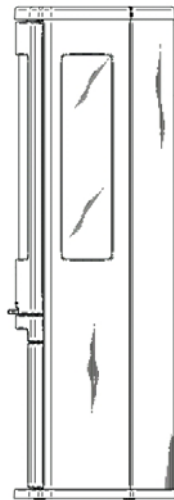

1.3



1.4



1.5



1.6

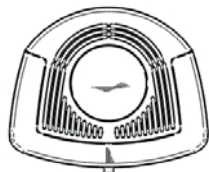

1.7



2.1

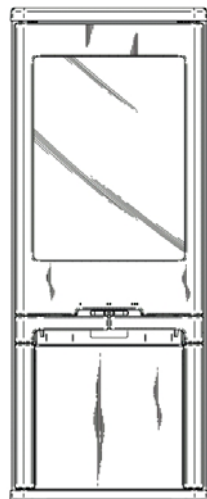

2.2

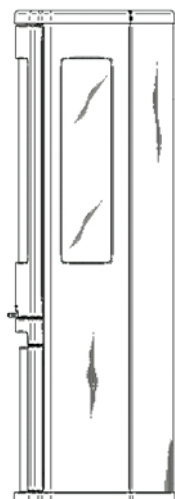

2.3

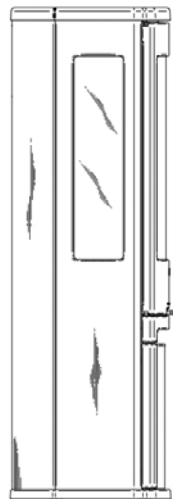

2.4



2.5

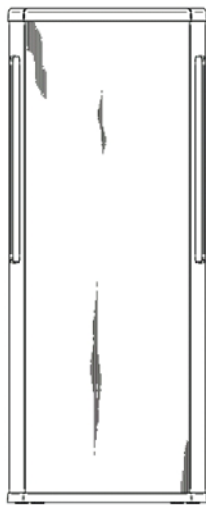

2.6

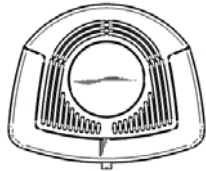

2.7

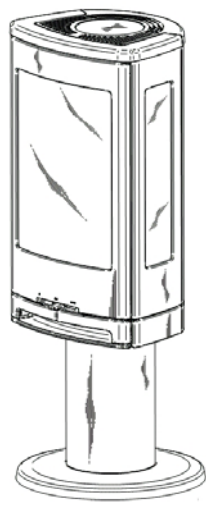

3.1

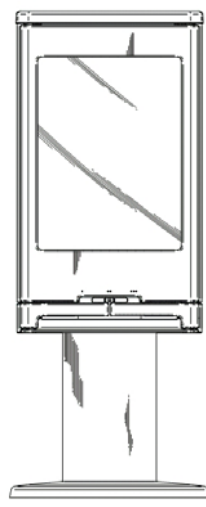

3.2

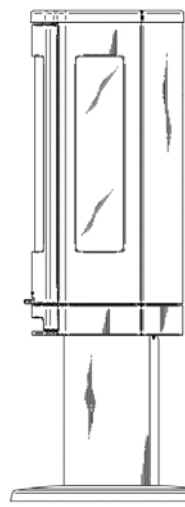

3.3

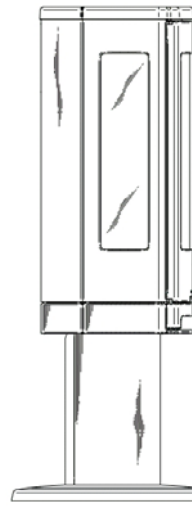

3.4

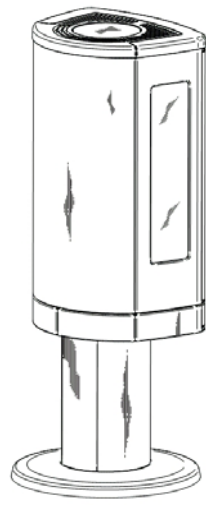

3.5



3.6

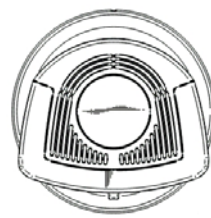

3.7

- (74) **Fullmektig:** Acapo AS, Postboks 1880 Nordnes, 5817 BERGEN, NO  
 (54) **Produkt:** 1-3. Kamin  
 (51) **Klasse:** 1-3. 23-03  
 (73) **Innehaver:** Nibe AB, Box 134, 28523 MARKARYD, SE  
 Johan Dahlberg, Riddarstigen 32, 18330 TÄBY, SE  
 Siri Johansson, Sedelvägen 5, 12932 HÄGERSTEN, SE  
 Magnus Olsson, Kalmgatan 32, 12145 JOHANNESHOV, SE  
 (30) **Prioritet:** 2010.10.15 EM 001239974  
 (60) **Anmerking:** Registreringen gjelder samregistrering.

## Internasjonale designregistreringer

(11)	Reg.nr.:	DM/073812
(21)	Søkn.nr.:	20100543
(22)	Inngitt:	2010.06.24
(24)	Løpedag:	2010.06.24
(43)	Allm. tilgj.:	2010.12.31
(15)	Registrert:	2010.06.24
(45)	Kunngjort:	2011.02.21
(18)	Reg. gjelder til:	2015.06.24
(55)	Avbildning(er):	

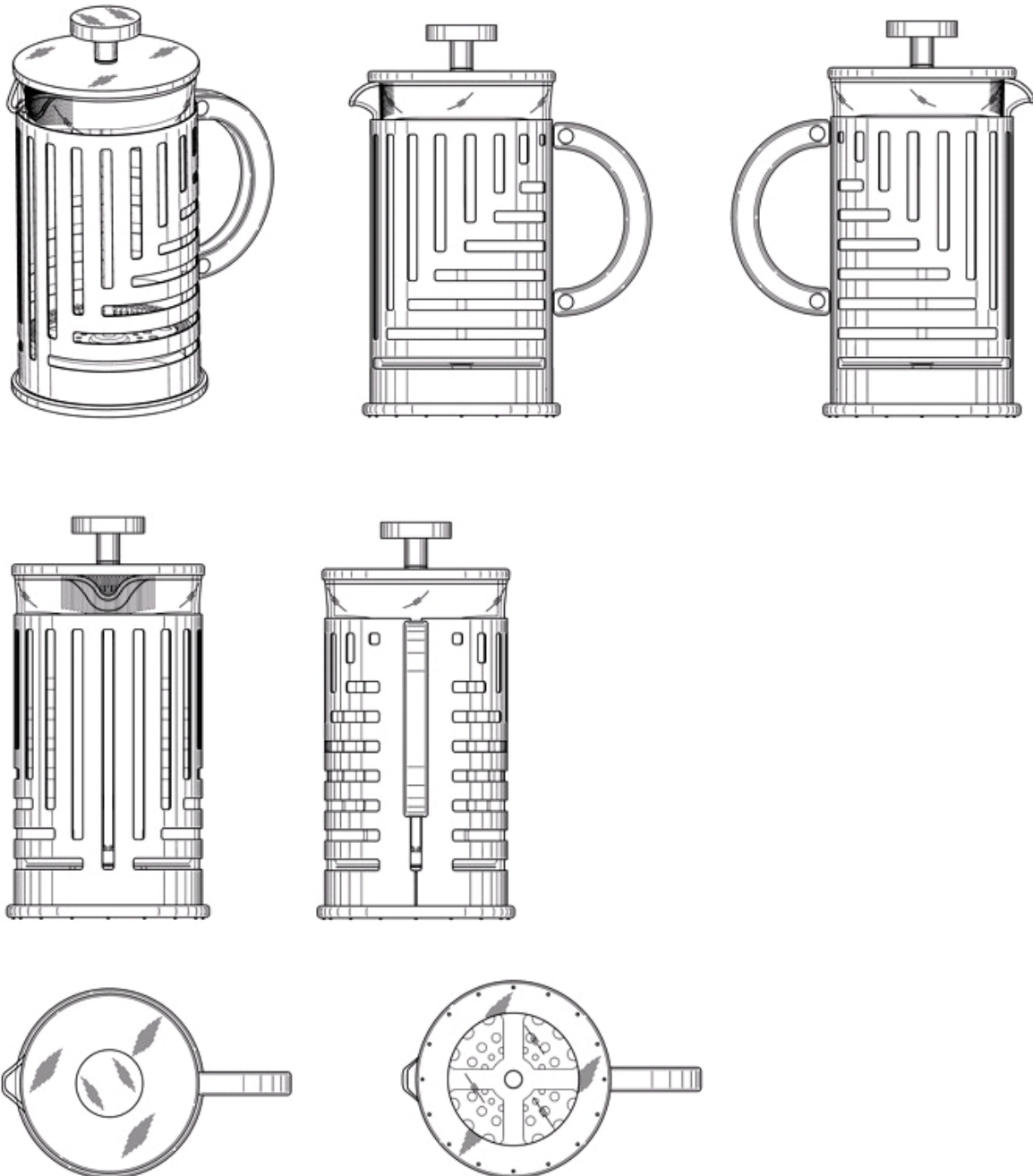

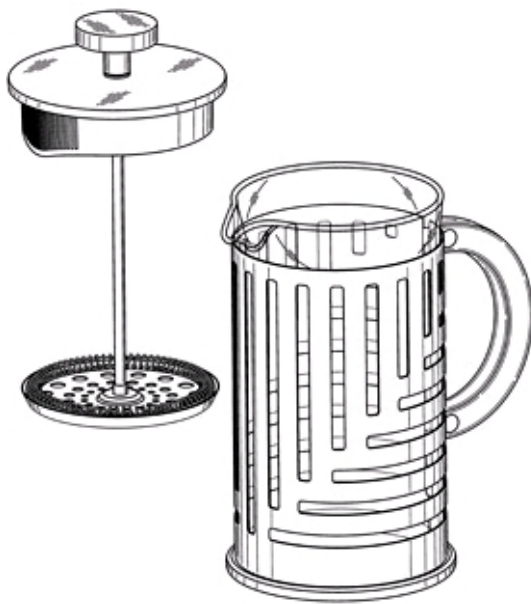

- (54) **Produkt:** Coffee maker  
(51) **Klasse:** 07-02  
(73) **Innehaver:** Pi-Design AG, Kantonsstrasse 100, 6234 TRIENGEN, CH  
(72) **Designer:** Jorgen Bodum, Käppelistrasse 15, 6045 MEGGEN, CH
-

- (11) Reg.nr.: DM/073978  
 (21) Søkn.nr.: 20100559  
 (22) Inngitt: 2010.06.17  
 (24) Løpedag: 2010.06.17  
 (43) Allm. tilgj.: 2010.12.31  
 (15) Registrert: 2010.06.17  
 (45) Kunngjort: 2011.02.21  
 (18) Reg. gjelder til: 2015.06.17  
 (55) Avbildning(er):

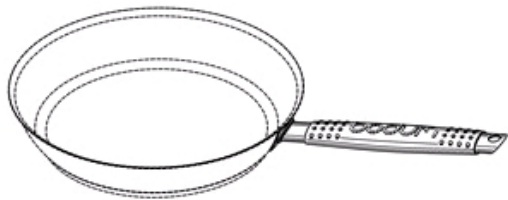

1.1

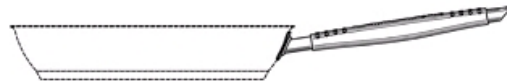

1.2

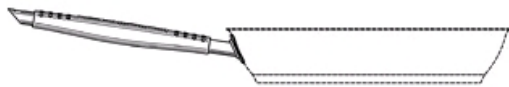

1.3



1.4

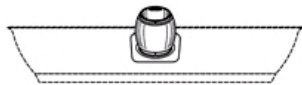

1.5

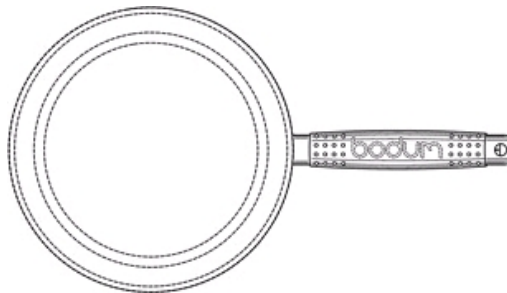

1.6

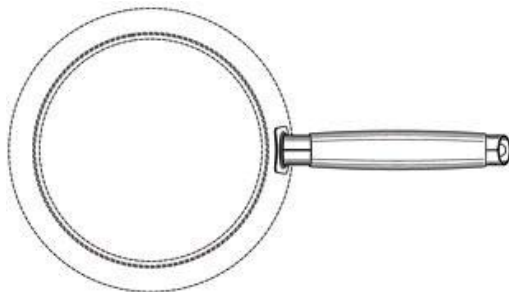

1.7

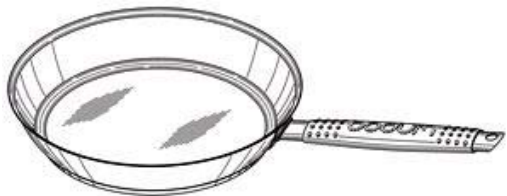

2.1

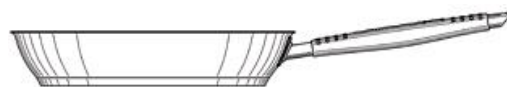

2.2



2.3



2.4

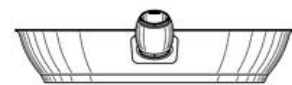

2.5

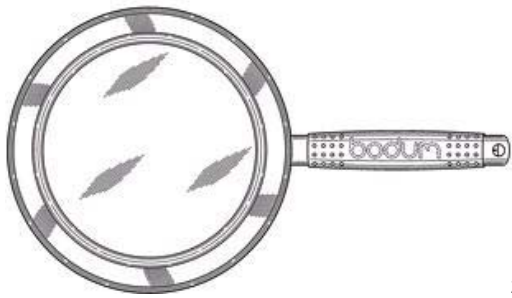

2.6

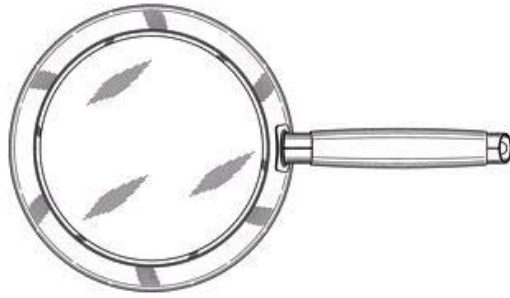

2.7

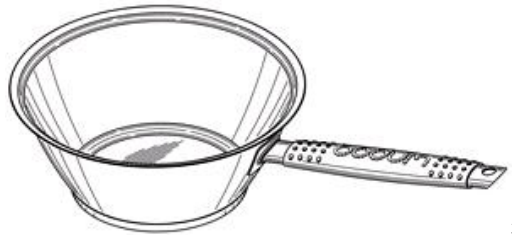

3.1



3.2



3.3



3.4

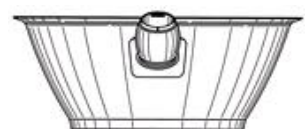

3.5

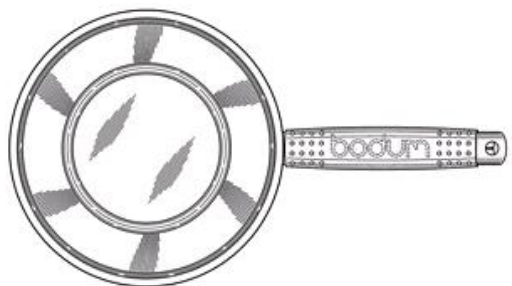

3.6

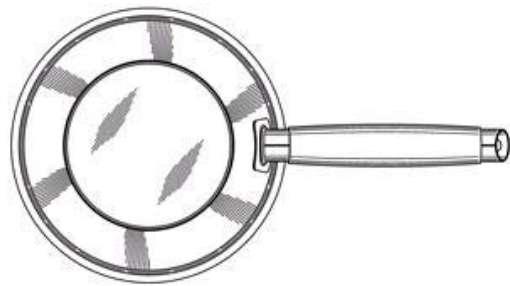

3.7

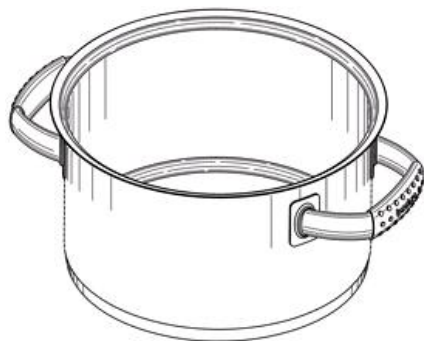

4.1

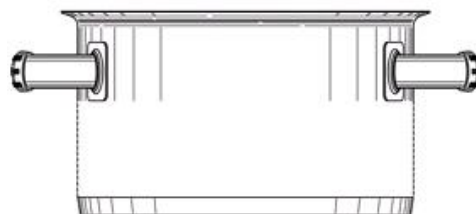

4.2

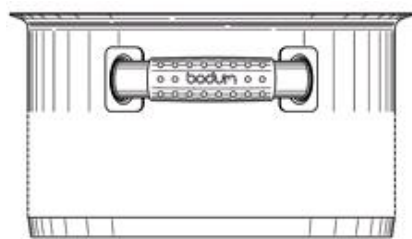

4.3

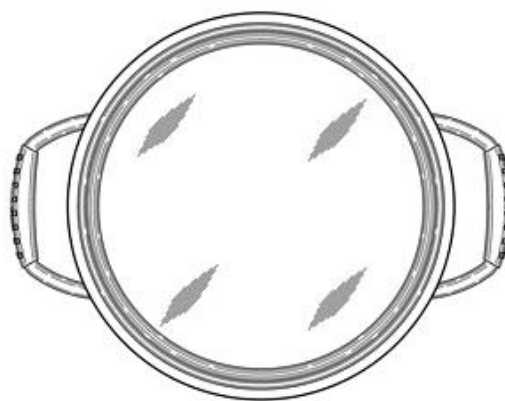

4.4

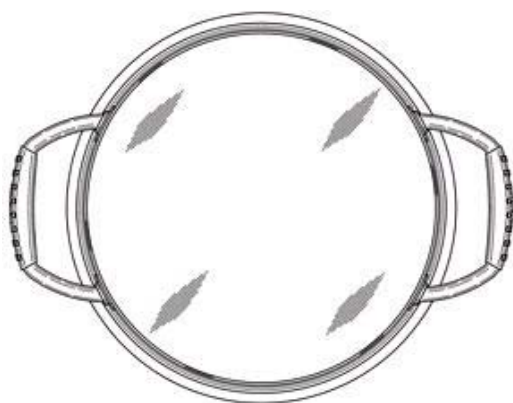

4.5



5.1

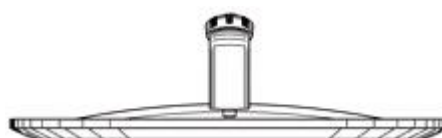

5.2

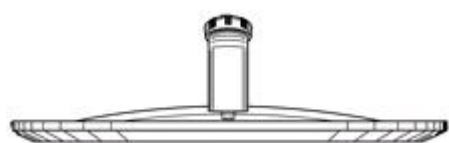

5.3

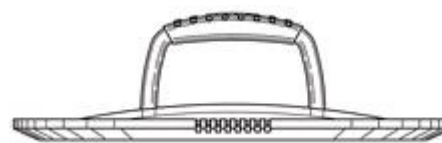

5.4

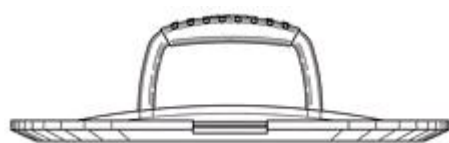

5.5

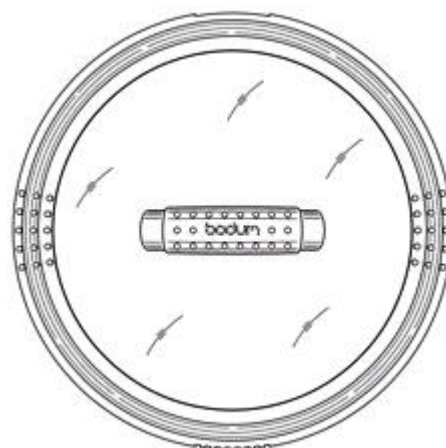

5.6

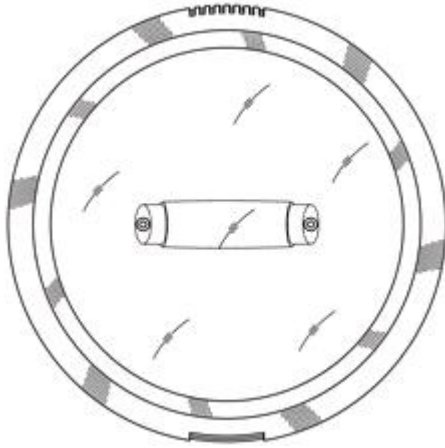

5.7

- (54) **Produkt:** 1. Handle for a frying pan, saute pan or casserole  
2. Frying pan  
3. Saute pan  
4. Cooking pot  
5. Lid for a cooking pot
- (51) **Klasse:** 1-5. 07-02
- (73) **Innehaver:** Pi-Design AG, Kantonsstrasse 100, 6234 TRIENGEN, CH
- (72) **Designer:** Jorgen Bodum, Käppelistrasse 15, 6045 MEGGEN, CH
- (60) **Anmerkning:** Registrerignen gjelder samregistrering.
-



(11) Reg.nr.: DM/074208  
(21) Søkn.nr.: 20100593  
(22) Inngitt: 2010.06.22  
(24) Løpedag: 2010.06.22  
(43) Allm. tilgj.: 2010.12.31  
(15) Registrert: 2010.06.22  
(45) Kunngjort: 2011.02.21  
(18) Reg. gjelder til: 2015.06.22  
(55) Avbildning(er):

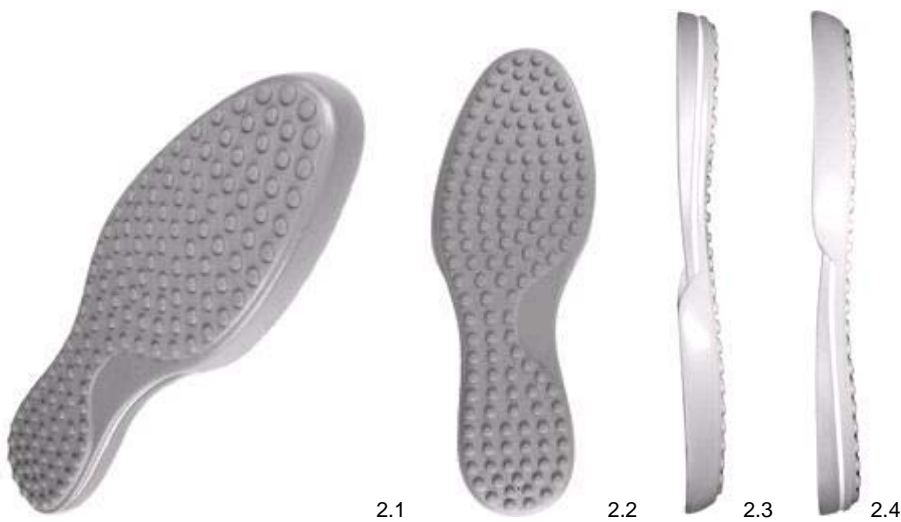
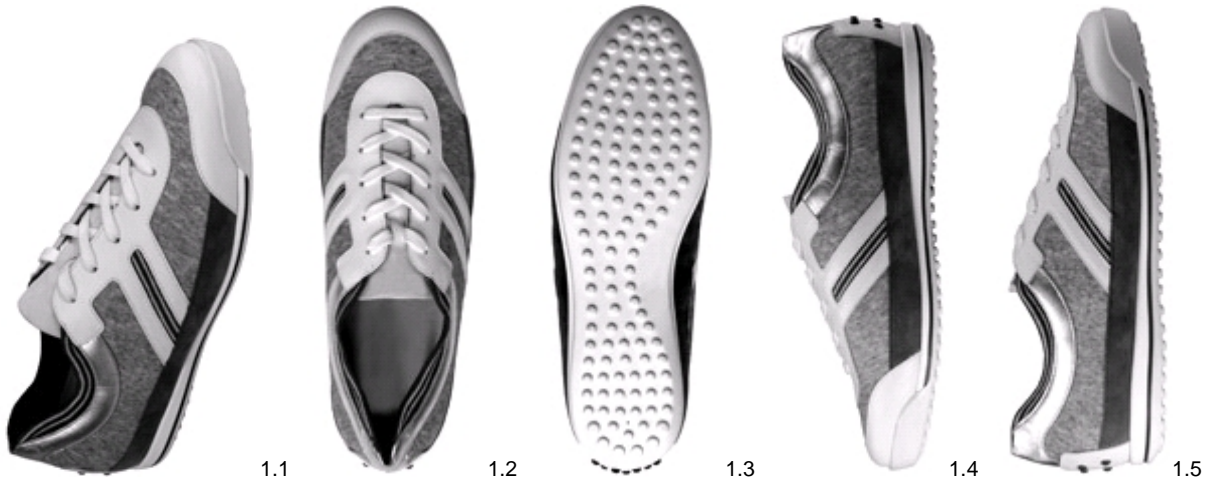



(54) **Produkt:** 1. Shoe  
2-4. Footwear soles

(51) **Klasse:** 1-4. 02-04

(73) **Innehaver:** Tod's SpA, Via Filippo Della Valle 1, 63019 SANT'ELPIDIO A MARE, IT

(72) **Designer:** Andrea Vico, Via Filippo Della Valle 1, 63019 SANT'ELPIDIO A MARE (FERMO), IT (Design nr. 2)  
Diego Della Valle, Via Filippo Della Valle 1, 63019 SANT'ELPIDIO A MARE (FERMO), IT (Design nr. 1-4)  
Daniele Bergonzi, Via Filippo Della Valle 1, 63019 SANT'ELPIDIO A MARE (FERMO), IT (Design nr. 3)  
Lucia Occhioni, Via Filippo Della Valle 1, 63019 SANT'ELPIDIO A MARE (FERMO), IT (Design nr. 1 og 4)

(30) **Prioritet:** 2009.12.24 EM 001652157

(60) **Anmerkning:** Registreringen gjelder samregistrering.

(11)	Reg.nr.:	DM/074209
(21)	Søkn.nr.:	20100594
(22)	Inngitt:	2010.06.22
(24)	Løpedag:	2010.06.22
(43)	Allm. tilgj.:	2010.12.31
(15)	Registrert:	2010.06.22
(45)	Kunngjort:	2011.02.21
(18)	Reg. gjelder til:	2015.06.22
(55)	Avbildning(er):	



1.1



1.2



1.3



1.4



1.5



1.6



1.7



2.1



2.2



2.3



2.4



2.5

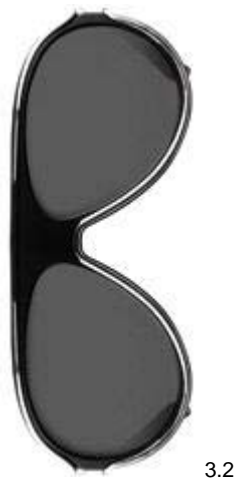



4.1



4.2



4.3



4.4



4.5



4.6



4.7



5.1



5.2



5.3



5.4



5.5

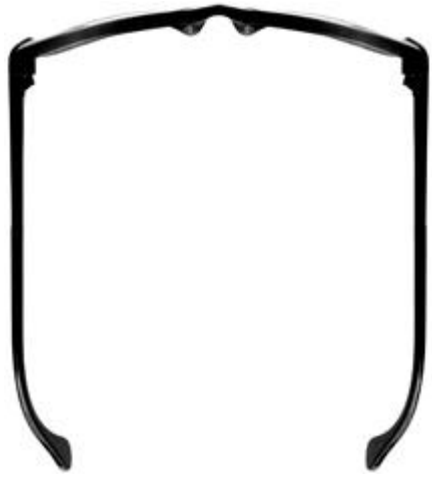

5.6



5.7



6.1



6.2



6.3



6.4



6.5



6.6



6.7



7.1



7.2



8.1



8.2

- (54) **Produkt:** 1-6. Spectacles  
7-8. Arms of spectacle frames
- (51) **Klasse:** 1-8. 16-06
- (73) **Innehaver:** Tod's SpA, Via Filippo Della Valle 1, 63019 SANT'ELPIDIO A MARE, IT
- (72) **Designer:** Andrea Della Valle, Via Filippo Della Valle 1, 63019 SANT'ELPIDIO A MARE (FERMO), IT (Design nr. 1, 2, 3, 4, 7)  
Diego Della Valle, Via Filippo Della Valle 1, 63019 SANT'ELPIDIO A MARE (FERMO), IT (Design nr. 5, 6, 8)  
Maurizio Coffen Marcolin, Piazza Crispi 8, 31100 TREVISO, IT (Design nr. 1- 8)
- (30) **Prioritet:** 2009.12.24 EM 001652207
- (60) **Anmerkning:** Registreringen gjelder samregistrering.

(11) **Reg.nr.:** DM/074456  
(21) **Søkn.nr.:** 20100687  
(22) **Inngitt:** 2010.09.28  
(24) **Løpedag:** 2010.09.28  
(43) **Allm. tilgj.:** 2010.11.30  
(15) **Registrert:** 2010.09.28  
(45) **Kunngjort:** 2011.02.21  
(18) **Reg. gjelder til:** 2015.09.28  
(55) **Avbildning(er):**



(54) **Produkt:** Wristwatch  
(51) **Klasse:** 10-02  
(73) **Innehaver:** Swatch AG (Swatch SA) (Swatch Ltd), Jakob-Stämpfli-Strasse 94, 2502 BIEL/BIENNE, CH  
(72) **Designer:** Rossana Boffi, Swatchlab, Via Archimede 6, 20129 MILANO, IT

---



(11) **Reg.nr.:** DM/074473  
(21) **Søkn.nr.:** 20100699  
(22) **Inngitt:** 2010.09.29  
(24) **Løpedag:** 2010.09.29  
(43) **Allm. tilgj.:** 2010.11.30  
(15) **Registrert:** 2010.09.29  
(45) **Kunngjort:** 2011.02.21  
(18) **Reg. gjelder til:** 2015.09.29  
(55) **Avbildning(er):**



(54) **Produkt:** 1-4. Wristwatches  
(51) **Klasse:** 1-4. 10-02  
(73) **Innehaver:** Swatch AG (Swatch SA) (Swatch Ltd), Jakob-Stämpfli-Strasse 94, 2502 BIEL/BIENNE, CH  
(72) **Designer:** Barbara Curti, Swatchlab, Via Archimede 6, 20129 MILANO, IT  
(60) **Anmerkning:** Designene er i farger.  
Registreringen gjelder samregistrering.

(11) **Reg.nr.:** DM/074475  
 (21) **Søkn.nr.:** 20100700  
 (22) **Inngitt:** 2010.09.29  
 (24) **Løpedag:** 2010.09.29  
 (43) **Allm. tilgj.:** 2010.11.30  
 (15) **Registrert:** 2010.09.29  
 (45) **Kunngjort:** 2011.02.21  
 (18) **Reg. gjelder til:** 2015.09.29  
 (55) **Avbildning(er):**



(54) **Produkt:** 1-7. Wristwatches  
 (51) **Klasse:** 1-7. 10-02  
 (73) **Innehaver:** Swatch AG (Swatch SA) (Swatch Ltd), Jakob-Stämpfli-Strasse 94, 2502 BIEL/BIENNE, CH  
 (72) **Designer:** Terje Haakonsen, Adm. Borresens vei 6G, 0286 OSLO, NO (Design nr. 1 og 2)  
 Jasmine Fung Hei Wah, Flat 3, 1/F, Ming Hoi House, Ming Nga Court, Tai Po, NT. HONG KONG, CN  
 (Design nr. 3-5)  
 Hideaki Kawashima, c/o Tomio Koyama Gallery, 1-3-2, MF, Kiyosumi, Koto-Ku TOKYO, JP  
 (Design nr. 6 og 7)  
 (60) **Anmerkning:** Design nr. 3, 4, 5, 6 og 7 er i farger.  
 Registreringen gjelder samregistrering.

- (11) Reg.nr.: DM/074495  
(21) Søkn.nr.: 20100690  
(22) Inngitt: 2010.09.03  
(24) Løpedag: 2010.09.03  
(43) Allm. tilgj.: 2010.11.30  
(15) Registrert: 2010.09.03  
(45) Kunngjort: 2011.02.21  
(18) Reg. gjelder til: 2015.09.03  
(55) Avbildning(er):

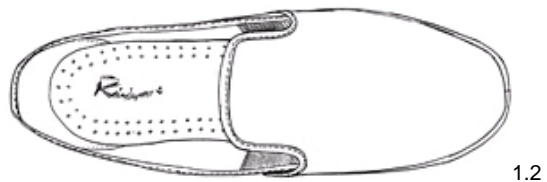
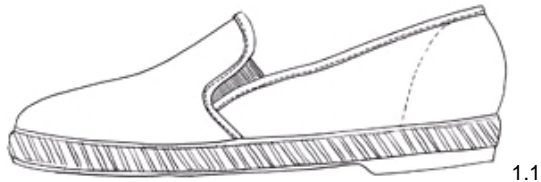



7.1



8.1

- (54) **Produkt:** 1-8. Footwear  
(51) **Klasse:** 1-8. 02-04  
(73) **Innehaver:** SarL Leisure Shoes, 4 rue du Marché Saint-Honoré, 75001 PARIS, FR  
(72) **Designer:** Dan Amzallag, 108 rue de la Folie Méricourt, 75011 PARIS, FR  
(60) **Anmerkning:** Design nr. 3, 4, 5, 6, 7 og 8 er i farger.  
Registreringen gjelder samregistrering.
-

(11) **Reg.nr.:** DM/074539  
(21) **Søkn.nr.:** 20100708  
(22) **Inngitt:** 2010.10.06  
(24) **Løpedag:** 2010.10.06  
(43) **Allm. tilgj.:** 2010.11.30  
(15) **Registrert:** 2010.10.06  
(45) **Kunngjort:** 2011.02.21  
(18) **Reg. gjelder til:** 2015.10.06  
(55) **Avbildning(er):**



(54) **Produkt:** Bottle for cosmetics  
(51) **Klasse:** 09-01  
(73) **Innehaver:** Guerlain SA, 68, avenue des Champs-Élysées, 75008 PARIS, FR  
(72) **Designer:** Sébastien Servaire, 283 boulevard Anatole France, 93200 SAINT-DENIS, FR  
(30) **Prioritet:** 2010.04.16 EM 001208912

(11) **Reg.nr.:** DM/074545  
(21) **Søkn.nr.:** 20100709  
(22) **Inngitt:** 2010.10.18  
(24) **Løpedag:** 2010.10.18  
(43) **Allm. tilgj.:** 2010.11.30  
(15) **Registrert:** 2010.10.18  
(45) **Kunngjort:** 2011.02.21  
(18) **Reg. gjelder til:** 2015.10.18  
(55) **Avbildning(er):**



(54) **Produkt:** 1-2. Flasks  
(51) **Klasse:** 1-2. 09-01  
(73) **Innehaver:** Beaute Prestige International, 28-32, Avenue Victor Hugo, 75116 PARIS, FR  
(72) **Designer:** Ross Lovegrove, 21 Powis Mews, W111JN LONDON, GB  
(30) **Prioritet:** 2010.04.20 EM 001697673  
(60) **Anmerkning:** Registreringen gjelder samregistrering.

(11) **Reg.nr.:** DM/074546  
 (21) **Søkn.nr.:** 20100710  
 (22) **Inngitt:** 2010.10.18  
 (24) **Løpedag:** 2010.10.18  
 (43) **Allm. tilgj.:** 2010.11.30  
 (15) **Registrert:** 2010.10.18  
 (45) **Kunngjort:** 2011.02.21  
 (18) **Reg. gjelder til:** 2015.10.18  
 (55) **Avbildning(er):**



(54) **Produkt:** 1-10. Wristwatches  
 (51) **Klasse:** 1-10. 10-02  
 (73) **Innehaver:** Swatch AG (Swatch SA) (Swatch Ltd), Jakob-Stämpfli-Strasse 94, 2502 BIEL/BIENNE, CH  
 (72) **Designer:** Gary Baseman, 137 North Larchmont Blvd. #129, CA90004 LOS ANGELES, US (Design nr. 1)  
 Joe Ledbetter, 915 Mateo St., Suite # 313, CA90021 LOS ANGELES, US (Design nr. 2)  
 Russel Valentine Karablin, SSUR, 1224 S. Ogden Dr., CA90019 LOS ANGELES, US (Design nr. 3)  
 Jeremy Andrew, "Jeremyville", Suite 514, 50-58 Macleay Street, NSW2011 POTTS POINT, AU (Design nr. 4)  
 Jeremy Madl, MAD Toy Design Inc, 8613 W 152nd Terrace, KS66223 OVERLAND PARK, US (Design nr. 5)  
 Frank Kozik, Happy Plastics, Inc., 577 14th Ave # 3, CA94118 SAN FRANCISCO, US (Design nr. 6, 9 og 10)  
 Tara McPherson, 173 Bedford Avenue # 3, 11211 BROOKLYN, US (Design nr. 7)  
 Cedric Mailharrou Fantomas, "Tilt", 7 route d'Agde, 31500 TOULOUSE, FR (Design nr. 8)  
 (60) **Anmerking:** Designene er i farger.  
 Registreringen gjelder samregistrering.

(11)	Reg.nr.:	DM/074600
(21)	Søkn.nr.:	20100668
(22)	Inngitt:	2010.10.14
(24)	Løpedag:	2010.10.14
(43)	Allm. tilgj.:	2010.11.30
(15)	Registrert:	2010.10.14
(45)	Kunngjort:	2011.02.21
(18)	Reg. gjelder til:	2015.10.14
(55)	Avbildning(er):	





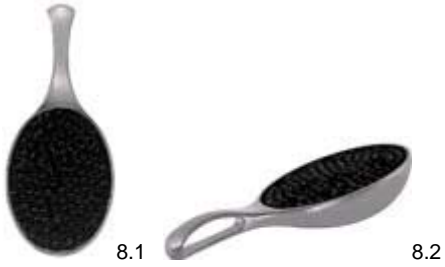
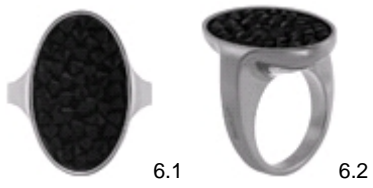



12.1



13.1



14.1



15.1



16.1



17.1



18.1



19.1



20.1



21.1



22.1



23.1



24.1



24.2



25.1



26.1



27.1



28.1

- (54) **Produkt:**
1. Necklace
  2. Ring
  3. Earrings
  4. Bracelet
  5. Necklace
  6. Ring
  7. Earrings
  8. Pendant
  9. Ring
  10. Earrings
  11. Bracelet
  12. Necklace
  13. Ring
  14. Bracelet
  15. Necklace
  16. Ring
  17. Earrings
  18. Bracelet
  - 19-20. Necklaces
  21. Ring
  22. Earrings
  23. Bracelet
  24. Necklace
  25. Ring
  26. Earrings
  27. Bracelet
  28. Necklace

(51) **Klasse:** 1-28. 11-01

(73) **Innehaver:** Swatch AG (Swatch SA) (Swatch Ltd), Jakob-Stämpfli-Strasse 94, 2502 BIEL/BIENNE, CH

(72) **Designer:** Iza Emch, c/o DYB Dress Your Body SA, Avenue Beauregard 12, 2036 CORMONDRECHE, CH (Design nr. 1 og 20-28)

Philippe Airaud, TSI Design, Rue St-Honoré 92-94, 75001 PARIS, FR (Design nr. 2-15)

Michaela Koch, Micha Design, Albrecht-Achilles-Str. 2, 10709 BERLIN, DE (Design nr. 16-19)

(60) **Anmerking:** Registreringen gjelder samregistrering.

## Fornyelse av registreringer

- Reg.nr: 069841 Fornyet til: 2016.03.25  
Innehaver: Ifö Sanitär AB, Box 140, 29522, BROMÖLLA, SE  
Fullmektig: Oslo Patentkontor AS, Postboks 7007 Majorstua, 0306, OSLO, NO
- Reg.nr: 070007 Fornyet til: 2016.03.25  
Innehaver: Ifö Sanitär AB, Box 140, 29522, BROMÖLLA, SE  
Fullmektig: Oslo Patentkontor AS, Postboks 7007 Majorstua, 0306, OSLO, NO
- Reg.nr: 071290 Fornyet til: 2015.12.14  
Innehaver: Koninklijke Philips Electronics NV, Groenewoudseweg 1, 5621BA Eindhoven, NL  
Fullmektig: Zacco Norway AS, Postboks 2003 Vika, 0125, OSLO, NO
- Reg.nr: 072737 Fornyet til: 2015.06.14  
Innehaver: Unilever NV, Weena 455, 3013AL, ROTTERDAM, NL  
Fullmektig: Zacco Norway AS, Postboks 2003 Vika, 0125, OSLO, NO
- Reg.nr: 073118 Fornyet til: 2016.01.29  
Innehaver: Hultafors AB, Hultaforsvägen 21, 51796, HULTAFORS, SE  
Fullmektig: Awapatent AB, Box 5117, 20071, MALMÖ, SE
- Reg.nr: 073165 Fornyet til: 2016.01.26  
Innehaver: Weber-Stephen products Co, 200 East Daniels Road, IL60067-6266, PALATINE, US  
Fullmektig: Bryn Aarflot AS, Postboks 449 Sentrum, 0104, OSLO, NO
- Reg.nr: 073389 Fornyet til: 2016.02.06  
Innehaver: Guerlain SA, 68, avenue des Champs-Élysées, 75008, PARIS, FR  
Fullmektig: Oslo Patentkontor AS, Postboks 7007 Majorstua, 0306, OSLO, NO
- Reg.nr: 076224 Fornyet til: 2015.12.19  
Innehaver: Koninklijke Philips Electronics NV, Groenewoudseweg 1, 5621BA, EINDHOVEN, NL  
Fullmektig: Zacco Norway AS, Postboks 2003 Vika, 0125, OSLO, NO
- Reg.nr: 076524 Fornyet til: 2016.02.09  
Innehaver: Henkel Loctite Adhesives Ltd, Apollo Court, 2 Bishop Square Business Park, AL10 9 EY, HATFIELD, HERTSFORDSHIRE, GB  
Fullmektig: Zacco Norway AS, Postboks 2003 Vika, 0125, OSLO, NO
- Reg.nr: 076743 Fornyet til: 2016.02.09  
Innehaver: Nintendo Co Ltd, 11-1 Hokotate-cho, Kamitoba, Minami-ku,, KYOTO-SHI, KYOTO, JP  
Fullmektig: Bryn Aarflot AS, Postboks 449 Sentrum, 0104, OSLO, NO
- Reg.nr: 076754 Fornyet til: 2015.12.07  
Innehaver: Tryg i Danmark smba, Klausdalsbrovej 601, 2750, BALLERUP, DK  
Fullmektig: Zacco Norway AS, Postboks 2003 Vika, 0125, OSLO, NO
- Reg.nr: 076903 Fornyet til: 2016.03.30  
Innehaver: Sinituote OY, Erskylän kartano 50, 05820, HYVINGE, FI  
Fullmektig: Zacco Norway AS, Postboks 2003 Vika, 0125, OSLO, NO

- Reg.nr: 079488 Fornyhet til: 2015.11.03  
Innehaver: V&S Finland OY, Panuntie 4, 00610, HELSINGFORS, FI  
Fullmektig: Zacco Norway AS, Postboks 2003 Vika, 0125, OSLO, NO
- Reg.nr: 079489 Fornyhet til: 2015.11.03  
Innehaver: V&S Finland OY, Panuntie 4, 00610, HELSINGFORS, FI  
Fullmektig: Zacco Norway AS, Postboks 2003 Vika, 0125, OSLO, NO
- Reg.nr: 079609 Fornyhet til: 2015.09.05  
Innehaver: Emap AS, Verftsgata 4, 7014, TRONDHEIM, NO
- Reg.nr: 079667 Fornyhet til: 2015.12.14  
Innehaver: Håvard Haktor Holstad, Norbyveien 2, 2817, GJØVIK, NO
- Reg.nr: 079752 Fornyhet til: 2016.03.02  
Innehaver: Øglænd System AS, Postboks 133, 4358, KLEPPE, NO  
Fullmektig: Håmsø Patentbyrå ANS, Postboks 171, 4302, SANDNES, NO
- Reg.nr: 079776 Fornyhet til: 2016.02.23  
Innehaver: Sandvik Mining and Construction OY, Pihtisulunkatu 9, 33330, TAMMERFORS, FI  
Fullmektig: Zacco Norway AS, Postboks 2003 Vika, 0125, OSLO, NO
- Reg.nr: 079846 Fornyhet til: 2016.02.24  
Innehaver: Peter Opsvik AS, Pilestredet 27 H, 0164, OSLO, NO  
Fullmektig: Zacco Norway AS, Postboks 2003 Vika, 0125, OSLO, NO
- Reg.nr: 079898 Fornyhet til: 2016.05.04  
Innehaver: Saverglass, 3 rue de la Gare, 60960, FEUQUIERES, FR  
Fullmektig: Bryn Aarflot AS, Postboks 449 Sentrum, 0104, OSLO, NO
- Reg.nr: 079926 Fornyhet til: 2016.02.08  
Innehaver: Microsoft Corp, One Microsoft Way, WA98052-6399, REDMOND, US  
Fullmektig: Bryn Aarflot AS, Postboks 449 Sentrum, 0104, OSLO, NO
- Reg.nr: 080064 Fornyhet til: 2016.04.28  
Innehaver: Grether AG, Parkstrasse 5, 4102, BINNINGEN, CH  
Fullmektig: Oslo Patentkontor AS, Postboks 7007 Majorstua, 0306, OSLO, NO
- Reg.nr: 080123 Fornyhet til: 2016.01.26  
Innehaver: Norsk Matraps BA, c/o Det kgl selskap for Norges vel, Postboks 115, 2026, SKJETTEN, NO  
Fullmektig: Kristian Foss, Gille Advokater DA, Postboks 1037 Hoff, 0218, OSLO, NO