



PATENTSTYRET
Styret for det industrielle rettsvern

nr 19/09 - 2009.09.07 NO

årgang 7

ISSN 1503-5808

Norsk

design tidende

www.patentstyret.no

Norsk designtidende er en publikasjon som inneholder kunngjøringer innenfor designområdet

BESØKSADRESSE

- ▶ Københavngaten 10

POSTADRESSE

- ▶ Postboks 8160 Dep.
0033 Oslo

E-POST

- ▶ mail@patentstyret.no

TELEFON

- ▶ 22 38 73 00

TELEFAKS

- ▶ 22 38 73 01

INFOSENTERETS TELEFONTID

- ▶ kl. 09.00 - 15.00
Telefon (+47) 22 38 73 33
Telefaks (+47) 22 38 73 31

Innholdsfortegnelse:

Registrerte design	3
Fornyelse av registreringer	40

INID-koder

I kunngjøringene er de enkelte data forsynt med koder overensstemmende med INID-kodesystemet

(INID= Internationally agreed Numbers for the Identification of Data).

- (11) Registreringsnummer
- (15) Registreringsdato
- (18) Dato som registreringen gjelder til
- (21) Søknadsnummer
- (22) Inngivelsesdato
- (24) Løpedag
- (30) Prioritetsopplysninger
- (43) Allment tilgjengelig dato
- (51) Klasse
- (54) Produkt
- (55) Avbildning(er)
- (72) Designer
- (73) Innehaver
- (74) Fullmektig

Registrerte design

I henhold til designloven § 18 første ledd i.f. kunngjøres i dag følgende registrerte design.

Det kan fremsettes krav om at designregistreringen helt eller delvis skal oppheves, jf. designloven §§ 25 flg. og designforskriften §§ 26 flg.

Designregistreringen gjelder for den eller de periodene på fem år som søknaden er innlevert for, regnet fra søknadsdagen. Registreringen kan fornyes, jf. designloven §§ 23 og 24. Maksimal beskyttelsestid er 25 år. For reservedeler, se unntaket i designloven § 23 annet ledd.

(11)	Reg.nr.:	081887
(21)	Søkn.nr.:	20080694
(22)	Inngitt:	2008.12.23
(43)	Allm. tilgj.:	2008.12.23
(15)	Registrert:	2009.08.11
(45)	Kunngjort:	2009.09.07
(18)	Reg. gjelder til:	2013.12.23
(55)	Avbildning(er):	

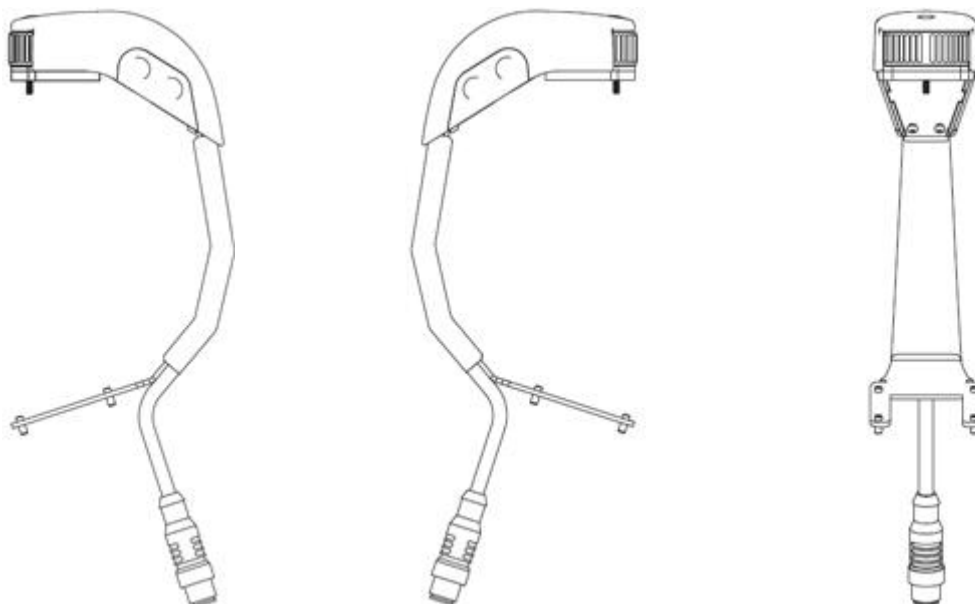

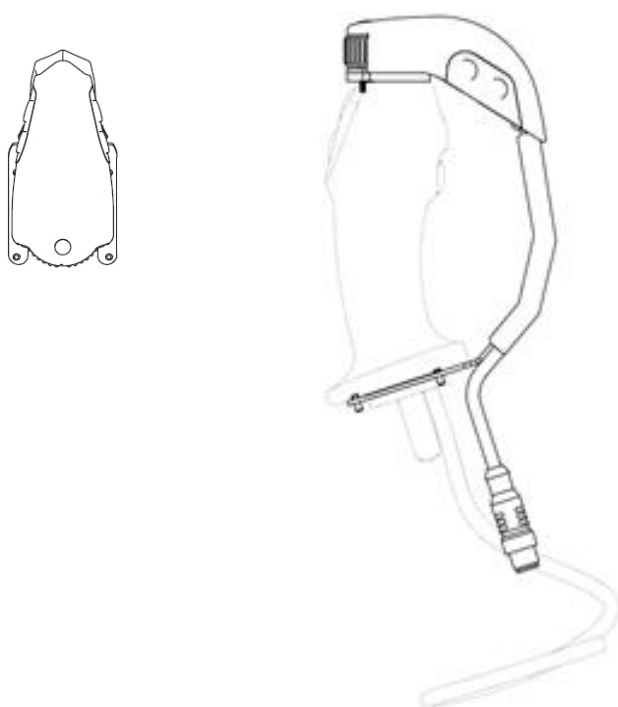

(74)	Fullmektig:	Acapo AS, Postboks 1880 Nordnes, 5817 BERGEN, NO
(54)	Produkt:	Tilbehør til styrespak
(51)	Klasse:	12-16
(73)	Innehaver:	Bestus AB, Industrivägen 8, 90130 UMEÅ, SE
(72)	Designer:	Bertil Hammarström, Norra Gimonäsvägen 61, 90738 UMEÅ, SE
(30)	Prioritet:	2008.07.14 EM 000973177

- (11) **Reg.nr.:** 081888
(21) **Søkn.nr.:** 20090061
(22) **Inngitt:** 2009.02.03
(43) **Allm. tilgj.:** 2009.08.03
(15) **Registrert:** 2009.08.11
(45) **Kunngjort:** 2009.09.07
(18) **Reg. gjelder til:** 2014.02.03
(55) **Avbildning(er):**



- (54) **Produkt:** Fiskeredskap for stang
(51) **Klasse:** 22-05
(73) **Innehaver:** Odd Steinar Solhaug, Rønningsveien 9, 7560 VIKHAMMER, NO
(72) **Designer:** Odd Steinar Solhaug, Rønningsveien 9, 7560 VIKHAMMER, NO
(60) **Anmerkning:** Modell er innlevert.
Designen er i farger.

- (11) **Reg.nr.:** 081889
 (21) **Søkn.nr.:** 20090137
 (22) **Inngitt:** 2009.03.16
 (43) **Allm. tilgj.:** 2009.03.24
 (15) **Registrert:** 2009.08.17
 (45) **Kunngjort:** 2009.09.07
 (18) **Reg. gjelder til:** 2014.03.16
 (55) **Avbildning(er):**

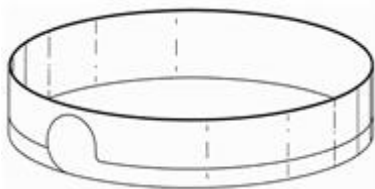

1.1



1.2



1.3

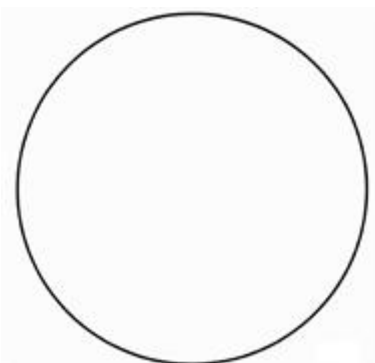

1.4

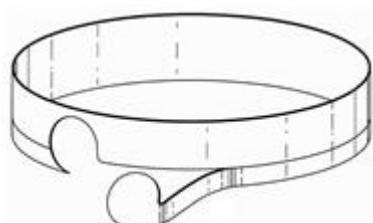

1.5

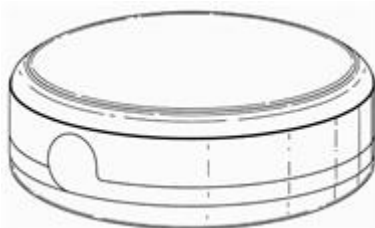

2.1

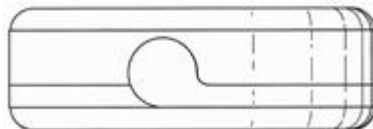

2.2

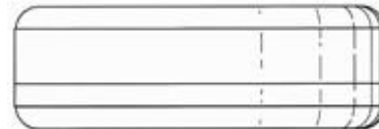

2.3

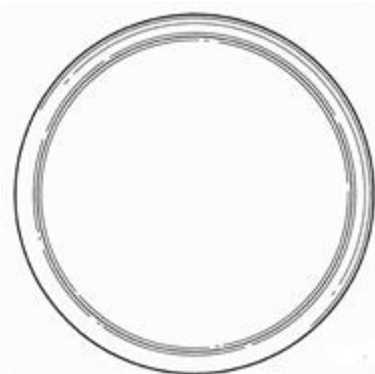

2.4

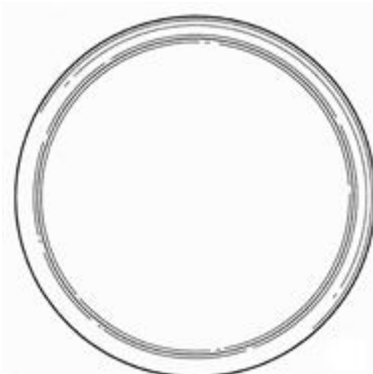

2.5

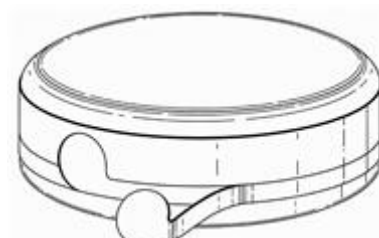

2.6

- (74) **Fullmektig:** Zacco Norway AS, Postboks 2003 Vika, 0125 OSLO, NO
 (54) **Produkt:** 1. Lukkeanordning for beholder
 2. Beholder med lukkeanordning
 (51) **Klasse:** 1. 09-07
 2. 09-03
 (73) **Innehaver:** British American Tobacco (Investments) Ltd, Globe House, 1 Water Street, WC2R3LA LONDON, GB
 (72) **Designer:** Aaron McKenzie, c/o British American Tobacco (Investments) Ltd, Globe House, 1 Water Street, WC2R3LA LONDON, GB
 (30) **Prioritet:** 2008.09.24 EM 001010078
 (60) **Anmerkning:** Registreringen gjelder samregistrering.

(11)	Reg.nr.:	081890
(21)	Søkn.nr.:	20090152
(22)	Inngitt:	2009.03.19
(43)	Allm. tilgj.:	2009.03.26
(15)	Registrert:	2009.08.18
(45)	Kunngjort:	2009.09.07
(18)	Reg. gjelder til:	2014.03.19
(55)	Avbildning(er):	



1.1



1.2



1.3

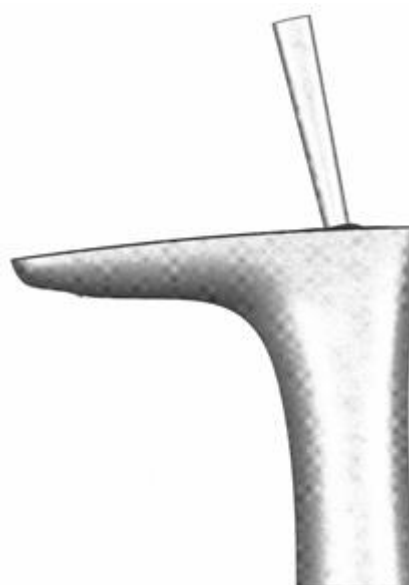

1.4



1.5

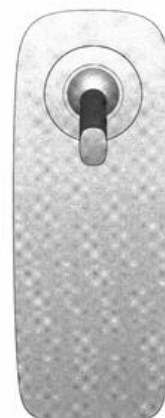

1.6



1.7



2.1

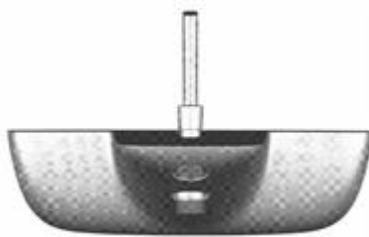

2.2

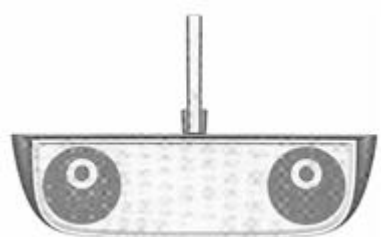

2.3

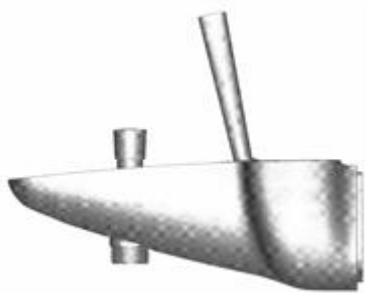

2.4

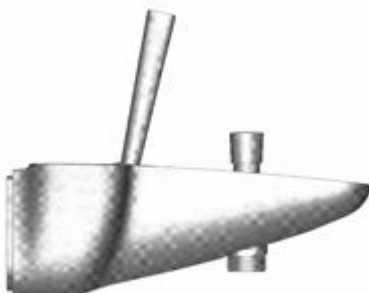

2.5



2.6



2.7



3.1

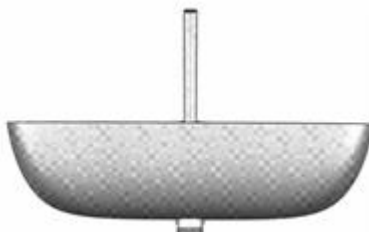

3.2

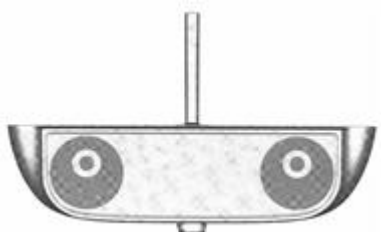

3.3



3.4



3.5



3.6



3.7



4.1

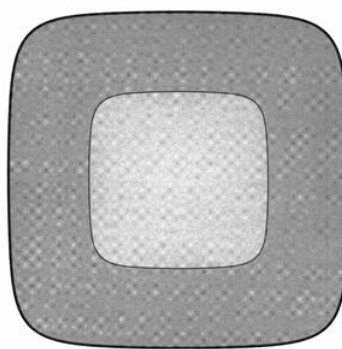

4.2

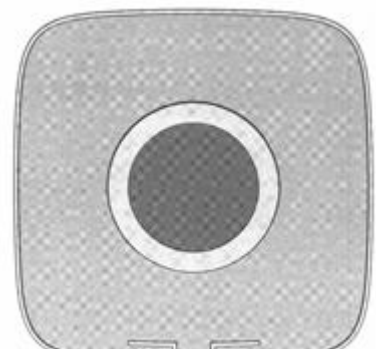

4.3

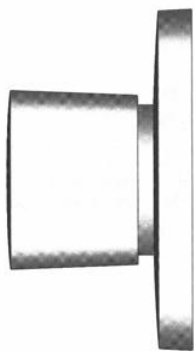

4.4

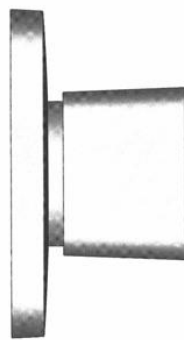

4.5



4.6

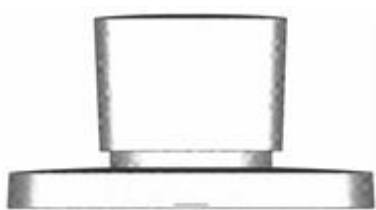

4.7



5.1

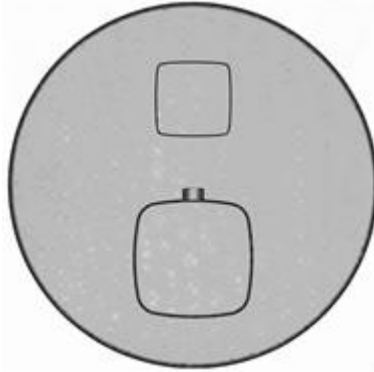

5.2



5.3

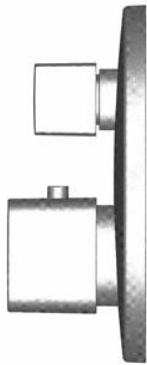

5.4

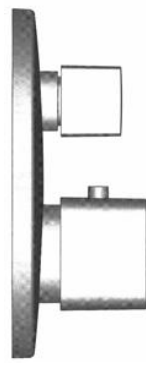

5.5



5.6



5.7



6.1



6.2



6.3

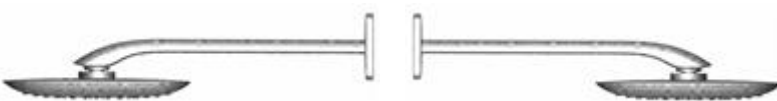

6.4



6.5

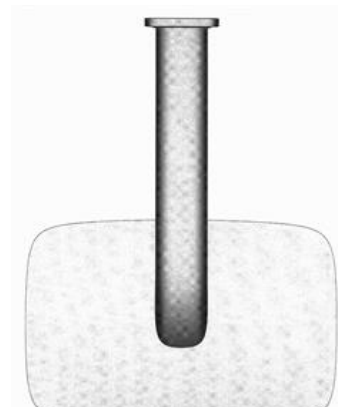

6.6

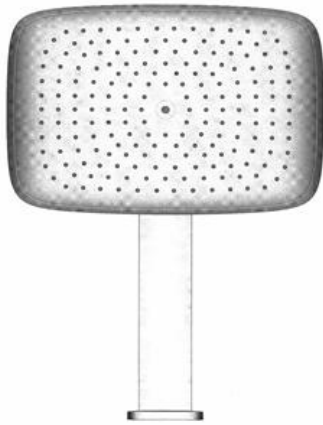

6.7



7.1



7.2



7.3

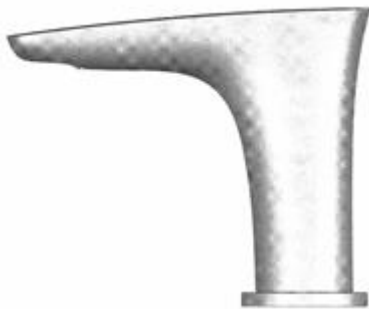

7.4

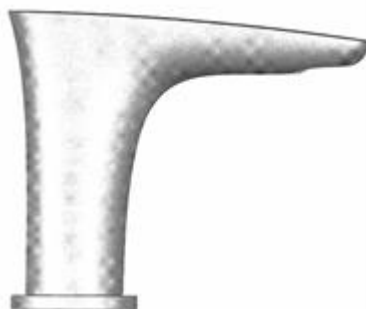

7.5



7.6



7.7



8.1



8.2

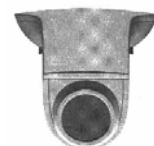

8.3



8.4

8.5



8.6



8.7

- (74) **Fullmektig:** Zacco Norway AS, Postboks 2003 Vikja, 0125 OSLO, NO
 (54) **Produkt:** 1-5. Sanitærarmatur
 6. Sanitærdusj
 7. Sanitærarmatur
 8. Sanitærdusj
 (51) **Klasse:** 1-8. 23-02
 (73) **Innehaver:** Hansgrohe AG, Auestrasse 5-9, 77761 SCHILTACH, DE
 (72) **Designer:** Sven Feustel, Breitscheidstrasse 9, 70176 STUTTGART, DE
 Tom Schonherr, Argonnenstr. 22, 70374 STUTTGART, DE
 (30) **Prioritet:** 2008.09.26 EM 001011415
 (60) **Anmerkning:** Registreringen gjelder samregistrering.

- (11) **Reg.nr.:** 081891
 (21) **Søkn.nr.:** 20090149
 (22) **Inngitt:** 2009.03.19
 (43) **Allm. tilgj.:** 2009.08.18
 (15) **Registrert:** 2009.08.18
 (45) **Kunngjort:** 2009.09.07
 (18) **Reg. gjelder til:** 2014.03.19
 (55) **Avbildning(er):**



1.1

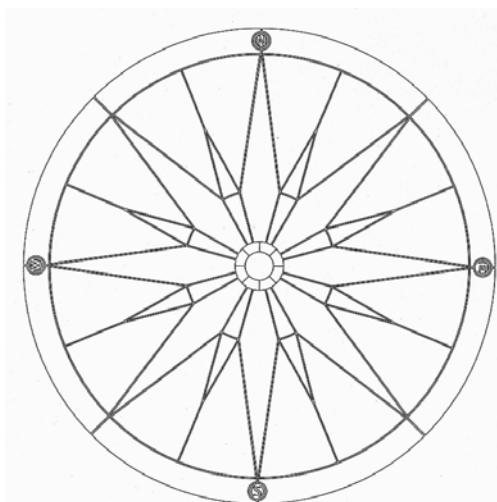

2.1

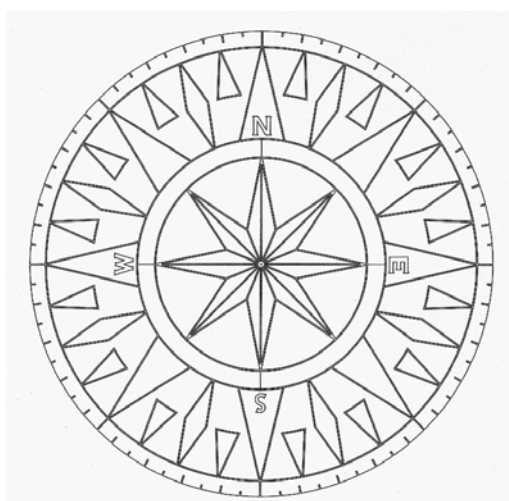

3.1

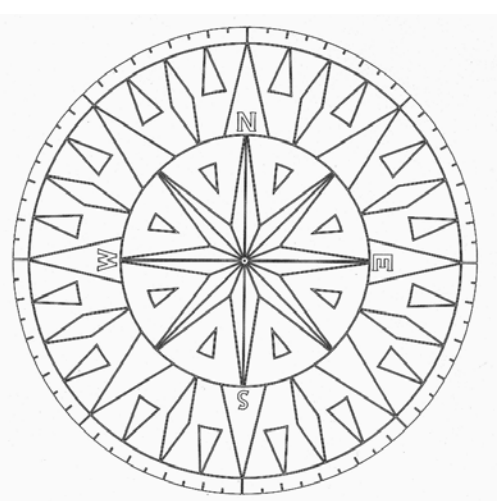

4.1

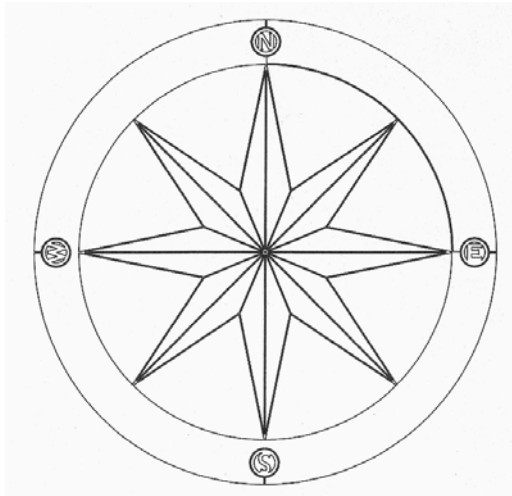

5.1

- (54) **Produkt:** 1-5. Ornamnt
(51) **Klasse:** 1-5. 32-00
(73) **Innehaver:** Nerland Dekor, 6095 BØLANDET, NO
(72) **Designer:** Frank-Roe Nerland, 6095 BØLANDET, NO
(60) **Anmerkning:** Registreringen gjelder samregistrering.
-

(11)	Reg.nr.:	081892
(21)	Søkn.nr.:	20080133
(22)	Inngitt:	2008.02.25
(43)	Allm. tilgj.:	2008.08.25
(15)	Registrert:	2009.08.18
(45)	Kunngjort:	2009.09.07
(18)	Reg. gjelder til:	2013.02.25
(55)	Avbildning(er):	

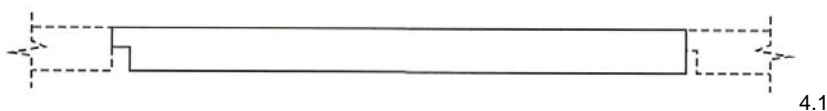
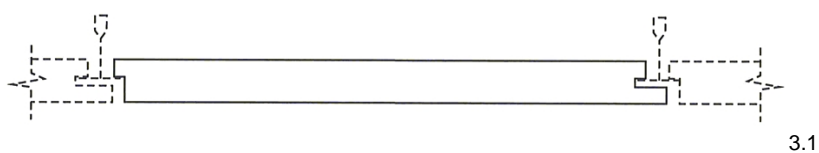
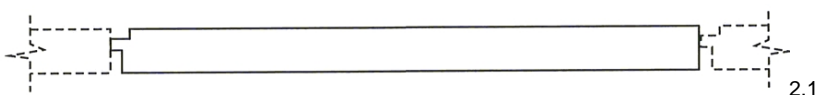
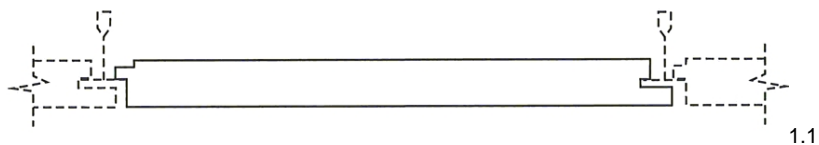

(74)	Fullmektig:	Protector Intellectual Property Consultants AS, Postboks 5074 Majorstua, 0301 OSLO, NO
(54)	Produkt:	1-6. Takpanel
(51)	Klasse:	1-6. 25-01, 25-02
(73)	Innehaver:	Rockwool International A/S, Hovedgaden 584, Indgang C, 2640 HEDEHUSENE, DK
(72)	Designer:	Nils Andersen, Stokholsvej 17, 3060 ESPERGÆRDE, DK
(60)	Anmerkning:	Registreringen gjelder samregistrering.

(11) **Reg.nr.:** 081893
(21) **Søkn.nr.:** 20090109
(22) **Inngitt:** 2009.03.03
(43) **Allm. tilgj.:** 2009.08.10
(15) **Registrert:** 2009.08.18
(45) **Kunngjort:** 2009.09.07
(18) **Reg. gjelder til:** 2014.03.03
(55) **Avbildning(er):**



(74) **Fullmektig:** Trond Bechmann, Wergelandsvegen 38 C, 7500 STJØRDAL, NO
(54) **Produkt:** Bluse med fastsydd BH
(51) **Klasse:** 02-01, 02-02
(73) **Innehaver:** Sheila Nakabiito Venvik, Skogmusvegen 26 F, 7082 KATTEM, NO
(72) **Designer:** Sheila Nakabiito Venvik, Skogmusvegen 26 F, 7082 KATTEM, NO
(30) **Prioritet:** 2009.02.10 UG 2009/000/316
(60) **Anmerkning:** Det er foretatt supplerende undersøkelse.

(11) **Reg.nr.:** 081894
(21) **Søkn.nr.:** 20090067
(22) **Inngitt:** 2009.02.05
(43) **Allm. tilgj.:** 2009.02.08
(15) **Registrert:** 2009.08.18
(45) **Kunngjort:** 2009.09.07
(18) **Reg. gjelder til:** 2014.02.05
(55) **Avbildning(er):**

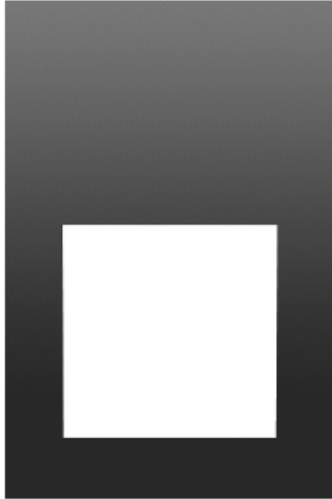

1.1

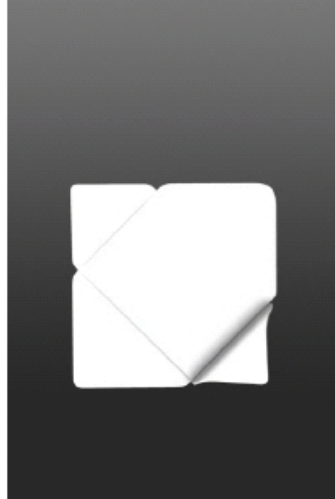

2.1



3.1

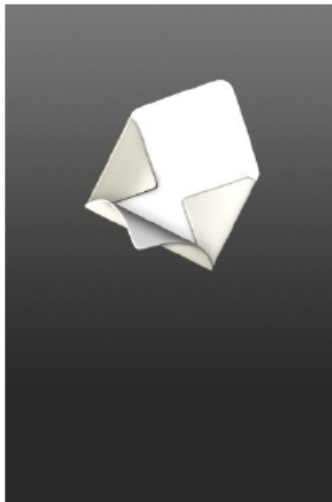

4.1

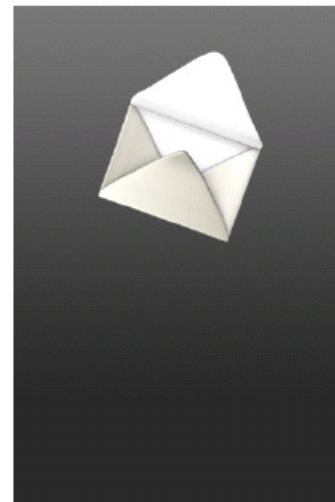

5.1

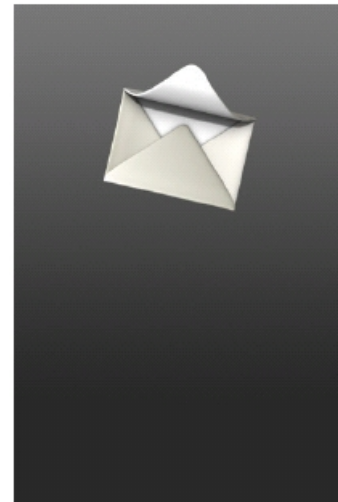

6.1

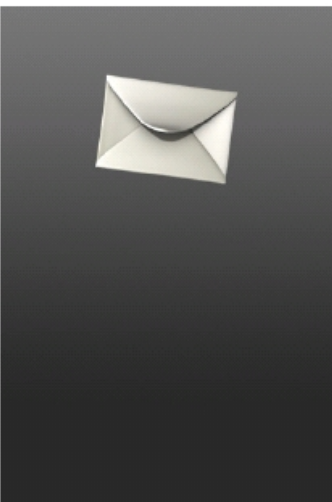

7.1

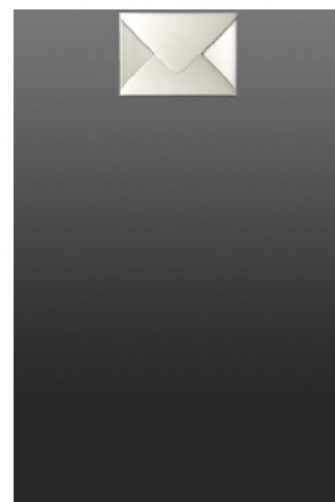

8.1

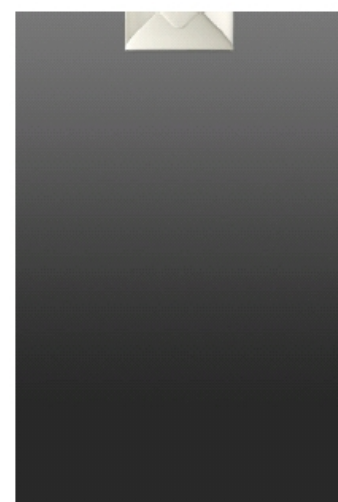

9.1

(74)	Fullmektig:	Zacco Norway AS, Postboks 2003 Vika, 0125 OSLO, NO
(54)	Produkt:	1-9. Ikon
(51)	Klasse:	1-9. 14-04
(73)	Innehaver:	Deutsche Telekom AG, Friedrich-Ebert-Allee 140, 53113 BONN, DE
(72)	Designer:	Deutsche Telekom AG, Friedrich-Ebert-Allee 140, 53113 BONN, DE
(30)	Prioritet:	2008.08.08 EM 000984885 (Design nr. 5) 2009.01.09 EM 001068001 (Design nr. 1-4, 6-9)
(60)	Anmerkning:	Registreringen gjelder samregistrering.

(11)	Reg.nr.:	081895
(21)	Søkn.nr.:	20080643
(22)	Inngitt:	2008.11.21
(43)	Allm. tilgj.:	2008.11.23
(15)	Registrert:	2009.08.18
(45)	Kunngjort:	2009.09.07
(18)	Reg. gjelder til:	2013.11.21
(55)	Avbildning(er):	

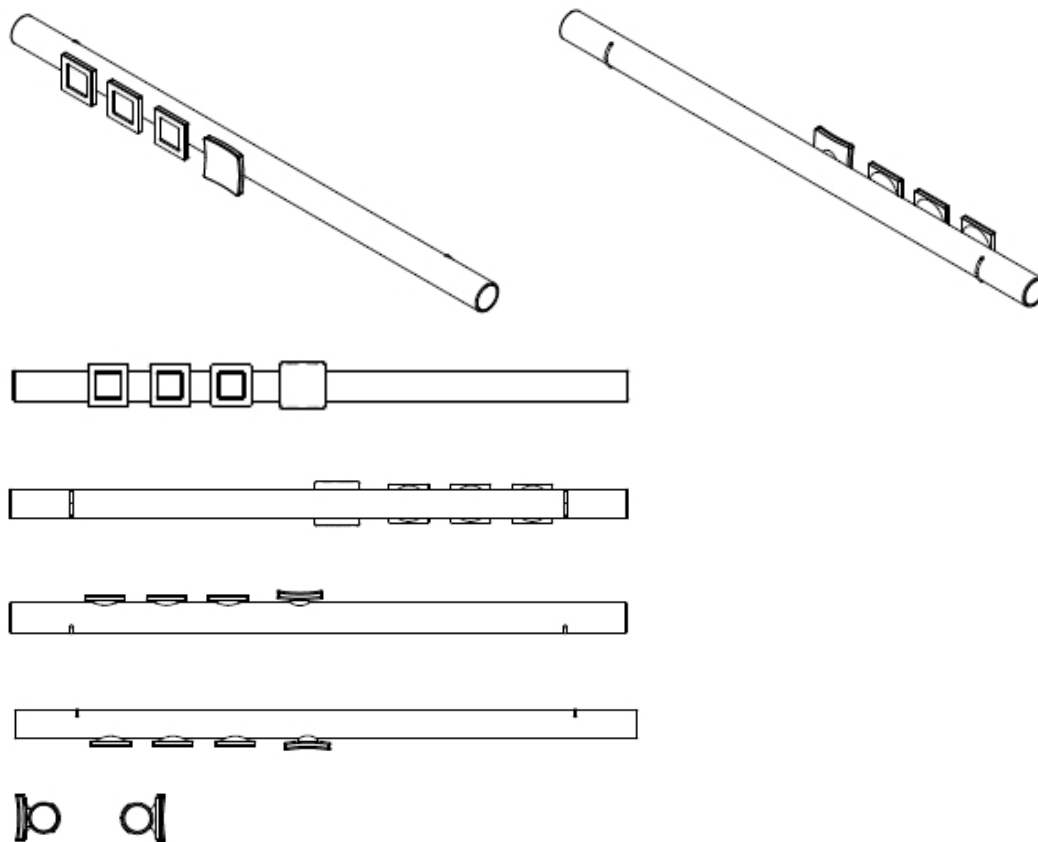

(74)	Fullmektig:	Oslo Patentkontor AS, Postboks 7007 Majorstua, 0306 OSLO, NO
(54)	Produkt:	Elektronisk alarm med fjernstyringsfunksjon
(51)	Klasse:	10-05, 14-03
(73)	Innehaver:	Bang & Olufsen A/S, Peter Bangs Vej 15, 7600 STRUER, DK
(72)	Designer:	Steffen Schmelling, Søllerødgade 39, 1.th, 2200 KØBENHAVN N, DK
(30)	Prioritet:	2008.05.23 DK 2008 00138

(11)	Reg.nr.:	081896
(21)	Søkn.nr.:	20090128
(22)	Inngitt:	2009.03.12
(43)	Allm. tilgj.:	2009.06.16
(15)	Registrert:	2009.08.18
(45)	Kunngjort:	2009.09.07
(18)	Reg. gjelder til:	2014.03.12
(55)	Avbildning(er):	

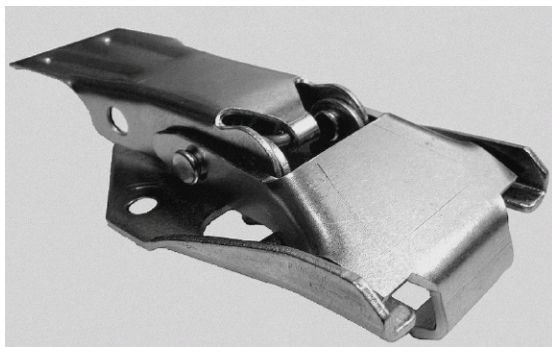
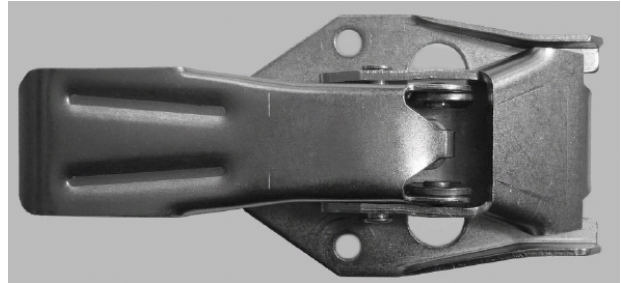

(74)	Fullmektig:	Håmsø Patentbyrå ANS, Postboks 171, 4302 SANDNES, NO
(54)	Produkt:	Låseanordning
(51)	Klasse:	08-07
(73)	Innehaver:	HTK Transportkonstruksjoner AB, Skrugatan 2, 55302 JÖNKÖPING, SE
(72)	Designer:	Weimar Nilsson, Stora Karsnäs 2, 56192 HUSKVARNA, SE
(30)	Prioritet:	2008.12.16 EM 001058028

(11)	Reg.nr.:	081897
(21)	Søkn.nr.:	20090063
(22)	Inngitt:	2009.02.04
(43)	Allm. tilgj.:	2009.08.04
(15)	Registrert:	2009.08.18
(45)	Kunngjort:	2009.09.07
(18)	Reg. gjelder til:	2014.02.04
(55)	Avbildning(er):	



1.1

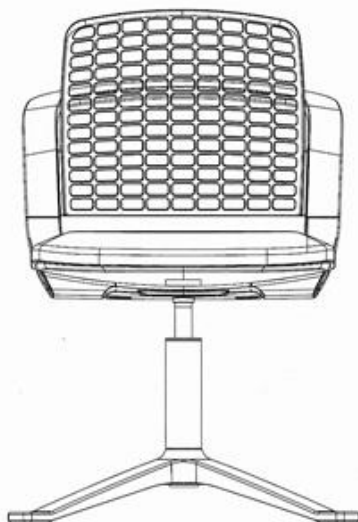

1.2



1.3



1.4

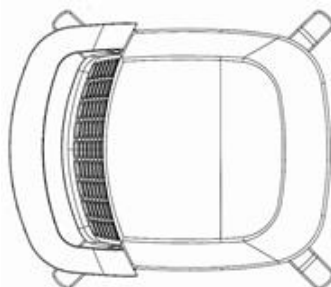

1.5

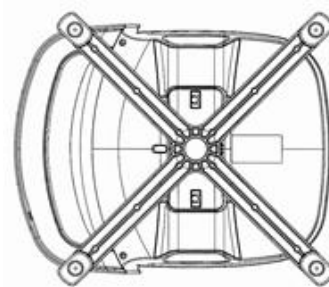

1.6



2.1



2.2



2.3



2.4

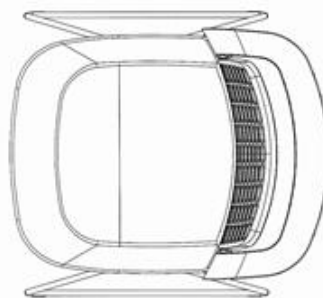

2.5

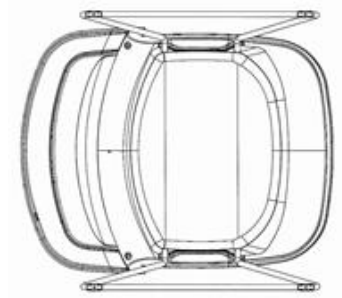

2.6



3.1



3.2

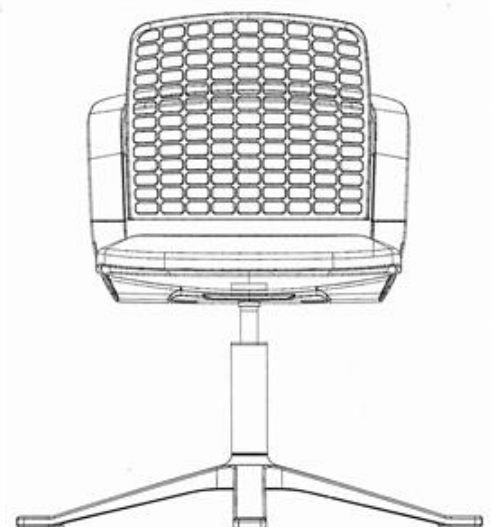

3.3

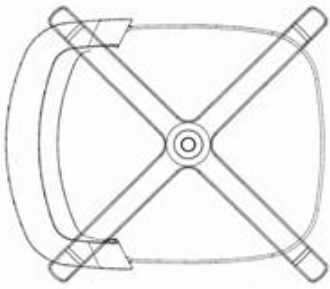

3.4

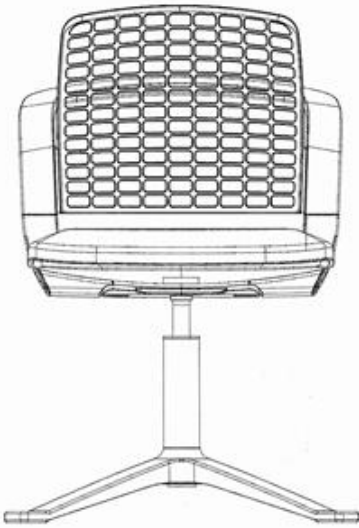

4.1

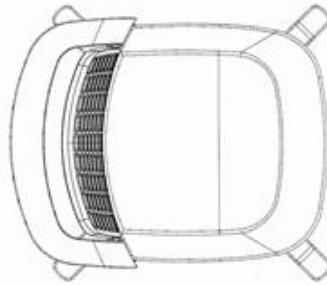

4.2



5.1

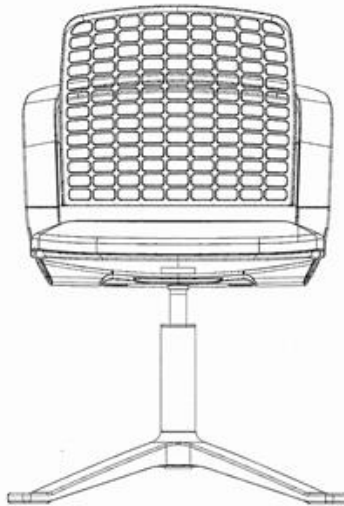

5.2



5.3

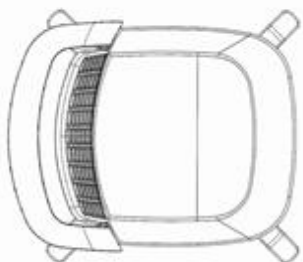

5.4



6.1

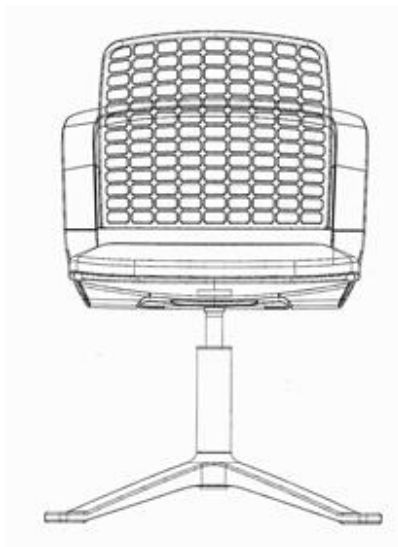

6.2



6.3



6.4

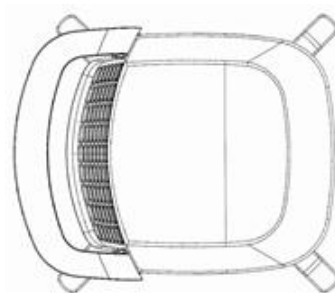

6.5



7.1

- (74) **Fullmektig:** Zacco Norway AS, Postboks 2003 Vika, 0125 OSLO, NO
(54) **Produkt:** 1-2. Stol
3-6. Del av stol
7. Stol
(51) **Klasse:** 1-7. 06-01
(73) **Innehaver:** Håg AS, Postboks 5055 Majorstua, 0301 OSLO, NO
(72) **Designert:** Sigbjørn Windingstad, Dannevigsgveien 12, 0463 OSLO, NO
Geir Eide, Brannfjellveien 102B, 1182 OSLO, NO
Aleksander Borgenhov, Hellinga 2D, 1151 OSLO, NO
(60) **Anmerkning:** Registreringen gjelder samregistrering.
-

- (11) **Reg.nr.:** 081898
(21) **Søkn.nr.:** 20090150
(22) **Inngitt:** 2009.03.23
(43) **Allm. tilgj.:** 2009.08.19
(15) **Registrert:** 2009.08.19
(45) **Kunngjort:** 2009.09.07
(18) **Reg. gjelder til:** 2014.03.23
(55) **Avbildning(er):**

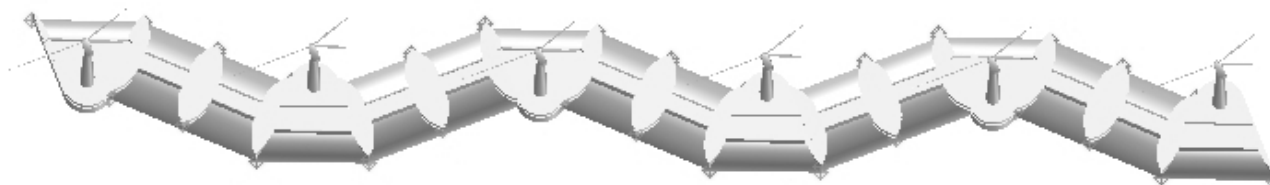
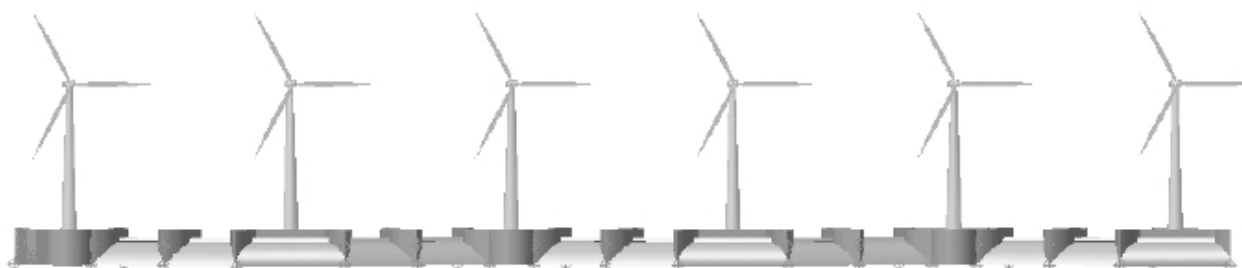
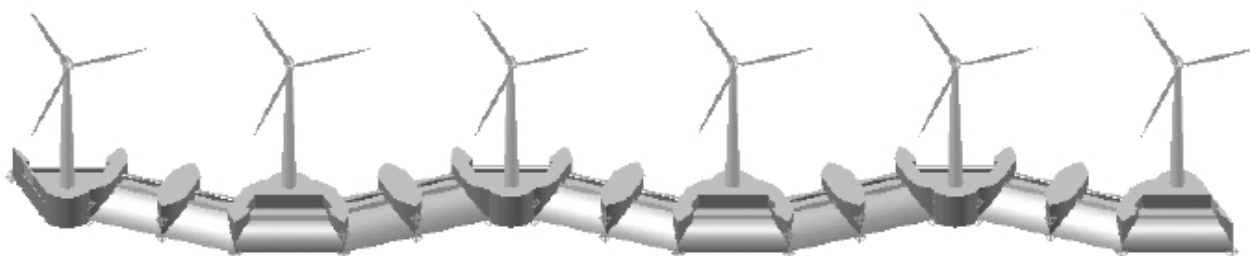

- (54) **Produkt:** Hybrid bølge- og vindkraftverk
(51) **Klasse:** 25-03
(73) **Innehaver:** Ånund Ottesen, Sundgot, 6065 ULSTEINVIK, NO
(72) **Designert:** Ånund Ottesen, Boks 198, 6067 ULSTEINVIK, NO
-

(11)	Reg.nr.:	081899
(21)	Søkn.nr.:	20090076
(22)	Inngitt:	2009.02.10
(43)	Allm. tilgj.:	2009.03.09
(15)	Registrert:	2009.08.19
(45)	Kunngjort:	2009.09.07
(18)	Reg. gjelder til:	2014.02.10
(55)	Avbildning(er):	



1.1



1.2



1.3



1.4



1.5



1.6



1.7



2.1



2.2



2.3



2.4



2.5



2.6



2.7

- (74) **Fullmektig:** Bryn Aarflot AS, Postboks 449 Sentrum, 0104 OSLO, NO
 (54) **Produkt:** 1-2. Beskyttelsesklær mot røntgenstråler
 (51) **Klasse:** 1-2. 02-02
 (73) **Innehaver:** Mavig GmbH, Stahlgruberring 5, 81829 MÜNCHEN, DE
 (72) **Designer:** Mavig GmbH, Stahlgruberring 5, 81829 MÜNCHEN, DE
 (30) **Prioritet:** 2008.09.09 EM 001004550
 (60) **Anmerkning:** Registreringen gjelder samregistrering.

(11)	Reg.nr.:	081900
(21)	Søkn.nr.:	20090181
(22)	Inngitt:	2009.04.03
(43)	Allm. tilgj.:	2009.05.13
(15)	Registrert:	2009.08.19
(45)	Kunngjort:	2009.09.07
(18)	Reg. gjelder til:	2014.04.03
(55)	Avbildning(er):	

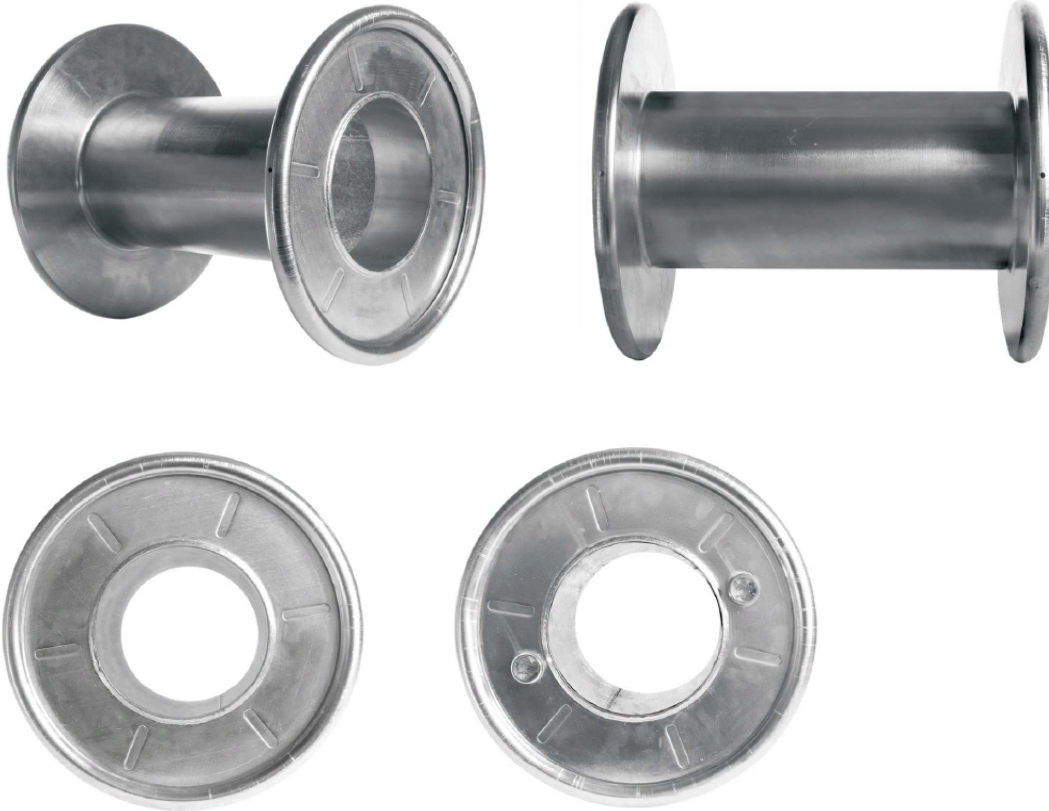

(74)	Fullmektig:	Bryn Aarflot AS, Postboks 449 Sentrum, 0104 OSLO, NO
(54)	Produkt:	Snelle
(51)	Klasse:	15-06
(73)	Innehaver:	NV Bekaert SA, Bekaertstraat 2, 8550 ZWEVEGEM, BE
(72)	Designer:	Luc Pauwels, Krakeelhoek 12, 9950 WAARSCHOOT, BE
(30)	Prioritet:	2008.11.13 EM 468867701

- (11) **Reg.nr.:** 081901
- (21) **Søkn.nr.:** 20080624
- (22) **Inngitt:** 2008.11.18
- (43) **Allm. tilgj.:** 2008.11.19
- (15) **Registrert:** 2009.08.19
- (45) **Kunngjort:** 2009.09.07
- (18) **Reg. gjelder til:** 2013.11.18
- (55) **Avbildning(er):**

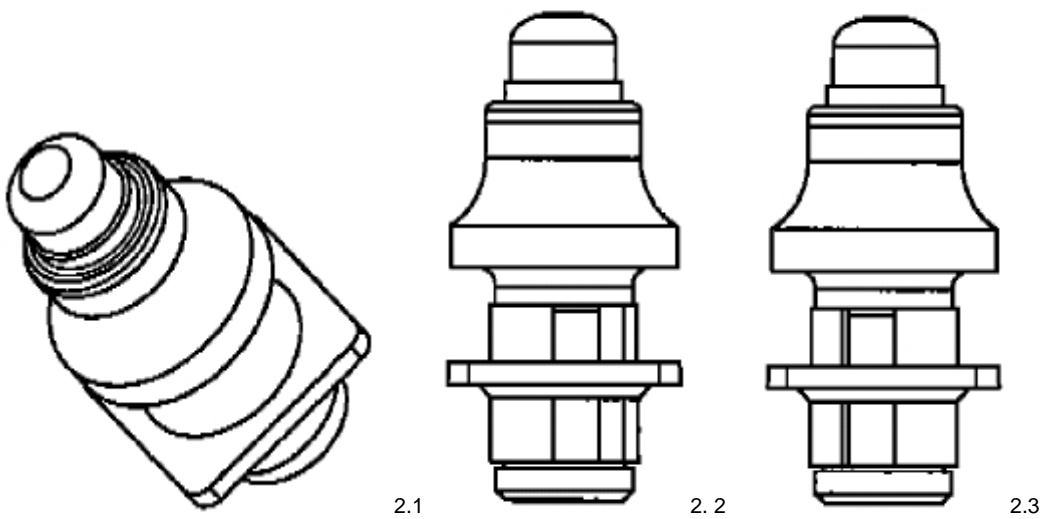
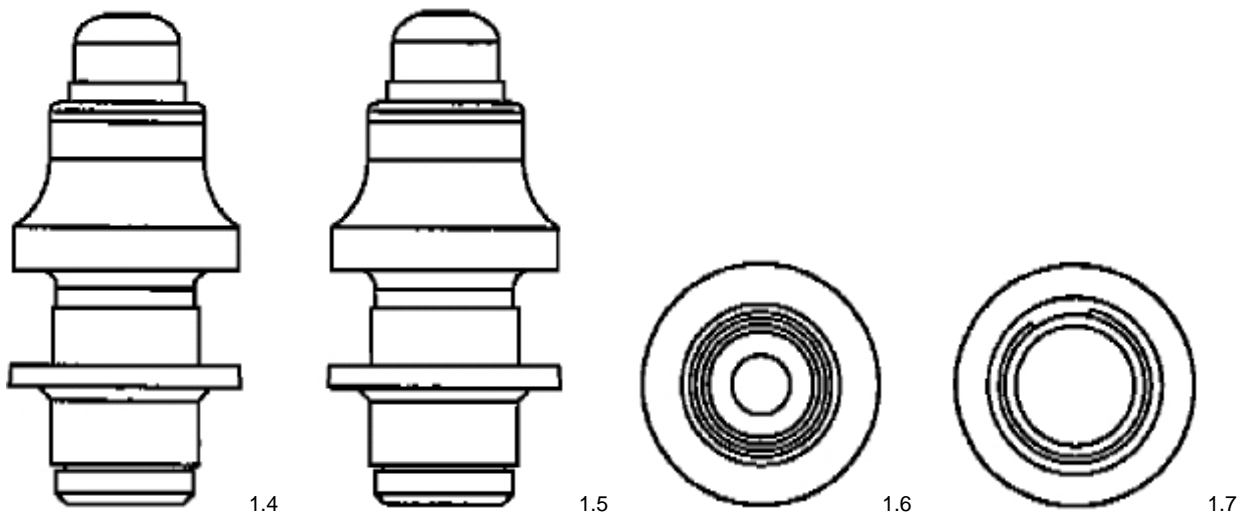
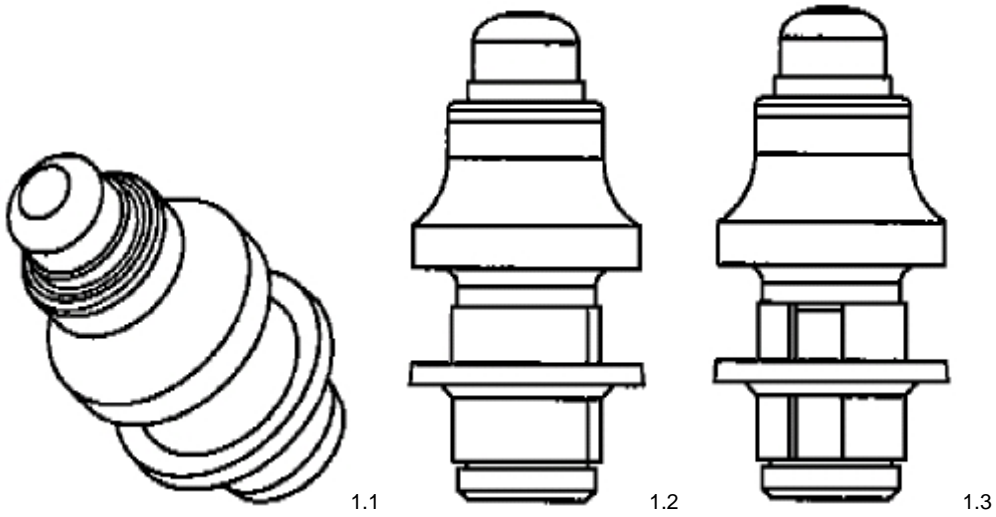

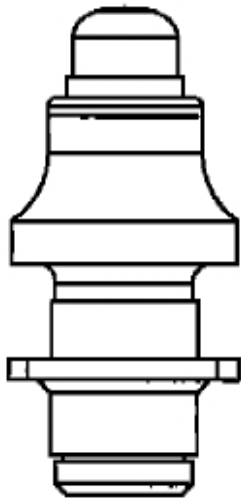

2.4

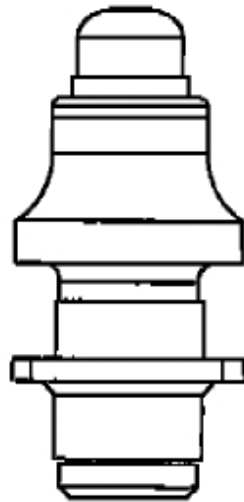

2.5

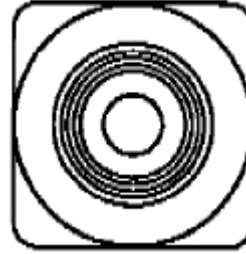

2.6

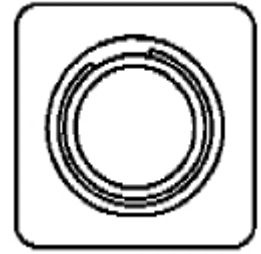

2.7

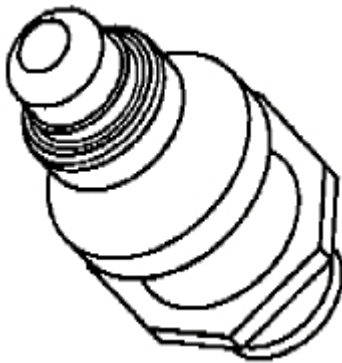

3.1

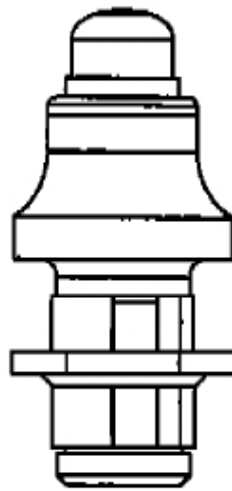

3.2



3.3

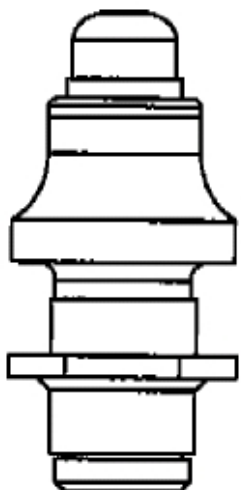

3.4

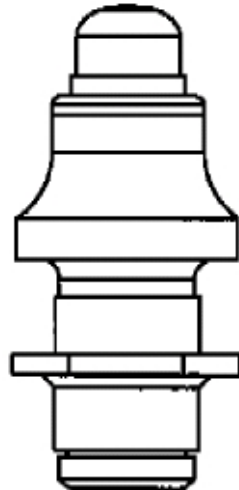

3.5



3.6



3.7

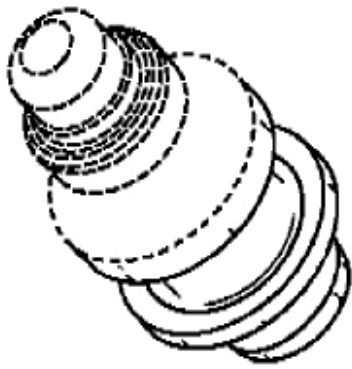

4.1

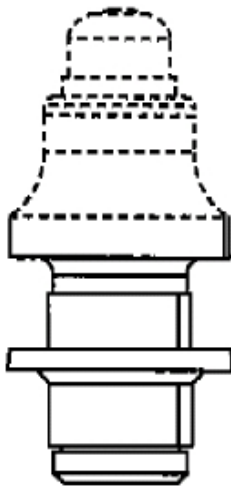

4.2

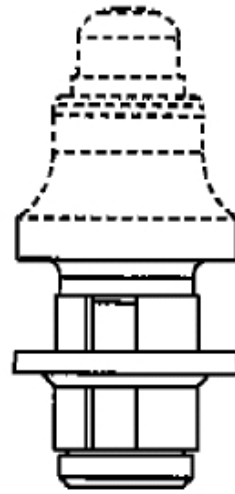

4.3

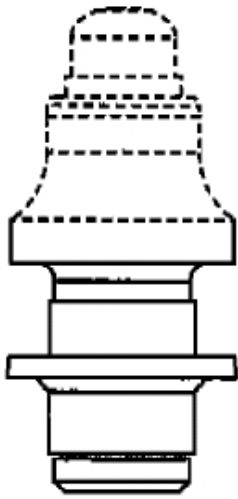

4.4

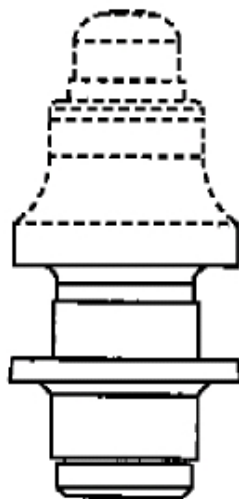

4.5

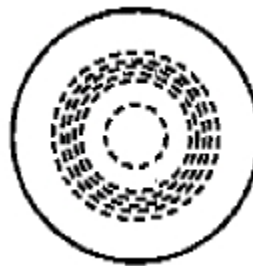

4.6

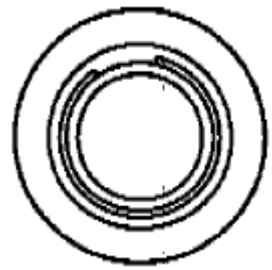

4.7

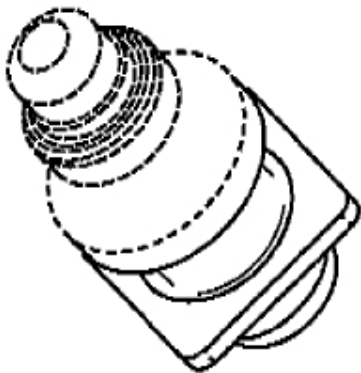

5.1

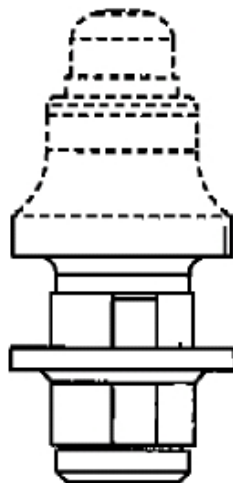

5.2

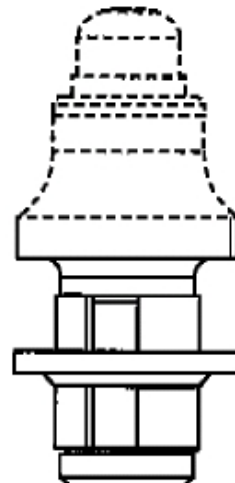

5.3

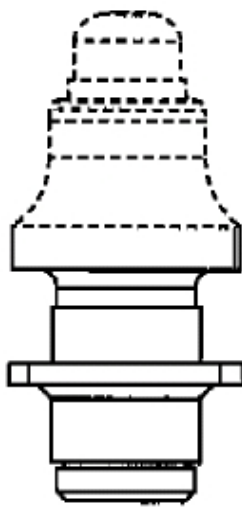

5.4

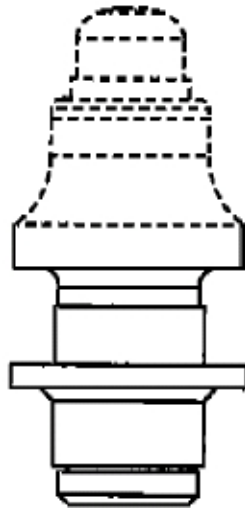

5.5

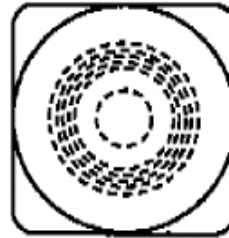

5.6

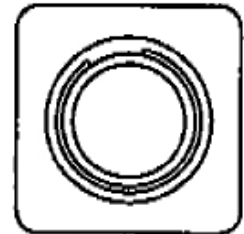

5.7

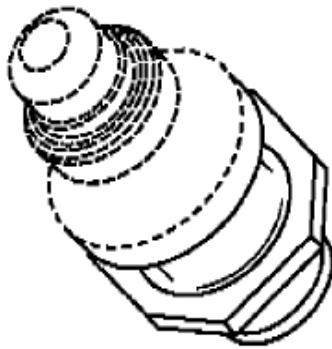

6.1

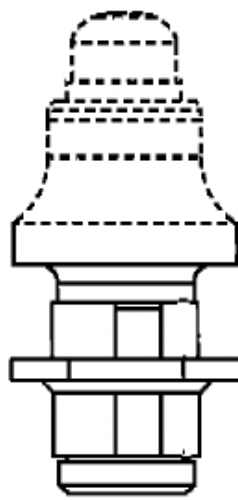

6.2

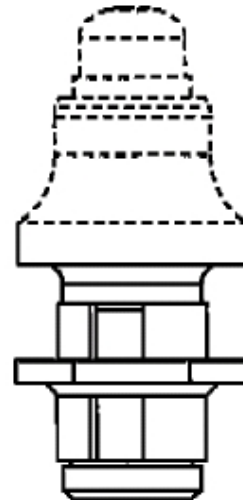

6.3

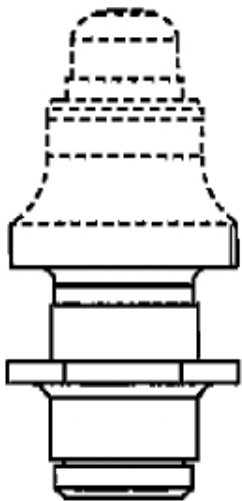

6.4

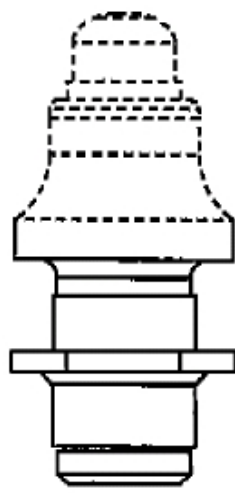

6.5

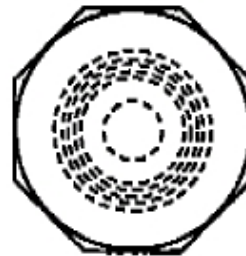

6.6



6.7

- (74) **Fullmektig:** Bryn Aarflot AS, Postboks 449 Sentrum, 0104 OSLO, NO
- (54) **Produkt:** 1-3. Selvrotterende hardmetallpigg for høvelskjær
4-6. Del av selvrotterende hardmetallpigg for høvelskjær
- (51) **Klasse:** 1-6. 12-16
- (73) **Innehaver:** Sandvik Intellectual Property AB, 81181 SANDVIKEN, SE
- (72) **Designer:** Joseph Fader, 135 Smartview Lane, VA24210 ABINGDON, US
Kenneth Monyak, 17270 Mary Lee Drive, VA24210 ABINGDON, US
2008.05.19 US 29/318,344
- (30) **Prioritet:**
- (60) **Anmerkning:** Registreringen gjelder samregistrering.

(11)	Reg.nr.:	081902
(21)	Søkn.nr.:	20090102
(22)	Inngitt:	2009.02.27
(43)	Allm. tilgj.:	2009.02.28
(15)	Registrert:	2009.08.20
(45)	Kunngjort:	2009.09.07
(18)	Reg. gjelder til:	2014.02.27
(55)	Avbildning(er):	



1.1



1.2



1.3



1.4



1.5



1.6

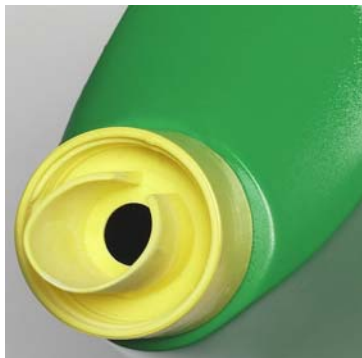

2.1



2.2



3.1



4.1



4.2



4.3



4.4



4.5



4.6

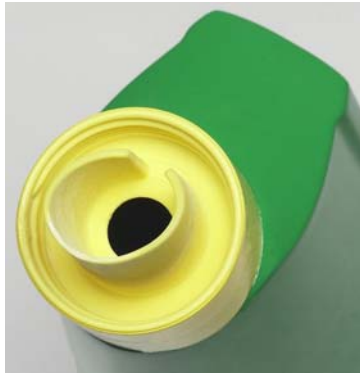

5.1



5.2



6.1

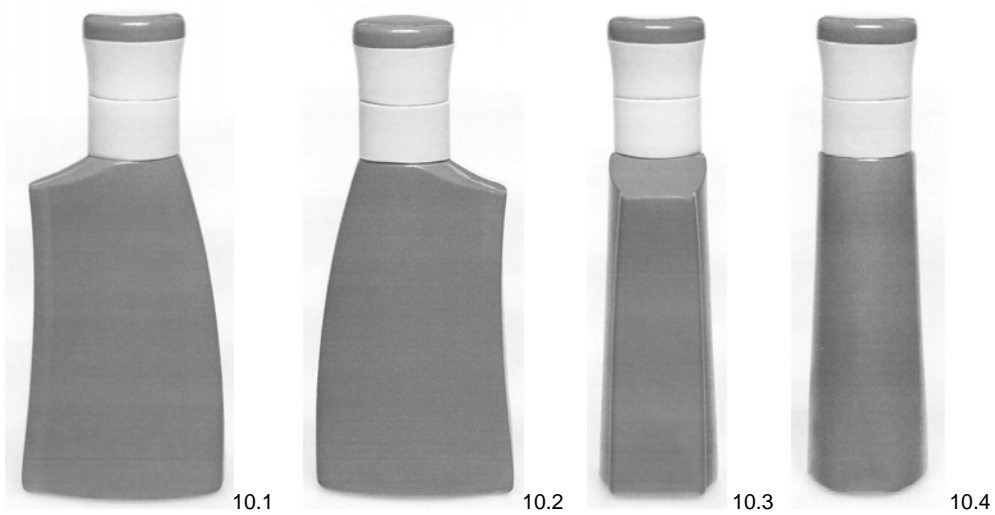
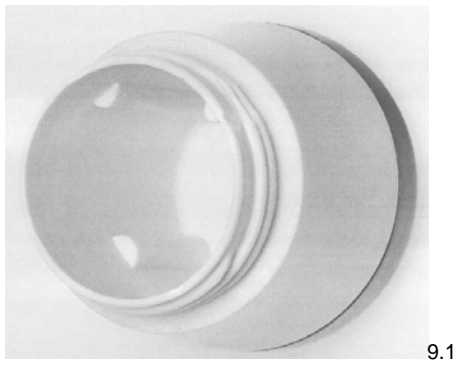
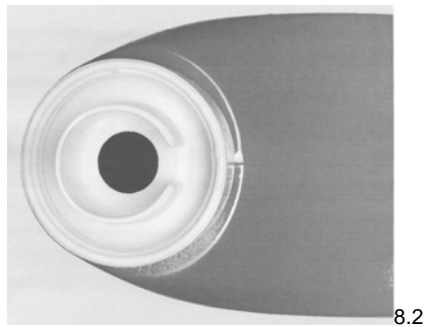
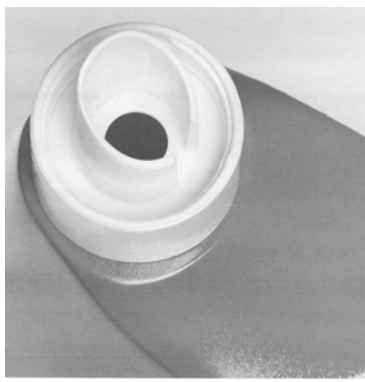
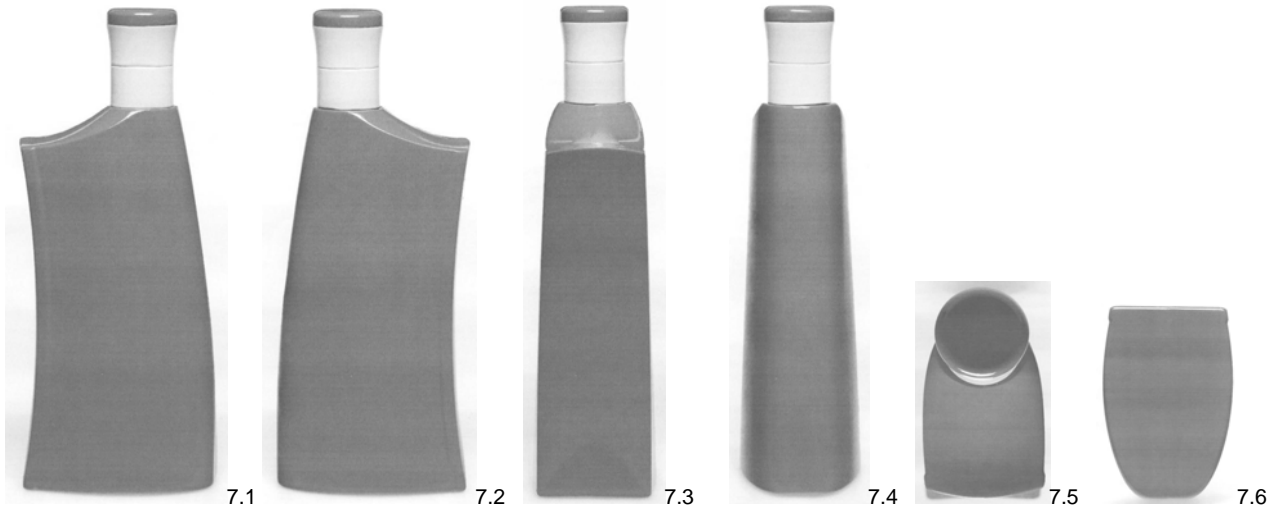

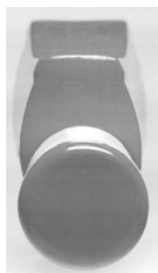

10.5



10.6

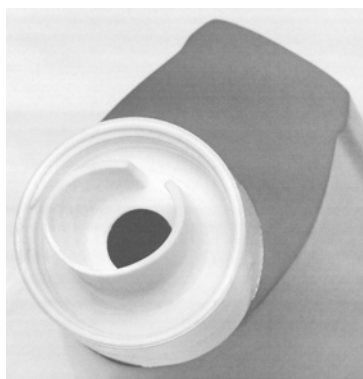

11.1

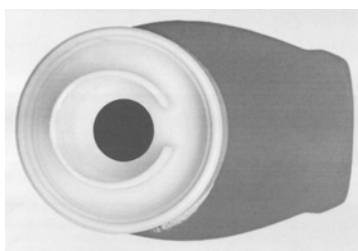

11.2

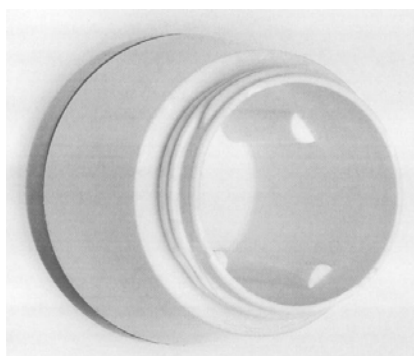

12.1

- (74) **Fullmektig:** Protector Intellectual Property Consultants AS, Postboks 5074 Majorstuen, 0301 OSLO, NO
- (54) **Produkt:**
1. Flaske
 2. Del av flaske
 3. Kork til flaske
 4. Flaske
 5. Del av flaske
 6. Kork til flaske
 7. Flaske
 8. Del av flaske
 9. Kork til flaske
 10. Flaske
 11. Del av flaske
 12. Kork til flaske
- (51) **Klasse:**
- 1-2. 09-01
 3. 09-07
 - 4-5. 09-01
 6. 09-07
 - 7-8. 09-01
 9. 09-07
 - 10-11. 09-01
 12. 09-07
- (73) **Innehaver:** W Neudorff GmbH KG, An der Mühle 3, 31860 EMMERTHAL, DE
- (72) **Designer:** Volker Hundertmark, Jenhorst 54, 3164 Raddestorf, DE
- (30) **Prioritet:** 2008.08.28 EM 000993373
- (60) **Anmerkning:** Design nr. 1 -6 er i farger.
Registreringen gjelder samregistrering.

(11) **Reg.nr.:** 081903
(21) **Søkn.nr.:** 20080516
(22) **Inngitt:** 2008.09.25
(43) **Allm. tilgj.:** 2008.09.27
(15) **Registrert:** 2009.08.20
(45) **Kunngjort:** 2009.09.07
(18) **Reg. gjelder til:** 2013.09.25
(55) **Avbildning(er):**

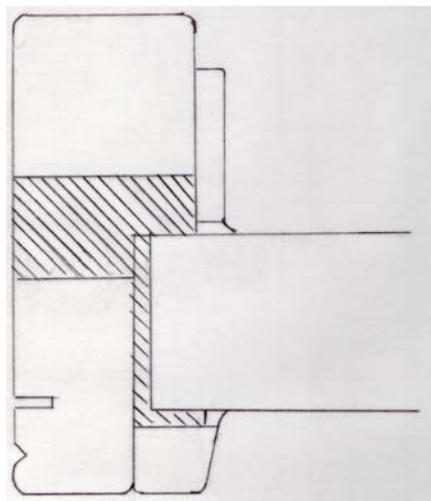

1.1

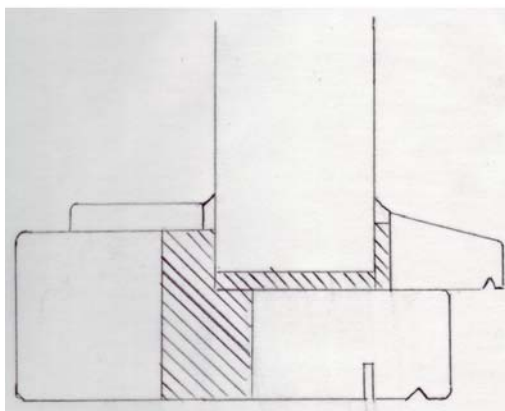

2.1

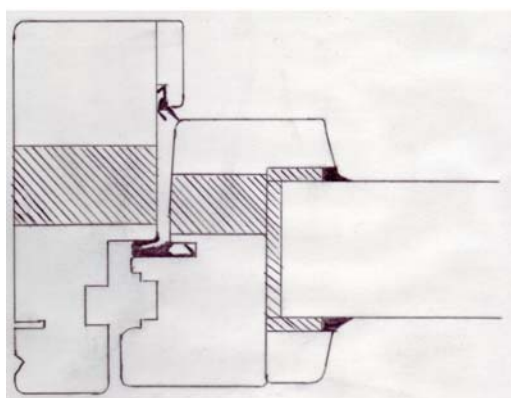

3.1

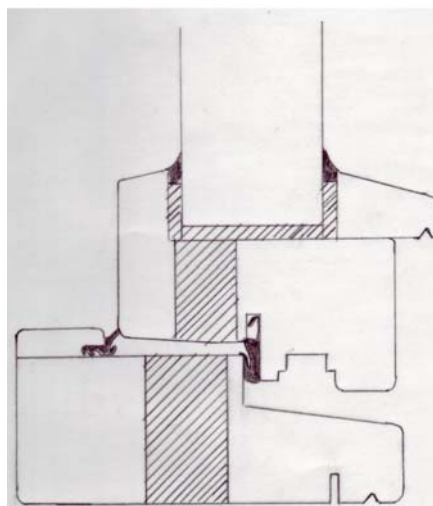

4.1

(74) **Fullmektig:** Oslo Patentkontor AS, Postboks 7007 Majorstua, 0306 OSLO, NO
(54) **Produkt:** 1-4. Profilert vinduskarm med del av glassrute
(51) **Klasse:** 1-4. 25-01
(73) **Innehaver:** TopTræ Holding APS, c/o Karin Borg Agerøvej 18 V Hvidbjerg, 7960 KARBY, DK
(72) **Designer:** Finn Borg, Agerøvej 18, 7960 KARBY, DK
(30) **Prioritet:** 2008.03.27 EM 000904230
(60) **Anmerkning:** Registreringen gjelder samregistrering.

- (11) **Reg.nr.:** 081904
(21) **Søkn.nr.:** 20090194
(22) **Inngitt:** 2009.04.15
(43) **Allm. tilgj.:** 2009.05.06
(15) **Registrert:** 2009.08.20
(45) **Kunngjort:** 2009.09.07
(18) **Reg. gjelder til:** 2014.04.15
(55) **Avbildning(er):**

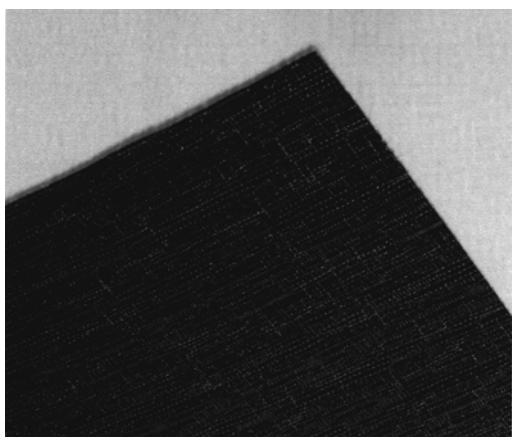
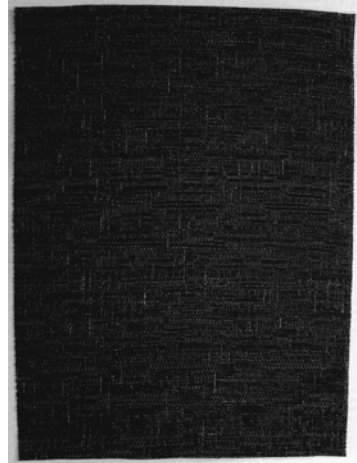
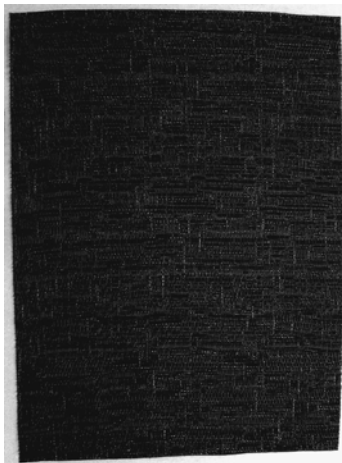
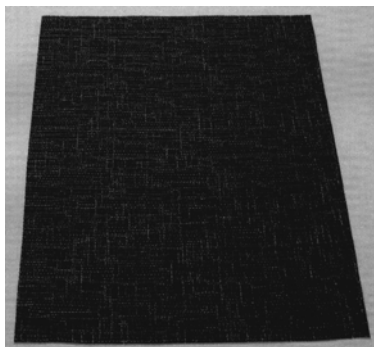
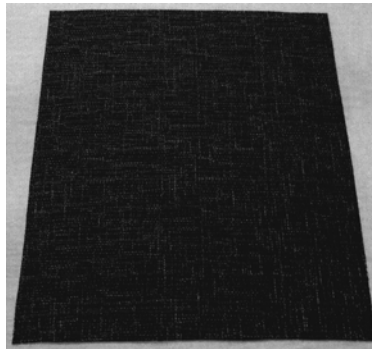
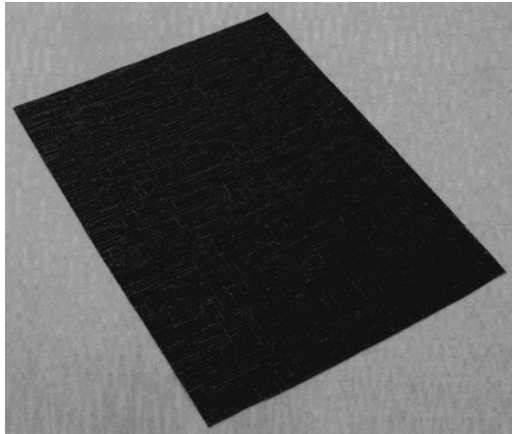

Detaljutsnitt



Detaljutsnitt

- (74) **Fullmektig:** Bryn Aarflot AS, Postboks 449 Sentrum, 0104 OSLO, NO
(54) **Produkt:** Vevd tøy/stoff
(51) **Klasse:** 05-05
(73) **Innehaver:** Chilewich Sultan LLC, 44 East 32nd Street, NY10016 NEW YORK, US
(72) **Designer:** Sandra Chilewich, 44 East 32nd Street, NY10016 NEW YORK, US

(11)	Reg.nr.:	081905
(21)	Søkn.nr.:	20090195
(22)	Inngitt:	2009.04.15
(43)	Allm. tilgj.:	2009.05.06
(15)	Registrert:	2009.08.20
(45)	Kunngjort:	2009.09.07
(18)	Reg. gjelder til:	2014.04.15
(55)	Avbildning(er):	

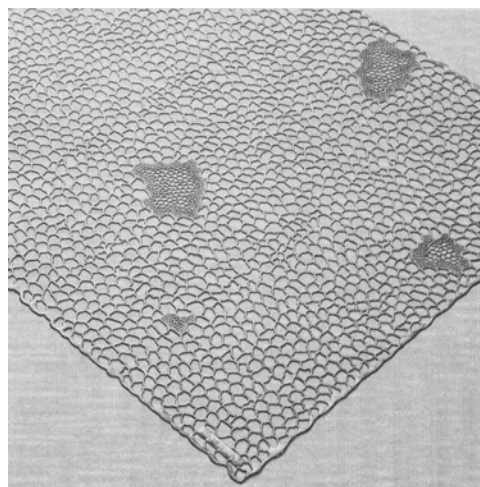
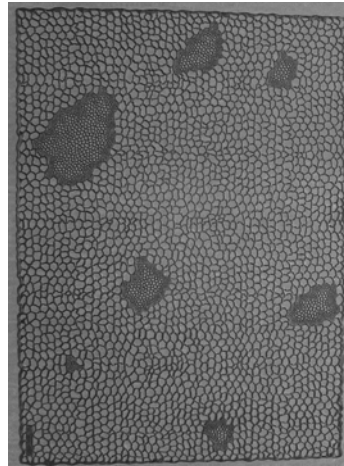
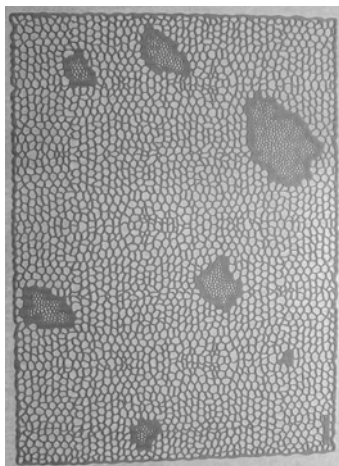
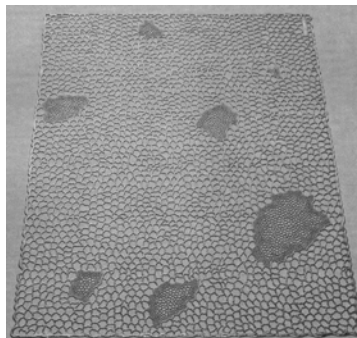
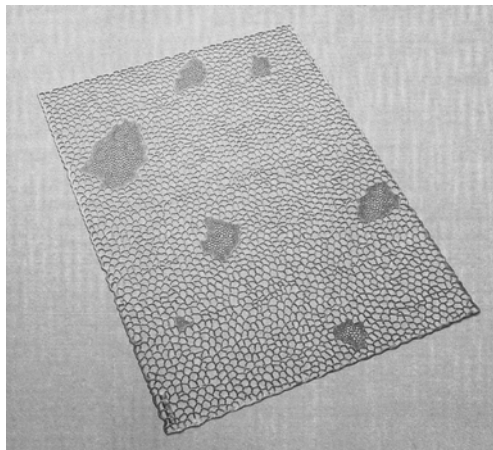

Detaljutsnitt

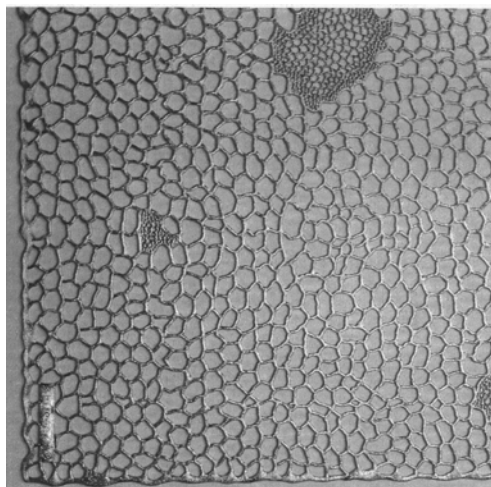

Detaljutsnitt

(74)	Fullmektig:	Bryn Aarflot AS, Postboks 449 Sentrum, 0104 OSLO, NO
(54)	Produkt:	Vevd tøy/stoff
(51)	Klasse:	05-05
(73)	Innehaver:	Chilewich Sultan LLC, 44 East 32nd Street, NY10016 NEW YORK, US
(72)	Designer:	Sandra Chilewich, 44 East 32nd Street, NY10016 NEW YORK, US

(11)	Reg.nr.:	081906
(21)	Søkn.nr.:	20090196
(22)	Inngitt:	2009.04.15
(43)	Allm. tilgj.:	2009.05.06
(15)	Registrert:	2009.08.20
(45)	Kunngjort:	2009.09.07
(18)	Reg. gjelder til:	2014.04.15
(55)	Avbildning(er):	

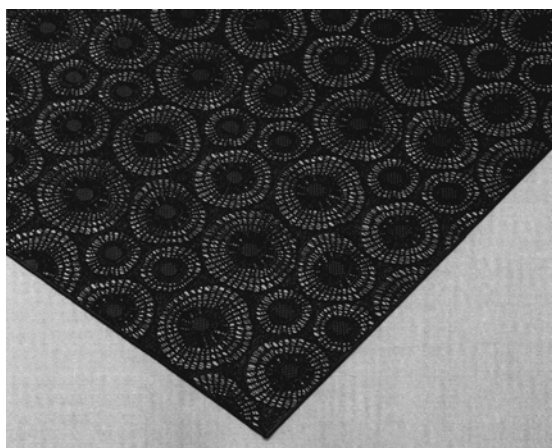
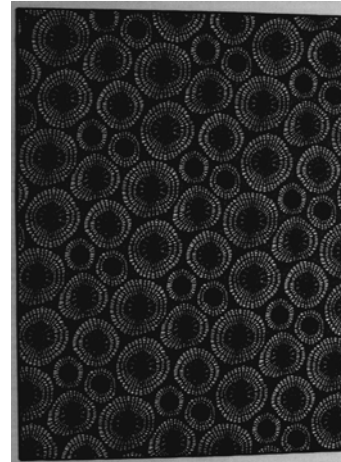
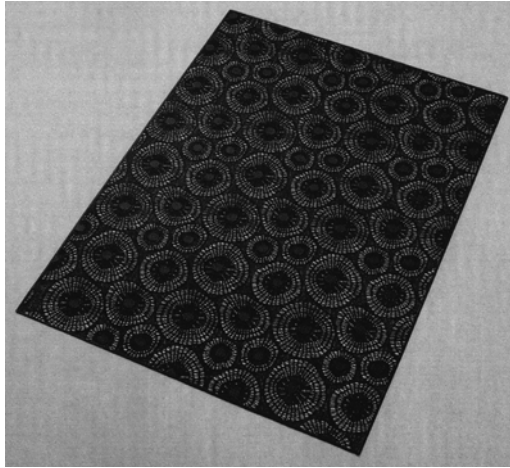

Detaljutsnitt

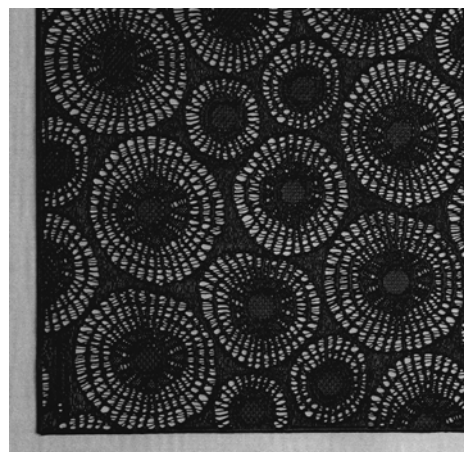

Detaljutsnitt

(74)	Fullmektig:	Bryn Aarflot AS, Postboks 449 Sentrum, 0104 OSLO, NO
(54)	Produkt:	Vevd tøy/stoff
(51)	Klasse:	05-05
(73)	Innehaver:	Chilewich Sultan LLC, 44 East 32nd Street, NY10016 NEW YORK, US
(72)	Designer:	Sandra Chilewich, 44 East 32nd Street, NY10016 NEW YORK, US

Fornyelse av registreringer

Reg.nr: 068414 Fornyhet til: 2014.08.24
Innehaver: Unilever NV, Burgermeester s'Jacobplein 1, 3015CA ROTTERDAM, NL
Fullmektig: Zacco Norway AS, Postboks 2003 Vika, 0125 OSLO, NO

Reg.nr: 068418 Fornyhet til: 2014.09.07
Innehaver: Unilever NV, Burgermeester s'Jacobplein 1, 3015CA ROTTERDAM, NL
Fullmektig: Zacco Norway AS, Postboks 2003 Vika, 0125 OSLO, NO

Reg.nr: 068469 Fornyhet til: 2014.09.07
Innehaver: Johnson & Johnson Consumer Products Inc, 501 George Street, NJ08903 NEW BRUNSWICK, US
Fullmektig: Zacco Norway AS, Postboks 2003 Vika, 0125 OSLO, NO

Reg.nr: 068615 Fornyhet til: 2014.09.05
Innehaver: Unilever NV, Burgermeester s'Jacobplein 1, 3015CA ROTTERDAM, NL
Fullmektig: Zacco Norway AS, Postboks 2003 Vika, 0125 OSLO, NO

Reg.nr: 068686 Fornyhet til: 2014.08.25
Innehaver: Steelform Scandinavia AB, Värendsgatan 30, 36030 LAMMHULT, SE
Fullmektig: Gotapatent AB, Box 3127, 55003 JÖNKÖPING, SE

Reg.nr: 072223 Fornyhet til: 2014.09.12
Innehaver: Beaute Prestige International SA, 28-32, avenue Victor Hugo, 75116 PARIS, FR
Fullmektig: Tandbergs Patentkontor AS, Postboks 7085 Majorstua, 0306 OSLO, NO

Reg.nr: 072332 Fornyhet til: 2014.09.12
Innehaver: Sonoco Products Co, 1 North Second Street, SC 29550-0160 HARTSVILLE, US
Fullmektig: Onsagers AS, Postboks 6963 St Olavs Plass, 0130 OSLO, NO

Reg.nr: 072544 Fornyhet til: 2014.08.22
Innehaver: Alustar AS, Joavn., 4050 SOLA, NO
Fullmektig: Håmsø Patentbyrå ANS, Postboks 171, 4302 SANDNES, NO

Reg.nr: 073592 Fornyhet til: 2014.02.10
Innehaver: Advanced Production and Loading AS, Vikaveien 85, 4816 KOLBJØRNSVIK, NO
Fullmektig: Tandbergs Patentkontor AS, Postboks 7085 Majorstua, 0306 OSLO, NO

Reg.nr: 073593 Fornyhet til: 2014.02.10
Innehaver: Advanced Production and Loading AS, Vikaveien 85, 4816 KOLBJØRNSVIK, NO
Fullmektig: Tandbergs Patentkontor AS, Postboks 7085 Majorstua, 0306 OSLO, NO

Reg.nr: 073594 Fornyhet til: 2014.02.10
Innehaver: Advanced Production and Loading AS, Vikaveien 85, 4816 KOLBJØRNSVIK, NO
Fullmektig: Tandbergs Patentkontor AS, Postboks 7085 Majorstua, 0306 OSLO, NO

Reg.nr: 075590 Fornyhet til: 2014.08.13
Innehaver: Gilson SAS, 19 ave des Entrepreneurs, zi Tissonvilliers BP 145, 95400 VILLIERS LE BEL, FR
Fullmektig: Onsagers AS, Postboks 6963 St Olavs Plass, 0130 OSLO, NO

Reg.nr: 075592 Fornyhet til: 2014.08.31
Innehaver: Anza AB, Box 133, 56423 BANKERYD, SE
Fullmektig: Oslo Patentkontor AS, Postboks 7007 Majorstua, 0306 OSLO, NO

Reg.nr: 075861 Fornyhet til: 2014.11.01
Innehaver: Telesteps AB, Box 362, 57324 TRANÅS, SE
Fullmektig: Curo AS, Industriveien 53, 7080 HEIMDAL, NO

Reg.nr: 076084 Fornyhet til: 2014.11.17
Innehaver: Dyrkorn AS, Postboks 2008 Skarbøvik, 6028 ÅLESUND, NO
Fullmektig: Onsagers AS, Postboks 6963 St Olavs Plass, 0130 OSLO, NO

Reg.nr: 078764 Fornyhet til: 2014.08.19
Innehaver: Unilever NV, Weena 455, 3013AL ROTTERDAM, NL
Fullmektig: Zacco Norway AS, Postboks 2003 Vika, 0125 OSLO, NO

Reg.nr: 078792 Fornyhet til: 2014.08.24
Innehaver: Dart Industries Inc, 14901 S Orange Blossom Trail, FL32837 ORLANDO, US
Fullmektig: Zacco Norway AS, Postboks 2003 Vika, 0125 OSLO, NO

Reg.nr: 078807 Fornyhet til: 2014.08.04
Innehaver: Rottefella AS, Industriveien 1, 3490 KLOKKARSTUA, NO
Fullmektig: Onsagers AS, Postboks 6963 St Olavs Plass, 0130 OSLO, NO

Reg.nr: 078846 Fornyhet til: 2014.08.11
Innehaver: Guerlain Societe Anonyme, 68, avenue des Champs-Élysées, 75008 PARIS, FR
Fullmektig: Oslo Patentkontor AS, Postboks 7007 Majorstua, 0306 OSLO, NO

Reg.nr: 078858 Fornyhet til: 2014.08.24
Innehaver: Dart Industries Inc, 14901 S Orange Blossom Trail, FL32837 ORLANDO, US
Fullmektig: Zacco Norway AS, Postboks 2003 Vika, 0125 OSLO, NO

Reg.nr: 078861 Fornyhet til: 2014.08.25
Innehaver: Isolaft AS, c/o Spilka Industri AS, Emblem, 6013 ÅLESUND, NO
Fullmektig: Curo AS, Industriveien 53, 7080 HEIMDAL, NO

Reg.nr: 078870 Fornyhet til: 2014.09.24
Innehaver: Sperre Mek. Verksted AS, 6057 ELLINGSØY, NO
Fullmektig: Onsagers AS, Postboks 6963 St Olavs Plass, 0130 OSLO, NO

Reg.nr: 078914 Fornyhet til: 2014.09.30
Innehaver: PI-Design AG, Postfach 463, 6234 TRIENGEN, CH
Fullmektig: Acapo AS, Postboks 1880 Nordnes, 5817 BERGEN, NO

Reg.nr: 078915 Fornyhet til: 2014.09.03
Innehaver: Elko AS, Eyvind Lyches vei 10, 1338 SANDVIKA, NO

Reg.nr: 078936 Fornyhet til: 2014.11.12
Innehaver: Sense EDM AS, Andøyfaret 7, 4623 KRISTIANSAND S, NO
Fullmektig: Protector Intellectual Property Consultants AS, Postboks 5074 Majorstua, 0301 OSLO, NO

Reg.nr: 078976 Fornyhet til: 2014.09.22
Innehaver: Henkel KGaA, Henkelstrasse 67, 40191 DÜSSELDORF, DE
Fullmektig: Zacco Norway AS, Postboks 2003 Vika, 0125 OSLO, NO

Reg.nr: 079026 Fornyhet til: 2014.08.20
Innehaver: Carl F A/S, Tempovej 31-33, 2750 BALLERUP, DK
Fullmektig: Bryn Aarflot AS, Postboks 449 Sentrum, 0104 OSLO, NO

Reg.nr: 079032 Fornyhet til: 2015.02.02
Innehaver: AB Alfort & Cronholm, Box 11043, 16111 BROMMA, SE
Fullmektig: Onsagers AS, Postboks 6963 St Olavs Plass, 0130 OSLO, NO

Reg.nr: 079087 Fornyhet til: 2014.10.21
Innehaver: Iittala Group Oyj, Hämeentie 135, 00560 HELSINGFORS, FI
Fullmektig: Oslo Patentkontor AS, Postboks 7007 Majorstua, 0306 OSLO, NO

Reg.nr: 079139 Fornyhet til: 2014.08.23
Innehaver: Johan Verde, Jonsrudveien 14, 0274 OSLO, NO
Fullmektig: Onsagers AS, Postboks 6963 St Olavs Plass, 0130 OSLO, NO