



**PATENTSTYRET**  
Styret for det industrielle rettsvern

nr 21/08 - 2008.10.06 NO

årgang 6

ISSN 1503-5808

Norsk

# design tidende

[www.patentstyret.no](http://www.patentstyret.no)

Norsk designtidende er en publikasjon som inneholder kunngjøringer innenfor designområdet

**BESØKSADRESSE**

- ▶ Københavngaten 10

**POSTADRESSE**

- ▶ Postboks 8160 Dep.  
0033 Oslo

**E-POST**

- ▶ [mail@patentstyret.no](mailto:mail@patentstyret.no)

**TELEFON**

- ▶ 22 38 73 00

**TELEFAKS**

- ▶ 22 38 73 01

**INFOSENTERETS TELEFONTID**

- ▶ kl. 09.00 - 15.00  
Telefon (+47) 22 38 73 33  
Telefaks (+47) 22 38 73 31

**Innholdsfortegnelse:**

Registrerte design .....	3
Fornyelse av registreringer .....	40

## INID-koder

I kunngjøringene er de enkelte data forsynt med koder overensstemmende med INID-kodesystemet

(INID= Internationally agreed Numbers for the Identification of Data).

- (11) Registreringsnummer
- (15) Registreringsdato
- (18) Dato som registreringen gjelder til
- (21) Søknadsnummer
- (22) Inngivelsesdato
- (30) Prioritetsopplysninger
- (43) Allment tilgjengelig dato
- (51) Klasse
- (54) Produkt
- (55) Avbildning(er)
- (72) Designer
- (73) Innehaver
- (74) Fullmektig

## Registrerte design

*I henhold til designloven § 18 første ledd i.f. kunngjøres i dag følgende registrerte design.*

Det kan fremsettes krav om at designregistreringen helt eller delvis skal oppheves, jf. designloven §§ 25 flg. og designforskriften §§ 26 flg.

Designregistreringen gjelder for den eller de periodene på fem år som søknaden er innlevert for, regnet fra søknadsdagen. Registreringen kan fornyes, jf. designloven §§ 23 og 24. Maksimal beskyttelsestid er 25 år. For reservedeler, se unntaket i designloven § 23 annet ledd.

(11)	<b>Reg.nr.:</b>	<b>081317</b>
(21)	<b>Søkn.nr.:</b>	20080155
(22)	<b>Inngitt:</b>	2008.03.10
(43)	<b>Allm. tilgj.:</b>	2008.03.10
(15)	<b>Registrert:</b>	2008.09.04
(45)	<b>Kunngjort:</b>	2008.10.06
(18)	<b>Reg. gjelder til:</b>	2013.03.10
(55)	<b>Avbildning(er):</b>	



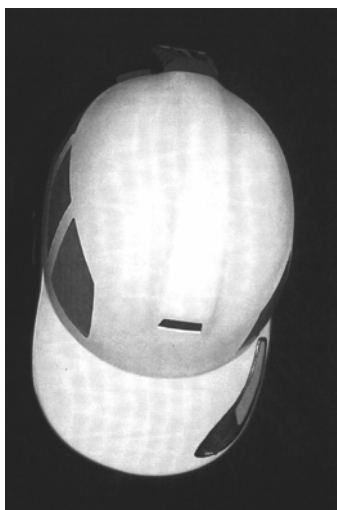
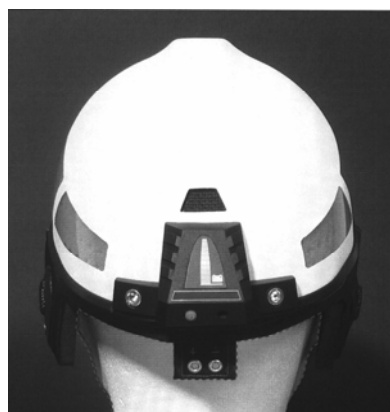

Detaljutsnitt

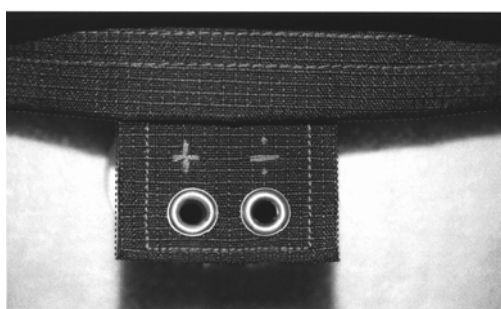

Detaljutsnitt



Detaljutsnitt

- (54) **Produkt:** Vernehjelm med hørselvern  
(51) **Klasse:** 02-03  
(73) **Innehaver:** Tore Christian Storholmen, Kristiansfelt gate 2, 7013 TRONDHEIM, NO  
(72) **Designer:** Tore Christian Bjørsvik Storholmen, Kristiansfelt gate 2, 7013 TRONDHEIM, NO
-

(11) **Reg.nr.:** 081318  
(21) **Søkn.nr.:** 20080274  
(22) **Inngitt:** 2008.05.14  
(43) **Allm. tilgj.:** 2008.09.05  
(15) **Registrert:** 2008.09.05  
(45) **Kunngjort:** 2008.10.06  
(18) **Reg. gjelder til:** 2013.05.14  
(55) **Avbildning(er):**

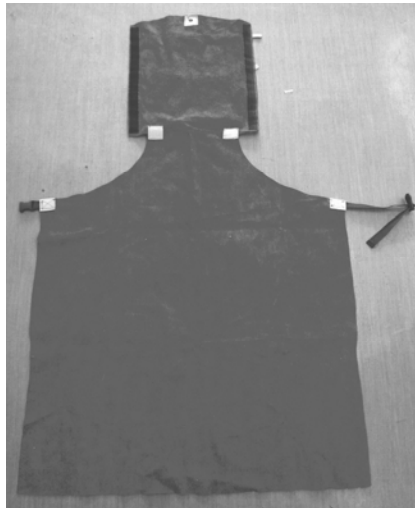

(54) **Produkt:** Sveiseforkle  
(51) **Klasse:** 02-02  
(73) **Innehaver:** Trond Olav Testad, Haugdom, 4440 TONSTAD, NO  
(72) **Designer:** Trond Olav Testad, Haugdom, 4440 TONSTAD, NO

---

(11) **Reg.nr.:** 081319  
(21) **Søkn.nr.:** 20080272  
(22) **Inngitt:** 2008.05.14  
(43) **Allm. tilgj.:** 2008.09.08  
(15) **Registrert:** 2008.09.08  
(45) **Kunngjort:** 2008.10.06  
(18) **Reg. gjelder til:** 2013.05.14  
(55) **Avbildning(er):**

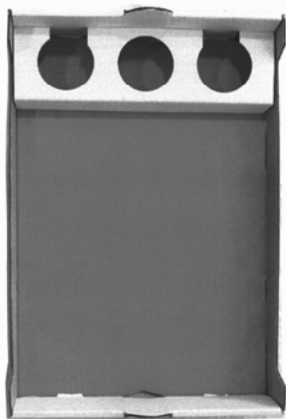
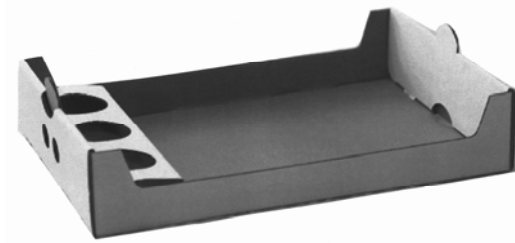
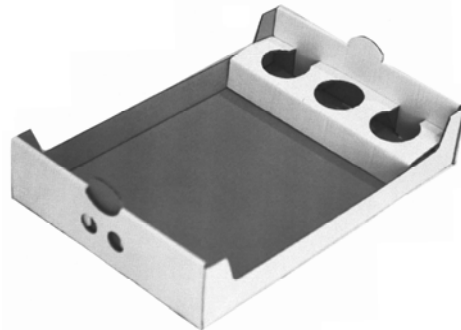

(74) **Fullmektig:** Norsk Patentbyrå AS, Gjerdrums Vei 12, 0484 OSLO, NO  
(54) **Produkt:** Eske for servering av mat og drikke  
(51) **Klasse:** 09-03  
(73) **Innehaver:** Brunstad Conference Center AS, Brunstad Stevnested, 3159 MELSOMVIK, NO  
(72) **Designer:** Brunstad Conference Center AS, Brunstad Stevnested, 3159 MELSOMVIK, NO

(11) **Reg.nr.:** 081320  
(21) **Søkn.nr.:** 20080254  
(22) **Inngitt:** 2008.04.28  
(43) **Allm. tilgj.:** 2008.09.01  
(15) **Registrert:** 2008.09.08  
(45) **Kunngjort:** 2008.10.06  
(18) **Reg. gjelder til:** 2013.04.28  
(55) **Avbildning(er):**

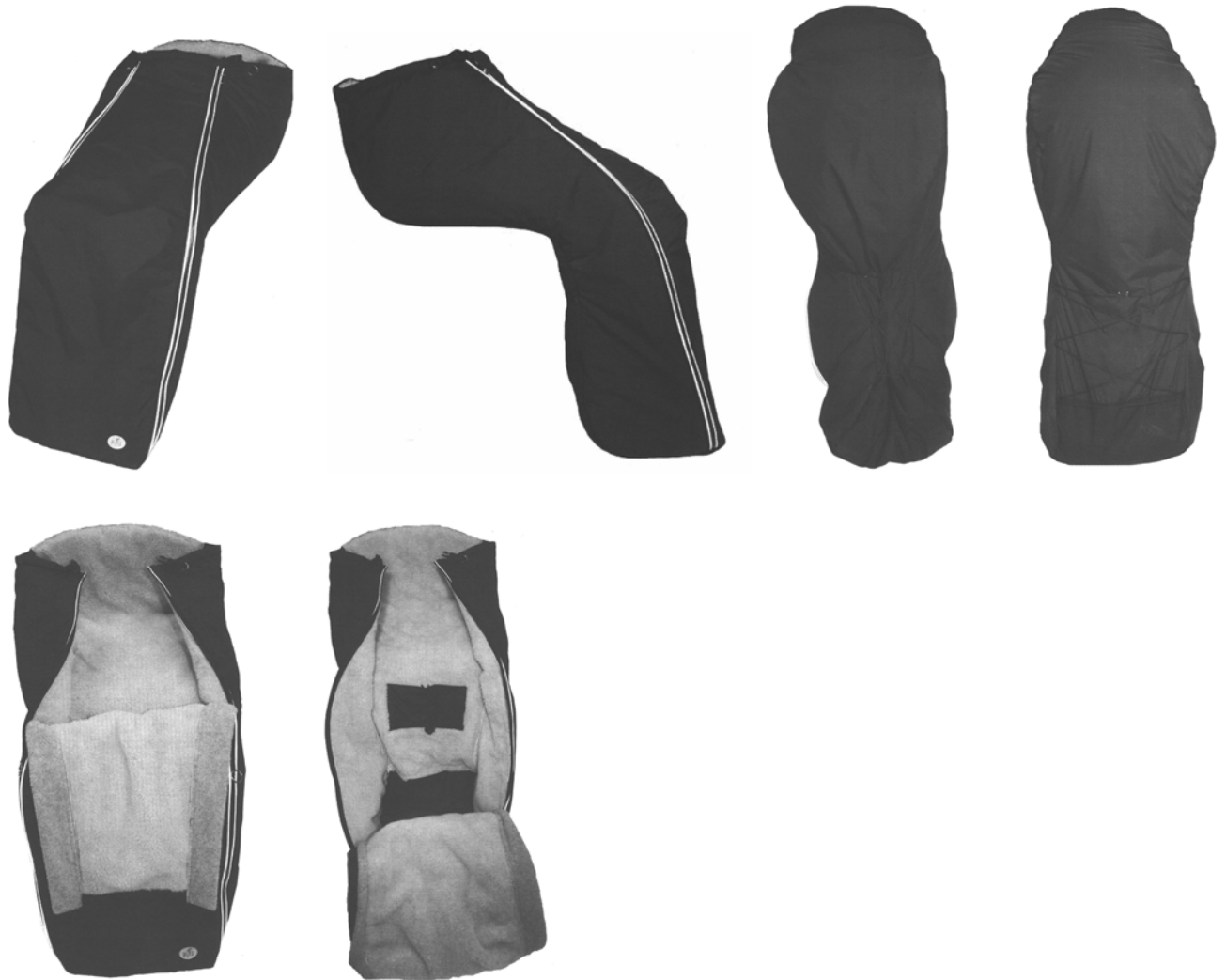

(54) **Produkt:** Kjørepose  
(51) **Klasse:** 06-13  
(73) **Innehaver:** Øytex AS, Fanøy, 6917 BATALDEN, NO  
(72) **Designer:** Øytex AS, Fanøy, 6917 BATALDEN, NO

- (11) **Reg.nr.:** 081321
- (21) **Søkn.nr.:** 20080097
- (22) **Inngitt:** 2008.02.12
- (43) **Allm. tilgj.:** 2008.08.12
- (15) **Registrert:** 2008.09.09
- (45) **Kunngjort:** 2008.10.06
- (18) **Reg. gjelder til:** 2013.02.12
- (55) **Avbildning(er):**

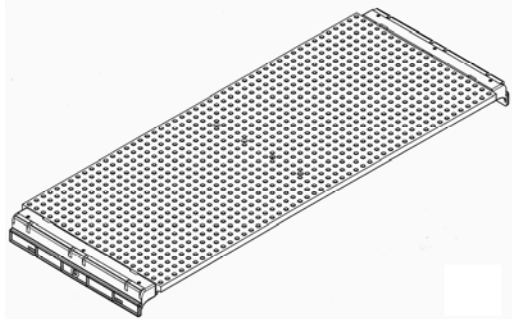

1.1

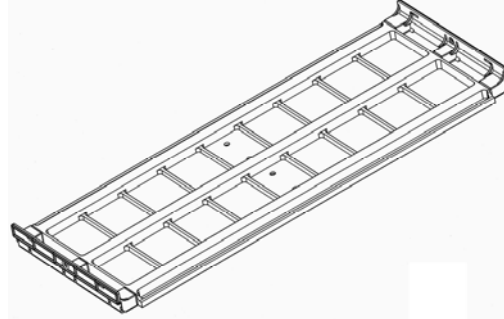

1.2

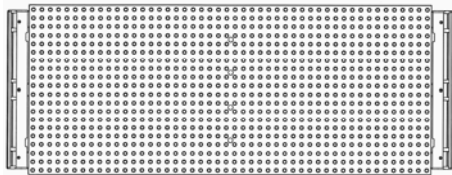

1.3

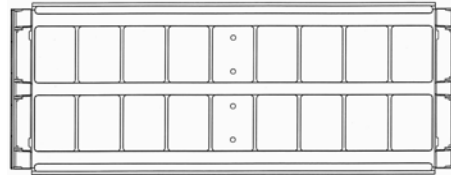

1.4

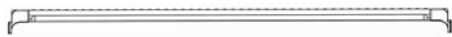

1.5

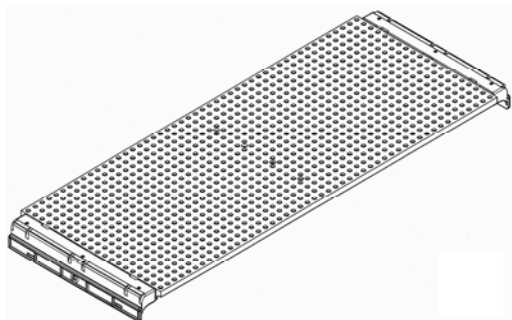

2.1

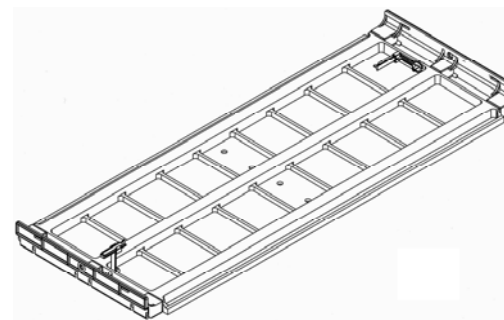

2.2

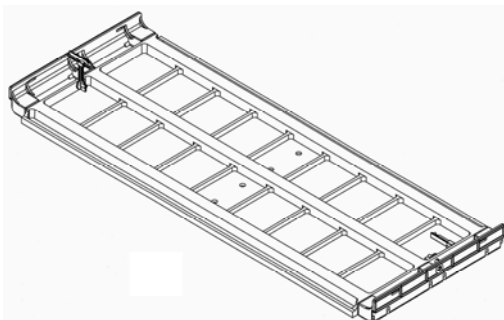

2.3

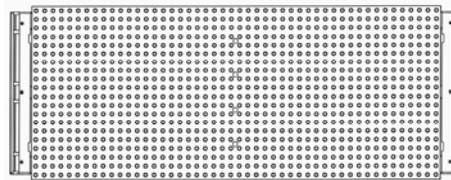

2.4



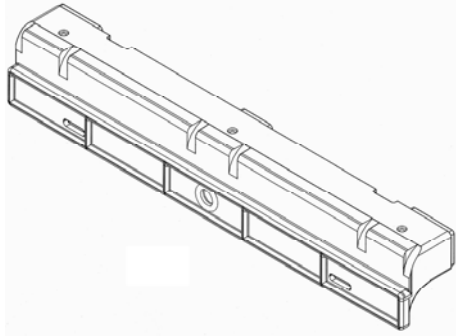

3.1

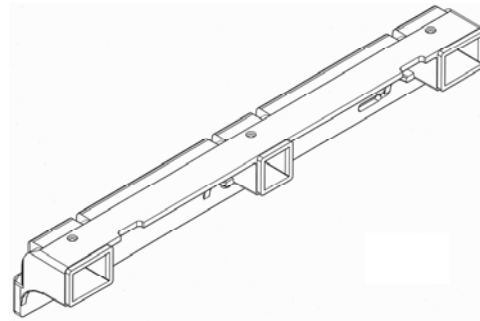

3.2

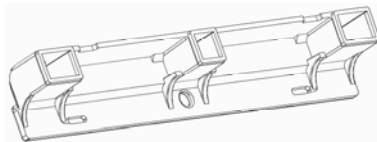

3.3

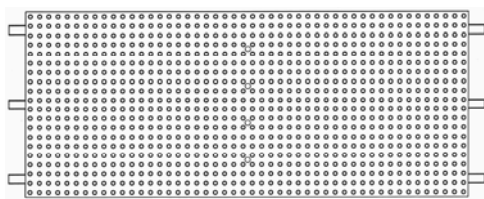

4.1

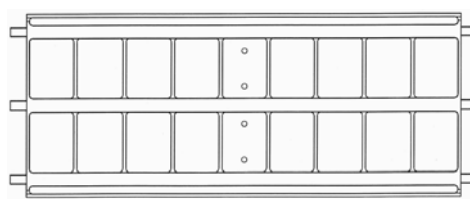

4.2



4.3



4.4

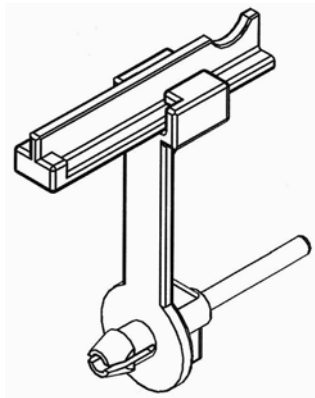

5.1

- (74) **Fullmektig:** Zacco Norway AS, Postboks 2003 Vika, 0125 OSLO, NO  
 (54) **Produkt:** 1. Stillaslabank  
 2. Stillaslabank  
 3. Endestykke til stillaslabank  
 4. Midtdel av stillaslabank  
 5. Sikringsbeslag for stillaslabank  
 (51) **Klasse:** 1-5. 25-04  
 (73) **Innehaver:** RH Products International AS, Njords vei 2F, 4631 KRISTIANSAND S, NO  
 (72) **Designer:** Rolf Heggland, Njords v 2F, 4631 KRISTIANSAND S, NO

(11) Reg.nr.: 081322  
(21) Søkn.nr.: 20080222  
(22) Inngitt: 2008.04.10  
(43) Allm. tilgj.: 2008.04.10  
(15) Registrert: 2008.09.09  
(45) Kunngjort: 2008.10.06  
(18) Reg. gjelder til: 2013.04.10  
(55) Avbildning(er):



1.1



1.2



1.3

Detaljutsnitt

Detaljutsnitt



2.1



2.2



2.3

Detaljutsnitt

Detaljutsnitt



3.1



3.2



3.3

Detaljutsnitt

Detaljutsnitt

- (54) **Produkt:** 1-3. Festdrakt  
(51) **Klasse:** 1-3. 02-02  
(73) **Innehaver:** Lise's Systue, v/ A.L. Hermansen, Osloveien 290, 1440 DRØBAK, NO  
(72) **Designer:** Lise's Systue, v/ A.L. Hermansen, Osloveien 290, 1440 DRØBAK, NO  
(60) **Anmerkning:** Designene er i farger.  
Registreringen gjelder samregistrering.

- (11) **Reg.nr.:** 081323  
(21) **Søkn.nr.:** 20080152  
(22) **Inngitt:** 2008.03.04  
(43) **Allm. tilgj.:** 2008.09.04  
(15) **Registrert:** 2008.09.09  
(45) **Kunngjort:** 2008.10.06  
(18) **Reg. gjelder til:** 2013.03.04  
(55) **Avbildning(er):**

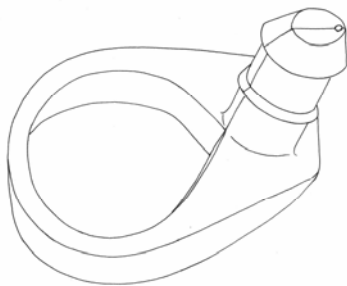

1.1

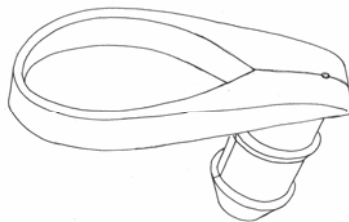

1.2

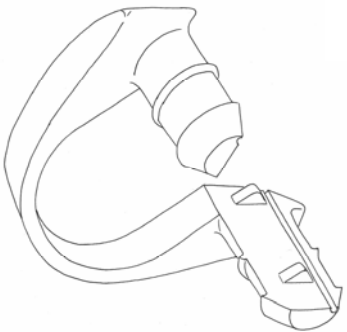

1.3

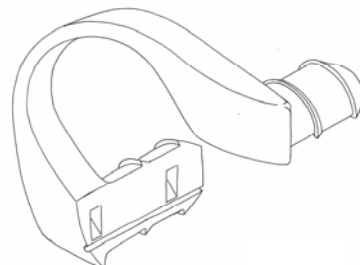

1.4

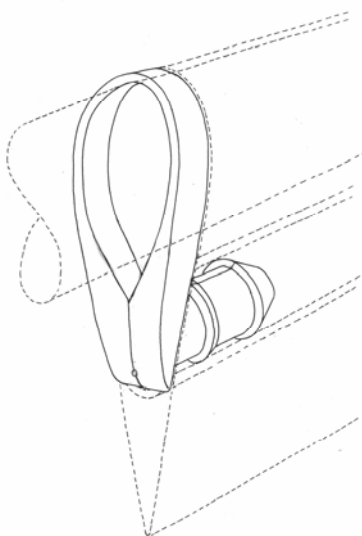

1.5

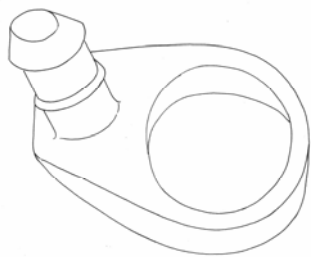

2.1

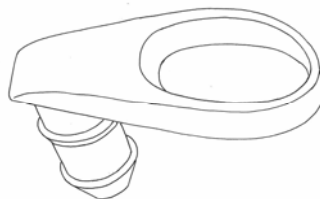

2.2

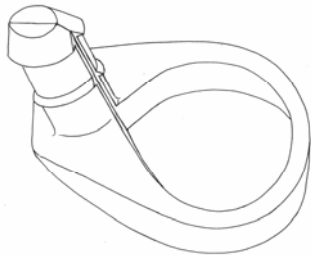

3.1

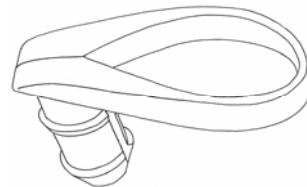

3.2

- (54) **Produkt:** 1-3. Trust-gliidelager for fairing
- (51) **Klasse:** 1-3. 08-08
- (73) **Innehaver:** Gunnar Parmann, c/o Parma Plast AS, Straume Næringspark, Smålonane, 5353 STRAUME, NO  
Georg Parmann, c/o Parma Plast AS, Straume Næringspark, Smålonane, 5353 STRAUME, NO  
Christian Parmann, c/o Parma Plast AS, Straume Næringspark, Smålonane, 5353 STRAUME, NO
- (72) **Designer:** Gunnar Parmann, c/o Parma Plast AS, Straume Næringspark, Smålonane, 5353 STRAUME, NO  
Georg Parmann, c/o Parma Plast AS, Straume Næringspark, Smålonane, 5353 STRAUME, NO  
Christian Parmann, c/o Parma Plast AS, Straume Næringspark, Smålonane, 5353 STRAUME, NO
- (60) **Anmerkning:** Registreringen gjelder samregistrering.

(11)	<b>Reg.nr.:</b>	<b>081324</b>
(21)	<b>Søkn.nr.:</b>	20070674
(22)	<b>Inngitt:</b>	2007.10.30
(43)	<b>Allm. tilgj.:</b>	2007.10.30
(15)	<b>Registrert:</b>	2008.09.09
(45)	<b>Kunngjort:</b>	2008.10.06
(18)	<b>Reg. gjelder til:</b>	2012.10.30
(55)	<b>Avbildning(er):</b>	

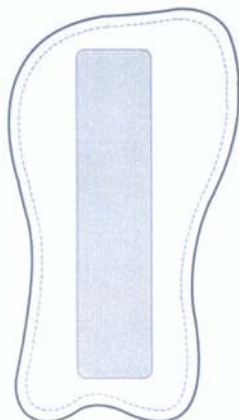

1.1



2.1



2.2

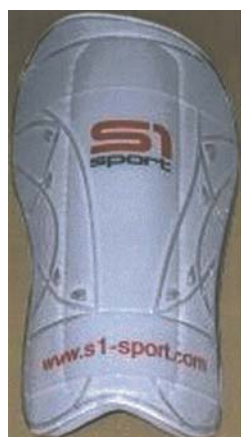

3.1

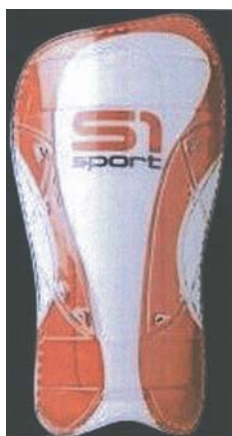

4.1

(74)	<b>Fullmektig:</b>	Acapo AS, Postboks 1880 Nordnes, 5817 BERGEN, NO
(54)	<b>Produkt:</b>	1-4. Skinnebensbeskytter
(51)	<b>Klasse:</b>	1-4. 02-99
(73)	<b>Innehaver:</b>	Task Force Properties & Investments Ltd, Millenium House, Moss Road, CM83UQ WITHAM, ESSEX, GB
(72)	<b>Designer:</b>	Harald Scheffer, St. Georgstrasse 60a, 66663 MERZIG, DE Robert Steed, The White House, Maypole Road, CM83LX WICKHAM BISHOPS, GB
(30)	<b>Prioritet:</b>	2007.04.30 EM 000715297
(60)	<b>Anmerkning:</b>	Design nr. 2, 3 og 4 er i farger. Registreringen gjelder samregistrering.

(11)	<b>Reg.nr.:</b>	<b>081325</b>
(21)	<b>Søkn.nr.:</b>	20080148
(22)	<b>Inngitt:</b>	2008.03.03
(43)	<b>Allm. tilgj.:</b>	2008.09.03
(15)	<b>Registrert:</b>	2008.09.09
(45)	<b>Kunngjort:</b>	2008.10.06
(18)	<b>Reg. gjelder til:</b>	2013.03.03
(55)	<b>Avbildning(er):</b>	

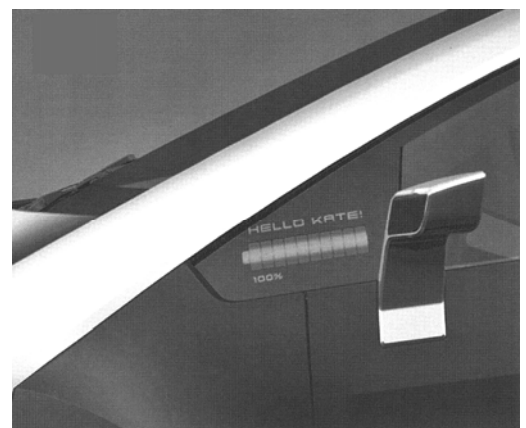
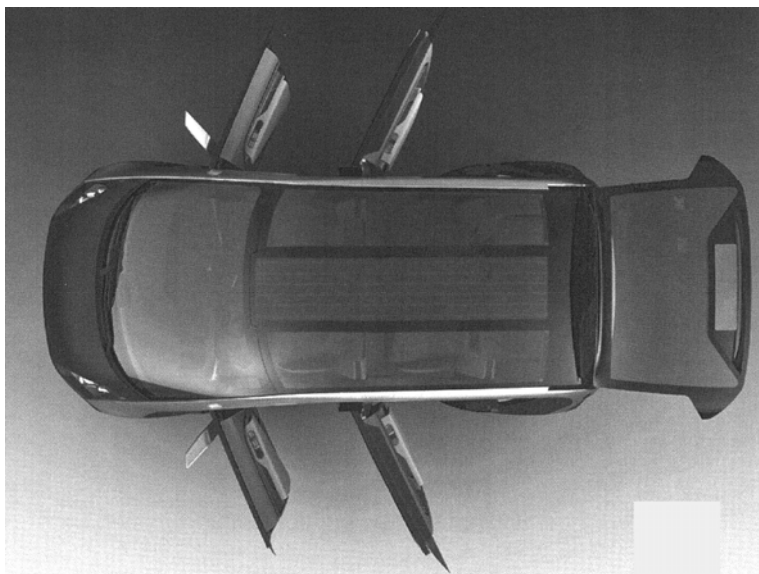
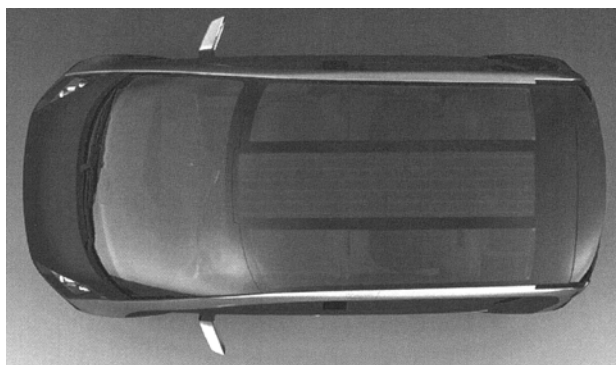
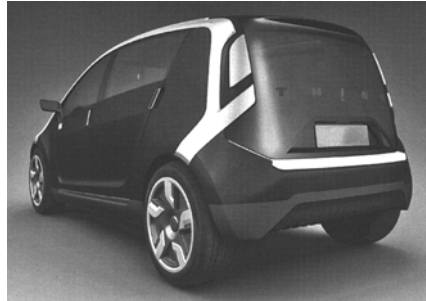
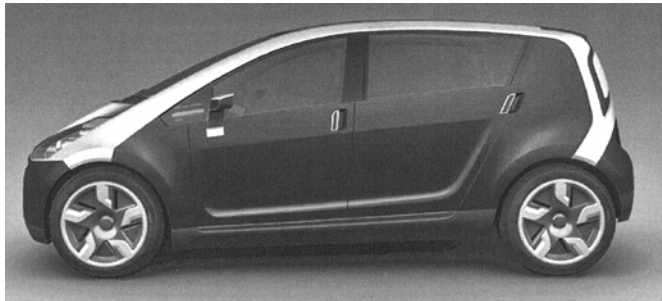

Detaljutsnitt

(74)	<b>Fullmektig:</b>	Zacco Norway AS, Postboks 2003 Vika, 0125 OSLO, NO
(54)	<b>Produkt:</b>	Bil
(51)	<b>Klasse:</b>	12-08
(73)	<b>Innehaver:</b>	Think Global AS, Sandakerveien 24 C bygg A, Myrens Verksted, 0473 OSLO, NO
(72)	<b>Designer:</b>	Think Global AS, Sandakerveien 24 C bygg A, Myrens Verksted, 0473 OSLO, NO

(11) **Reg.nr.:** 081326  
(21) **Søkn.nr.:** 20080280  
(22) **Inngitt:** 2008.05.15  
(43) **Allm. tilgj.:** 2008.09.10  
(15) **Registrert:** 2008.09.10  
(45) **Kunngjort:** 2008.10.06  
(18) **Reg. gjelder til:** 2013.05.15  
(55) **Avbildning(er):**



1.1



1.2



1.3



1.4



1.5



1.6



2.1



2.2



2.3



2.4



2.5



2.6

(74) **Fullmektig:** Onsagers AS, Postboks 6963 St Olavs Plass, 0130 OSLO, NO  
(54) **Produkt:** 1-2. Spiselig tyggeprodukt for hunder  
(51) **Klasse:** 1-2. 01-06  
(73) **Innehaver:** Mars Inc, 6885 Elm Street, VA22101-3883 MCLEAN, US  
(72) **Designer:** David Wylie, 15 Edward Street, HX78DF HEBDEN BRIDGE, WEST YORKSHIRE, GB  
(60) **Anmerkning:** Designene er i farger.  
Registreringen gjelder samregistrering.

- (11) **Reg.nr.:** 081327
- (21) **Søkn.nr.:** 20080046
- (22) **Inngitt:** 2008.01.24
- (43) **Allm. tilgj.:** 2008.01.27
- (15) **Registrert:** 2008.09.10
- (45) **Kunngjort:** 2008.10.06
- (18) **Reg. gjelder til:** 2013.01.24
- (55) **Avbildning(er):**

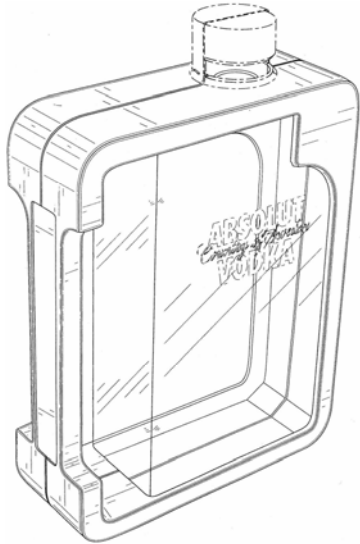

1.1



1.2

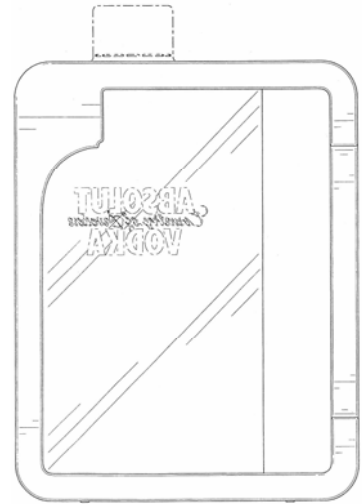

1.3



1.4



1.5



1.6

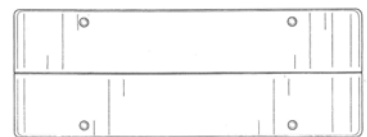

1.7

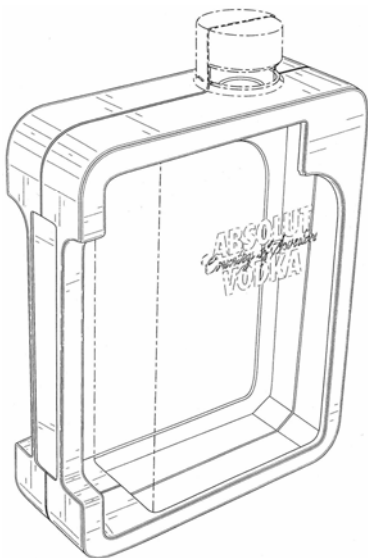

2.1



2.2

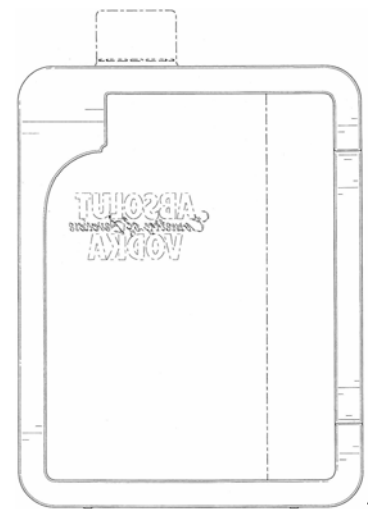

2.3



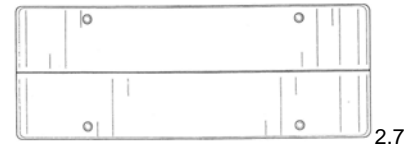
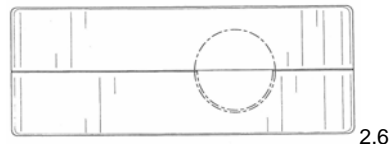
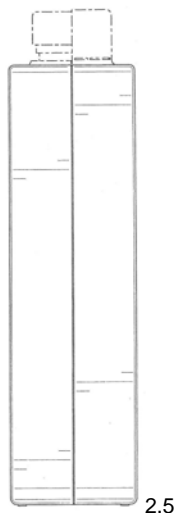
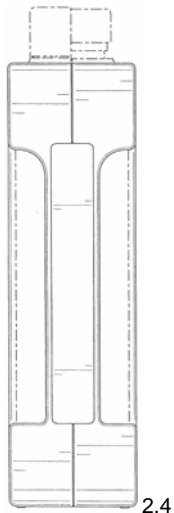

- (74) **Fullmektig:** Zacco Norway AS, Postboks 2003 Vika, 0125 OSLO, NO  
(54) **Produkt:** 1-2. Flaske  
(51) **Klasse:** 1-2. 09-01  
(73) **Innehaver:** V & S Vin & Sprit AB (publ), 11797 STOCKHOLM, SE  
(72) **Designer:** Marcus Gabrielsson, Atlasmuren 4, 11321 STOCKHOLM, SE  
Jacob Boije, Jägmästargatan 12, 11542 STOCKHOLM, SE  
Ulrika Ewerman, Götgatan 122, 11862 STOCKHOLM, SE  
John Grieves, Frejgatan 32, 11326 STOCKHOLM, SE  
August Michael, Utansjövägen 14, 12247 ENSKEDE, SE
- (30) **Prioritet:** 2007.07.27 US 29/287,358  
(60) **Anmerkning:** Registreringen gjelder samregistrering.

(11)	<b>Reg.nr.:</b>	<b>081328</b>
(21)	<b>Søkn.nr.:</b>	20080225
(22)	<b>Inngitt:</b>	2008.04.15
(43)	<b>Allm. tilgj.:</b>	2008.04.15
(15)	<b>Registrert:</b>	2008.09.10
(45)	<b>Kunngjort:</b>	2008.10.06
(18)	<b>Reg. gjelder til:</b>	2013.04.15
(55)	<b>Avbildning(er):</b>	



1.1



2.1



3.1



4.1

(74)	<b>Fullmektig:</b>	Zacco Norway AS, Postboks 2003 Vika, 0125 OSLO, NO
(54)	<b>Produkt:</b>	1-4. Piktogram for tetningselement til bruk på vinduer og dører (ornament)
(51)	<b>Klasse:</b>	1-4. 99-00
(73)	<b>Innehaver:</b>	tesa AG, Quickbornstrasse 24, 20253 HAMBURG, DE
(72)	<b>Designer:</b>	Daniel Graf, Heinrich-Lohse Strasse 66, 25451 QUICKBORN, DE
(30)	<b>Prioritet:</b>	2007.12.14 EM 000843354
(60)	<b>Anmerkning:</b>	Design nr. 2 og 4 er i farger. Registreringen gjelder samregistrering.

(11) **Reg.nr.:** 081329  
(21) **Søkn.nr.:** 20080257  
(22) **Inngitt:** 2008.05.05  
(43) **Allm. tilgj.:** 2008.05.06  
(15) **Registrert:** 2008.09.10  
(45) **Kunngjort:** 2008.10.06  
(18) **Reg. gjelder til:** 2013.05.05  
(55) **Avbildning(er):**

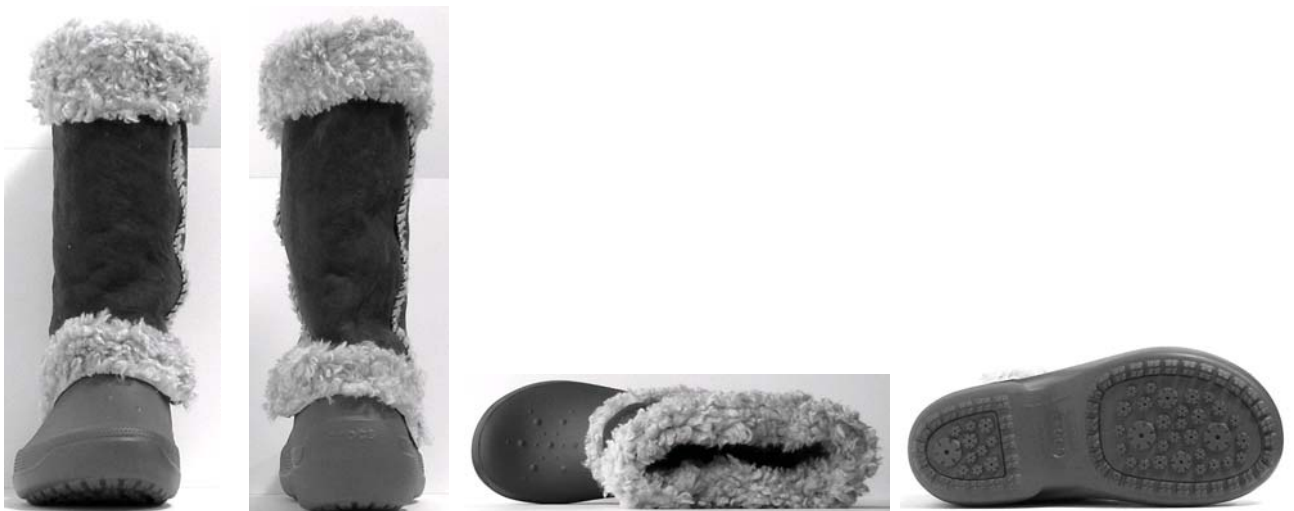

(74) **Fullmektig:** Bryn Aarflot AS, Postboks 449 Sentrum, 0104 OSLO, NO  
(54) **Produkt:** Fottøy  
(51) **Klasse:** 02-04  
(73) **Innehaver:** Crocs Inc, 6328 Monarch Park Place, CO80503 NIWOT, US  
(72) **Designer:** Stefano del Biondi, via Salata 25 NOVENTA PADOVANA PD, IT  
Marianna Zuin, 3 Novembre 29, 35020 VILLATORA DI SAONARA, IT  
(30) **Prioritet:** 2008.01.18 US 29/302,592

(11) **Reg.nr.:** 081330  
(21) **Søkn.nr.:** 20080283  
(22) **Inngitt:** 2008.05.16  
(43) **Allm. tilgj.:** 2008.05.22  
(15) **Registrert:** 2008.09.10  
(45) **Kunngjort:** 2008.10.06  
(18) **Reg. gjelder til:** 2013.05.16  
(55) **Avbildning(er):**



(74) **Fullmektig:** Onsagers AS, Postboks 6963 St Olavs Plass, 0130 OSLO, NO  
(54) **Produkt:** Spiselig tyggeprodukt for hunder  
(51) **Klasse:** 01-06  
(73) **Innehaver:** Mars Inc, 6885 Elm Street, VA22101-3883 MCLEAN, US  
(72) **Designer:** David Wylie, 15 Edward Street, HX78DF HEBDEN BRIDGE, WEST YORKSHIRE, GB  
(30) **Prioritet:** 2007.11.22 EM 000830583  
(60) **Anmerkning:** Designen er i farger.

---

(11) **Reg.nr.:** 081331  
(21) **Søkn.nr.:** 20080135  
(22) **Inngitt:** 2008.02.28  
(43) **Allm. tilgj.:** 2008.02.29  
(15) **Registrert:** 2008.09.10  
(45) **Kunngjort:** 2008.10.06  
(18) **Reg. gjelder til:** 2013.02.28  
(55) **Avbildning(er):**



(74) **Fullmektig:** Bryn Aarflot AS, Postboks 449 Sentrum, 0104 OSLO, NO  
(54) **Produkt:** Armbånd  
(51) **Klasse:** 11-01  
(73) **Innehaver:** Martina of Sweden ApS, Hambros Alle 3, 2900 HELLERUP, DK  
(72) **Designer:** Martina of Sweden ApS, Hambros Alle 3, 2900 HELLERUP, DK  
(30) **Prioritet:** 2007.08.30 EM 000786116  
(60) **Anmerkning:** Designen er i farger.

(11)	<b>Reg.nr.:</b>	<b>081332</b>
(21)	<b>Søkn.nr.:</b>	20080195
(22)	<b>Inngitt:</b>	2008.03.29
(43)	<b>Allm. tilgj.:</b>	2008.03.29
(15)	<b>Registrert:</b>	2008.09.10
(45)	<b>Kunngjort:</b>	2008.10.06
(18)	<b>Reg. gjelder til:</b>	2013.03.29
(55)	<b>Avbildning(er):</b>	

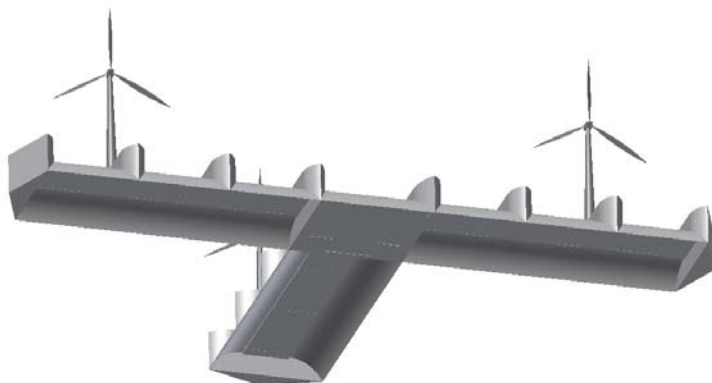
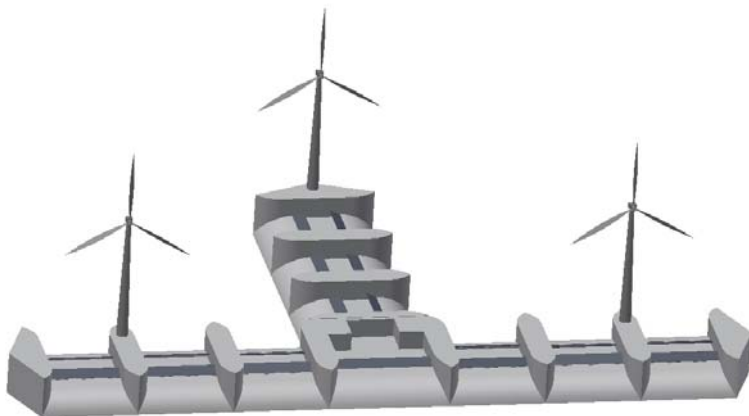
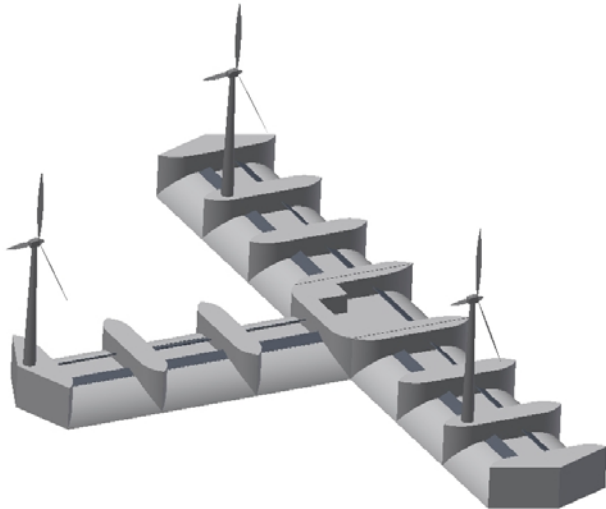

(54)	<b>Produkt:</b>	Bølge- og vindkraftverk (hybrid)
(51)	<b>Klasse:</b>	25-03
(73)	<b>Innehaver:</b>	Ånund Ottesen, Sundgot, 6065 ULSTEINVIK, NO
(72)	<b>Designer:</b>	Ånund Ottesen, Sundgot, 6065 ULSTEINVIK, NO

- (11) **Reg.nr.:** 081333
- (21) **Søkn.nr.:** 20080277
- (22) **Inngitt:** 2008.05.14
- (43) **Allm. tilgj.:** 2008.05.15
- (15) **Registrert:** 2008.09.10
- (45) **Kunngjort:** 2008.10.06
- (18) **Reg. gjelder til:** 2013.05.14
- (55) **Avbildning(er):**



1.1

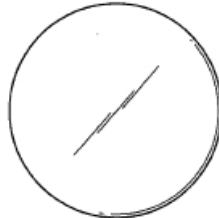

1.2

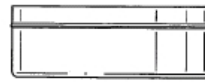

1.3

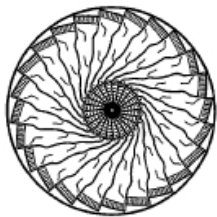

2.1

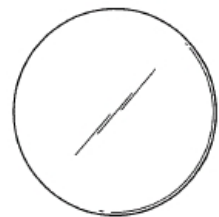

2.2

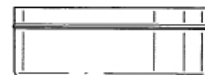

2.3



3.1

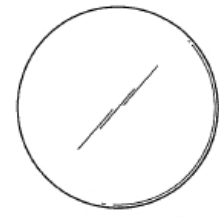

3.2



3.3

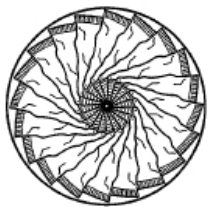

4.1

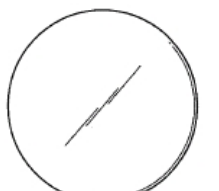

4.2



4.3



5.1

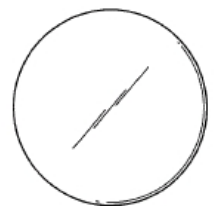

5.2

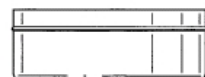

5.3



6.1

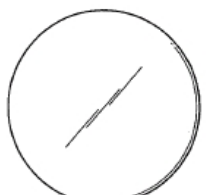

6.2



6.3



7.1

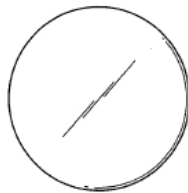

7.2



7.3



8.1

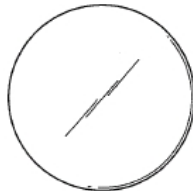

8.2



8.3

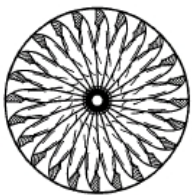

9.1

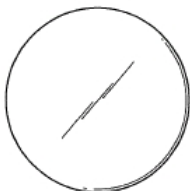

9.2



9.3

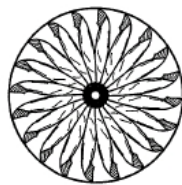

10.1

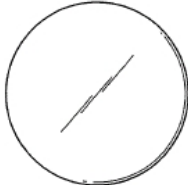

10.2



10.3

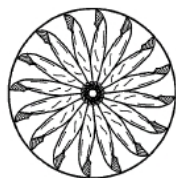

11.1

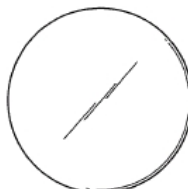

11.2



11.3

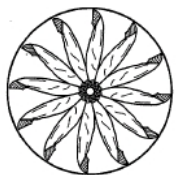

12.1

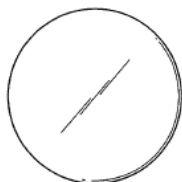

12.2



12.3

- (74) **Fullmektig:** Protector Intellectual Property Consultants AS, Postboks 5074 Majorstua, 0301 OSLO, NO  
 (54) **Produkt:** 1-12. Snusdåse med porsjonssnus  
 (51) **Klasse:** 1-12. 27-01, 27-06  
 (73) **Innehaver:** Swedish Match North Europe AB, 11885 STOCKHOLM, SE  
 (72) **Designer:** Anna Neiås, c/o Swedish Match North Europe AB, 11885 STOCKHOLM, SE  
 (30) **Prioritet:** 2007.11.15 SE 070570  
 (60) **Anmerkning:** Registreringen gjelder samregistrering.



(11) **Reg.nr.:** 081334  
(21) **Søkn.nr.:** 20080219  
(22) **Inngitt:** 2008.04.11  
(43) **Allm. tilgj.:** 2008.04.12  
(15) **Registrert:** 2008.09.10  
(45) **Kunngjort:** 2008.10.06  
(18) **Reg. gjelder til:** 2013.04.11  
(55) **Avbildning(er):**

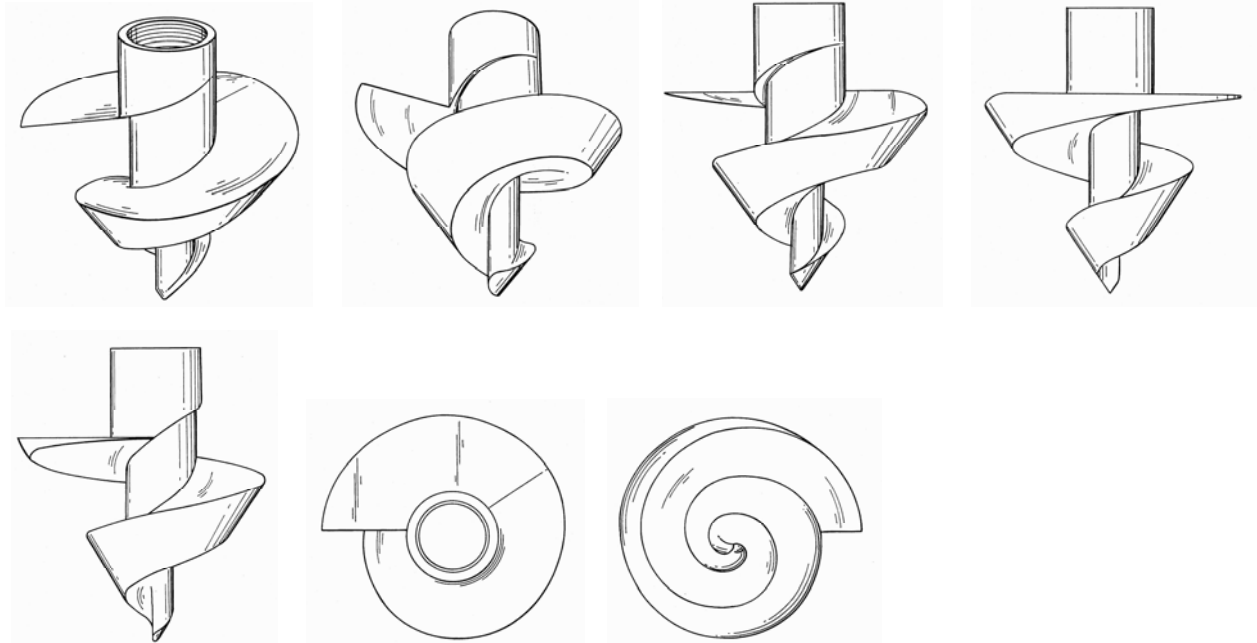

(74) **Fullmektig:** Zacco Norway AS, Postboks 2003 Vika, 0125 OSLO, NO  
(54) **Produkt:** Del av uttrekksverktøy  
(51) **Klasse:** 08-05  
(73) **Innehaver:** Pyrotek Engineering Materials Ltd, Garamonde Drive, MK88LN WYMBUSH, MILTON KEYNES, GB  
(72) **Designer:** Mark Vincent, 19 Hydrus Drive, LU78UL LEIGHTON BUZZARD, BEDFORDSHIRE, GB  
(30) **Prioritet:** 2007.10.12 EM 000807608

(11) **Reg.nr.:** 081335  
(21) **Søkn.nr.:** 20080065  
(22) **Inngitt:** 2008.01.31  
(43) **Allm. tilgj.:** 2008.07.31  
(15) **Registrert:** 2008.09.12  
(45) **Kunngjort:** 2008.10.06  
(18) **Reg. gjelder til:** 2013.01.31  
(55) **Avbildning(er):**

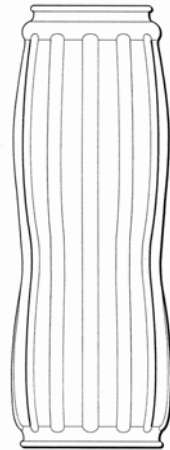
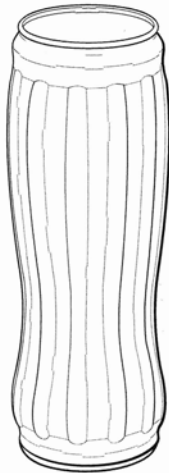
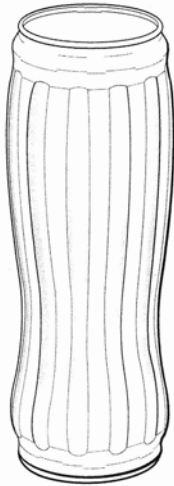

(74) **Fullmektig:** Zacco Norway AS, Postboks 2003 Vika, 0125 OSLO, NO  
(54) **Produkt:** Beholder  
(51) **Klasse:** 09-02, 09-03  
(73) **Innehaver:** Slaur Chauvet, 192 rue de la Vallée, 76600 LE HAVRE, FR  
(72) **Designer:** M Jean-Marc Albert, Domaine de Fleurenne, 33290 BLANQUEFORT, FR

(11) **Reg.nr.:** 081336  
(21) **Søkn.nr.:** 20080295  
(22) **Inngitt:** 2008.05.23  
(43) **Allm. tilgj.:** 2008.05.23  
(15) **Registrert:** 2008.09.12  
(45) **Kunngjort:** 2008.10.06  
(18) **Reg. gjelder til:** 2013.05.23  
(55) **Avbildning(er):**

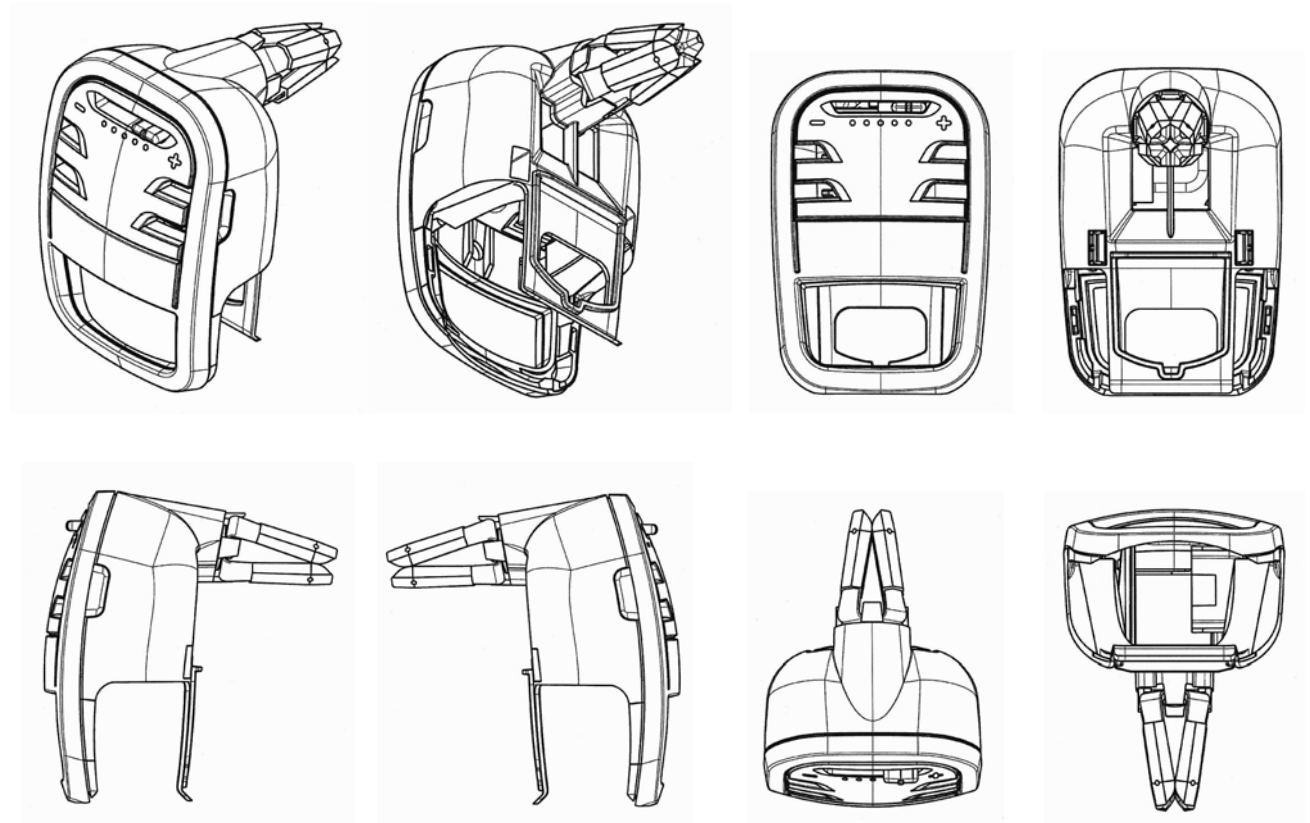

(74) **Fullmektig:** Zacco Norway AS, Postboks 2003 Vika, 0125 OSLO, NO  
(54) **Produkt:** Luftrensener/luftfjerner/luftdispenser  
(51) **Klasse:** 23-04  
(73) **Innehaver:** Sara Lee Household and Body Care Nederland BV, Vleutensevaart 35, 3532AD UTRECHT, NL  
(72) **Designer:** Bjorn Weggelaar, Gaelstraat 7, 2013CE HAARLEM, NL  
(30) **Prioritet:** 2008.03.12 EM 000896768

- (11) **Reg.nr.:** 081337  
 (21) **Søkn.nr.:** 20080251  
 (22) **Inngitt:** 2008.04.28  
 (43) **Allm. tilgj.:** 2008.09.05  
 (15) **Registrert:** 2008.09.15  
 (45) **Kunngjort:** 2008.10.06  
 (18) **Reg. gjelder til:** 2013.04.28  
 (55) **Avbildning(er):**

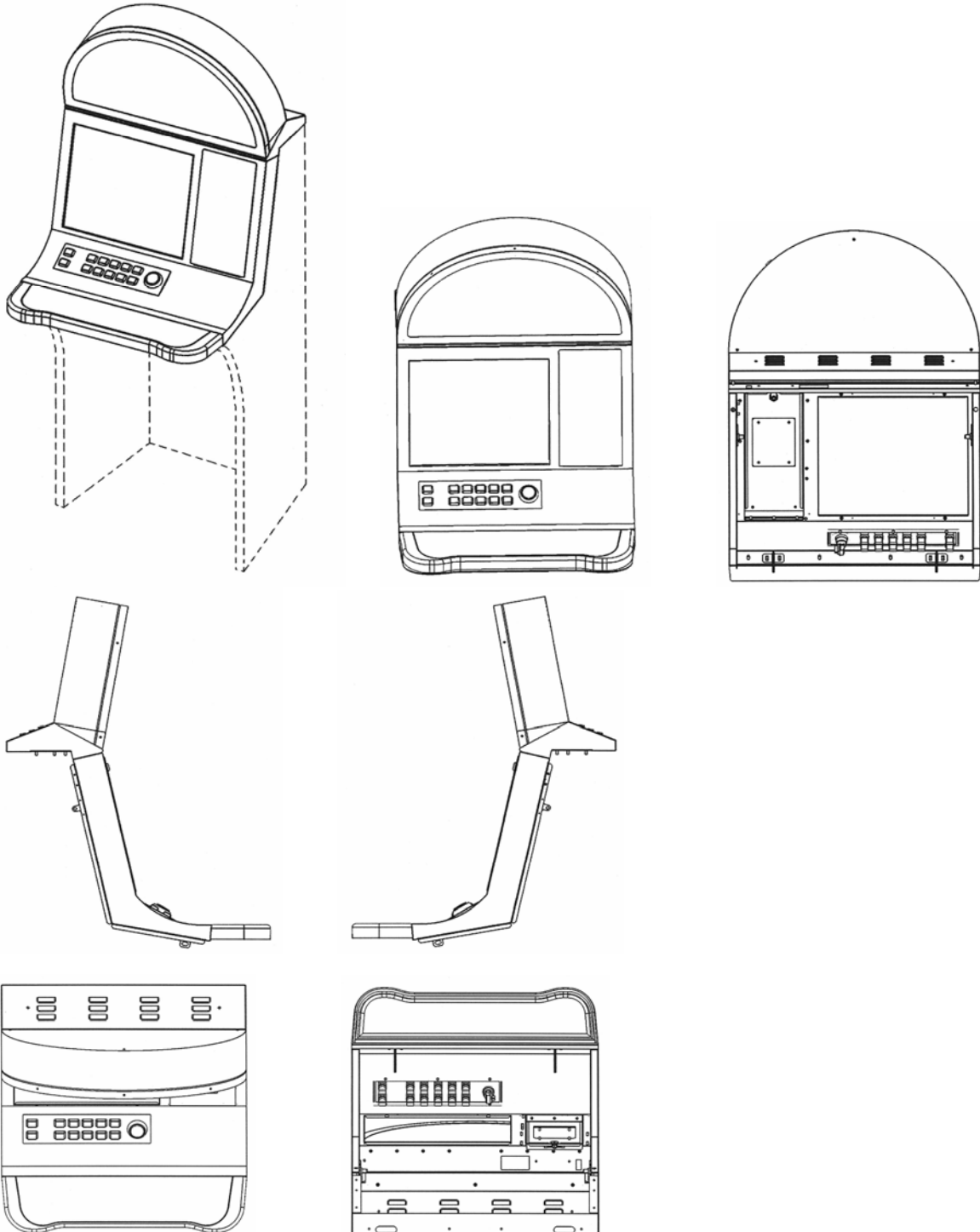

- (74) **Fullmektig:** Zacco Norway AS, Postboks 2003 Vika, 0125 OSLO, NO  
 (54) **Produkt:** Spilleautomat  
 (51) **Klasse:** 21-03  
 (73) **Innehaver:** Proindumar S L, Plaza de Cronos 4, 28037 MADRID, ES  
 (72) **Designer:** Jesús Franco Muños, Plaza de Cronos 4, 28037 MADRID, ES  
 (30) **Prioritet:** 2008.03.05 EM 000891619

(11)	<b>Reg.nr.:</b>	<b>081338</b>
(21)	<b>Søkn.nr.:</b>	20080304
(22)	<b>Inngitt:</b>	2008.05.30
(43)	<b>Allm. tilgj.:</b>	2008.09.16
(15)	<b>Registrert:</b>	2008.09.16
(45)	<b>Kunngjort:</b>	2008.10.06
(18)	<b>Reg. gjelder til:</b>	2013.05.30
(55)	<b>Avbildning(er):</b>	



(74)	<b>Fullmektig:</b>	Leogriff AS, Postboks 79 Tåsen, 0801 OSLO, NO
(54)	<b>Produkt:</b>	Kommunikasjonsenhet
(51)	<b>Klasse:</b>	14-03
(73)	<b>Innehaver:</b>	Forsvarets Forskningsinstitutt, Postboks 25, 2027 KJELLER, NO
(72)	<b>Designer:</b>	Espen Bergsted Hoff, Daleneveien 978, 3158 ANDEBU, NO

(11)	<b>Reg.nr.:</b>	<b>081339</b>
(21)	<b>Søkn.nr.:</b>	20080285
(22)	<b>Inngitt:</b>	2008.05.21
(43)	<b>Allm. tilgj.:</b>	2008.06.11
(15)	<b>Registrert:</b>	2008.09.17
(45)	<b>Kunngjort:</b>	2008.10.06
(18)	<b>Reg. gjelder til:</b>	2013.05.21
(55)	<b>Avbildning(er):</b>	

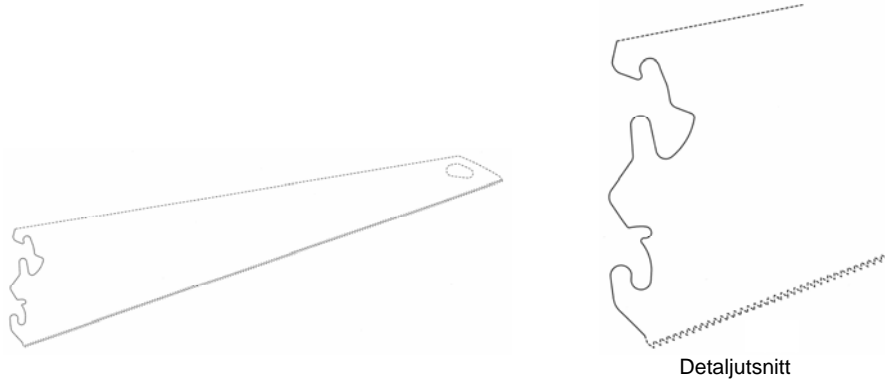

(74)	<b>Fullmektig:</b>	Onsagers AS, Postboks 6963 St Olavs Plass, 0130 OSLO, NO
(54)	<b>Produkt:</b>	Del av sagblad
(51)	<b>Klasse:</b>	08-03
(73)	<b>Innehaver:</b>	Kapman AB, c/o SNA Europe (Industries) AB, 81181 SANDVIKEN, SE
(72)	<b>Designer:</b>	Conny Jansson, Fågelviksvägen 24, 72348 VÄSTERÅS, SE Hans Himbert, Olof Dahlins Väg 18, 11252 STOCKHOLM, SE Mårten Andrén, Flystaslingan 8, 16346 SPÅNGA, SE Emil Clahr, Björkhamregatan 8 A, 82131 BOLLNÄS, SE
(30)	<b>Prioritet:</b>	2007.12.11 EM 000840277

(11)	<b>Reg.nr.:</b>	<b>081340</b>
(21)	<b>Søkn.nr.:</b>	20080286
(22)	<b>Inngitt:</b>	2008.05.20
(43)	<b>Allm. tilgj.:</b>	2008.05.20
(15)	<b>Registrert:</b>	2008.09.17
(45)	<b>Kunngjort:</b>	2008.10.06
(18)	<b>Reg. gjelder til:</b>	2013.05.20
(55)	<b>Avbildning(er):</b>	



(54)	<b>Produkt:</b>	Redningsutstyr for spedbarn til sjøs.
(51)	<b>Klasse:</b>	29-02
(73)	<b>Innehaver:</b>	Hilde Elisabeth Tallaksen, Oddansheia 1, 4513 MANDAL, NO
(72)	<b>Designer:</b>	Hilde Elisabeth Tallaksen, Oddansheia 1, 4513 MANDAL, NO
(60)	<b>Anmerkning:</b>	Designen er i farger.

- (11) **Reg.nr.:** 081341
- (21) **Søkn.nr.:** 20080281
- (22) **Inngitt:** 2008.05.15
- (43) **Allm. tilgj.:** 2008.05.23
- (15) **Registrert:** 2008.09.17
- (45) **Kunngjort:** 2008.10.06
- (18) **Reg. gjelder til:** 2013.05.15
- (55) **Avbildning(er):**

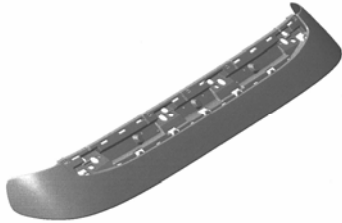

1.1



1.2



1.3



1.4



1.5



1.6



1.7

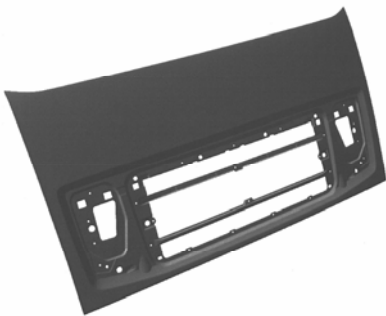

2.1

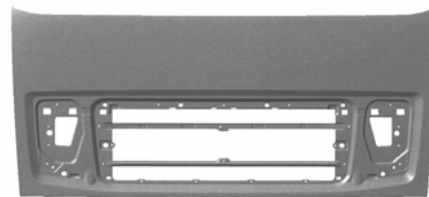

2.2

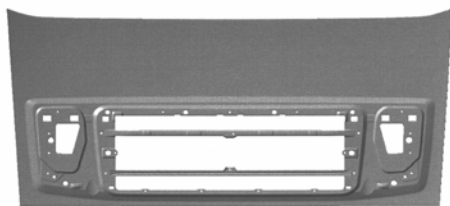

2.3



2.4

2.5



2.6



2.7

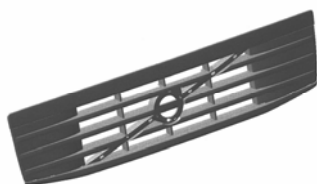

3.1

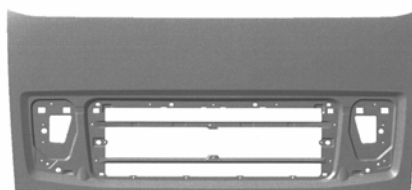

3.2





3.3



3.4



3.5



3.6



3.7

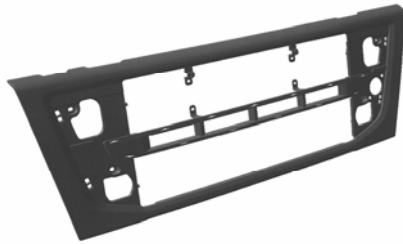

4.1

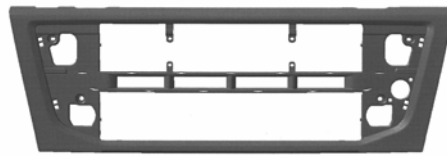

4.2



4.3



4.4



4.5



4.6



4.7

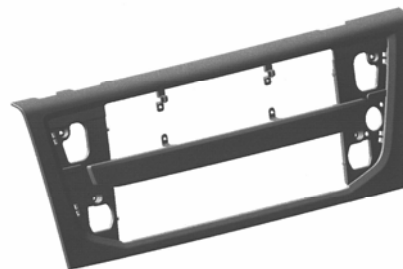

5.1

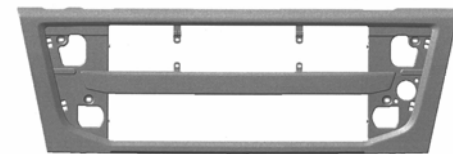

5.2

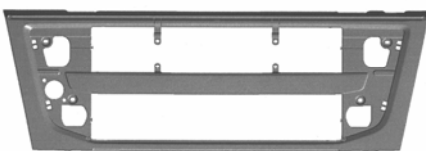

5.3



5.4



5.5



5.6



5.7

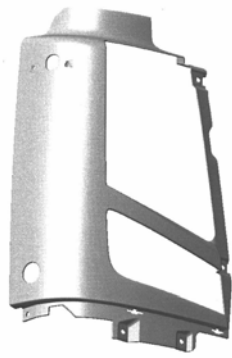

6.1

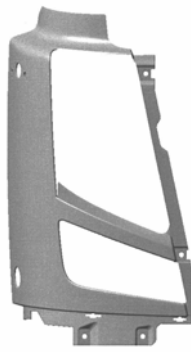

6.2

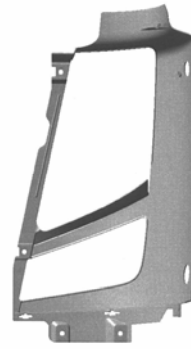

6.3



6.4

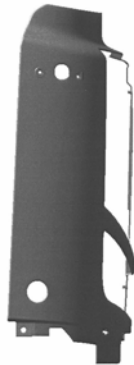

6.5



6.6



6.7

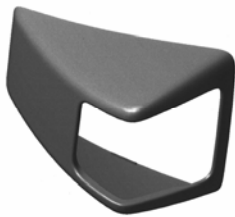

7.1



7.2



7.3



7.4



7.5



7.6



7.7

(74) **Fullmektig:**  
(54) **Produkt:**

Protector Intellectual Property Consultants AS, Postboks 5074 Majorstua, 0301 OSLO, NO

1. Solskjerm for kjøretøy
2. Frontlokk for kjøretøy
3. Grill for kjøretøy
4. Frontpanel med hull, for kjøretøy
5. Frontpanel uten hull, for kjøretøy
6. Hovedlampedeksel for kjøretøy
7. Retningslampedeksel for kjøretøy

(51) **Klasse:**

(73) **Innehaver:**

(72) **Designer:**

(30) **Prioritet:**

(60) **Anmerkning:**

1-7. 12-16

Volvo Lastvagnar AB, 40508 GÖTEBORG, SE

Asok George, Volvo 3p, Product Design, Dept. 26 800, Abn, 40508 GÖTEBORG, SE

2007.11.23 EM 000831656

Registreringen gjelder samregistrering.

(11)	<b>Reg.nr.:</b>	<b>081342</b>
(21)	<b>Søkn.nr.:</b>	20080282
(22)	<b>Inngitt:</b>	2008.05.15
(43)	<b>Allm. tilgj.:</b>	2008.05.23
(15)	<b>Registrert:</b>	2008.09.17
(45)	<b>Kunngjort:</b>	2008.10.06
(18)	<b>Reg. gjelder til:</b>	2013.05.15
(55)	<b>Avbildning(er):</b>	



1.1

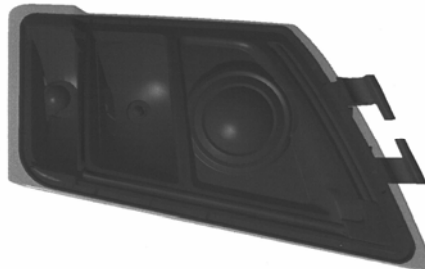

1.2

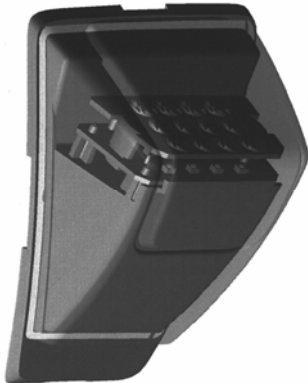

2.1



2.2



2.3

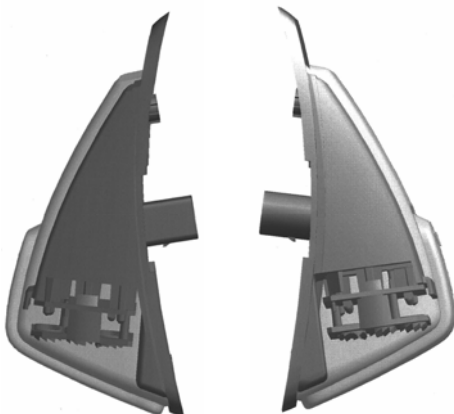

2.4

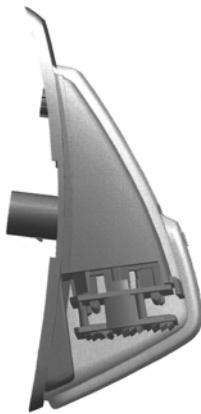

2.5



2.6

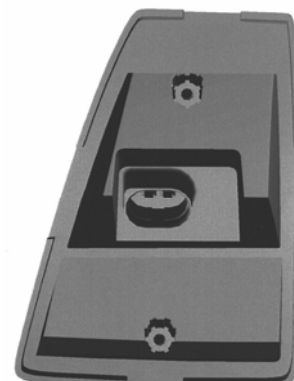

2.7



- (74) **Fullmektig:** Protector Intellectual Property Consultants AS, Postboks 5074 Majorstua, 0301 OSLO, NO  
 (54) **Produkt:** 1. Hovedlampe for kjøretøy  
 2. Retningslampe for kjøretøy  
 3. Lampeglass for kjøretøy
- (51) **Klasse:** 1-3. 26-06  
 (73) **Innehaver:** Volvo Lastvagnar AB, 40508 GÖTEBORG, SE  
 (72) **Designer:** Asok George, Volvo 3p, Product Design, Dept. 26 800, Abn, 40508 GÖTEBORG, SE  
 (30) **Prioritet:** 2007.11.23 EM 000831649  
 (60) **Anmerkning:** Registreringen gjelder samregistrering.

- (11) **Reg.nr.:** 081343  
 (21) **Søkn.nr.:** 20080287  
 (22) **Inngitt:** 2008.05.21  
 (43) **Allm. tilgj.:** 2008.05.22  
 (15) **Registrert:** 2008.09.17  
 (45) **Kunngjort:** 2008.10.06  
 (18) **Reg. gjelder til:** 2013.05.21  
 (55) **Avbildning(er):**

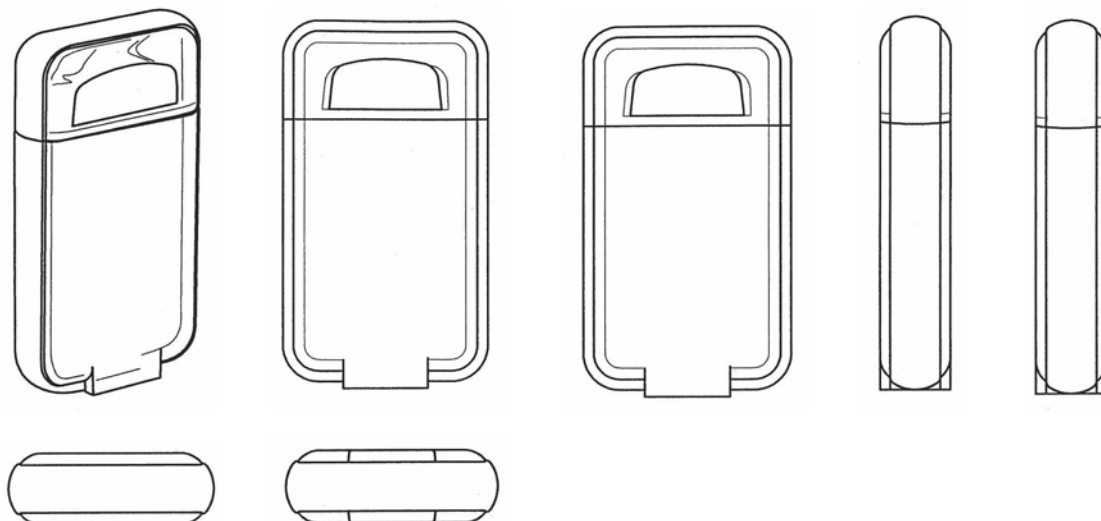

- (74) **Fullmektig:** Oslo Patentkontor AS, Postboks 7007 Majorstua, 0306 OSLO, NO  
 (54) **Produkt:** Flakong  
 (51) **Klasse:** 09-01  
 (73) **Innehaver:** Parfums Givenchy, 77, rue Anatole France, 92300 LEVALLOIS PERRET, FR  
 (72) **Designer:** Serge Mansau, 9 rue Georges Ville, 75116 PARIS, FR  
 (30) **Prioritet:** 2007.11.22 FR 07 5308

(11) **Reg.nr.:** 081344  
(21) **Søkn.nr.:** 20080293  
(22) **Inngitt:** 2008.05.27  
(43) **Allm. tilgj.:** 2008.05.29  
(15) **Registrert:** 2008.09.17  
(45) **Kunngjort:** 2008.10.06  
(18) **Reg. gjelder til:** 2013.05.27  
(55) **Avbildning(er):**

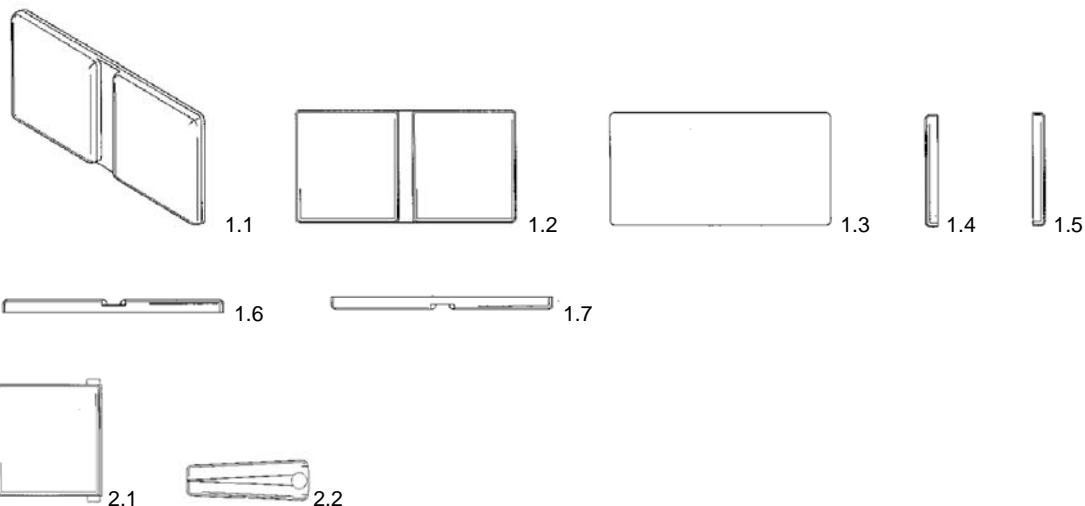

(74) **Fullmektig:** Bryn Aarflot AS, Postboks 449 Sentrum, 0104 OSLO, NO  
(54) **Produkt:** 1-2. Tåpute for fottøy  
(51) **Klasse:** 1-2. 02-04  
(73) **Innehaver:** LRC Products Ltd, 35 New Bridge Street, EC4V6BW LONDON, GB  
Pittsburgh Plastics Manufacturing Inc, 140 Kriess Road, PA16001 BUTLER, US  
Angela Parker, SSL International Plc, 35 New Bridge Street, EC4V6BW LONDON, GB  
(72) **Designer:** William Charles Gearheart, 274 Jessie Lane, PA15084 TARENTUM, US  
(30) **Prioritet:** 2007.11.29 EM 000837141  
(60) **Anmerknig:** Registreringen gjelder samregistrering.

(11) **Reg.nr.:** 081345  
(21) **Søkn.nr.:** 20080301  
(22) **Inngitt:** 2008.05.28  
(43) **Allm. tilgj.:** 2008.06.04  
(15) **Registrert:** 2008.09.18  
(45) **Kunngjort:** 2008.10.06  
(18) **Reg. gjelder til:** 2013.05.28  
(55) **Avbildning(er):**

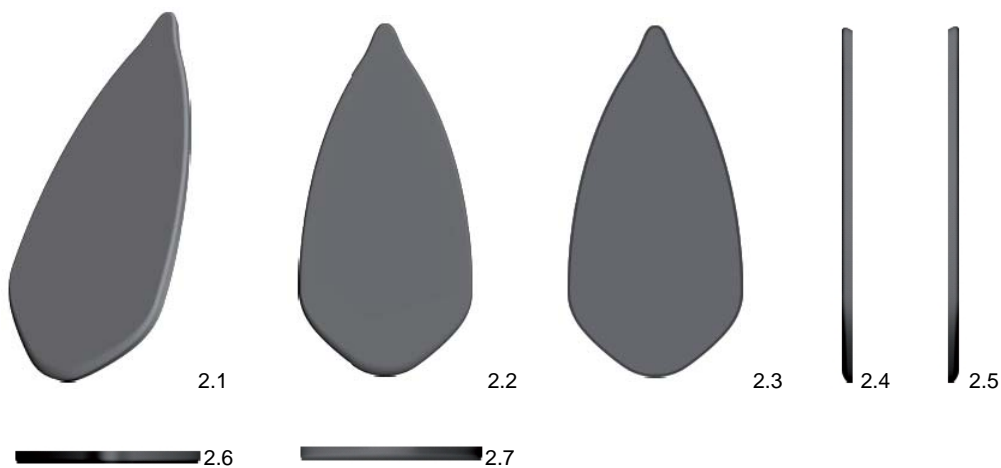
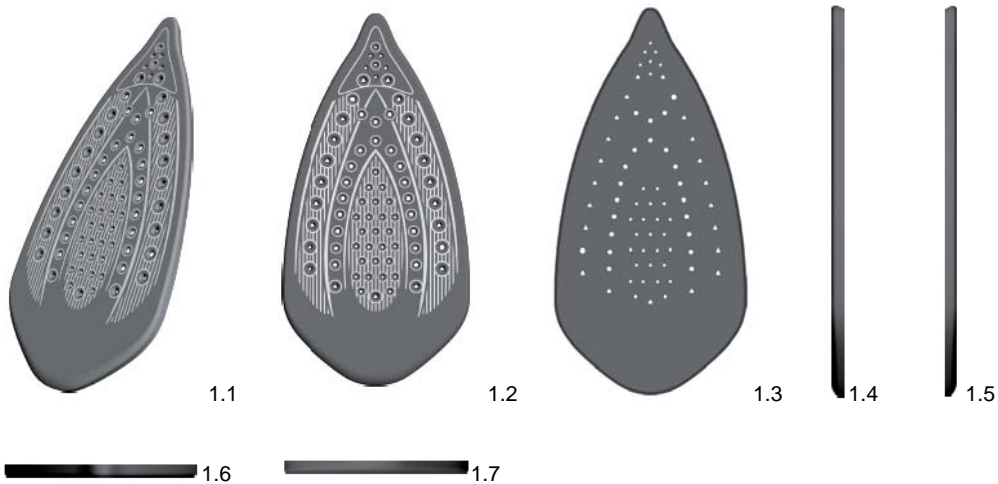

(74) **Fullmektig:** Protector Intellectual Property Consultants AS, Postboks 5074 Majorstua, 0301 OSLO, NO  
(54) **Produkt:** 1-2. Såleplate for strykejern  
(51) **Klasse:** 1-2. 07-05  
(73) **Innehaver:** Calor, Place Ambroise Courtois, 69008 LYON, FR  
(72) **Designer:** Dick Powell, Seymour-Powell, 327 Lillie Road, SW67NR LONDON, GB  
(30) **Prioritet:** 2007.12.04 FR 07 5490  
(60) **Anmerkning:** Registreringen gjelder samregistrering.

(11) **Reg.nr.:** 081346  
 (21) **Søkn.nr.:** 20080167  
 (22) **Inngitt:** 2008.03.11  
 (43) **Allm. tilgj.:** 2008.03.12  
 (15) **Registrert:** 2008.09.18  
 (45) **Kunngjort:** 2008.10.06  
 (18) **Reg. gjelder til:** 2013.03.11  
 (55) **Avbildning(er):**



1.1

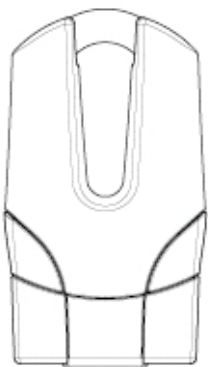

1.2

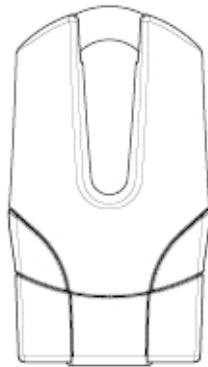

1.3



1.4



1.5

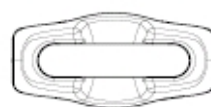

1.6

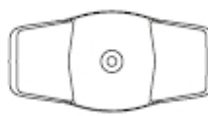

1.7



2.1



2.2



2.3



2.4



2.5



3.1



3.2



3.3



3.4



3.5

(74) **Fullmektig:** Protector Intellectual Property Consultants AS, Postboks 5074 Majorstua, 0301 OSLO, NO  
 (54) **Produkt:** 1-3. Lås  
 (51) **Klasse:** 1-3. 08-07  
 (73) **Innehaver:** ABUS August Bremicker Söhne KG, Altenhofer Weg 25, 58300 WETTER/VOLMARSTEIN, DE  
 (72) **Designer:** Winfried Buseman, Freiherr-vom-Stein Str. 20, 35745 HERBORN, DE  
 (30) **Prioritet:** 2007.09.12 EM 000795612  
 (60) **Anmerkning:** Design nr. 2 og 3 er i farger.  
 Registreringen gjelder samregistrering.  
 Det er foretatt supplerende undersøkelse.





Reg.nr: 075067 Fornyhet til: 2013.10.15  
Innehaver: Henkel KGaA, Henkelstrasse 67, 40589 DÜSSELDORF, DE  
Fullmektig: Zacco Norway AS, Postboks 2003 Vika, 0125 OSLO, NO

Reg.nr: 075194 Fornyhet til: 2013.09.14  
Innehaver: Harry Surland, Svaleveien 24, 3030 DRAMMEN, NO

Reg.nr: 075313 Fornyhet til: 2013.10.28  
Innehaver: Mul-T-Lock Technologies Ltd, P O Box 585, 81104 YAVNE, IL  
Fullmektig: Zacco Norway AS, Postboks 2003 Vika, 0125 OSLO, NO

Reg.nr: 075621 Fornyhet til: 2014.02.08  
Innehaver: Onoff AB, 19427 UPPLANDS VÄSBY, SE  
Fullmektig: Zacco Norway AS, Postboks 2003 Vika, 0125 OSLO, NO

Reg.nr: 075775 Fornyhet til: 2013.09.17  
Innehaver: Paroc Group OY AB, Neilikkatie 17, 01300 VANDA, FI  
Fullmektig: Oslo Patentkontor AS, Postboks 7007 Majorstua, 0306 OSLO, NO

Reg.nr: 075776 Fornyhet til: 2013.09.17  
Innehaver: Paroc Group OY AB, Neilikkatie 17, 01300 VANDA, FI  
Fullmektig: Oslo Patentkontor AS, Postboks 7007 Majorstua, 0306 OSLO, NO

Reg.nr: 077605 Fornyhet til: 2013.05.20  
Innehaver: Gull-Britt Ahl, Stockvägen 155, 54162 SKÖVDE, SE

Reg.nr: 077967 Fornyhet til: 2013.11.28  
Innehaver: FMC Kongsberg Subsea AS, Postboks 1012, 3601 Kongsberg, NO  
Fullmektig: Onsagers AS, Postboks 6963 St Olavs Plass, 0130 Oslo, NO

Reg.nr: 078001 Fornyhet til: 2013.10.08  
Innehaver: Sony Computer Entertainment Inc, 2-6-21, Minami-Aoyama, Minato-ku, 1007-0062 TOKYO, JP  
Fullmektig: Zacco Norway AS, Postboks 2003 Vika, 0125 OSLO, NO

Reg.nr: 078038 Fornyhet til: 2013.10.02  
Innehaver: Varco I/P Inc, 10000 Richmond Avenue, TX77042-4200 HOUSTON, US  
Fullmektig: Håmsø Patentbyrå ANS, Postboks 171, 4302 SANDNES, NO

Reg.nr: 078073 Fornyhet til: 2013.10.10  
Innehaver: Simon & Gaare Design AS, Auglendsdalen 81, 4017 Stavanger, NO  
Fullmektig:

Reg.nr: 078079 Fornyhet til: 2013.09.09  
Innehaver: Nibe AB, Box 134, 28523 MARKARYD, SE  
Fullmektig: Awapatent AB, Box 5117, 20071 MALMÖ, SE

Reg.nr: 078096 Fornyhet til: 2013.09.16  
Innehaver: Polyform US Ltd, 7030 South 224th, WA98032 KENT, US  
Fullmektig: Bryn Aarflot AS, Postboks 449 Sentrum, 0104 OSLO, NO

Reg.nr: 078113 Fornyhet til: 2013.09.26  
Innehaver: Pirelli Pneumatici SpA, Viale Sarca, 222, 20126 MILANO, IT  
Fullmektig: Tandbergs Patentkontor AS, Postboks 7085 Majorstua, 0306 OSLO, NO

Reg.nr: 078114 Fornyhet til: 2013.09.26  
Innehaver: Pirelli Pneumatici SpA, Viale Sarca, 222, 20126 MILANO, IT  
Fullmektig: Tandbergs Patentkontor AS, Postboks 7085 Majorstua, 0306 OSLO, NO

Reg.nr: 078162 Fornyhet til: 2013.09.19  
Innehaver: Filtoro AB, Tågås Torp 516, 66060 MOLKOM, SE  
Fullmektig: Hynell Patenttjänst AB, Patron Carls väg 2, 68340 HAGFORS/UDDEHOLM, SE

Reg.nr: 078293 Fornyhet til: 2013.10.06  
Innehaver: Henkel KGaA, 40191 DÜSSELDORF, DE  
Fullmektig: Zacco Norway AS, Postboks 2003 Vika, 0125 OSLO, NO

Reg.nr: 078338 Fornyhet til: 2013.07.01  
Innehaver: Kald Fisk AS, Øklandsvågen, 5430 Bremnes, NO

Reg.nr: 078431 Fornyhet til: 2013.11.20  
Innehaver: Société des Produits Nestlé SA, P.O. Box 353, 1800 VEVEY, CH  
Fullmektig: Zacco Norway AS, Postboks 2003 Vika, 0125 OSLO, NO

Reg.nr: 079397 Fornyhet til: 2013.08.07  
Innehaver: Quantronix Inc, 380 South 200 West, Farmington, UT94025-0929, US  
Fullmektig: Tandbergs Patentkontor AS, Postboks 7085 Majorstua, 0306 OSLO, NO