



PATENTSTYRET
Styret for det industrielle rettsvern

nr 22/06 - 2006.10.23 NO

årgang 4

ISSN 1503-5808

Norsk

design tidende

www.patentstyret.no

Norsk designtidende er en publikasjon som inneholder kunngjøringer innenfor designområdet

BESØKSADRESSE

- ▶ Københavngaten 10

POSTADRESSE

- ▶ Postboks 8160 Dep.
0033 Oslo

E-POST

- ▶ mail@patentstyret.no

TELEFON

- ▶ 22 38 73 00

TELEFAKS

- ▶ 22 38 73 01

INFOSENTERETS TELEFONTID

- ▶ kl. 09.00 - 15.00
Telefon (+47) 22 38 73 33
Telefaks (+47) 22 38 73 31

Innholdsfortegnelse:

Registrerte design	3
Fornyelser	61

INID-koder

I kunngjøringene er de enkelte data forsynt med koder overensstemmende med INID-kodesystemet

(INID= Internationally agreed Numbers for the Identification of Data).

- (11) Registreringsnummer
- (15) Registreringsdato
- (18) Dato som registreringen gjelder til
- (21) Søknadsnummer
- (22) Inngivelsesdato
- (30) Prioritetsopplysninger
- (43) Allment tilgjengelig dato
- (51) Klasse
- (54) Produkt
- (55) Avbildning(er)
- (72) Designer
- (73) Innehaver
- (74) Fullmektig

Registrerte design

I henhold til designloven § 18 første ledd i.f. kunngjøres i dag følgende registrerte design.

Det kan fremsettes krav om at designregistreringen helt eller delvis skal oppheves, jf. designloven §§ 25 flg. og designforskriften §§ 26 flg.

Designregistreringen gjelder for den eller de periodene på fem år som søknaden er innlevert for, regnet fra søknadsdagen. Registreringen kan fornyes, jf. designloven §§ 23 og 24. Maksimal beskyttelsestid er 25 år. For reservedeler, se unntaket i designloven § 23 annet ledd.

(11) Reg.nr.:	079893
(21) Søkn.nr.:	20060324
(22) Inngitt:	2006.06.22
(43) Allm. tilgj.:	2006.06.22
(15) Registrert:	2006.09.22
(45) Kunngjort:	2006.10.23
(18) Reg. gjelder til:	2011.06.22
(55) Avbildning(er):	



(74) Fullmektig:	Tandbergs Patentkontor AS, Postboks 7085 Majorstua, 0306 OSLO, NO
(54) Produkt:	Flaske
(51) Klasse:	09-01
(73) Innehaver:	HJ Heinz Co, 600 Grant Street, USX Tower 60th Floor, PA15219 PITTSBURGH, US
(72) Designer:	Wayne C Cleary, 1523 Bluestone Drive, PA15116 GLENSHAW, US
(30) Prioritet:	2005.12.22, US, 29/245,295

(11) **Reg.nr.:** 079894
(21) **Søkn.nr.:** 20060336
(22) **Inngitt:** 2006.06.27
(43) **Allm. tilgj.:** 2006.09.20
(15) **Registrert:** 2006.09.22
(45) **Kunngjort:** 2006.10.23
(18) **Reg. gjelder til:** 2011.06.27
(55) **Avbildning(er):**

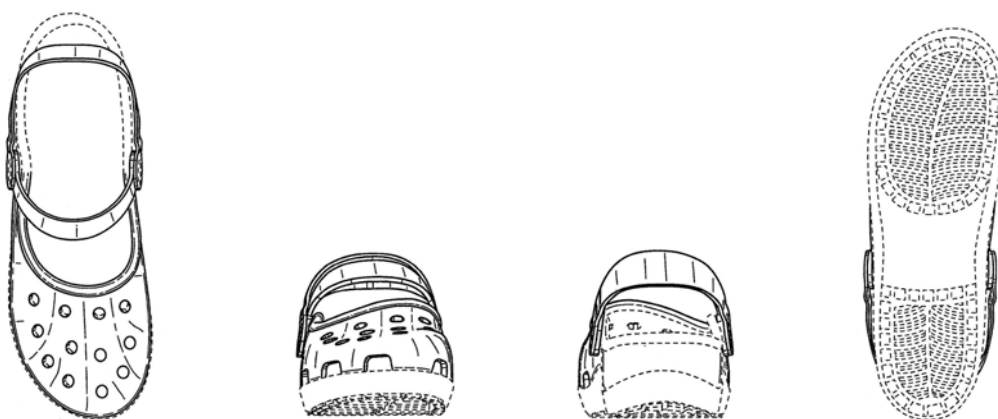
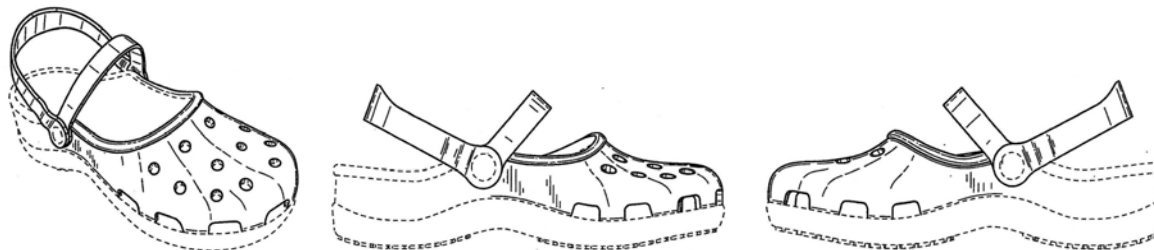

(74) **Fullmektig:** Bryn Aarflot AS, Postboks 449 Sentrum, 0104 OSLO, NO
(54) **Produkt:** Føttøy
(51) **Klasse:** 02-04
(73) **Innehaver:** Crocs Inc, 6273 Monarch Park Place, CO80503 NIWOT, US
(72) **Designer:** Scott Seamans, 7430 Clubhouse Road, CO80301 BOULDER, US
(30) **Prioritet:** 2006.03.20, US, 29/246,201

- (11) **Reg.nr.:** 079895
(21) **Søkn.nr.:** 20040586
(22) **Inngitt:** 2004.10.15
(43) **Allm. tilgj.:** 2004.10.21
(15) **Registrert:** 2006.09.22
(45) **Kunngjort:** 2006.10.23
(18) **Reg. gjelder til:** 2009.10.15
(55) **Avbildning(er):**



1.1

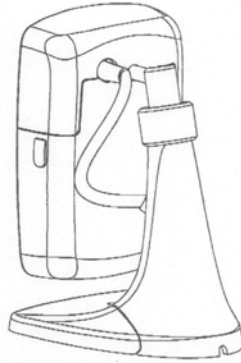

1.2



1.3

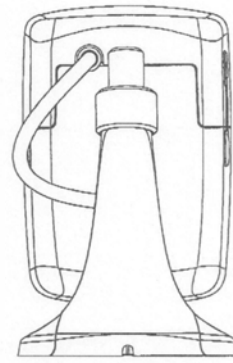

1.4

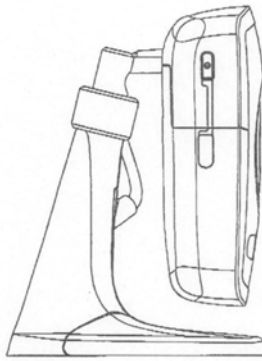

1.5

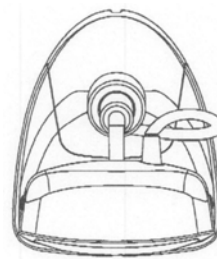

1.6



2.1

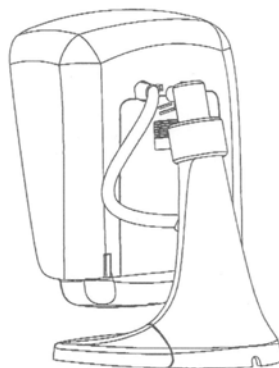

2.2

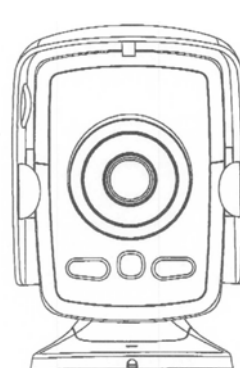

2.3

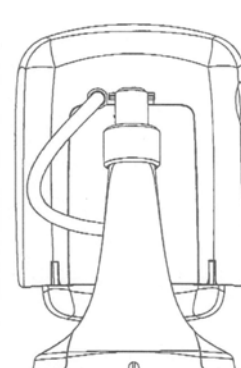

2.4

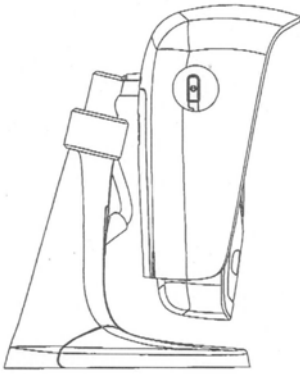

2.5

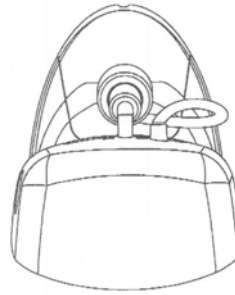

2.6

- (74) **Fullmektig:** Acapo AS, Postboks 1880 Nordnes, 5817 BERGEN, NO
(54) **Produkt:** 1-2. Observasjonsapparat
(51) **Klasse:** 1-2. 10-05
(73) **Innehaver:** Nokia Corporation, Keilalahdentie 4, 02150 ESBO, FI
(72) **Designer:** Matti Juhani Ruohanen, Piispankatu 6 D 40-41, 20500 ÅBO, FI
(30) **Prioritet:** 2004.04.21, FI, 20040067
(60) **Anmerkning:** Registreringen gjelder samregistrering.
-

- (11) **Reg.nr.:** 079896
- (21) **Søkn.nr.:** 20060305
- (22) **Inngitt:** 2006.06.13
- (43) **Allm. tilgj.:** 2006.06.14
- (15) **Registrert:** 2006.09.22
- (45) **Kunngjort:** 2006.10.23
- (18) **Reg. gjelder til:** 2011.06.13
- (55) **Avbildning(er):**



1.1



1.2



1.3



1.4



1.5



2.1



2.2



2.3



2.4



2.5



3.1



3.2



3.3



3.4



3.5



4.1



4.2



4.3



4.4



4.5



5.1



5.2



5.3

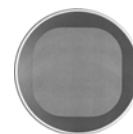

5.4

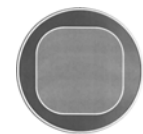

5.5



6.1



6.2



6.3



6.4



6.5

- (74) **Fullmektig:** Bryn Aarflot AS, Postboks 449 Sentrum, 0104 OSLO, NO
(54) **Produkt:** 1-6. Kopp
(51) **Klasse:** 1-6. 07-01
(73) **Innehaver:** Seda SpA, Corso Salvatore D'Amato 84, 80022 ARZANO NAPOLI, IT
(72) **Designer:** Gianfranco D'Amato, c/o Seda SpA, Corso Salvatore D'Amato 84, 80022 ARZANO NAPOLI, IT
(30) **Prioritet:** 2005.12.14, EM, 000447958
(60) **Anmerkning:** Registreringen gjelder samregistrering.
-

(11) **Reg.nr.:** 079897
 (21) **Søkn.nr.:** 20060189
 (22) **Inngitt:** 2006.04.12
 (43) **Allm. tilgj.:** 2006.04.18
 (15) **Registrert:** 2006.09.22
 (45) **Kunngjort:** 2006.10.23
 (18) **Reg. gjelder til:** 2011.04.12
 (55) **Avbildning(er):**

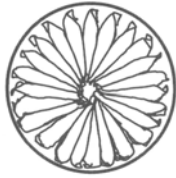

1.1



1.2



1.3



2.1

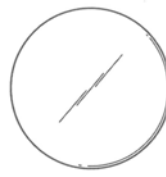

2.2



2.3



3.1

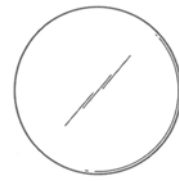

3.2



3.3



4.1

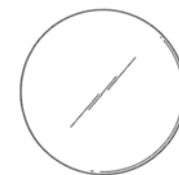

4.2



4.3



5.1

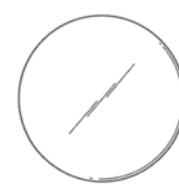

5.2



5.3

(74) **Fullmektig:** Zacco Norway AS, Postboks 2003 Vika, 0125 OSLO, NO
 (54) **Produkt:** 1-5. Snusdåse med porsjonssnus
 (51) **Klasse:** 1-5. 27-01, 27-06
 (73) **Innehaver:** Swedish Match North Europe AB, 11885 STOCKHOLM, SE
 (72) **Designer:** Anna Neiås, c/o Swedish Match North Europe AB, 11885 STOCKHOLM, SE
 (30) **Prioritet:** 2005.10.18, SE, 050618
 (60) **Anmerkning:** Registreringen gjelder samregistrering.

(11) **Reg.nr.:** 079898
 (21) **Søkn.nr.:** 20060226
 (22) **Inngitt:** 2006.05.04
 (43) **Allm. tilgj.:** 2006.09.21
 (15) **Registrert:** 2006.09.22
 (45) **Kunngjort:** 2006.10.23
 (18) **Reg. gjelder til:** 2011.05.04
 (55) **Avbildning(er):**

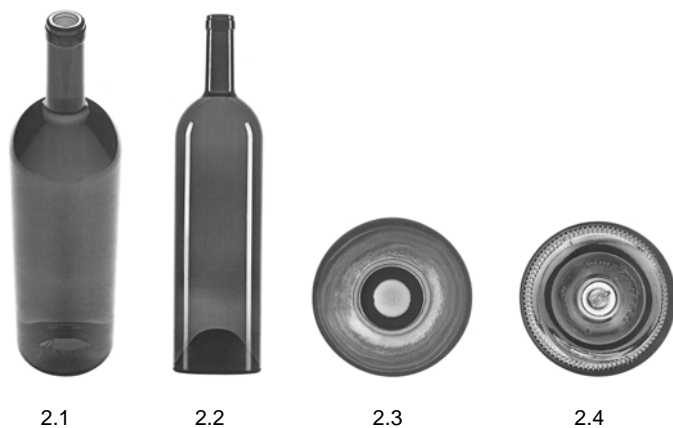

(74) **Fullmektig:** JK Thorsens Patentbureau AS, Postboks 9276 Grønland, 0134 OSLO, NO
 (54) **Produkt:** 1-2. Flaske
 (51) **Klasse:** 1-2. 09-01
 (73) **Innehaver:** Societe Autonome De Verreries, Place de la Gare, 60960 FEUQUIERES, FR
 (72) **Designer:** Didier Rica, 152, in the rue Haute, 60650 LE MONT SAINT ADRIEN, FR
 (30) **Prioritet:** 2006.03.21, EM, 000498878
 (60) **Anmerking:** Registreringen gjelder en samregistrering.

(11) **Reg.nr.:** 079899
(21) **Søkn.nr.:** 20060118
(22) **Inngitt:** 2006.03.02
(43) **Allm. tilgj.:** 2006.03.02
(15) **Registrert:** 2006.09.22
(45) **Kunngjort:** 2006.10.23
(18) **Reg. gjelder til:** 2011.03.02
(55) **Avbildning(er):**



1.1



1.2



1.3

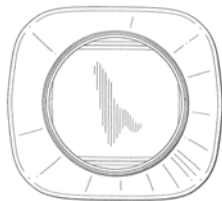

1.4



1.5



2.1

(74) **Fullmektig:** Zacco Norway AS, Postboks 2003 Vika, 0125 OSLO, NO
(54) **Produkt:** 1. Flaske
2. Flaske med lokk
(51) **Klasse:** 1-2. 09-01
(73) **Innehaver:** Unilever NV, Weena 455, 3013AL ROTTERDAM, NL
(72) **Designer:** Lisa Marie Langbein, 23314 Allen Robert Drive, IL69544 PLAINFIELD, US
Brent William Lindberg, 2704 Royal Kings Ct, IL60175 SAINT CHARLES, US
(30) **Prioritet:** 2005.09.02, US, 29/237,615
(60) **Anmerkning:** Registreringen gjelder samregistrering.

(11) **Reg.nr.:** 079900
(21) **Søkn.nr.:** 20060351
(22) **Inngitt:** 2006.06.30
(43) **Allm. tilgj.:** 2006.07.11
(15) **Registrert:** 2006.09.22
(45) **Kunngjort:** 2006.10.23
(18) **Reg. gjelder til:** 2011.06.30
(55) **Avbildning(er):**

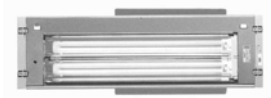

(74) **Fullmektig:** Zacco Norway AS, Postboks 2003 Vika, 0125 OSLO, NO
(54) **Produkt:** Lampe
(51) **Klasse:** 26-03
(73) **Innehaver:** Herbert Waldmann GmbH & Co KG, Peter-Henlein-Strasse 5, 78056 VILLINGEN-SCHWENNINGEN, DE
(72) **Designer:** Gerhard Waldmann, Lembergstrasse 7, 78083 DAUCHINGEN, DE
(30) **Prioritet:** 2006.01.11, DE, 406 00 171

(11) **Reg.nr.:** 079901
 (21) **Søkn.nr.:** 20060306
 (22) **Inngitt:** 2006.06.14
 (43) **Allm. tilgj.:** 2006.07.16
 (15) **Registrert:** 2006.09.22
 (45) **Kunngjort:** 2006.10.23
 (18) **Reg. gjelder til:** 2011.06.14
 (55) **Avbildning(er):**



Tversnitt

(74) **Fullmektig:** Acapo AS, Postboks 1880 Nordnes, 5817 BERGEN, NO
 (54) **Produkt:** Tidsur
 (51) **Klasse:** 10-03
 (73) **Innehaver:** PI-Design AG, Postfach 463, 6234 TRIENGEN, CH
 (72) **Designer:** Jørgen Bodum, St Niklausenstrasse 23, 6005 ST NIKLAUSEN, CH
 (30) **Prioritet:** 2006.01.16, DK, 2006 00016

(11) **Reg.nr.:** 079902
 (21) **Søkn.nr.:** 20060083
 (22) **Inngitt:** 2006.02.08
 (43) **Allm. tilgj.:** 2006.05.23
 (15) **Registrert:** 2006.09.25
 (45) **Kunngjort:** 2006.10.23
 (18) **Reg. gjelder til:** 2011.02.08
 (55) **Avbildning(er):**

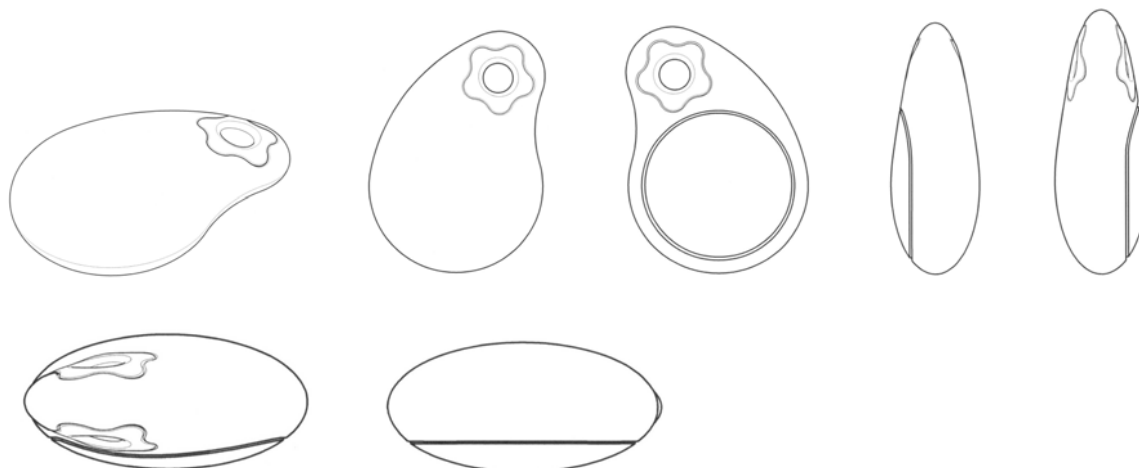

(74) **Fullmektig:** Bryn Aarflot AS, Postboks 449 Sentrum, 0104 OSLO, NO
 (54) **Produkt:** Del av tyverialarm
 (51) **Klasse:** 10-05
 (73) **Innehaver:** Securitas Direct AB, Box 2511, 58002 LINKÖPING, SE
 (72) **Designer:** Dave Schaecken, Emmasingel 24, 5600MD EINDHOVEN, NL
 Alain Huvet, c/o Village d'Entreprises, BP 41, 06901 SOPHIA ANTIPOLIS CEDEX, FR
 (30) **Prioritet:** 2005.11.23, US, 29/243,322

- (11) **Reg.nr.:** 079903
- (21) **Søkn.nr.:** 20060213
- (22) **Inngitt:** 2006.04.27
- (43) **Allm. tilgj.:** 2006.04.28
- (15) **Registrert:** 2006.09.25
- (45) **Kunngjort:** 2006.10.23
- (18) **Reg. gjelder til:** 2011.04.27
- (55) **Avbildning(er):**

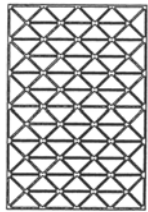

1.1

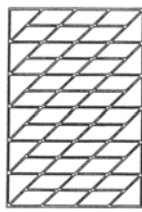

2.1

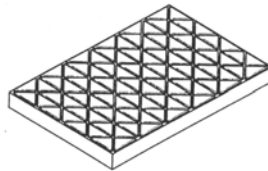

3.1

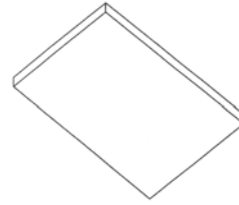

3.2

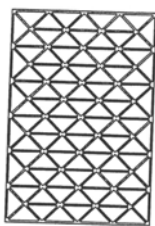

3.3



3.4



3.5

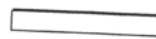

3.6

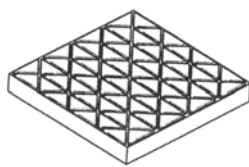

4.1

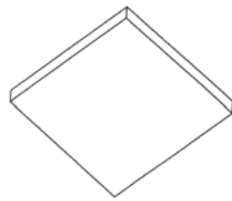

4.2

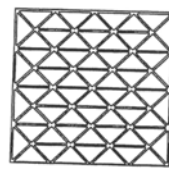

4.3



4.4



4.5

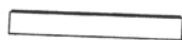

4.6

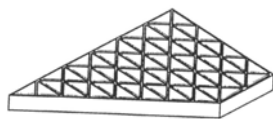

5.1

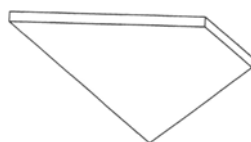

5.2

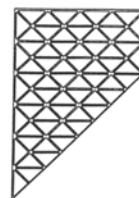

5.3



5.4



5.5



5.6

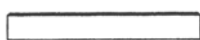

5.7

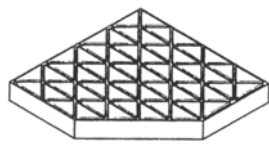

6.1

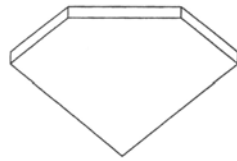

6.2

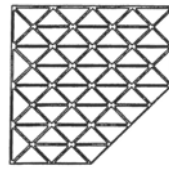

6.3

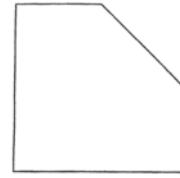

6.4



6.5

6.6

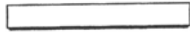

6.7

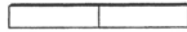

6.8

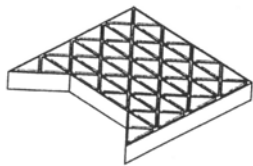

7.1

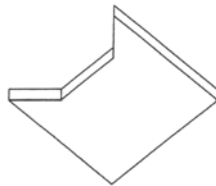

7.2

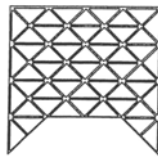

7.3

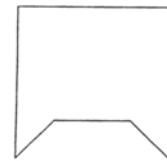

7.4



7.5

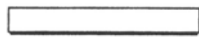

7.6

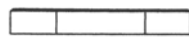

7.7

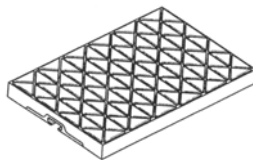

8.1

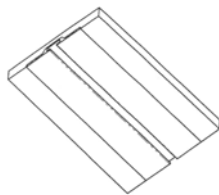

8.2



8.3

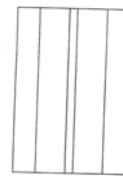

8.4



8.5



8.6

- (74) **Fullmektig:** Bryn Aarflot AS, Postboks 449 Sentrum, 0104 OSLO, NO
 (54) **Produkt:** 1-8. Keramisk sliteplate
 (51) **Klasse:** 1-8. 15-99
 (73) **Innehaver:** Sandvik Intellectual Property AB, 81181 SANDVIKEN, SE
 (72) **Designer:** Mats Malmberg, Tonebro Solberga 1244, 27463 RYDSGÅRD, SE
 (30) **Prioritet:** 2005.10.28, SE, 05-0641
 (60) **Anmerkning:** Registreringen gjelder samregistrering.

(11) **Reg.nr.:** 079904
(21) **Søkn.nr.:** 20060307
(22) **Inngitt:** 2006.06.14
(43) **Allm. tilgj.:** 2006.06.16
(15) **Registrert:** 2006.09.25
(45) **Kunngjort:** 2006.10.23
(18) **Reg. gjelder til:** 2011.06.14
(55) **Avbildning(er):**

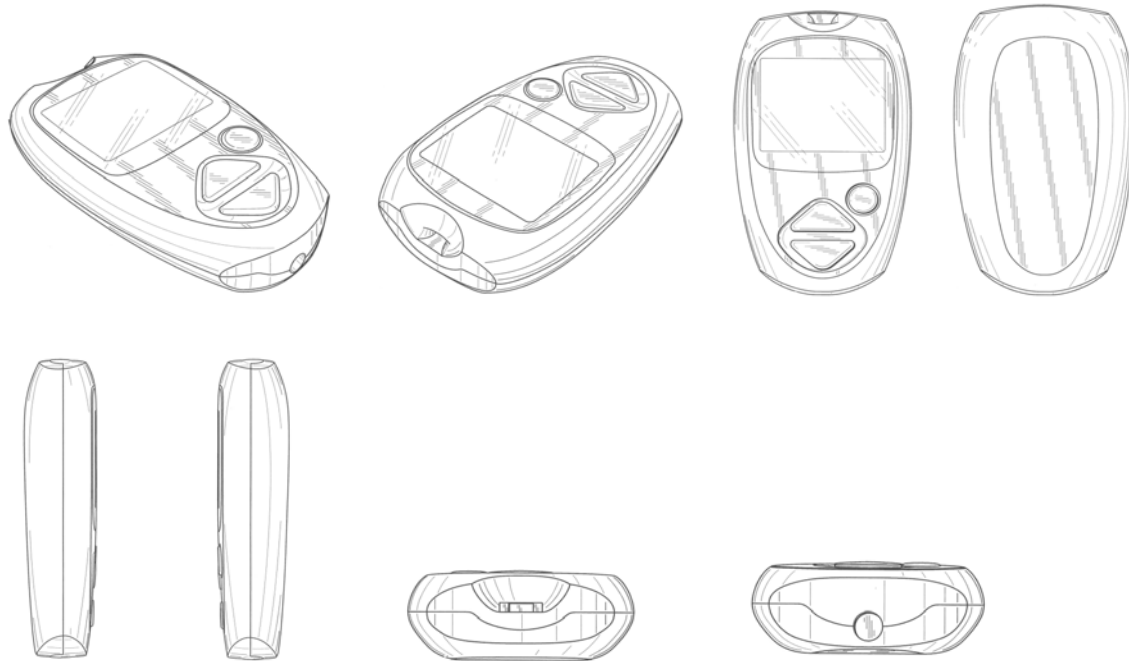

(74) **Fullmektig:** Zacco Norway AS, Postboks 2003 Vika, 0125 OSLO, NO
(54) **Produkt:** Analytt-testmåler
(51) **Klasse:** 24-02
(73) **Innehaver:** LifeScan Inc, 1000 Gibraltar Drive, MS 3 D, CA95035-6312 MILPITAS, US
(72) **Designer:** Michael Voege, Corwin Street, Apt 2, CA94114 SAN FRANCISCO, US
(30) **Prioritet:** 2005.12.16, US, 29/245,055

(11) **Reg.nr.:** 079905
(21) **Søkn.nr.:** 20060308
(22) **Inngitt:** 2006.06.14
(43) **Allm. tilgj.:** 2006.06.15
(15) **Registrert:** 2006.09.25
(45) **Kunngjort:** 2006.10.23
(18) **Reg. gjelder til:** 2011.06.14
(55) **Avbildning(er):**

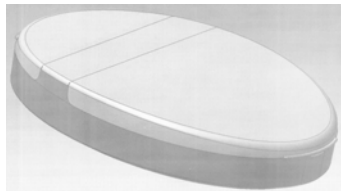

1.1

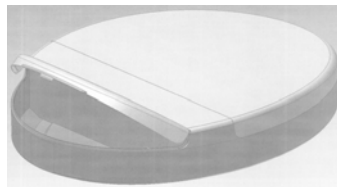

1.2

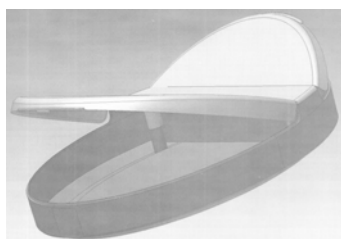

1.3

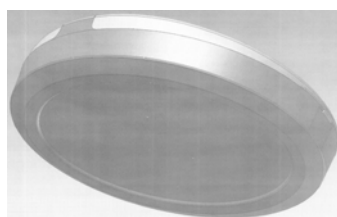

1.4



2.1

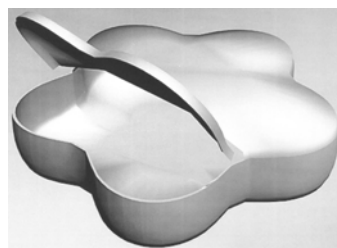

2.2

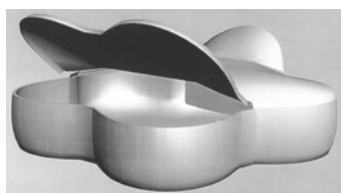

2.3

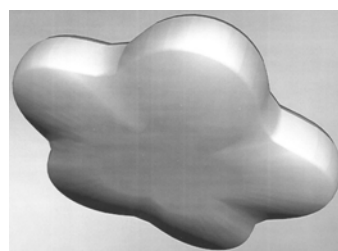

2.4

(74) **Fullmektig:** Plougmann & Vingtoft, Postboks 1003 Sentrum, 0104 OSLO, NO
(54) **Produkt:** 1-2. Snusdåse
(51) **Klasse:** 1-2. 27-06
(73) **Innehaver:** Njette AB, Slettvägen 5, 26041 NYHAMNSLÄGE, SE
(72) **Designer:** Ann-Marie Ostrenius, Spårögatan 41, 25732 RYDEBÄCK, SE
(30) **Prioritet:** 2005.12.15, SE, 050750
(60) **Anmerkning:** Registreringen gjelder samregistrering.

(11) **Reg.nr.:** 079906
(21) **Søkn.nr.:** 20060081
(22) **Inngitt:** 2006.02.07
(43) **Allm. tilgj.:** 2006.02.09
(15) **Registrert:** 2006.09.26
(45) **Kunngjort:** 2006.10.23
(18) **Reg. gjelder til:** 2011.02.07
(55) **Avbildning(er):**

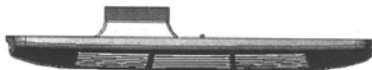
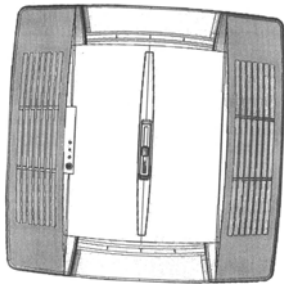
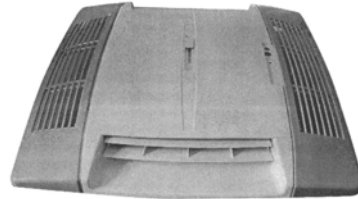
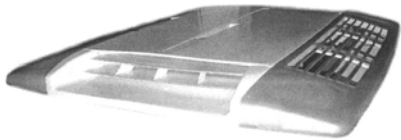

(74) **Fullmektig:** Plougmann & Vingtoft, Postboks 1003 Sentrum, 0104 OSLO, NO
(54) **Produkt:** Luftspreder
(51) **Klasse:** 23-04
(73) **Innehaver:** Dometic Wta Srl, Via Virgilio N 3, 47100 FORLI, IT
(72) **Designer:** Enrico Paci, c/o Dometic Wta Srl, Via Virgilio N 3, 47100 FORLI, IT
(30) **Prioritet:** 2005.08.09, EM, 000385422

- (11) **Reg.nr.:** 079907
(21) **Søkn.nr.:** 20060364
(22) **Inngitt:** 2006.07.07
(43) **Allm. tilgj.:** 2006.08.09
(15) **Registrert:** 2006.09.26
(45) **Kunngjort:** 2006.10.23
(18) **Reg. gjelder til:** 2011.07.07
(55) **Avbildning(er):**

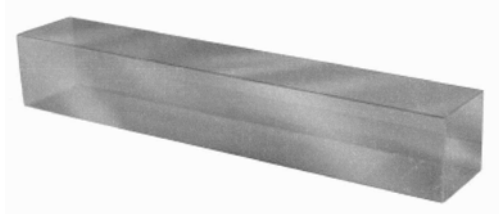

1.1

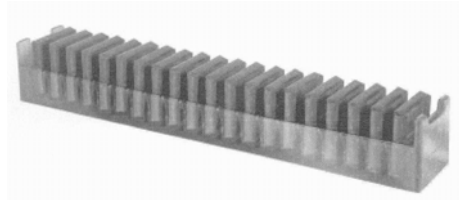

2.1

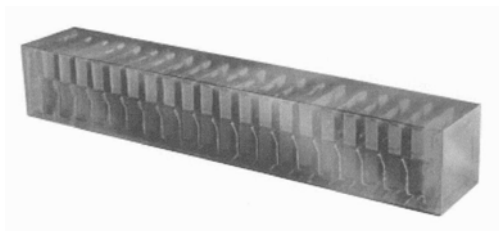

3.1

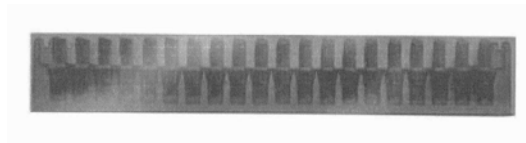

3.2

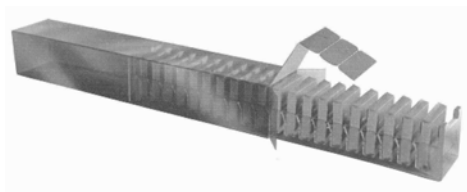

3.3

- (74) **Fullmektig:** Zacco Norway AS, Postboks 2003 Vika, 0125 OSLO, NO
(54) **Produkt:** 1. Eske
2. Innsats til eske
3. Eske med innsats
(51) **Klasse:** 1-3. 09-03
(73) **Innehaver:** Société Produits Nestlé SA, Avenue Nestlé 55, 1800 VEVEY, CH
(72) **Designer:** Jean Nouvel, 10, Cité d'Angouleme PARIS, FR
(30) **Prioritet:** 2006.02.09, CH, 132516
(60) **Anmerkning:** Registreringen gjelder samregistrering.

(11) Reg.nr.:	079908
(21) Søkn.nr.:	20060340
(22) Inngitt:	2006.06.29
(43) Allm. tilgj.:	2006.09.27
(15) Registrert:	2006.09.27
(45) Kunngjort:	2006.10.23
(18) Reg. gjelder til:	2011.06.29
(55) Avbildning(er):	



1.1



2.1

-(54) Produkt:	1. Varmepakning for skulder og nakke 2. Kuldepakning/gelpakning for skulder og nakke
(51) Klasse:	24-04
(73) Innehaver:	Softonus, Postboks 27, 4291 KOPERVIK, NO
(72) Designer:	Ccd AS, Postboks 111, 4339 ÅLGÅRD, NO
(60) Anmerkning:	Registreringen gjelder samregistrering.

- (11) **Reg.nr.:** 079909
- (21) **Søkn.nr.:** 20060327
- (22) **Inngitt:** 2006.06.23
- (43) **Allm. tilgj.:** 2006.06.23
- (15) **Registrert:** 2006.09.27
- (45) **Kunngjort:** 2006.10.23
- (18) **Reg. gjelder til:** 2011.06.23
- (55) **Avbildning(er):**

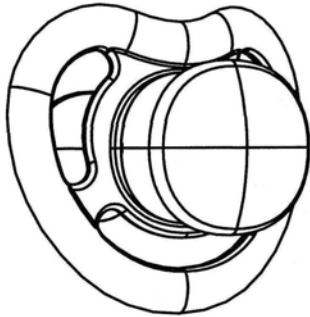

1.1

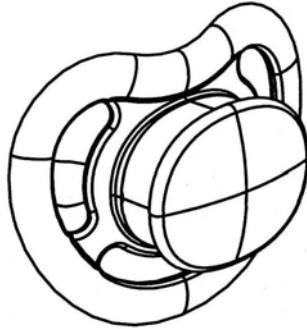

1.2

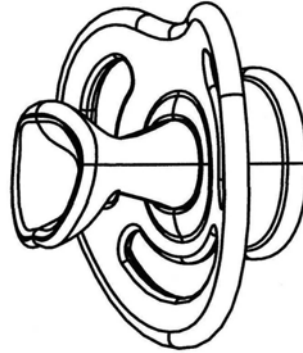

1.3

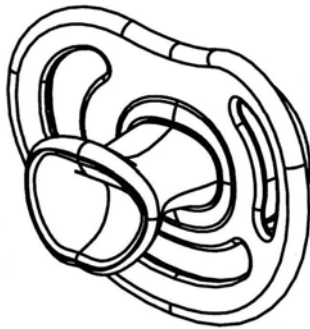

1.4

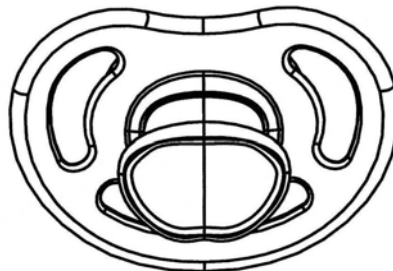

1.5

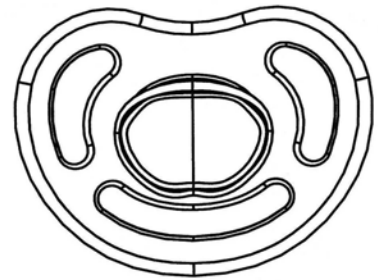

1.6

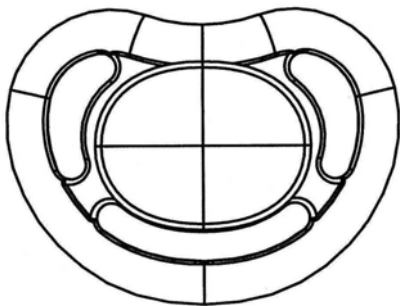

1.7

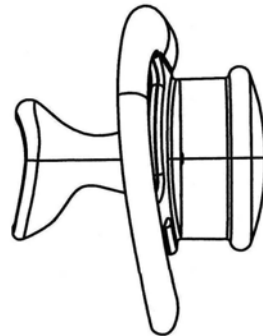

1.8

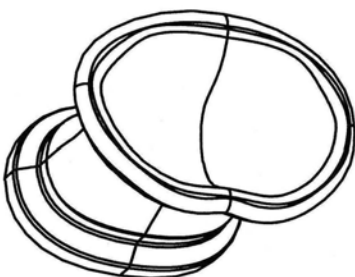

2.1

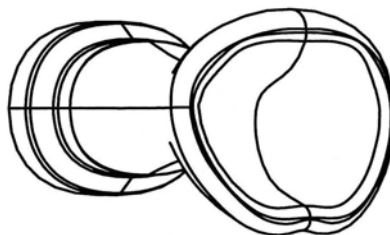

2.2

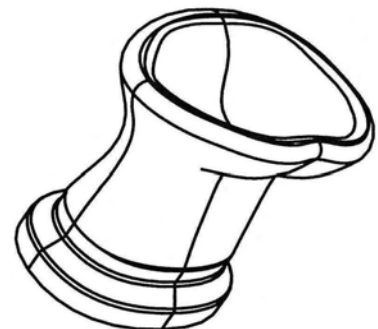

2.3

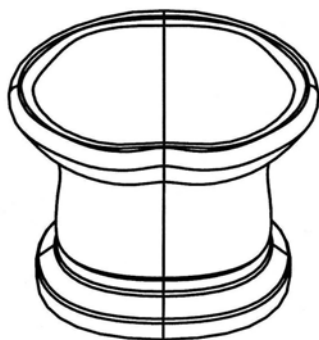

2.4

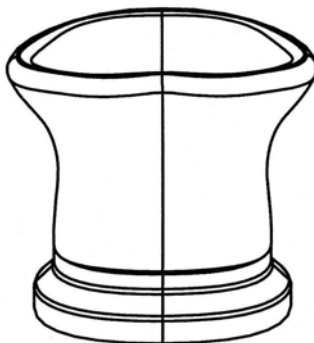

2.5



2.6

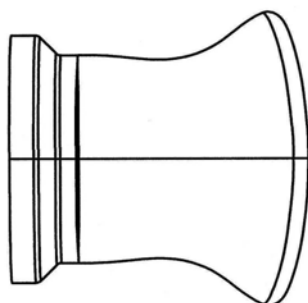

2.7

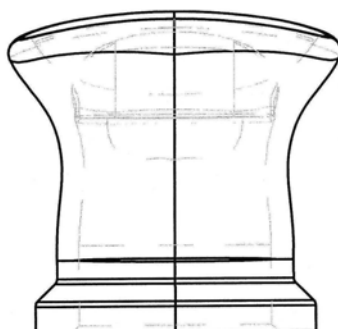

2.8

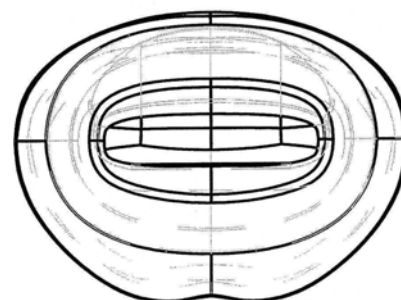

2.9

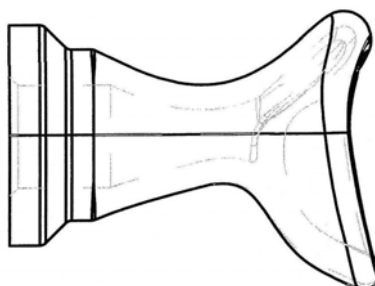

2.10

- (74) **Fullmektig:** Håmsø Patentbyrå ANS, Postboks 171, 4302 SANDNES, NO
 (54) **Produkt:** 1. Narresmökk
 2. Sugedel til narresmökk
 (51) **Klasse:** 1-2. 24-04
 (73) **Innehaver:** Orthodoxent AS, LIV-bygget, 7125 VANVIKAN, NO
 (72) **Designer:** Reza Hezari, c/o SurgiTech Norway AS, Borchgrevinkvei 5, 7020 TRONDHEIM, NO
 Terje S Pedersen, Giskegata 2 A, 4317 SANDNES, NO
 Bodil Opshaug, Trenerys gate 4, 7042 TRONDHEIM, NO
 (60) **Anmerkning:** Registreringen gjelder samregistrering.

(11) **Reg.nr.:** 079910
 (21) **Søkn.nr.:** 20050654
 (22) **Inngitt:** 2005.11.10
 (43) **Allm. tilgj.:** 2005.11.11
 (15) **Registrert:** 2006.09.27
 (45) **Kunngjort:** 2006.10.23
 (18) **Reg. gjelder til:** 2010.11.10
 (55) **Avbildning(er):**



1.1

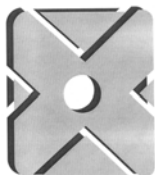

2.1



3.1

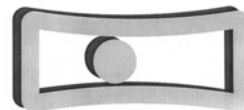

4.1

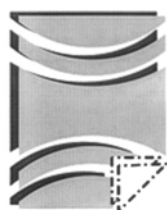

5.1

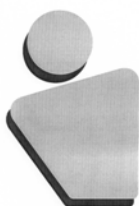

6.1



7.1



8.1

(74) **Fullmektig:** Bryn Aarflot AS, Postboks 449 Sentrum, 0104 OSLO, NO
 (54) **Produkt:** 1-8. Ikon for fremvisningsskjerm
 (51) **Klasse:** 1-8. 14-04
 (73) **Innehaver:** Microsoft Corp, One Microsoft Way, WA98052-6399 REDMOND, US
 (72) **Designer:** Shelley Armstrong, c/o Microsoft Corp, One Microsoft Way, WA98052 REDMOND, US
 Corey Marion, c/o The Iconfactory, 7204 West Friendly Ave, Bldg 2, Unit F, NC27410-6211 GREENSBORO, US
 David Lanham, c/o The Iconfactory, 7204 West Friendly Ave, Bldg 2, Unit F, NC27410-6211 GREENSBORO, US
 Travis Zuker, c/o The Iconfactory, 7204 West Friendly Ave, Bldg 2, Unit F, NC27410-6211 GREENSBORO, US
 Nino Yuniardi, c/o Microsoft Corp, One Microsoft Way, WA98052 REDMOND, US
 (30) **Prioritet:** 2005.05.11, US, 29/229,687 (design nr. 1)
 2005.05.11, US, 29/229,688 (design nr. 2)
 2005.05.11, US, 29/229,689 (design nr. 3)
 2005.05.11, US, 29/229,690 (design nr. 4)
 2005.05.11, US, 29/229,691 (design nr. 5)
 2005.05.11, US, 29/229,692 (design nr. 6)
 2005.05.11, US, 29/229,693 (design nr. 7)
 2005.05.11, US, 29/229,694 (design nr. 8)
 (60) **Anmerkning:** Registreringen gjelder samregistrering.

(11) **Reg.nr.:** 079911
 (21) **Søkn.nr.:** 20060179
 (22) **Inngitt:** 2006.04.07
 (43) **Allm. tilgj.:** 2006.04.07
 (15) **Registrert:** 2006.09.27
 (45) **Kunngjort:** 2006.10.23
 (18) **Reg. gjelder til:** 2011.04.07
 (55) **Avbildning(er):**



1.1

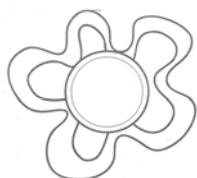

2.1

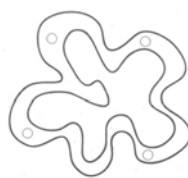

2.2



2.3

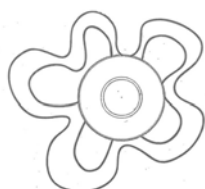

3.1



3.2

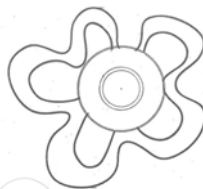

4.1



4.2

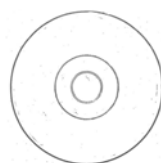

5.1



5.2

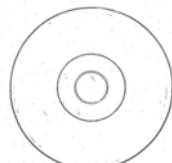

6.1

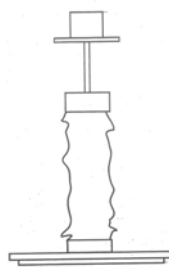

6.2



7.1

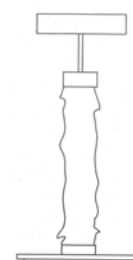

7.2

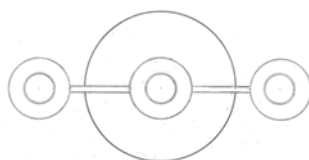

8.1

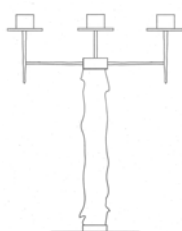

8.2

(74) **Fullmektig:** Protector Intellectual Property Consultants AS, Postboks 5074 Majorstua, 0301 OSLO, NO
 (54) **Produkt:** 1. Lyslykt
 2. Telysholder
 3-6. Kronestake
 7. Kubbelysstake
 8. Kronestake
 (51) **Klasse:** 1-8. 26-01
 (73) **Innehaver:** J Tveits Smie AS, 2647 SØR-FRON, NO
 (72) **Designer:** Hedda Heyerdahl Braathen, Sørkedalen 944, 0759 OSLO, NO
 (60) **Anmerking:** Registreringen gjelder samregistrering.

(11) **Reg.nr.:** 079912
 (21) **Søkn.nr.:** 20060096
 (22) **Inngitt:** 2006.02.17
 (43) **Allm. tilgj.:** 2006.03.12
 (15) **Registrert:** 2006.09.27
 (45) **Kunngjort:** 2006.10.23
 (18) **Reg. gjelder til:** 2011.02.17
 (55) **Avbildning(er):**

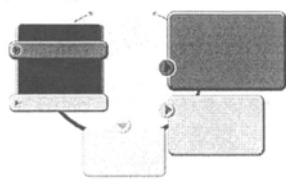

1.1

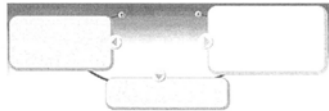

2.1



3.1

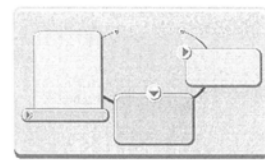

4.1

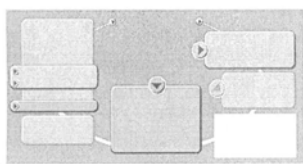

5.1

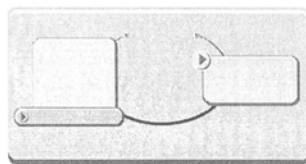

6.1

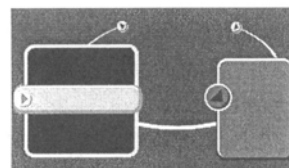

7.1

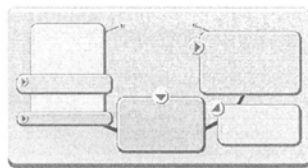

8.1

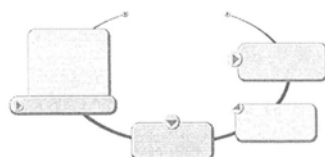

9.1

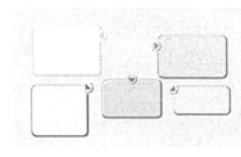

10.1

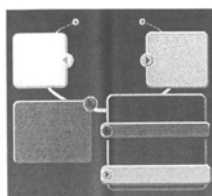

11.1

(74) **Fullmektig:** Zacco Norway AS, Postboks 2003 Vika, 0125 OSLO, NO
 (54) **Produkt:** 1-11. Trykksak
 (51) **Klasse:** 1-11. 19-08
 (73) **Innehaver:** Société des Produits Nestlé SA, Case postale 353, 1800 VEVEY, CH
 (72) **Designer:** Philippe Delmotte, 63 rue Soeur Angèle, 95210 ST GRATIEN, FR
 Marc Bourges, 41 rue de la Chappelle, 75018 PARIS, FR
 (30) **Prioritet:** 2005.09.12, EM, 000398763
 (60) **Anmerking:** Registreringen gjelder samregistrering.

- (11) **Reg.nr.:** 079913
 (21) **Søkn.nr.:** 20060080
 (22) **Inngitt:** 2006.02.07
 (43) **Allm. tilgj.:** 2006.08.07
 (15) **Registrert:** 2006.09.27
 (45) **Kunngjort:** 2006.10.23
 (18) **Reg. gjelder til:** 2011.02.07
 (55) **Avbildning(er):**



- (74) **Fullmektig:** Zacco Norway AS, Postboks 2003 Vika, 0125 OSLO, NO
 (54) **Produkt:** Frierring
 (51) **Klasse:** 11-01
 (73) **Innehaver:** Panorama AS, Serviceboks 750, 4809 ARENDAL, NO
 (72) **Designer:** Hilde Holthe Lunder, Sandvigsv. 19, 4816 KOLBJØRNSVIK, NO

- (11) **Reg.nr.:** 079914
 (21) **Søkn.nr.:** 20060079
 (22) **Inngitt:** 2006.02.07
 (43) **Allm. tilgj.:** 2006.07.10
 (15) **Registrert:** 2006.09.27
 (45) **Kunngjort:** 2006.10.23
 (18) **Reg. gjelder til:** 2011.02.07
 (55) **Avbildning(er):**

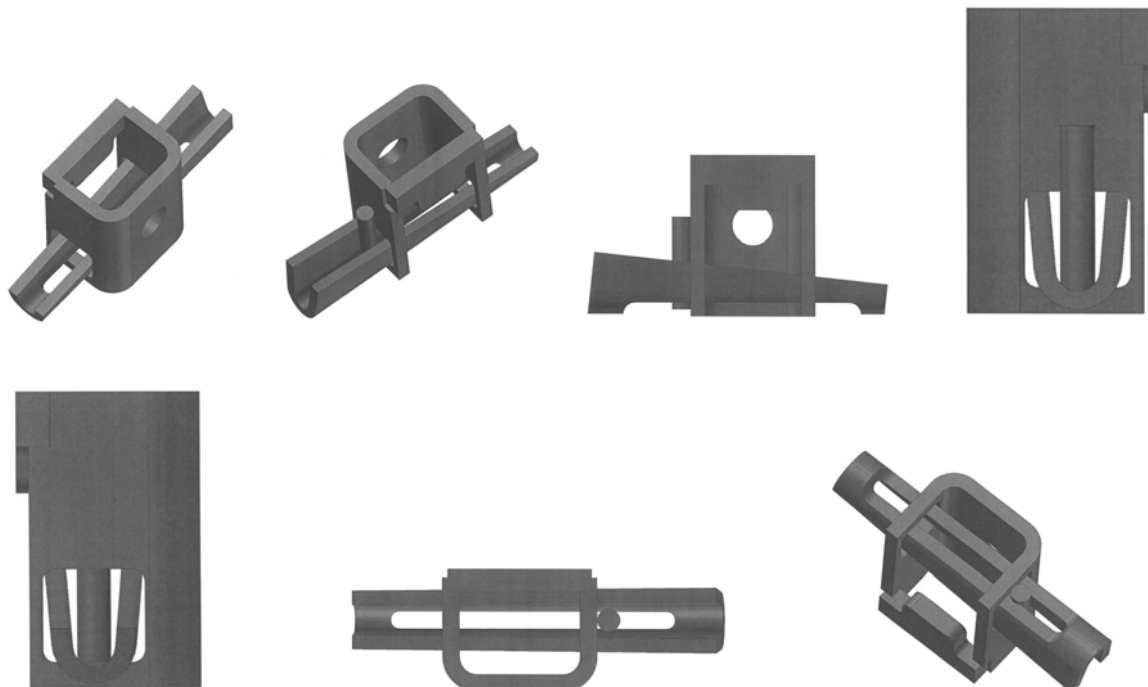

- (74) **Fullmektig:** Bryn Aarflot AS, Postboks 449 Sentrum, 0104 OSLO, NO
 (54) **Produkt:** Stillaslås
 (51) **Klasse:** 25-04
 (73) **Innehaver:** Haki AB, Box 102, 28063 SIBBHULT, SE
 (72) **Designer:** Erik Bruch, c/o Haki AB, 28063 SIBBHULT, SE
 (30) **Prioritet:** 2006.01.10, EM, 000461728

(11) **Reg.nr.:** 079915
 (21) **Søkn.nr.:** 20060366
 (22) **Inngitt:** 2006.07.11
 (43) **Allm. tilgj.:** 2006.07.24
 (15) **Registrert:** 2006.09.28
 (45) **Kunngjort:** 2006.10.23
 (18) **Reg. gjelder til:** 2011.07.11
 (55) **Avbildning(er):**



1.1

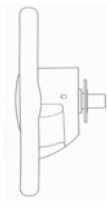

1.2



1.3



1.4



1.5



1.6



2.1

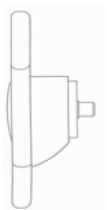

2.2



2.3



2.4

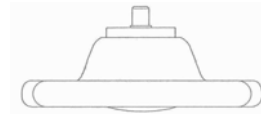

2.5



2.6



3.1

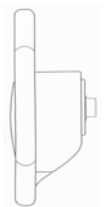

3.2

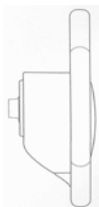

3.3



3.4



3.5



3.6



4.1

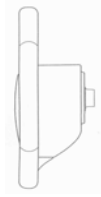

4.2

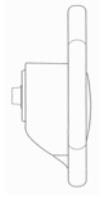

4.3

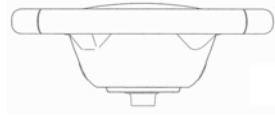

4.4



4.5



4.6



5.1

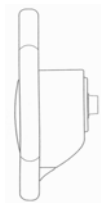

5.2



5.3



5.4



5.5



5.6



6.1

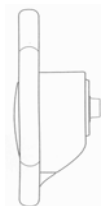

6.2



6.3



6.4



6.5



6.6

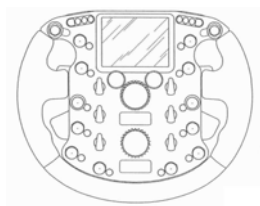

7.1

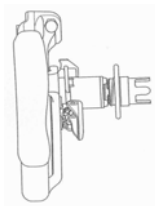

7.2

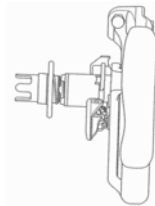

7.3

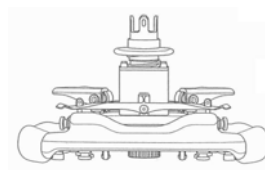

7.4

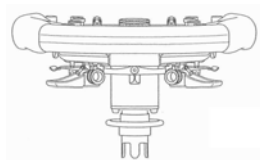

7.5

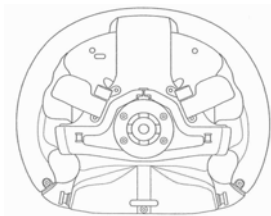

7.6

- (74) **Fullmektig:** Oslo Patentkontor AS, Postboks 7007 Majorstua, 0306 OSLO, NO
 (54) **Produkt:** 1-7. Ratt for leketøy, lekebiler og elektroniske spill
 (51) **Klasse:** 1-7. 21-01
 (73) **Innehaver:** Ferrari SpA, Via Emilia Est, 1163, 41100 MODENA, IT
 (72) **Designer:** Giuseppe Petrotta, Via Nuova Estense 609, 41053 MARANELLO (MODENA), IT
 Sergio Borsari, Via Verdi 9, 41051 CASTELNUOVO RANGONE (MODENA), IT
 Patrizio Moruzzi, Via Valdossola 20, 40134 BOLOGNA, IT
 Maurizio Manfredini, Via Canaletto 13, 41053 MARANELLO (MODENA), IT
 Aldo Costa, Largo Mercantini 7, 43100 PARMA, IT
- (30) **Prioritet:** 2006.01.24, EM, 000468392
 (60) **Anmerkning:** Registreringen gjelder samregistrering.

- (11) **Reg.nr.:** 079916
- (21) **Søkn.nr.:** 20060352
- (22) **Inngitt:** 2006.06.30
- (43) **Allm. tilgj.:** 2006.07.25
- (15) **Registrert:** 2006.09.28
- (45) **Kunngjort:** 2006.10.23
- (18) **Reg. gjelder til:** 2011.06.30
- (55) **Avbildning(er):**



1.1



1.2



1.3



1.4



1.5



1.6

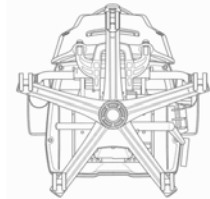

1.7



2.1



2.2

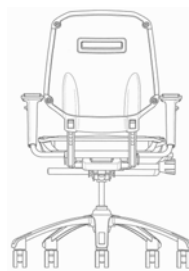

2.3



2.4



2.5



2.6

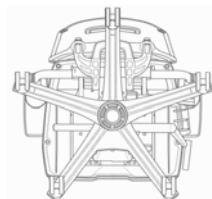

2.7



3.1



3.2



3.3



3.4



3.5

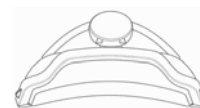

3.6



3.7

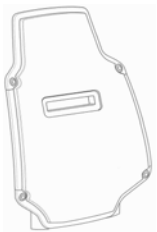

4.1

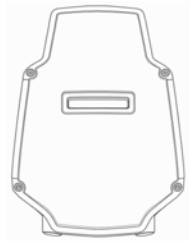

4.2



4.3



4.4



4.5



4.6



4.7



5.1



5.2



5.3



5.4



5.5



5.6

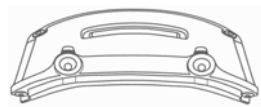

5.7



6.1



6.2



6.3



6.4



6.5

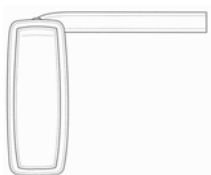

6.6

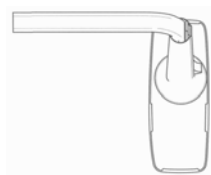

6.7



7.1

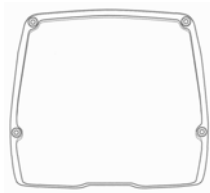

7.2

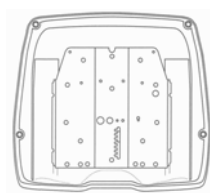

7.3



7.4



7.5



7.6



7.7

- (74) **Fullmektig:** Oslo Patentkontor AS, Postboks 7007 Majorstua, 0306 OSLO, NO
 (54) **Produkt:** 1-2. Stol
 3. Hodestøtte til stol
 4-5. Stolrygg
 6. Armlene til stol
 7. Stolsete
 (51) **Klasse:** 1-2. 06-01
 3-6. 06-06
 7. 06-01; 06-06
 (73) **Innehaver:** Ergonomiprodukter i Bodafors AB, Box 294, 57123 NÄSSJÖ, SE
 (72) **Designer:** Mårten Rittfeldt, Stefan Löfvings väg 5, 23931 SKANOR, SE
 Oskar Ponnert, Stålhölmögatan 3B, 21374 MALMÖ, SE
 (30) **Prioritet:** 2006.01.25, EM, 000468046
 (60) **Anmerking:** Registreringen gjelder samregistrering.

- (11) **Reg.nr.:** 079917
 (21) **Søkn.nr.:** 20060150
 (22) **Inngitt:** 2006.03.20
 (43) **Allm. tilgj.:** 2006.09.06
 (15) **Registrert:** 2006.09.28
 (45) **Kunngjort:** 2006.10.23
 (18) **Reg. gjelder til:** 2011.03.20
 (55) **Avbildning(er):**

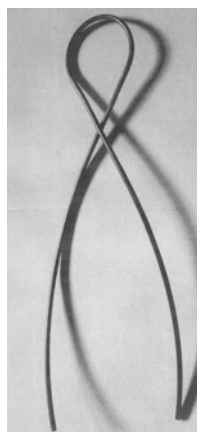

- (54) **Produkt:** Verktøy til bruk ved montering av panel
 (51) **Klasse:** 08-05
 (73) **Innehaver:** Jonny Bengtsson, Hängesten 1, 66894 BÄCKEFORS, SE
 (72) **Designer:** Jonny Bengtsson, Hängesten 1, 66894 BÄCKEFORS, SE
 (30) **Prioritet:** 2006.03.06, SE, 060152

- (11) **Reg.nr.:** 079918
- (21) **Søkn.nr.:** 20060154
- (22) **Inngitt:** 2006.03.24
- (43) **Allm. tilgj.:** 2006.04.28
- (15) **Registrert:** 2006.09.29
- (45) **Kunngjort:** 2006.10.23
- (18) **Reg. gjelder til:** 2011.03.24
- (55) **Avbildning(er):**



1.1



1.2



1.3

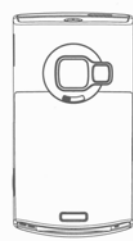

1.4

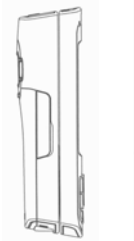

1.5



1.6

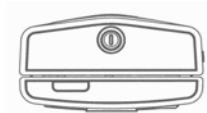

1.7



1.8



1.9



1.10



1.11



1.12



1.13



2.1



2.2



3.1

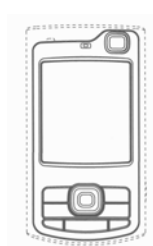

3.2



4.1



4.2



4.3



4.4



4.5



4.6



4.7

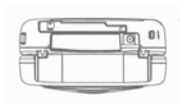

4.8



4.9



4.10



4.11



4.12



4.13



5.1



5.2



6.1



6.2

(74) **Fullmektig:**(54) **Produkt:**

Acapo AS, Postboks 1880 Nordnes, 5817 BERGEN, NO

1. Mobiltelefon

2. Tastaturarrangement til mobiltelefon

3. Detaljområde av mobiltelefon

4. Mobiltelefon

5-6. Tastaturarrangement til mobiltelefon

1-6. 14-03

(51) **Klasse:**(73) **Innehaver:**(72) **Designer:**

Nokia Corporation, Keilalahdentie 4, 02150 ESBO, FI

Anthony Dalby, Chandos Avenue 30, W54ER EALING, LONDON, GB

Jean-Marc Hering, Honkatie 4 B, 24160 SALO, FI

Ingve Holmung, 68 Ormonde Court, Upper Richmond Road, SW156TP LONDON, GB

(30) **Prioritet:**

2005.10.28, FI, 20050168 (design nr. 1, 2, 3, 4, 5)

2005.10.28, FI, 20050169 (design nr. 6)

(60) **Anmerkning:**

Registreringen gjelder samregistrering.

- (11) **Reg.nr.:** 079919
 (21) **Søkn.nr.:** 20060318
 (22) **Inngitt:** 2006.06.20
 (43) **Allm. tilgj.:** 2006.06.20
 (15) **Registrert:** 2006.09.29
 (45) **Kunngjort:** 2006.10.23
 (18) **Reg. gjelder til:** 2011.06.20
 (55) **Avbildning(er):**

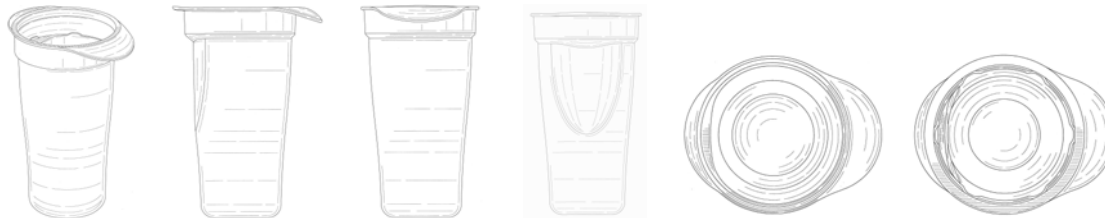

1.1

1.2

1.3

1.4

1.5

1.6

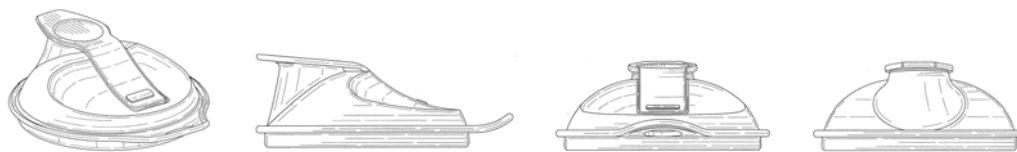

2.1

2.2

2.3

2.4

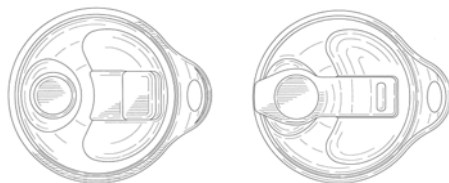

2.5

2.6



3.1

3.2

3.3

3.4

3.5

- (74) **Fullmektig:** Zacco Norway AS, Postboks 2003 Vika, 0125 OSLO, NO
 (54) **Produkt:** 1. Matryster-beholder
 2. Matryster-deksel
 3. Blandeinnsett for matryster
 (51) **Klasse:** 1-3. 07-01
 (73) **Innehaver:** Dart Industries Inc, 14901 S Orange Blossom Trail, FL32837 ORLANDO, US
 (72) **Designer:** Jan-Hendrik de Groot, 43, rue Jaques de Lalaing, 1040 BRUSSEL, BE
 (30) **Prioritet:** 2005.12.20, US, 29/245,170 (design nr. 3)
 2005.12.20, US, 29/245,172 (design nr. 2)
 2005.12.20, US, 29/245,173 (design nr. 1)
 (60) **Anmerkning:** Registreringen gjelder samregistrering.

- (11) **Reg.nr.:** 079920
- (21) **Søkn.nr.:** 20060367
- (22) **Inngitt:** 2006.07.11
- (43) **Allm. tilgj.:** 2006.07.24
- (15) **Registrert:** 2006.09.29
- (45) **Kunngjort:** 2006.10.23
- (18) **Reg. gjelder til:** 2011.07.11
- (55) **Avbildning(er):**

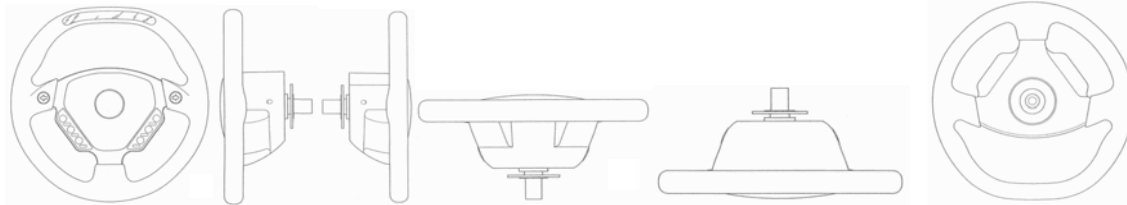

1.1 1.2 1.3 1.4 1.5 1.6

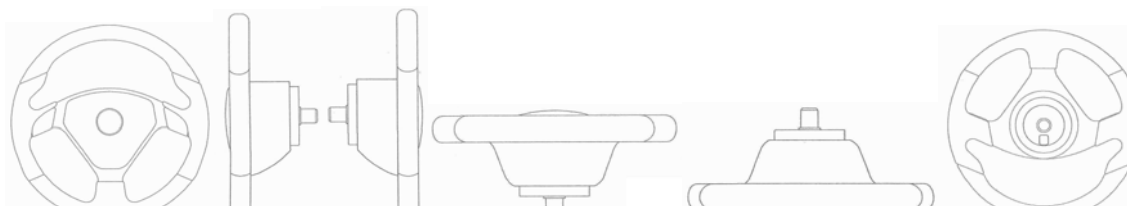

2.1 2.2 2.3 2.4 2.5 2.6

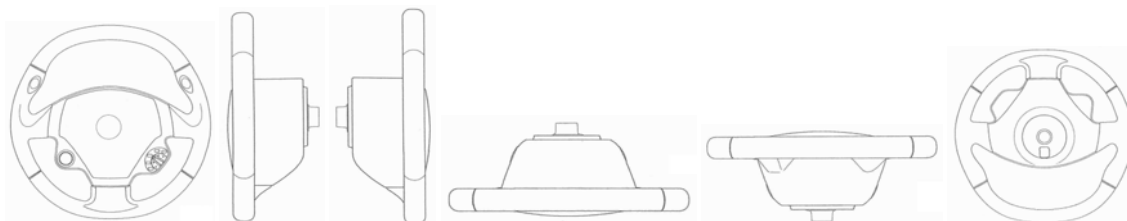

3.1 3.2 3.3 3.4 3.5 3.6

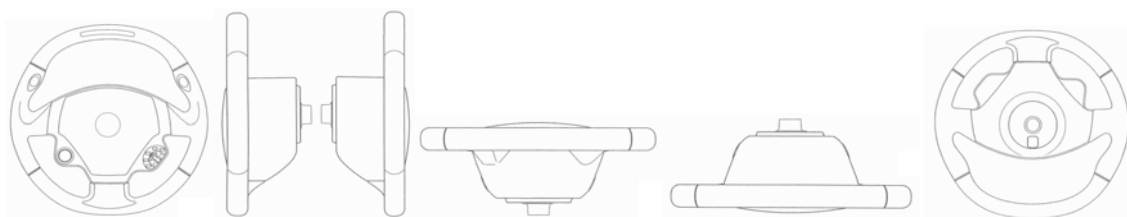

4.1 4.2 4.3 4.4 4.5 4.6

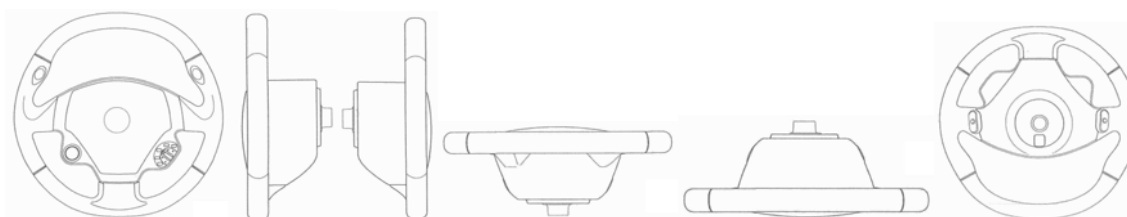

5.1 5.2 5.3 5.4 5.5 5.6

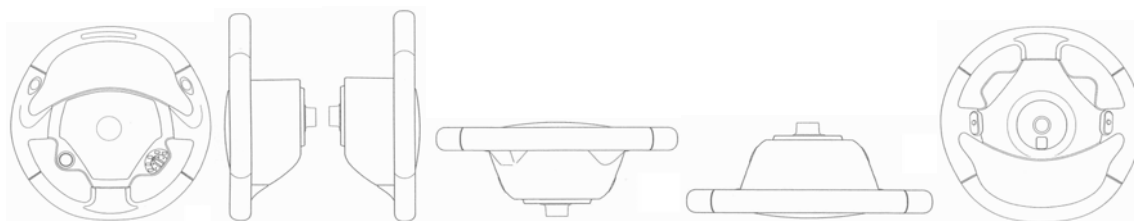

6.1

6.2

6.3

6.4

6.5

6.6

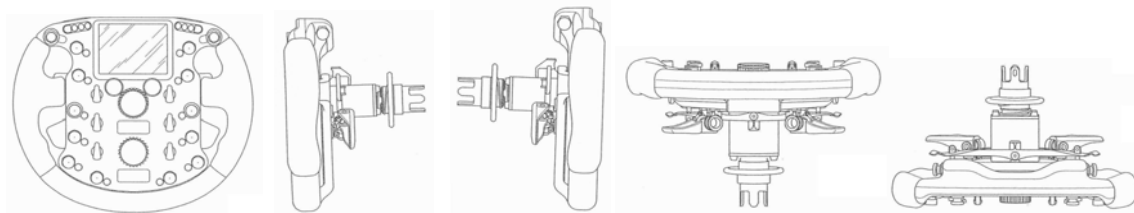

7.1

7.2

7.3

7.4

7.5

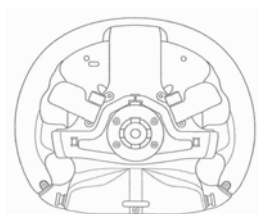

7.6

- (74) **Fullmektig:** Oslo Patentkontor AS, Postboks 7007 Majorstua, 0306 OSLO, NO
 (54) **Produkt:** 1-7. Ratt for kjøretøy
 (51) **Klasse:** 1-7. 12-16
 (73) **Innehaver:** Ferrari SpA, Via Emilia Est, 1163, 41100 MODENA, IT
 (72) **Designer:** Giuseppe Petrotta, Via Nuova Estense 609, 41053 MARANELLO (MODENA), IT
 Sergio Borsari, Via Verdi 9, 41051 CASTELNUOVO RANGONE (MODENA), IT
 Patrizio Moruzzi, Via Valdossola 20, 40134 BOLOGNA, IT
 Maurizio Manfredini, Via Canaletto 13, 41053 MARANELLO (MODENA), IT
 Aldo Costa, Largo Mercantini 7, 43100 PARMA, IT
- (30) **Prioritet:** 2006.01.24, EM, 000468392
 (60) **Anmerkning:** Registreringen gjelder samregistrering.

(11) **Reg.nr.:** 079921
(21) **Søkn.nr.:** 20050738
(22) **Inngitt:** 2005.12.20
(43) **Allm. tilgj.:** 2005.12.21
(15) **Registrert:** 2006.09.29
(45) **Kunngjort:** 2006.10.23
(18) **Reg. gjelder til:** 2010.12.20
(55) **Avbildning(er):**

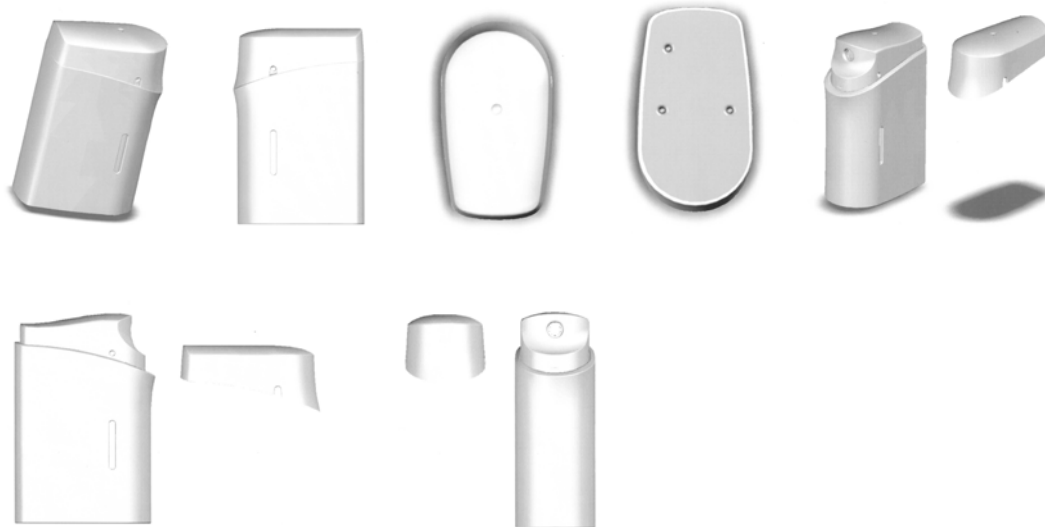

(74) **Fullmektig:** Bryn Aarflot AS, Postboks 449 Sentrum, 0104 OSLO, NO
(54) **Produkt:** Farmasøytisk dispenseringsanordning
(51) **Klasse:** 09-03
(73) **Innehaver:** Arakis Ltd, Chesterford Research Park, Little Chesterford, CB101XL SAFFRON WALDEN, ESSEX, GB
(72) **Designer:** Terry William Gander, c/o Industrial Design Consultancy Ltd, The Portland Business Centre, SL39EG BERKSHIRE, GB
Dimitrious Scoutas, c/o Industrial Design Consultancy Ltd, The Portland Business Centre, SL39EG BERKSHIRE, GB
(30) **Prioritet:** 2005.06.21, EM, 000367305

- (11) **Reg.nr.:** 079922
- (21) **Søkn.nr.:** 20060177
- (22) **Inngitt:** 2006.04.06
- (43) **Allm. tilgj.:** 2006.04.07
- (15) **Registrert:** 2006.09.29
- (45) **Kunngjort:** 2006.10.23
- (18) **Reg. gjelder til:** 2011.04.06
- (55) **Avbildning(er):**



1.1



1.2



1.3



1.4



1.5



1.6



1.7



1.8



1.9



1.10



1.11



2.1



2.2



3.1



3.2



3.3

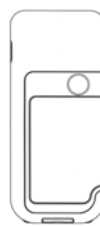

3.4



3.5



3.6



3.7



3.8



4.1



4.2



4.3

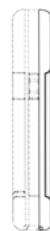

4.4

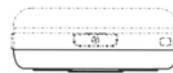

4.5



4.6



5.1

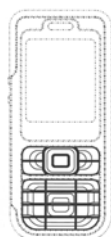

5.2

(74) **Fullmektig:**(54) **Produkt:**

Acapo AS, Postboks 1880 Nordnes, 5817 BERGEN, NO

1. Mobiltelefon

2. Tastaturområde for mobiltelefon

3. Mobiltelefon

4. Frontdel av mobiltelefon

5. Tastaturarrangement for mobiltelefon

(51) **Klasse:**

1-5. 14-03

(73) **Innehaver:**

Nokia Corporation, Keilalahdentie 4, 02150 ESBO, FI

(72) **Designer:**

Tej Chauhan, 109 Beverly Drive, HA85NH EDGWARE, MIDDLESEX, GB

Tanja Fisher, 40 B Strawberry Hill Road, TW14PU TWICKENHAM, MIDDLESEX, GB

Totti Helin, Köydenpunojankatu 7B 21, 00180 HELSINGFORS, FI

Grace Boicel, 105a Sheen Lane, SW148AE LONDON, GB

Dimitre D Mehandjiysky, 3535 East 1st Street, CA90803 BELMONT SHORE, US

Valérie Pegon, 3B Sheen Lane, SW148HY EAST SHEEN, LONDON, GB

(30) **Prioritet:**

2005.10.07, US, 29/240,007 (design nr. 3, 4,5)

2005.10.07, US, 29/240,009 (design nr. 1, 2)

(60) **Anmerkning:**

Registreringen gjelder samregistrering.

(11) Reg.nr.:	079923
(21) Søkn.nr.:	20060094
(22) Inngitt:	2006.02.16
(43) Allm. tilgj.:	2006.08.16
(15) Registrert:	2006.09.29
(45) Kunngjort:	2006.10.23
(18) Reg. gjelder til:	2011.02.16
(55) Avbildning(er):	



(54) Produkt:	Arbeidsstol med monitor og tastatur
(51) Klasse:	06-01, 14-02
(73) Innehaver:	Knut Anders Lødengen Ring, Seljeveien 16 D, 1890 RAKKESTAD, NO
(72) Designer:	Knut Anders Lødengen Ring, Seljeveien 16 D, 1890 RAKKESTAD, NO
(60) Anmerkning:	Registreringen er i farger.

- (11) **Reg.nr.:** 079924
(21) **Søkn.nr.:** 20060137
(22) **Inngitt:** 2006.03.10
(43) **Allm. tilgj.:** 2006.09.10
(15) **Registrert:** 2006.09.29
(45) **Kunngjort:** 2006.10.23
(18) **Reg. gjelder til:** 2011.03.10
(55) **Avbildning(er):**

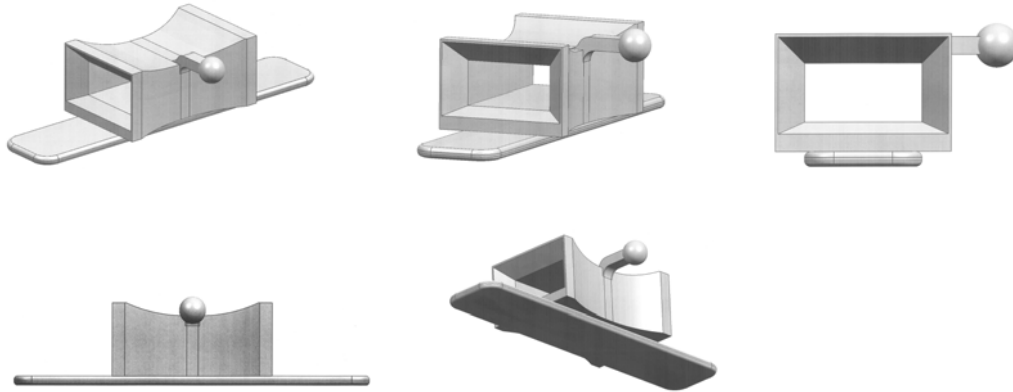

- (54) **Produkt:** Spesialrør til feste av tannreguleringswire
(51) **Klasse:** 24-02
(73) **Innehaver:** Swadesh Kumar, Utsiktsvn 36, 2208 KONGSVINGER, NO
(72) **Designer:** Swadesh Kumar, Utsiktsvn 36, 2208 KONGSVINGER, NO
Nils Kristian Kumar, Utsiktsveien 36, 2208 KONGSVINGER, NO
Sara Kumar, Utsiktsveien 36, 2208 KONGSVINGER, NO
Theresa Kumar, Sognsvn 21, 0851 OSLO, NO

(11) **Reg.nr.:** 079925
(21) **Søkn.nr.:** 20050515
(22) **Inngitt:** 2005.09.19
(43) **Allm. tilgj.:** 2005.12.01
(15) **Registrert:** 2006.10.02
(45) **Kunngjort:** 2006.10.23
(18) **Reg. gjelder til:** 2010.09.19
(55) **Avbildning(er):**

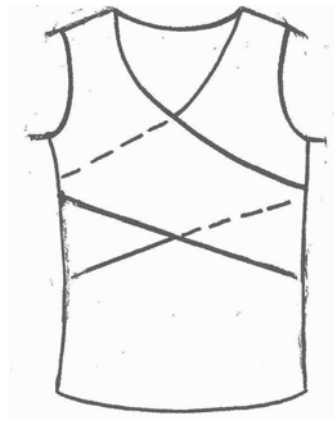
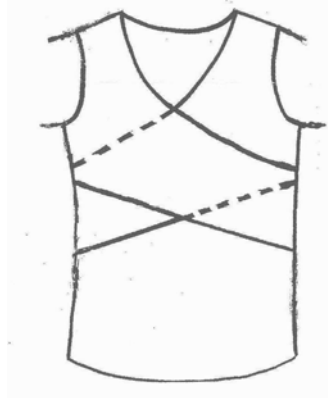

(74) **Fullmektig:** Plougmann & Vingtoft, Postboks 1003 Sentrum, 0104 OSLO, NO
(54) **Produkt:** Del av ammeklær
(51) **Klasse:** 02-02
(73) **Innehaver:** Paola Maria Friberg, Tranåsvägen 22, 27031 ÄSPERÖD, SE
(72) **Designer:** Paola Maria Friberg, Tranåsvägen 22, 27031 ÄSPERÖD, SE

(11) **Reg.nr.:** 079926
 (21) **Søkn.nr.:** 20060082
 (22) **Inngitt:** 2006.02.08
 (43) **Allm. tilgj.:** 2006.02.09
 (15) **Registrert:** 2006.10.02
 (45) **Kunngjort:** 2006.10.23
 (18) **Reg. gjelder til:** 2011.02.08
 (55) **Avbildning(er):**



1.1



2.1



3.1

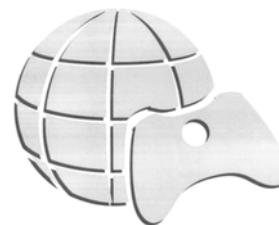

4.1



5.1

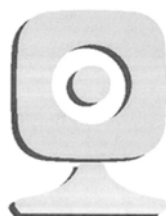

6.1



7.1

(74) **Fullmektig:** Bryn Aarflot AS, Postboks 449 Sentrum, 0104 OSLO, NO
 (54) **Produkt:** 1-7. Ikon for fremvisningsskjerm
 (51) **Klasse:** 1-7. 14-04
 (73) **Innehaver:** Microsoft Corp, One Microsoft Way, WA98052-6399 REDMOND, US
 (72) **Designert:** Shelley Armstrong, c/o Microsoft Corp, One Microsoft Way, WA98052 REDMOND, US
 Corey Marion, c/o The Iconfactory, 7204 West Friendly Ave, Bldg 2, Unit F, NC27410-6211 GREENSBORO, US
 David Lanham, c/o The Iconfactory, 7204 West Friendly Ave, Bldg 2, Unit F, NC27410-6211 GREENSBORO, US
 Travis Zuker, c/o The Iconfactory, 7204 West Friendly Ave, Bldg 2, Unit F, NC27410-6211 GREENSBORO, US
 Nino Yuniardi, c/o Microsoft Corp, One Microsoft Way, WA98052 REDMOND, US
 Paolo Malabuyo, c/o Microsoft Corp, One Microsoft Way, WA98052 REDMOND, US
 (30) **Prioritet:** 2005.08.09, US, 29/235,893 (design nr. 1)
 2005.08.09, US, 29/235,894 (design nr. 2)
 2005.08.09, US, 29/235,895 (design nr. 3, 7)
 2005.08.09, US, 29/235,896 (design nr. 4)
 2005.08.09, US, 29/335,987 (design nr. 5)
 2005.08.10, US, 29/235,988 (design nr. 6)
 (60) **Anmerkning:** Registreringen gjelder samregistrering.

(11)	Reg.nr.:	079927
(21)	Søkn.nr.:	20060329
(22)	Inngitt:	2006.06.26
(43)	Allm. tilgj.:	2006.07.19
(15)	Registrert:	2006.10.02
(45)	Kunngjort:	2006.10.23
(18)	Reg. gjelder til:	2011.06.26
(55)	Avbildning(er):	

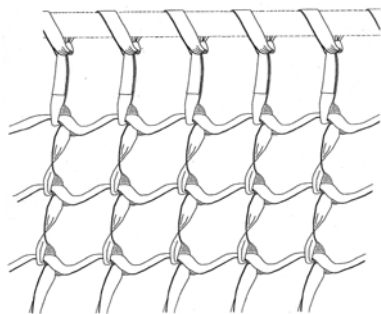

1.1

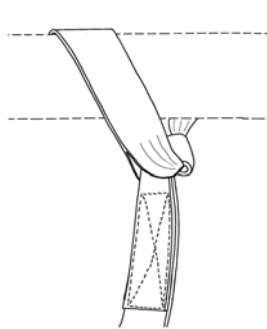

Detaljutsnitt

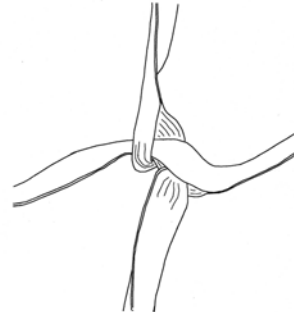

Detaljutsnitt

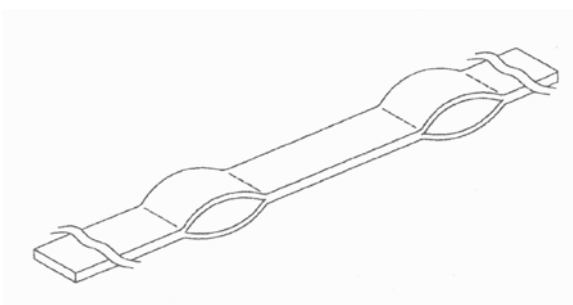

2.2

(74)	Fullmektig:	Curo AS, Industriveien 53, 7080 HEIMDAL, NO
(54)	Produkt:	1. Sikkerhetsnett 2. Bånd for sikkerhetsnett
(51)	Klasse:	1-2. 29-02
(73)	Innehaver:	A-Laskuvarjo Oy, PI 130, 01801 KLAUKKALA, FI
(72)	Designer:	Jarmo Uotila, Verkkomäentie 35, 01830 LEPSÄMÄ, FI
(30)	Prioritet:	2006.01.19, FI, 20060017
(60)	Anmerkning:	Registreringen gjelder samregistrering.

- (11) **Reg.nr.:** 079928
 (21) **Søkn.nr.:** 20060346
 (22) **Inngitt:** 2006.06.30
 (43) **Allm. tilgj.:** 2006.08.03
 (15) **Registrert:** 2006.10.02
 (45) **Kunngjort:** 2006.10.23
 (18) **Reg. gjelder til:** 2011.06.30
 (55) **Avbildning(er):**



1.1

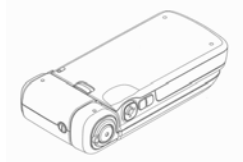

1.2



1.3



1.4



1.5



1.6



1.7

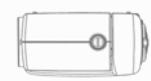

1.8



1.9



1.10



1.11



1.12



1.13



1.14



1.15



1.16



2.1



2.2



3.1



3.2

- (74) **Fullmektig:** Acapo AS, Postboks 1880 Nordnes, 5817 BERGEN, NO
 (54) **Produkt:** 1. Mobiltelefon
 2. Tastaturarrangement for mobiltelefon
 3. Tastaturområde for mobiltelefon
 (51) **Klasse:** 1-3. 14-03
 (73) **Innehaver:** Nokia Corporation, Keilalahdentie 4, 02150 ESBO, FI
 (72) **Designer:** Shunjiro Eguchi, Otavantie 3 A 25, 00200 HELSINGFORS, FI
 (30) **Prioritet:** 2006.02.03, FI, 20060026
 (60) **Anmerkning:** Registreringen gjelder samregistrering.

- (11) **Reg.nr.:** 079929
(21) **Søkn.nr.:** 20060333
(22) **Inngitt:** 2006.06.27
(43) **Allm. tilgj.:** 2006.06.27
(15) **Registrert:** 2006.10.03
(45) **Kunngjort:** 2006.10.23
(18) **Reg. gjelder til:** 2011.06.27
(55) **Avbildning(er):**



Detaljutsnitt

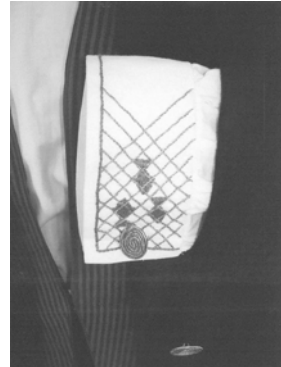

Detaljutsnitt

- (54) **Produkt:** Festdrakt
(51) **Klasse:** 02-02
(73) **Innehaver:** Rigmor Nøstvik, Gillesvåg, 8056 SALTSTRAUMEN, NO
(72) **Designer:** Rigmor Nøstvik, Gillesvåg, 8056 SALTSTRAUMEN, NO

(11) **Reg.nr.:** 079930
 (21) **Søkn.nr.:** 20050536
 (22) **Inngitt:** 2005.09.27
 (43) **Allm. tilgj.:** 2005.09.30
 (15) **Registrert:** 2006.10.03
 (45) **Kunngjort:** 2006.10.23
 (18) **Reg. gjelder til:** 2010.09.27
 (55) **Avbildning(er):**

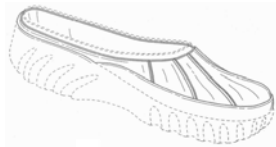

1.1

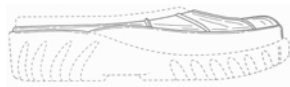

1.2

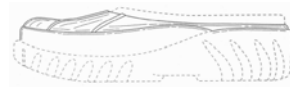

1.3

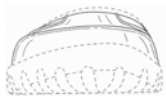

1.4

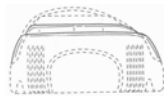

1.5

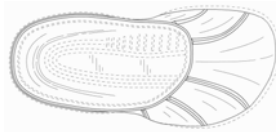

1.6



1.7



2.1



2.2



2.3



2.4



2.5



2.6



2.7

(74) **Fullmektig:** Bryn Aarflot AS, Postboks 449 Sentrum, 0104 OSLO, NO
 (54) **Produkt:** 1-2. Fottøyoverdel
 (51) **Klasse:** 1-2. 02-04
 (73) **Innehaver:** Crocs Inc, 6273 Monarch Park Place, CO80503 NIWOT, US
 (72) **Designer:** Scott Seamans, 7430 Clubhouse Road, CO80301 BOULDER, US
 (30) **Prioritet:** 2005.03.31, US, 29/226,792 (design nr. 2)
 2005.03.31, US, 29/226,856 (design nr. 1)
 (60) **Anmerkning:** Registreringen gjelder samregistrering.

(11) Reg.nr.:	079931
(21) Søkn.nr.:	20060155
(22) Inngitt:	2006.03.24
(43) Allm. tilgj.:	2006.09.24
(15) Registrert:	2006.10.03
(45) Kunngjort:	2006.10.23
(18) Reg. gjelder til:	2011.03.24
(55) Avbildning(er):	



1.1



1.2



1.3



2.1



2.2

(74) Fullmektig:	Cegumark AB, Box 53047, 40014 GÖTEBORG, SE
(54) Produkt:	1. Verneutstyr til støvel 2. Støvel med verneutstyr
(51) Klasse:	1-2. 02-04
(73) Innehaver:	TST Sweden AB, Prästgatan 12, 51154 KINNA, SE
(72) Designer:	Jorgen Lillieroth, Gullbergsvagen 47, 51159 KINNA, SE
(60) Anmerkning:	Designene er i farger. Registreringen gjelder samregistrering.

- (11) **Reg.nr.:** 079932
- (21) **Søkn.nr.:** 20050643
- (22) **Inngitt:** 2005.11.07
- (43) **Allm. tilgj.:** 2006.05.07
- (15) **Registrert:** 2006.10.03
- (45) **Kunngjort:** 2006.10.23
- (18) **Reg. gjelder til:** 2010.11.07
- (55) **Avbildning(er):**



1.1



1.2



1.3



1.4



2.1



2.2



2.3



3.1



3.2



3.3



3.4



3.5



4.1

- (74) **Fullmektig:** Onsagers AS, Postboks 6963 St Olavs Plass, 0130 OSLO, NO
- (54) **Produkt:**
1. Beholder for farmasøytiske og kosmetiske produkter
 2. Tube for farmasøytiske produkter og kosmetiske produkter
 3. Eske for farmasøytiske produkter og kosmetiske produkter
 4. Ornamert for emballasje
- (51) **Klasse:**
1. 09-03
 2. 09-05
 3. 09-03
 4. 09-03, 09-05
- (73) **Innehaver:** Biotec Pharmacon ASA, Strandgata 3, 9008 TROMSØ, NO
- (72) **Designer:** Tank Design Tromsø AS, Postboks 751, 9258 TROMSØ, NO
Margrete Lund, Sverdrupsgate 26, 0559 OSLO, NO
- (60) **Anmerkning:** Designene er i farger.
Registreringen gjelder samregistrering.
-

- (11) **Reg.nr.:** 079933
- (21) **Søkn.nr.:** 20060271
- (22) **Inngitt:** 2006.05.29
- (43) **Allm. tilgj.:** 2006.05.30
- (15) **Registrert:** 2006.10.03
- (45) **Kunngjort:** 2006.10.23
- (18) **Reg. gjelder til:** 2011.05.29
- (55) **Avbildning(er):**

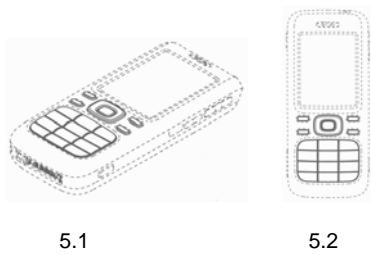
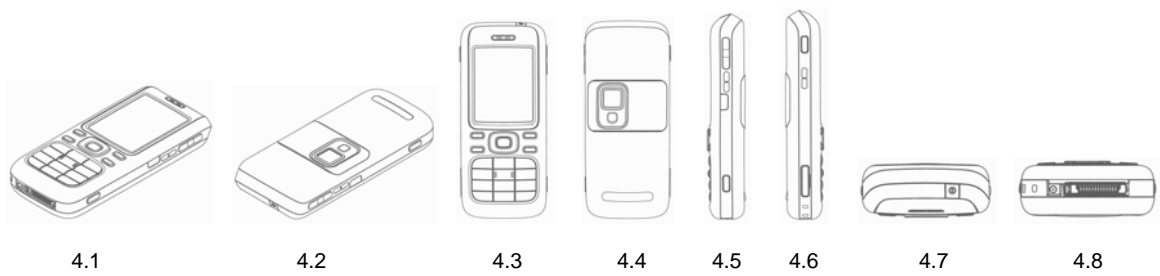
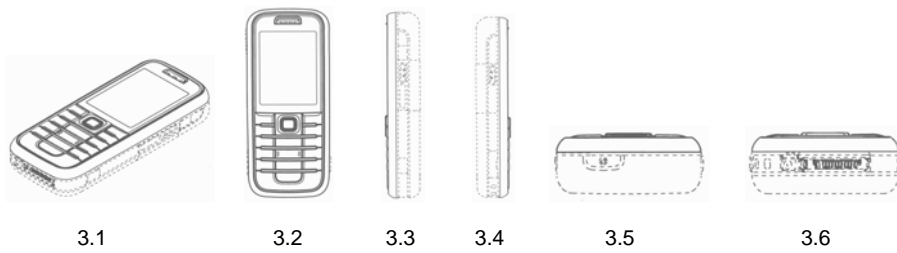
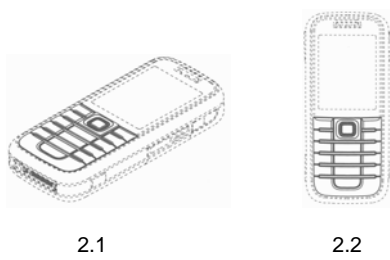
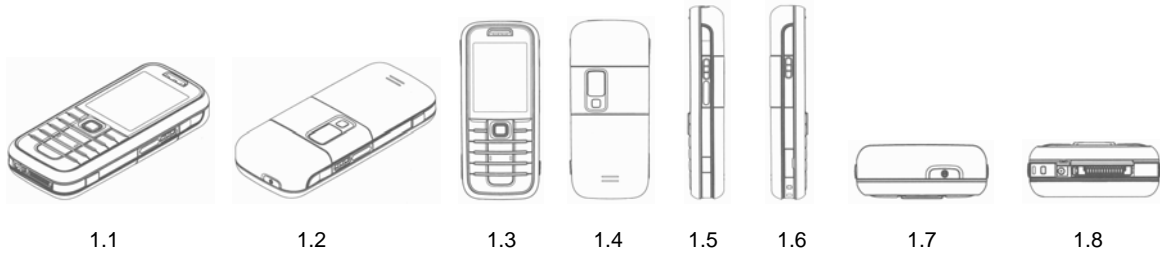



6.1



6.2



6.3



6.4



6.5



6.7

(74) **Fullmektig:**(54) **Produkt:**

Acapo AS, Postboks 1880 Nordnes, 5817 BERGEN, NO

1. Mobiltelefon

2. Tastaturområde for mobiltelefon

3. Frontdel av mobiltelefon

4. Mobiltelefon

5. Tastaturarrangement for mobiltelefon

6. Frontdel av mobiltelefon

(51) **Klasse:**

1-6. 14-03

(73) **Innehaver:**

Nokia Corporation, Keilalahdentie 4, 02150 ESBO, FI

(72) **Designer:**

Wei-Jong William Sheu, 7852 Vicky Avenue, CA91304 WEST HILLS, US

Duncan Burns, #203 18645 Hatteras Street, CA91356 TARZANA, US

Edward Mitchell, Nørre Farimagsgade 1, 1 t v, 1364 KØBENHAVN K, DK

(30) **Prioritet:**

2005.11.30, US, 29/243,708 (design nr. 1, 2, 3)

2005.11.30, US, 29/243,710 (design nr. 4, 5, 6)

(60) **Anmerkning:**

Registreringen gjelder samregistrering.

(11) **Reg.nr.:** 079934
 (21) **Søkn.nr.:** 20060355
 (22) **Inngitt:** 2006.07.04
 (43) **Allm. tilgj.:** 2006.07.18
 (15) **Registrert:** 2006.10.04
 (45) **Kunngjort:** 2006.10.23
 (18) **Reg. gjelder til:** 2011.07.04
 (55) **Avbildning(er):**

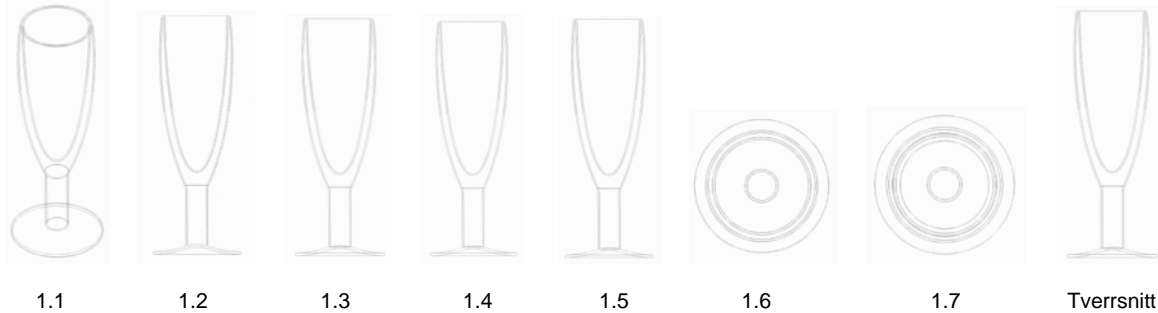

(74) **Fullmektig:** Acapo AS, Postboks 1880 Nordnes, 5817 BERGEN, NO
 (54) **Produkt:** 1. Champagneglass
 2. Vinglass
 (51) **Klasse:** 1-2. 07-01
 (73) **Innehaver:** PI-Design AG, Postfach 463, 6234 TRIENGEN, CH
 (72) **Designer:** Jørgen Bodum, St Niklausenstrasse 23, 6005 ST NIKLAUSEN, CH
 (30) **Prioritet:** 2006.01.18, DK, 2006 00019
 (60) **Anmerkning:** Registreringen gjelder samregistrering.

- (11) **Reg.nr.:** 079935
(21) **Søkn.nr.:** 20060356
(22) **Inngitt:** 2006.07.04
(43) **Allm. tilgj.:** 2006.07.16
(15) **Registrert:** 2006.10.04
(45) **Kunngjort:** 2006.10.23
(18) **Reg. gjelder til:** 2011.07.04
(55) **Avbildning(er):**

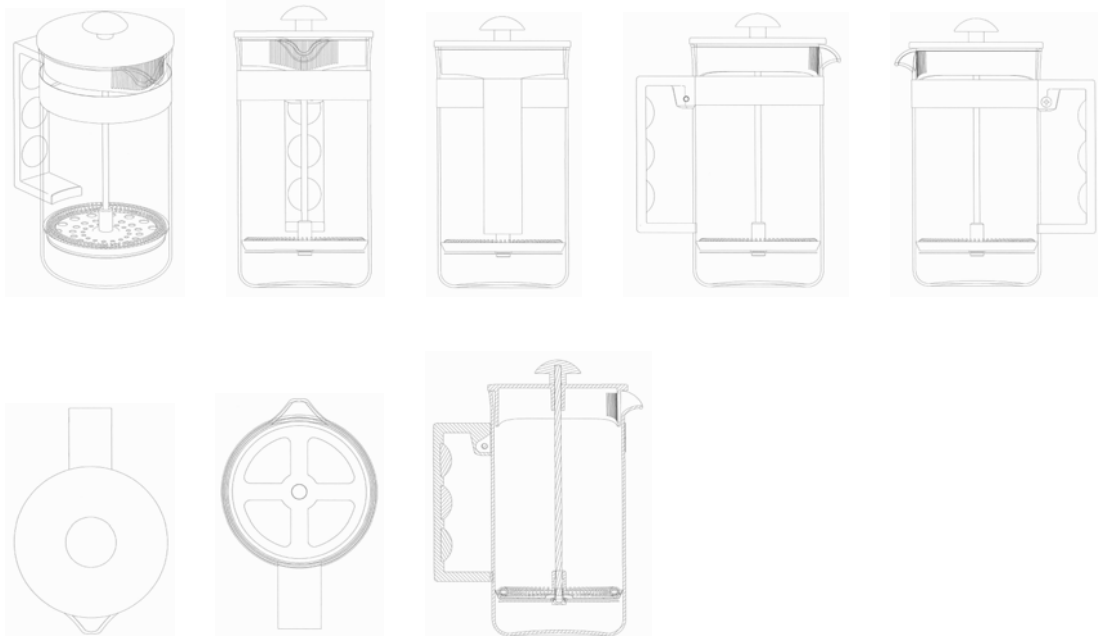

Tverrsnitt

- (74) **Fullmektig:** Acapo AS, Postboks 1880 Nordnes, 5817 BERGEN, NO
(54) **Produkt:** Kaffetrakter/presskanne
(51) **Klasse:** 07-02
(73) **Innehaver:** PI-Design AG, Postfach 463, 6234 TRIENGEN, CH
(72) **Designer:** Jørgen Bodum, St Niklausenstrasse 23, 6005 ST NIKLAUSEN, CH
(30) **Prioritet:** 2006.01.16, DK, 2006 00015

(11) **Reg.nr.:** 079936
(21) **Søkn.nr.:** 20060357
(22) **Inngitt:** 2006.07.04
(43) **Allm. tilgj.:** 2006.07.15
(15) **Registrert:** 2006.10.04
(45) **Kunngjort:** 2006.10.23
(18) **Reg. gjelder til:** 2011.07.04
(55) **Avbildning(er):**



Tverrsnitt

(74) **Fullmektig:** Acapo AS, Postboks 1880 Nordnes, 5817 BERGEN, NO
(54) **Produkt:** Glass
(51) **Klasse:** 07-01
(73) **Innehaver:** PI-Design AG, Postfach 463, 6234 TRIENGEN, CH
(72) **Designer:** Jørgen Bodum, St Niklausenstrasse 23, 6005 ST NIKLAUSEN, CH
(30) **Prioritet:** 2006.01.15, DK, 2006 00013

- (11) **Reg.nr.:** 079937
- (21) **Søkn.nr.:** 20060389
- (22) **Inngitt:** 2006.07.31
- (43) **Allm. tilgj.:** 2006.07.31
- (15) **Registrert:** 2006.10.04
- (45) **Kunngjort:** 2006.10.23
- (18) **Reg. gjelder til:** 2011.07.31
- (55) **Avbildning(er):**

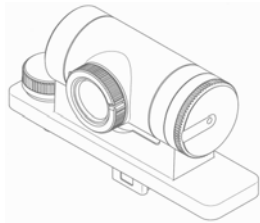

1.1

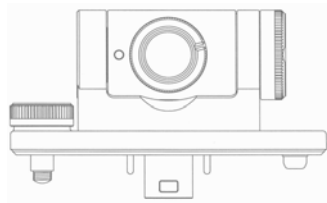

1.2

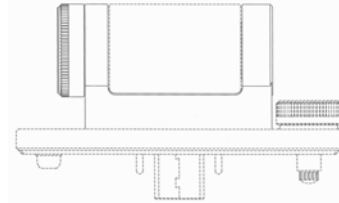

1.3

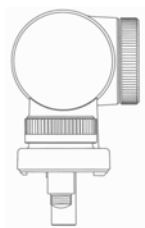

1.4

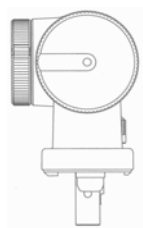

1.5

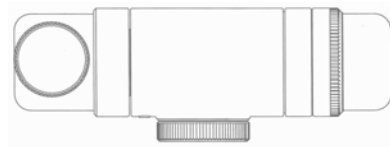

1.6

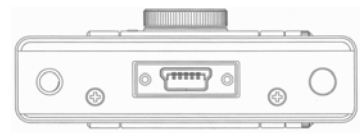

1.7

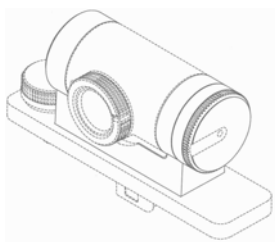

2.1

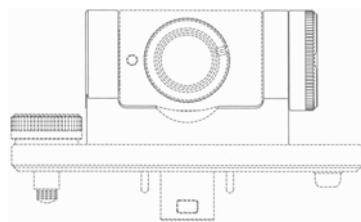

2.2

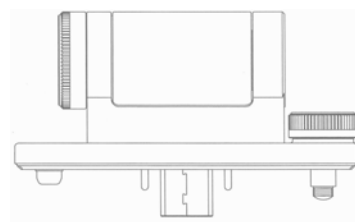

2.3

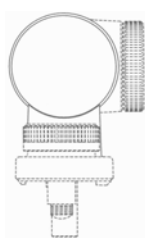

2.4

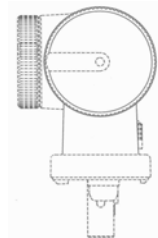

2.5

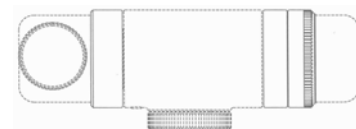

2.6

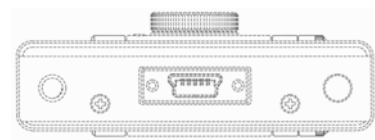

2.7

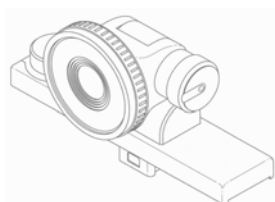

3.1

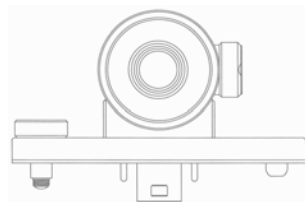

3.2

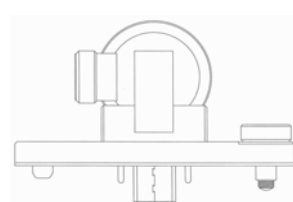

3.3



3.4



3.5

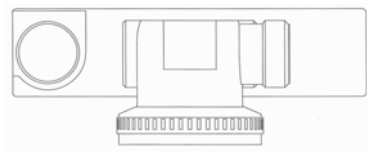

3.6

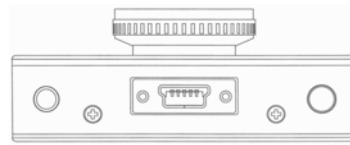

3.7

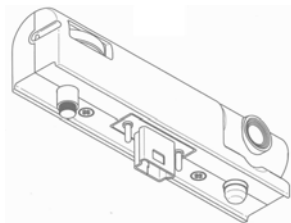

4.1



4.2

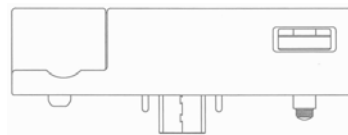

4.3

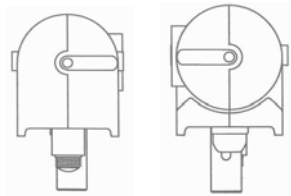

4.4

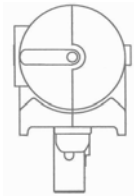

4.5



4.6

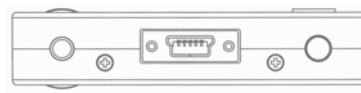

4.7

- (74) **Fullmektig:** Zacco Norway AS, Postboks 2003 Vika, 0125 OSLO, NO
 (54) **Produkt:** 1-4. Kamera
 (51) **Klasse:** 1-4. 16-01
 (73) **Innehaver:** Sony Computer Entertainment Inc, 2-6-21, Minami-Aoyama, Minato-ku, 107-0062 TOKYO, JP
 (72) **Designer:** Takatoshi Nakamura, c/o Sony Corp, 7-35, Kitashinagawa 6-chome, Shinagawa-ku TOKYO, JP
 (30) **Prioritet:** 2006.01.31, JP, 2006-2051 (design nr. 1)
 2006.01.31, JP, 2006-2052 (design nr. 2)
 2006.01.31, JP, 2006-2053 (design nr. 3)
 2006.01.31, JP, 2006-2054 (design nr. 4)
- (60) **Anmerkning:** Registreringen gjelder samregistrering.

(11) **Reg.nr.:** 079938
(21) **Søkn.nr.:** 20060391
(22) **Inngitt:** 2006.08.02
(43) **Allm. tilgj.:** 2006.08.06
(15) **Registrert:** 2006.10.04
(45) **Kunngjort:** 2006.10.23
(18) **Reg. gjelder til:** 2011.08.02
(55) **Avbildning(er):**

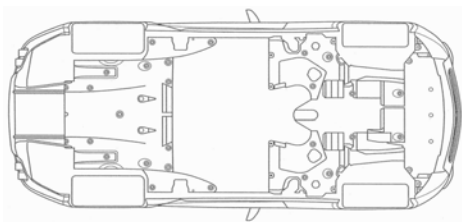
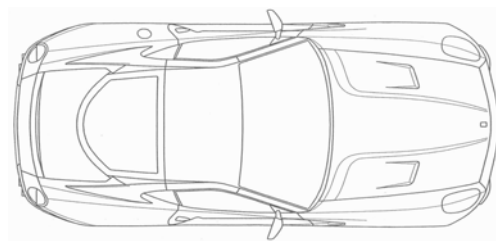
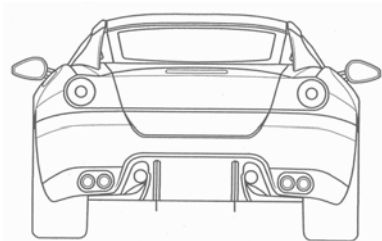
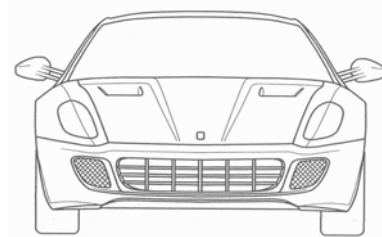
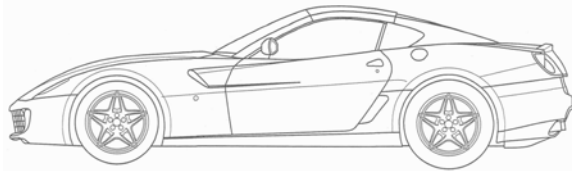
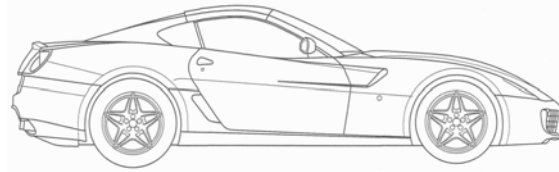
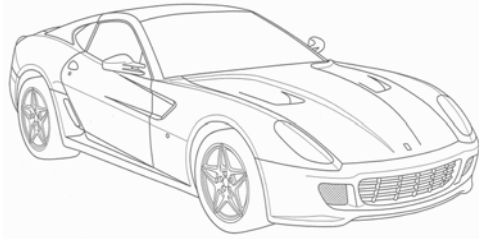

(74) **Fullmektig:** Oslo Patentkontor AS, Postboks 7007 Majorstua, 0306 OSLO, NO
(54) **Produkt:** Lekebil
(51) **Klasse:** 21-01
(73) **Innehaver:** Ferrari SpA, Via Emilia Est, 1163, 41100 MODENA, IT
(72) **Designer:** Maurizio Manfredini, Via Canaletto 13, 41053 MARANELLO (MODENA), IT
(30) **Prioritet:** 2006.02.06, EM, 000475124

- (11) **Reg.nr.:** 079939
 (21) **Søkn.nr.:** 20060158
 (22) **Inngitt:** 2006.03.27
 (43) **Allm. tilgj.:** 2006.09.27
 (15) **Registrert:** 2006.10.04
 (45) **Kunngjort:** 2006.10.23
 (18) **Reg. gjelder til:** 2011.03.27
 (55) **Avbildning(er):**



- (74) **Fullmektig:** Cegumark AB, Box 53047, 40014 GÖTEBORG, SE
 (54) **Produkt:** Vannsportvest med håndtak
 (51) **Klasse:** 29-02
 (73) **Innehaver:** Baltic Safety Products AB, Box 60, 54502 ÄLGARÅS, SE
 (72) **Designer:** Baltic Safety Products AB, Box 60, 54502 ÄLGARÅS, SE
 (60) **Anmerkning:** Designen er i farger.

- (11) **Reg.nr.:** 079940
 (21) **Søkn.nr.:** 20060151
 (22) **Inngitt:** 2006.03.21
 (43) **Allm. tilgj.:** 2006.09.21
 (15) **Registrert:** 2006.10.04
 (45) **Kunngjort:** 2006.10.23
 (18) **Reg. gjelder til:** 2011.03.21
 (55) **Avbildning(er):**



- (54) **Produkt:** Kniv og slire (sammenstilling)
 (51) **Klasse:** 03-01, 08-03
 (73) **Innehaver:** Knivklubben Trønderkniv, v/ Sverre J Stangenes Rødven, Jonsvannsveien 427, 7059 JAKOBSLI, NO
 (72) **Designer:** Knivklubben Trønderkniv, v/ Sverre J Stangenes Rødven, Jonsvannsveien 427, 7059 JAKOBSLI, NO
 (60) **Anmerkning:** Designen er i farger.
 Det er foretatt supplerende undersøkelse

Fornyelser

Reg.nr: 069883 Fornyhet til: 2011.04.04
Innehaver: Genzyme Corp, One Kendall Square, Cambridge, MA 02139, US
Fullmektig: Bryn Aarflot AS, Postboks 449 Sentrum, 0104 Oslo, NO

Reg.nr: 070209 Fornyhet til: 2011.10.24
Innehaver: Perstorp AB, S-284 80 Perstorp, SE
Fullmektig: Onsagers AS, Postboks 6963 St Olavs Plass, 0130 Oslo, NO

Reg.nr: 070411 Fornyhet til: 2011.10.30
Innehaver: Samsonite Corp, 11200 East 45th Avenue, Denver, CO 80239-3018, US
Fullmektig: Oslo Patentkontor AS, Postboks 7007 Majorstua, 0306 Oslo, NO

Reg.nr: 070623 Fornyhet til: 2011.10.09
Innehaver: Ferrero oHG mbH, Rheinstrasse 3-7, D-35260 Stadtallendorf, DE
Fullmektig: Curo AS, Industriveien 53, 7080 Heimdal, NO

Reg.nr: 070624 Fornyhet til: 2011.10.09
Innehaver: Ferrero oHG mbH, Rheinstrasse 3-7, D-35260 Stadtallendorf, DE
Fullmektig: Curo AS, Industriveien 53, 7080 Heimdal, NO

Reg.nr: 070767 Fornyhet til: 2011.10.14
Innehaver: Bristol-Myers Squibb Co, 345 Park Avenue, New York, NY 10154, US
Fullmektig: Bryn Aarflot AS, Postboks 449 Sentrum, 0104 Oslo, NO

Reg.nr: 070818 Fornyhet til: 2011.10.09
Innehaver: Colgate-Palmolive Co, 300 Park Avenue, New York, NY 10022, US
Fullmektig: Tandbergs Patentkontor AS, Postboks 7085 Majorstua, 0306 Oslo, NO

Reg.nr: 070819 Fornyhet til: 2011.10.09
Innehaver: Colgate-Palmolive Co, 300 Park Avenue, New York, NY 10022, US
Fullmektig: Tandbergs Patentkontor AS, Postboks 7085 Majorstua, 0306 Oslo, NO

Reg.nr: 072500 Fornyhet til: 2011.12.30
Innehaver: Colgate-Palmolive Co, 300 Park Avenue, New York, NY 10022, US
Fullmektig: Tandbergs Patentkontor AS, Postboks 7085 Majorstua, 0306 Oslo, NO

Reg.nr: 073588 Fornyhet til: 2011.10.09
Innehaver: Koninklijke Philips Electronics NV, Groenewoudseweg 1, Eindhoven, NL
Fullmektig: Zacco Norway AS, Postboks 765 Sentrum, 0106 Oslo, NO

Reg.nr: 073612 Fornyhet til: 2011.10.09
Innehaver: Koninklijke Philips Electronics NV, Groenewoudseweg 1, Eindhoven, NL
Fullmektig: Zacco Norway AS, Postboks 765 Sentrum, 0106 Oslo, NO

Reg.nr: 073650 Fornyhet til: 2011.10.09
Innehaver: Koninklijke Philips Electronics NV, Groenewoudseweg 1, Eindhoven, NL
Fullmektig: Zacco Norway AS, Postboks 765 Sentrum, 0106 Oslo, NO

Reg.nr: 073651 Fornyhet til: 2011.10.09
Innehaver: Koninklijke Philips Electronics NV, Groenewoudseweg 1, Eindhoven, NL
Fullmektig: Zacco Norway AS, Postboks 765 Sentrum, 0106 Oslo, NO

Reg.nr: 073652 Fornyhet til: 2011.10.09
Innehaver: Koninklijke Philips Electronics NV, Groenewoudseweg 1, Eindhoven, NL
Fullmektig: Zacco Norway AS, Postboks 765 Sentrum, 0106 Oslo, NO

Reg.nr: 073891 Fornyhet til: 2011.12.23
Innehaver: Astra AB, S-151 85 Södertälje, SE
Fullmektig: Zacco Norway AS, Postboks 765 Sentrum, 0106 Oslo, NO

Reg.nr: 073892 Fornyhet til: 2011.12.23
Innehaver: Astra AB, S-151 85 Södertälje, SE
Fullmektig: Zacco Norway AS, Postboks 765 Sentrum, 0106 Oslo, NO

Reg.nr: 073893 Fornyhet til: 2011.12.23
Innehaver: Astra AB, S-151 85 Södertälje, SE
Fullmektig: Zacco Norway AS, Postboks 765 Sentrum, 0106 Oslo, NO

Reg.nr: 073894 Fornyhet til: 2011.12.23
Innehaver: Astra AB, S-151 85 Södertälje, SE
Fullmektig: Zacco Norway AS, Postboks 765 Sentrum, 0106 Oslo, NO

Reg.nr: 073895 Fornyhet til: 2011.12.23
Innehaver: Astra AB, S-151 85 Södertälje, SE
Fullmektig: Zacco Norway AS, Postboks 765 Sentrum, 0106 Oslo, NO

Reg.nr: 073896 Fornyhet til: 2011.12.23
Innehaver: Astra AB, S-151 85 Södertälje, SE
Fullmektig: Zacco Norway AS, Postboks 765 Sentrum, 0106 Oslo, NO

Reg.nr: 073897 Fornyhet til: 2011.12.23
Innehaver: Astra AB, S-151 85 Södertälje, SE
Fullmektig: Zacco Norway AS, Postboks 765 Sentrum, 0106 Oslo, NO

Reg.nr: 073898 Fornyhet til: 2011.12.23
Innehaver: Astra AB, S-151 85 Södertälje, SE
Fullmektig: Zacco Norway AS, Postboks 765 Sentrum, 0106 Oslo, NO

Reg.nr: 073955 Fornyhet til: 2011.11.12
Innehaver: AstraZeneca AB, S-151 85 Södertälje, SE
Fullmektig: Oslo Patentkontor AS, Postboks 7007 Majorstua, 0306 Oslo, NO

Reg.nr: 077042 Fornyet til: 2011.10.05
Innehaver: Black & Decker Inc, Drummond Plaza Office Park, 1423 Kirkwood Highway, Newark, DE 19711, US
Fullmektig: Tandbergs Patentkontor AS, Postboks 7085 Majorstua, 0306 Oslo, NO

Reg.nr: 077339 Fornyet til: 2011.11.05
Innehaver: Funkwerk Enterprise Communications GmbH, Südwestpark 94, D-90449 Nürnberg, DE
Fullmektig: Tandbergs Patentkontor AS, Postboks 7085 Majorstua, 0306 Oslo, NO

Reg.nr: 077466 Fornyet til: 2011.10.04
Innehaver: GlaxoSmithKline Consumer Healthcare GmbH & Co KG, Bussmatten 1, D-77815 Buehl (Baden), DE
Fullmektig: Zacco Norway AS, Postboks 765 Sentrum, 0106 Oslo, NO

Reg.nr: 077499 Fornyet til: 2011.12.23
Innehaver: AstraZeneca AB, S-151 85 Södertälje, SE
Fullmektig: Awapatent AB, Box 5117, S-200 71 Malmö, SE

Reg.nr: 077609 Fornyet til: 2011.09.24
Innehaver: Fuchs Petrolub AG, Friesenheimer Str. 17, D-68169 Mannheim, DE
Fullmektig: Acapo AS, Postboks 1880 Nordnes, 5817 Bergen, NO

Reg.nr: 077611 Fornyet til: 2011.09.24
Innehaver: Fuchs Petrolub AG, Friesenheimer Str. 17, D-68169 Mannheim, DE
Fullmektig: Acapo AS, Postboks 1880 Nordnes, 5817 Bergen, NO

Reg.nr: 077612 Fornyet til: 2011.09.24
Innehaver: Fuchs Petrolub AG, Friesenheimer Str. 17, D-68169 Mannheim, DE
Fullmektig: Acapo AS, Postboks 1880 Nordnes, 5817 Bergen, NO